

SKY73023-11: 1700 – 2200 MHz High Gain and Linearity Diversity Downconversion Mixer

Applications

- 2G/3G base station transceivers:
 - GSM/EDGE, CDMA, UMTS/WCDMA, PHS
- Land mobile radio
- Wireless Local Loop
- High performance radio links
- Private mobile radio

Features

- Operating frequency range: 1700 to 2200 MHz
- IF frequency range: 40 to 300 MHz
- Conversion gain: 9.7 dB
- Input IP3: +25.7 dBm
- Output IP3: +35.4 dBm
- Noise figure: 9.9 dB
- Integrated LO drivers
- Integrated low loss RF baluns
- High linearity IF amplifiers
- On-chip SPDT LO switch (greater than 45 dB LO-to-LO isolation)
- Small, MCM (36-pin, 6 x 6 mm) Pb-free package (MSL3, 260 °C per JEDEC J-STD-020)

NEW Skyworks offers lead (Pb)-free RoHS (Restriction of Hazardous Substances) compliant packaging.



Description

The SKY73023-11 is a fully integrated diversity mixer that includes Local Oscillator (LO) drivers, an LO switch, high linearity mixers, and large dynamic range Intermediate Frequency (IF) amplifiers. Low loss RF baluns have also been included to reduce design complications and lower system cost.

The SKY73023-11 features an input IP3 of +25.7 dBm and a Noise Figure (NF) of 9.9 dB, making the device an ideal solution for high dynamic range systems such as 2G/3G base station receivers. The LO switch provides more than 45 dB of isolation between LO inputs and supports the switching time required for GSM/EDGE base stations.

The SKY73023-11 is manufactured using a robust silicon BiCMOS process and has been designed for optimum long-term reliability. The SKY73023-11 diversity downconversion mixer is provided in a compact, 36-pin 6 x 6 mm Multi-Chip Module (MCM). A functional block diagram is shown in Figure 1. The pin configuration and package are shown in Figure 2. Signal pin assignments and functional pin descriptions are provided in Table 1.

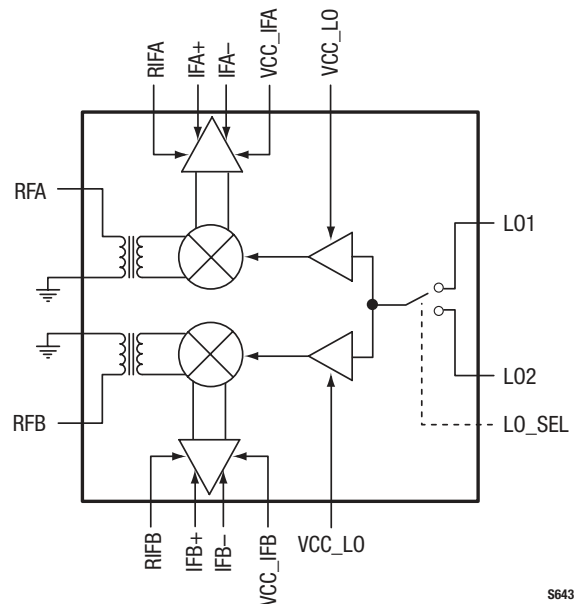

Figure 1. SKY73023-11 Block Diagram

S643

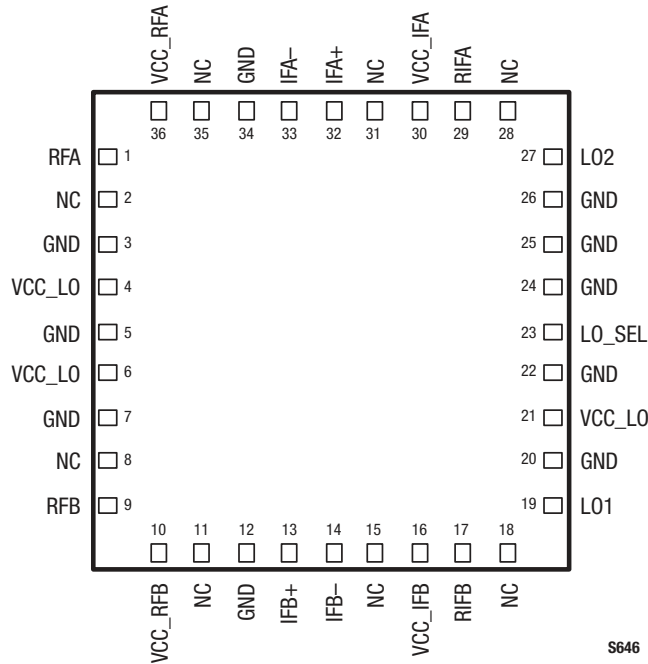

Figure 2. SKY73023-11 Pinout – 36-Pin MCM

Table 1. SKY73023-11 Signal Descriptions

Pin #	Name	Description	Pin #	Name	Description
1	RFA	Channel A RF input	19	LO1	Local oscillator 1 input
2	NC	No connect	20	GND	Ground
3	GND	Ground	21	VCC_LO	DC supply, +5 V
4	VCC_LO	DC supply, +5 V	22	GND	Ground
5	GND	Ground	23	LO_SEL	Local oscillator select switch control
6	VCC_LO	DC supply, +5 V	24	GND	Ground
7	GND	Ground	25	GND	Ground
8	NC	No connect	26	GND	Ground
9	RFB	Channel B RF input	27	LO2	Local oscillator 2 input
10	VCC_RFB	Channel B RF DC supply, +5 V	28	NC	No connect
11	NC	No connect	29	RIFA	Channel A IF bias adjust
12	GND	Ground	30	VCC_IFA	Channel A IF DC supply, +5 V
13	IFB+	Positive channel B IF output	31	NC	No connect
14	IFB-	Negative channel B IF output	32	IFA+	Positive channel A IF output
15	NC	No connect	33	IFA-	Negative channel A IF output
16	VCC_IFB	Channel B IF DC supply, +5 V	34	GND	Ground
17	RIFB	Channel B IF bias adjust	35	NC	No connect
18	NC	No connect	36	VCC_RFA	Channel A RF DC supply, +5 V

Functional Description

The SKY73023-11 is a high gain diversity mixer, optimized for base station receiver applications. The device consists of two diversity channels (A and B), each consisting of a low loss RF balun, high linearity passive mixer, and a low noise IF amplifier.

Two LO amplifiers (independent of channels A and B) are also included that allow the SKY73023-11 to connect directly to the output of a Voltage Controlled Oscillator (VCO). This eliminates the extra gain stages needed by most discrete passive mixers. A Single Pole, Double Throw (SPDT) switch has been included to select between two different LO inputs for frequency hopping applications (i.e., GSM).

RF Baluns and Passive Mixer

The RF baluns provide a single ended input, which can easily be matched to 50 Ω using a simple external matching circuit. The RF baluns offer very low loss, and excellent amplitude and phase balance.

The high linearity SKY73023-11 is a passive, double balanced mixer that provides a very low conversion loss and an excellent 3rd Order Input Intercept Point (IIP3).

Additionally, the balanced nature of the mixer provides for high port-to-port isolation.

LO Buffers and SPDT LO Switch

The LO buffers allow the input power of the SKY73023-11 to be in the range of ±3 dBm. The LO section is optimized for low-side LO injection. However, each of the two LOs can be driven over a wide frequency range with only slight degradation in performance.

A high isolation SPDT switch allows the SKY73023-11 to be used for frequency hopping applications. This switch provides greater than 45 dB of LO1 to LO2 isolation:

LO_SEL Input	LO Path Selected
High	LO1 (pin 19) enabled
Low	LO2 (pin 27) enabled

For applications that do not require frequency hopping, LO_SEL is fixed to one state and the appropriate LO input is used. An internal pull-down resistor enables the LO2 input.

IF Amplifier

The SKY73023-11 includes high dynamic range IF amplifiers that follow the passive mixers in the signal path. The outputs require a supply voltage connection using inductive chokes. These choke inductors should be high-Q and have the ability to handle 200 mA or greater.

A simple matching network allows the output ports to be matched to a balanced 200 Ω impedance. The IF amplifiers are optimized for IF frequencies between 40 and 300 MHz. The IF amplifiers can be operated outside of this range, but with a slight degradation in performance.

Electrical and Mechanical Specifications

The absolute maximum ratings of the SKY73023-11 are provided in Table 2 and the recommended operating conditions in Table 3. Electrical characteristics for the SKY73023-11 are provided in Table 4.

Typical performance characteristics of the SKY73023-11 are illustrated in Figures 3 through 34.

Table 2. SKY73023-11 Absolute Maximum Ratings

Parameter	Symbol	Minimum	Maximum	Units
Supply voltage, +5 V (VCC_RFA, VCC_RFB, VCC_IFA, VCC_IFB, VCC_LO)	VCC	4.5	5.5	V
Supply current	I _{CC}		440	mA
RF input power	P _{RF}		+20	dBm
LO input power	P _{LO}		+20	dBm
Operating case temperature	T _C	-40	+85	°C
Junction temperature	T _J		150	°C
Storage case temperature	T _{STG}	-40	+125	°C

Notes: Exposure to maximum rating conditions for extended periods may reduce device reliability. There is no damage to device with only one parameter set at the limit and all other parameters set at or below their nominal value.

Nominal thermal resistance (junction to center ground pad) is 5.1 °C/W.

Table 3. SKY73023-11 Recommended Operating Conditions

Parameter	Symbol	Minimum	Typical	Maximum	Units
Supply voltage, +5 V (VCC_RFA, VCC_RFB, VCC_IFA, VCC_IFB, VCC_LO)	VCC	4.75	5.00	5.25	V
Supply current	I _{CC}		375		mA
LO input power	P _{LO}	-6	0	+6	dBm
LO select input: high low	LO_SEL _H LO_SEL _L	2.2		0.8	V V
Operating case temperature	T _C	-40		+85	°C
RF frequency range	F _{RF}	1700		2200	MHz
LO frequency range (Note 1)	F _{LO}	1460		2000	MHz
IF frequency range	F _{IF}	40		300	MHz

Note 1: The SKY73023-11 has been optimized for low-side LO injection. However, the LO can be used outside of the specified frequency range with degraded performance.

Table 4. SKY73023-11 Electrical Specifications (1 of 2)

(Voltage Supply = +5 V, T_A = +25 °C, LO = 0 dBm, RF Frequency = 1880 MHz, IF Frequency = 201 MHz, LO Frequency = 1679 MHz, Unless Otherwise Noted)

Parameter	Symbol	Test Condition	Min	Typical	Max	Units
Conversion gain	G	F _{RF} = 1710 to 1980 MHz, P _{LO} = -3 to +3 dBm, VCC = 4.75 to 5.25 V	7.5	9.7		dB
Gain variation over temperature		T _A = -40 to +85 °C		±0.7		dB
Noise Figure	NF	F _{RF} = 1880 MHz		9.9		dB
Noise Figure variation over temperature		F _{RF} = 1880 MHz, T _A = -40 to +85 °C		±0.8		dB
Noise Figure with a blocker signal	NF _{BLK}	Blocking signal input power = +8 dBm		18		dB
Third order input intercept point	IIP3	F _{RF} = 1880 and 1880.8 MHz, P _{RF} = -10 dBm/each tone, P _{LO} = -3 to +3 dBm, VCC = 4.75 to 5.25 V	+23.8	+25.7		dBm
Third order input intercept point variation over temperature		F _{RF} = 1880 and 1880.8 MHz, T _A = -40 to +85 °C		±0.2		dB
Third order output intercept point	OIP3	F _{RF} = 1880 and 1880.8 MHz, P _{RF} = -10 dBm/each tone, P _{LO} = -3 to +3 dBm, VCC = 4.75 to 5.25 V		+35.4		dBm
2RF – 2LO	2x2	P _{RF} = -10 dBm		-73	-63	dBc
3RF – 3LO	3x3	P _{RF} = -10 dBm		-80		dBc
Input 1 dB compression point	IP1dB	F _{RF} = 1710 to 1980 MHz, P _{LO} = -3 to +3 dBm, VCC = 4.75 to 5.25 V	+12.0	+13.6		dBm
Output 1 dB compression point	OP1dB	F _{RF} = 1710 to 1980 MHz, P _{LO} = -3 to +3 dBm, VCC = 4.75 to 5.25 V		+22.3		dBm

Table 4. SKY73023-11 Electrical Specifications (2 of 2)

(Voltage Supply = +5 V, T_A = +25 °C, LO = 0 dBm, RF Frequency = 1880 MHz, IF Frequency = 201 MHz, LO Frequency = 1679 MHz, Unless Otherwise Noted)

Parameter	Symbol	Test Condition	Min	Typical	Max	Units
LO1-to-LO2 isolation				45		dB
Channel-to-channel isolation				52		dB
RF-to-IF-isolation			30	59		dB
LO leakage: @ RF port				-38	-20	dBm
@ IF port				-45	-23	dBm
LO_SEL input			-20	150	250	μA
LO switching time					0.5	μs
RF port input return loss	Z _{IN_RF}	With external matching components	14			dB
LO port input return loss	Z _{IN_LO}	With external matching components	14			dB
IF port input return loss	Z _{OUT_IF}	With external matching components	14			dB

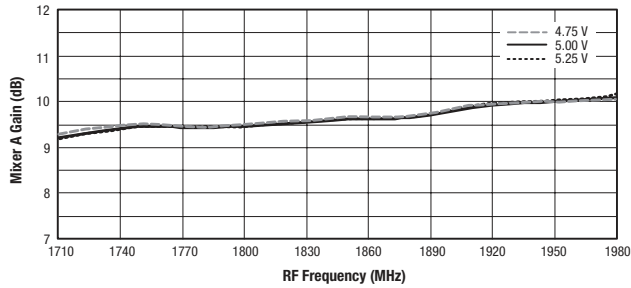

Figure 3. Mixer A Gain vs Frequency and Supply Voltage

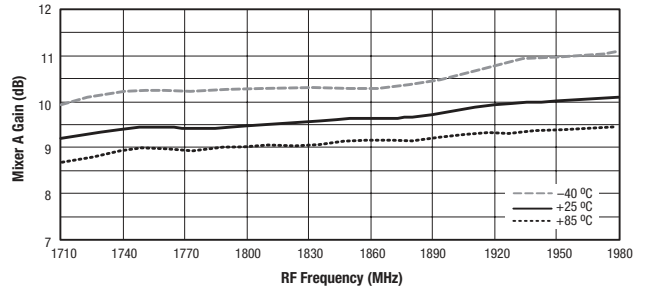

Figure 4. Mixer A Gain vs Frequency and Temperature

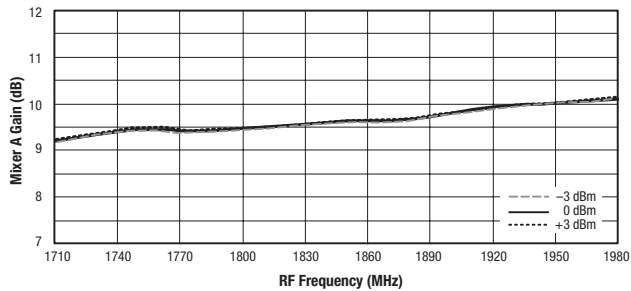

Figure 5. Mixer A Gain vs Frequency and LO Power

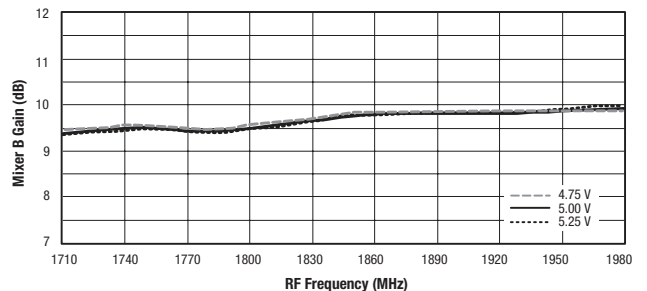

Figure 6. Mixer B Gain vs Frequency and Supply Voltage

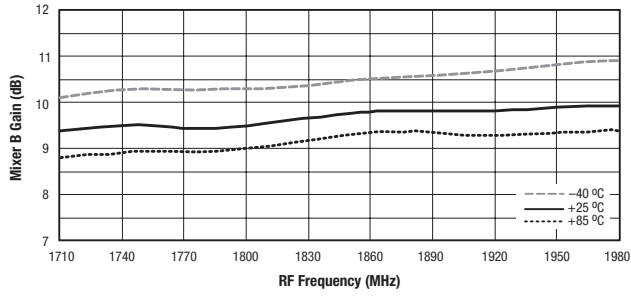

Figure 7. Mixer B Gain vs Frequency and Temperature

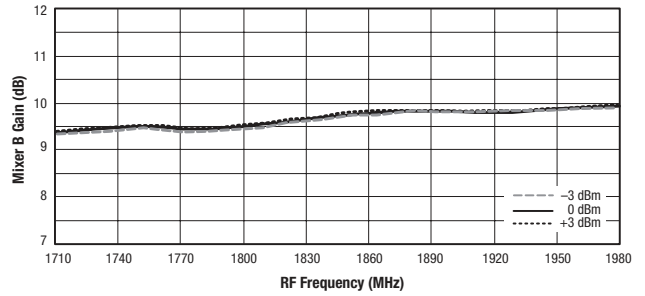

Figure 8. Mixer B Gain vs Frequency and LO Power

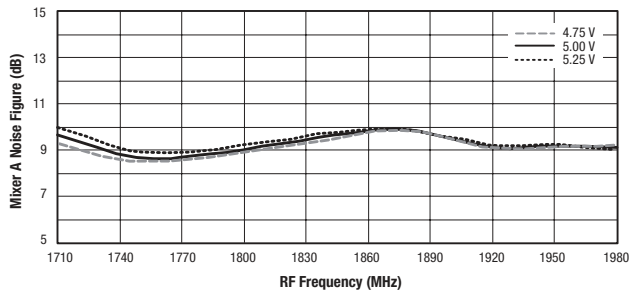

Figure 9. Mixer A Noise Figure vs Frequency and Supply Voltage

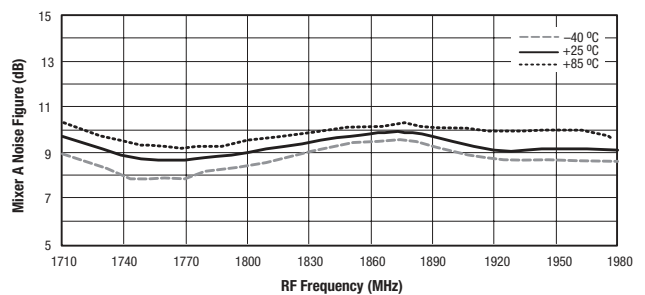

Figure 10. Mixer A Noise Figure vs Frequency and Temperature

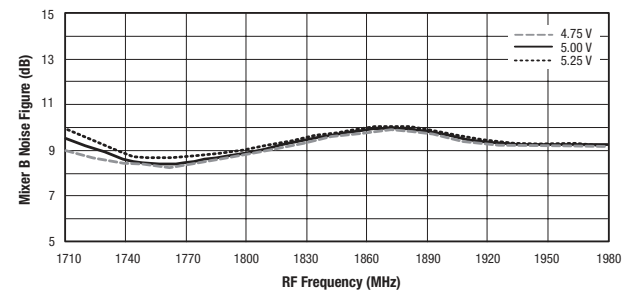

Figure 11. Mixer B Noise Figure vs Frequency and Supply Voltage

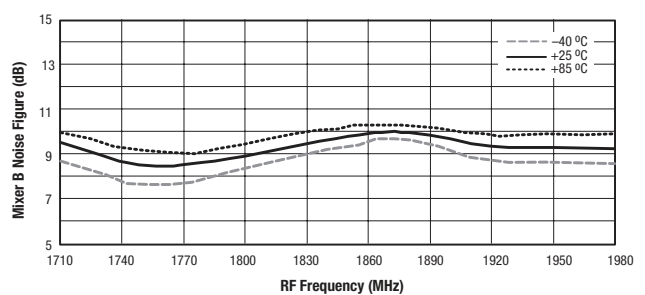

Figure 12. Mixer B Noise Figure vs Frequency and Temperature

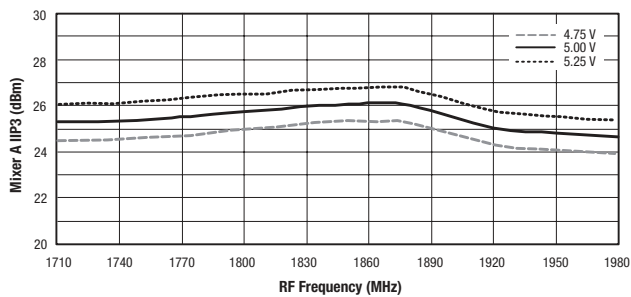

Figure 13. Mixer A IIP3 vs Frequency and Supply Voltage

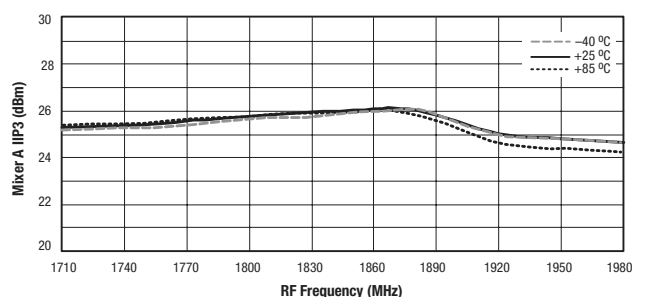

Figure 14. Mixer A IIP3 vs Frequency and Temperature

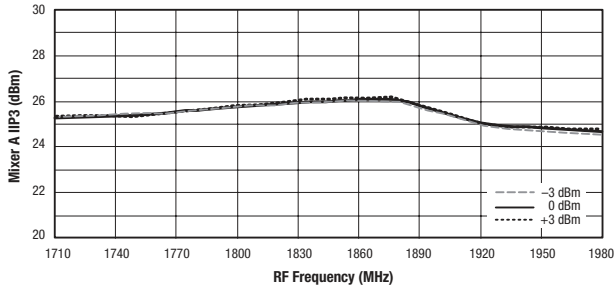

Figure 15. Mixer A IIP3 vs Frequency and LO Power

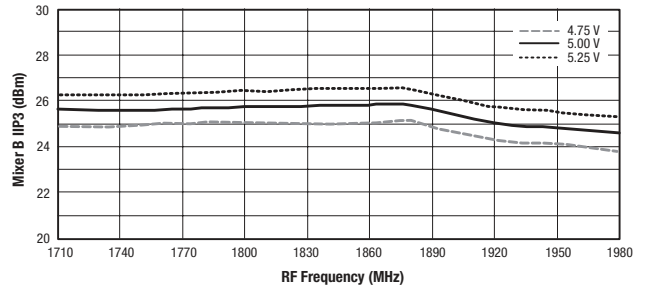

Figure 16. Mixer B IIP3 vs Frequency and Supply Voltage

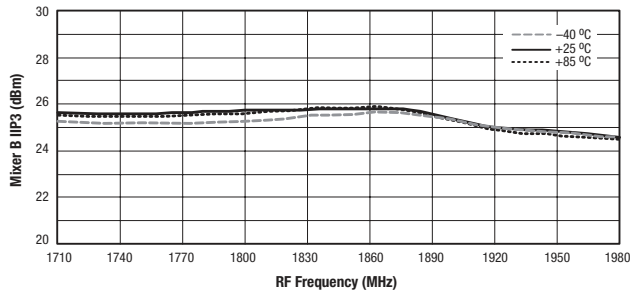

Figure 17. Mixer B IIP3 vs Frequency and Temperature

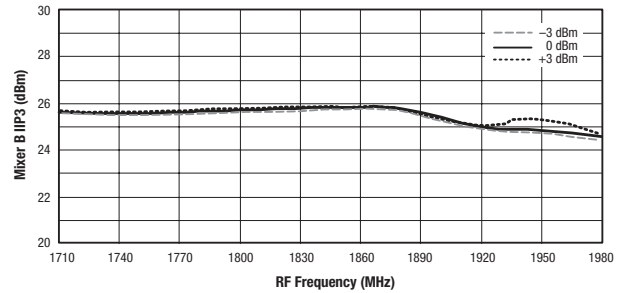

Figure 18. Mixer B IIP3 vs Frequency and LO Power

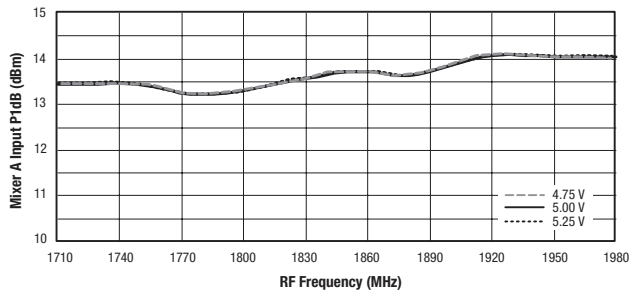

Figure 19. Mixer A Input P1dB vs Frequency and Supply Voltage

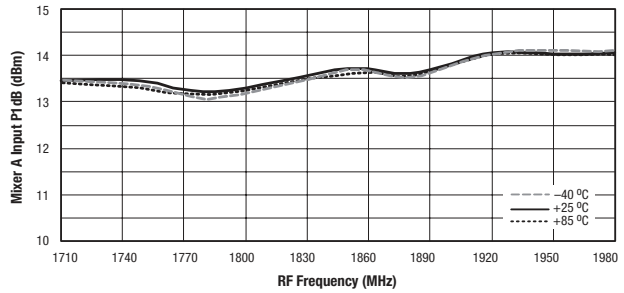

Figure 20. Mixer A Input P1dB vs Frequency and Temperature

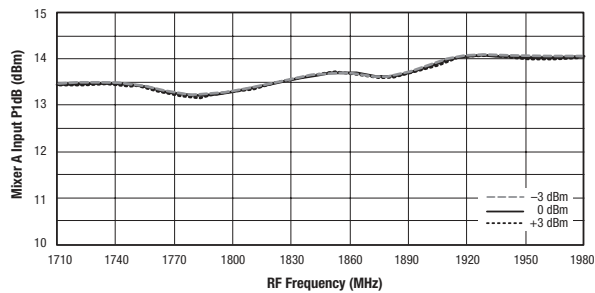

Figure 21. Mixer A Input P1dB vs Frequency and LP Power

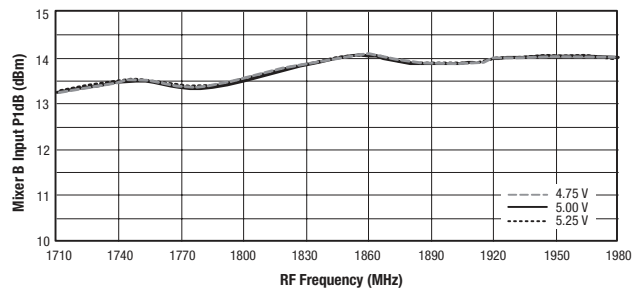

Figure 22. Mixer B Input P1dB vs Frequency and Supply Voltage

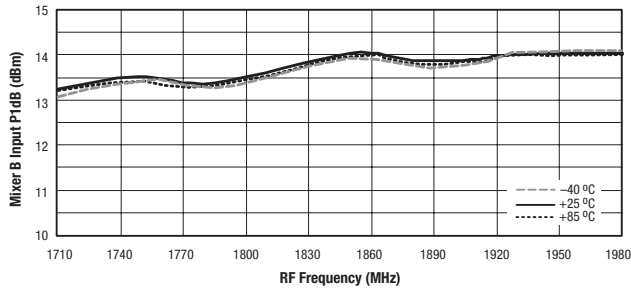

Figure 23. Mixer B Input P1dB vs Frequency and Temperature

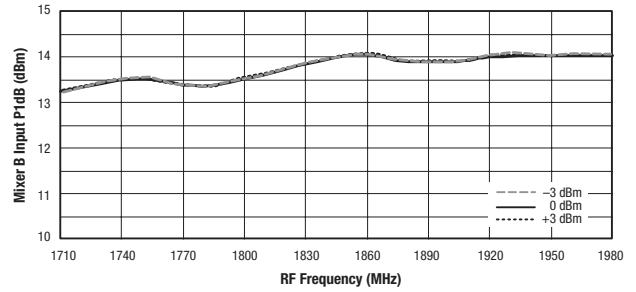

Figure 24. Mixer B Input P1dB vs Frequency and LO Power

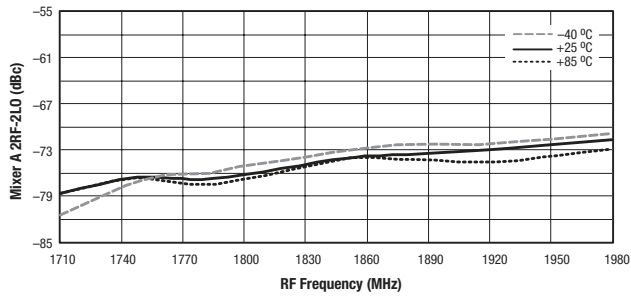

Figure 25. Mixer A 2RF-2LO vs Frequency and Temperature

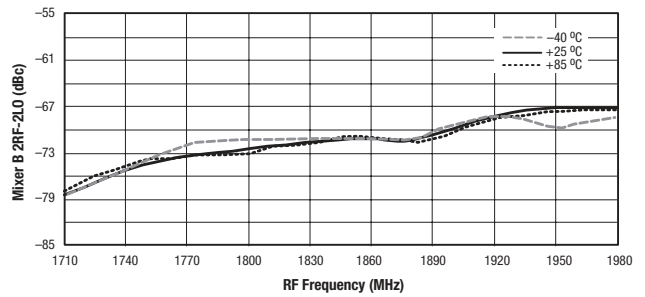

Figure 26. Mixer B 2RF-2LO vs Frequency and Temperature

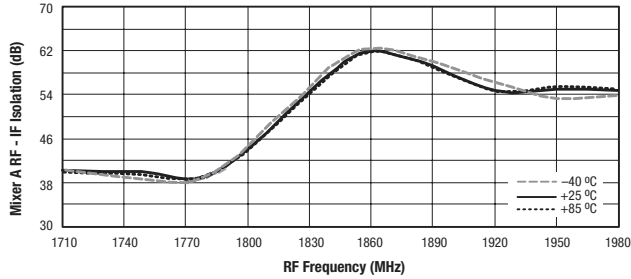

Figure 27. Mixer A RF to IF Isolation vs Frequency and Temperature

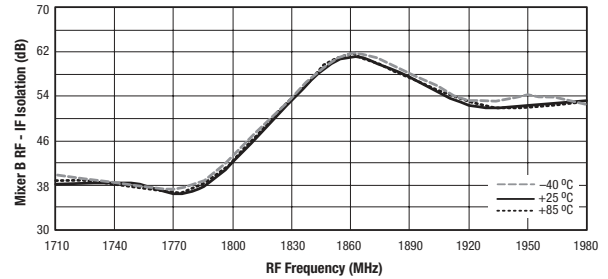

Figure 28. Mixer B RF to IF Isolation vs Frequency and Temperature

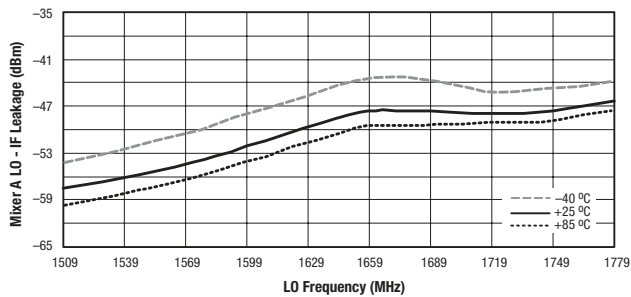

Figure 29. Mixer A LO to IF Leakage vs Frequency and Temperature

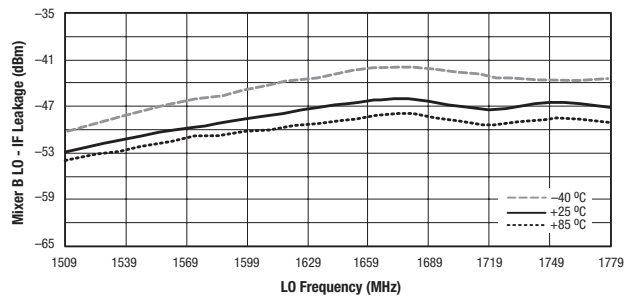

Figure 30. Mixer B LO to IF Leakage vs Frequency and Temperature

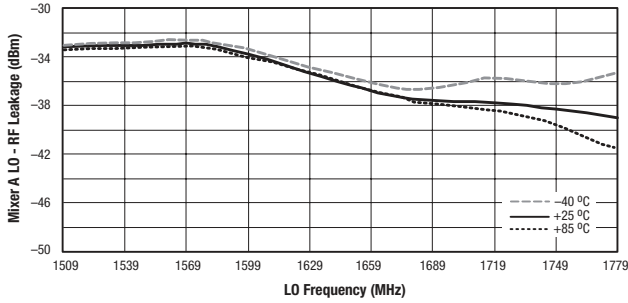

Figure 31. Mixer A LO to RF Leakage vs Frequency and Temperature

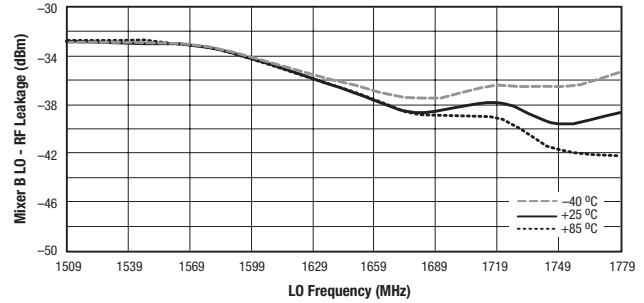

Figure 32. Mixer B LO to RF Leakage vs Frequency and Temperature

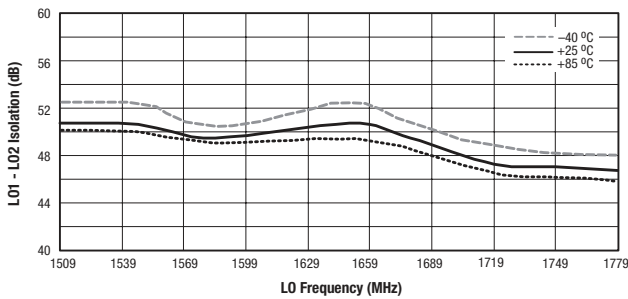

Figure 33. L01 to L02 Isolation vs Frequency and Supply Voltage

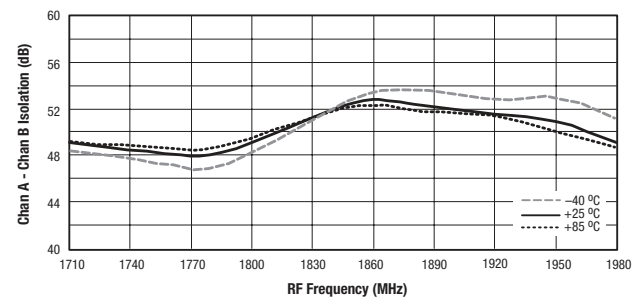

Figure 34. Channel A to Channel B IF Isolation vs Frequency and Supply Voltage

Evaluation Board Description

The SKY73023-11 Evaluation Board is used to test the performance of the SKY73023-11 downconversion mixer. An assembly drawing for the Evaluation Board is shown in Figure 35 and the layer detail is provided in Figure 36. A schematic diagram for the SKY73023-11 Evaluation Board is shown in Figure 37.

Circuit Design Configurations

The following design considerations are general in nature and must be followed regardless of final use or configuration:

1. Paths to ground should be made as short and as low impedance as possible.
2. The ground pad of the SKY73023-11 provides critical electrical and thermal functionality. This pad is the main thermal conduit for heat dissipation. Since the circuit board

acts as the heat sink, it must shunt as much heat as possible from the device. Therefore, design the connection to the ground pad to dissipate the maximum heat produced by the circuit board. For more information on soldering the SKY73023-11, refer to the Package and Handling Information section of this Data Sheet.

3. Skyworks recommends including external bypass capacitors on the VCC voltage inputs of the device.
4. Components L5, L6, L14, and L15 (see Figure 37) are high-Q, low loss inductors. These inductors must be able to pass currents in excess of 200 mA DC.
5. Components R1 and R2 (see Figure 37) allow for external adjustment of the IF amplifier bias points. For operation as specified in Tables 3 and 4, these resistors are not required.

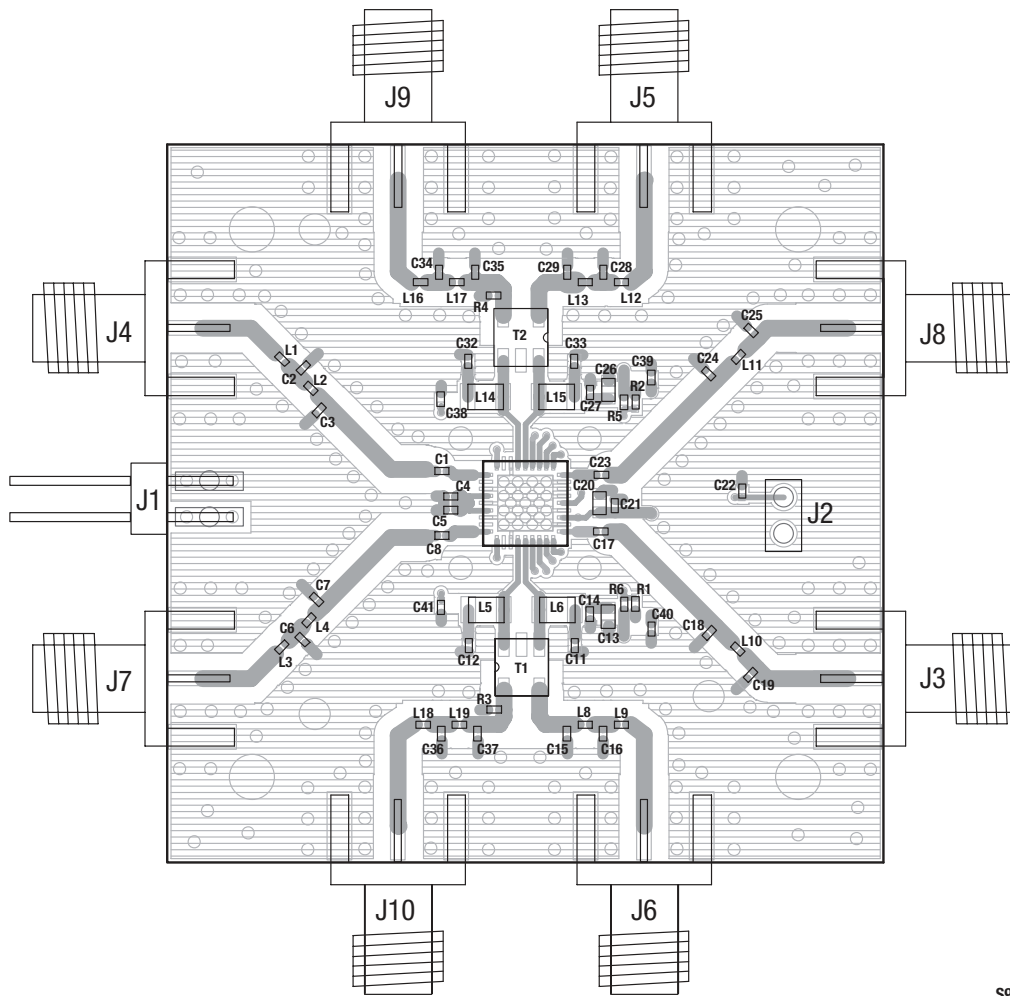

S905

Figure 35. SKY73023-11 Evaluation Board Assembly Diagram

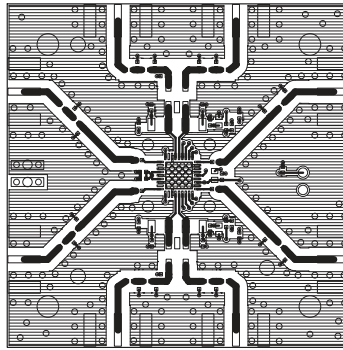

Layer 1: Top -- Metal

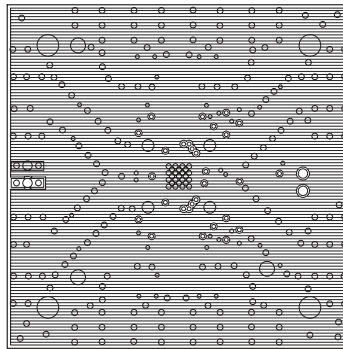

Layer 2: Ground

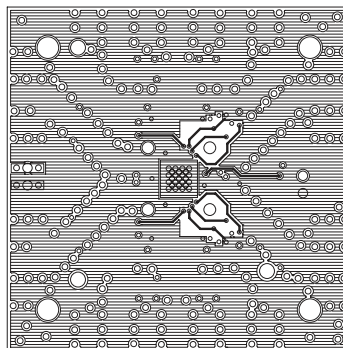

Layer 3: Power Plane

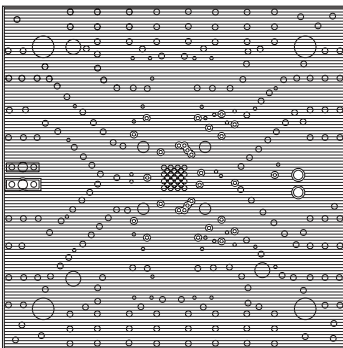

Layer 4: Solid Ground Plane

S904

Figure 36. SKY73023-11 Evaluation Board Layer Detail

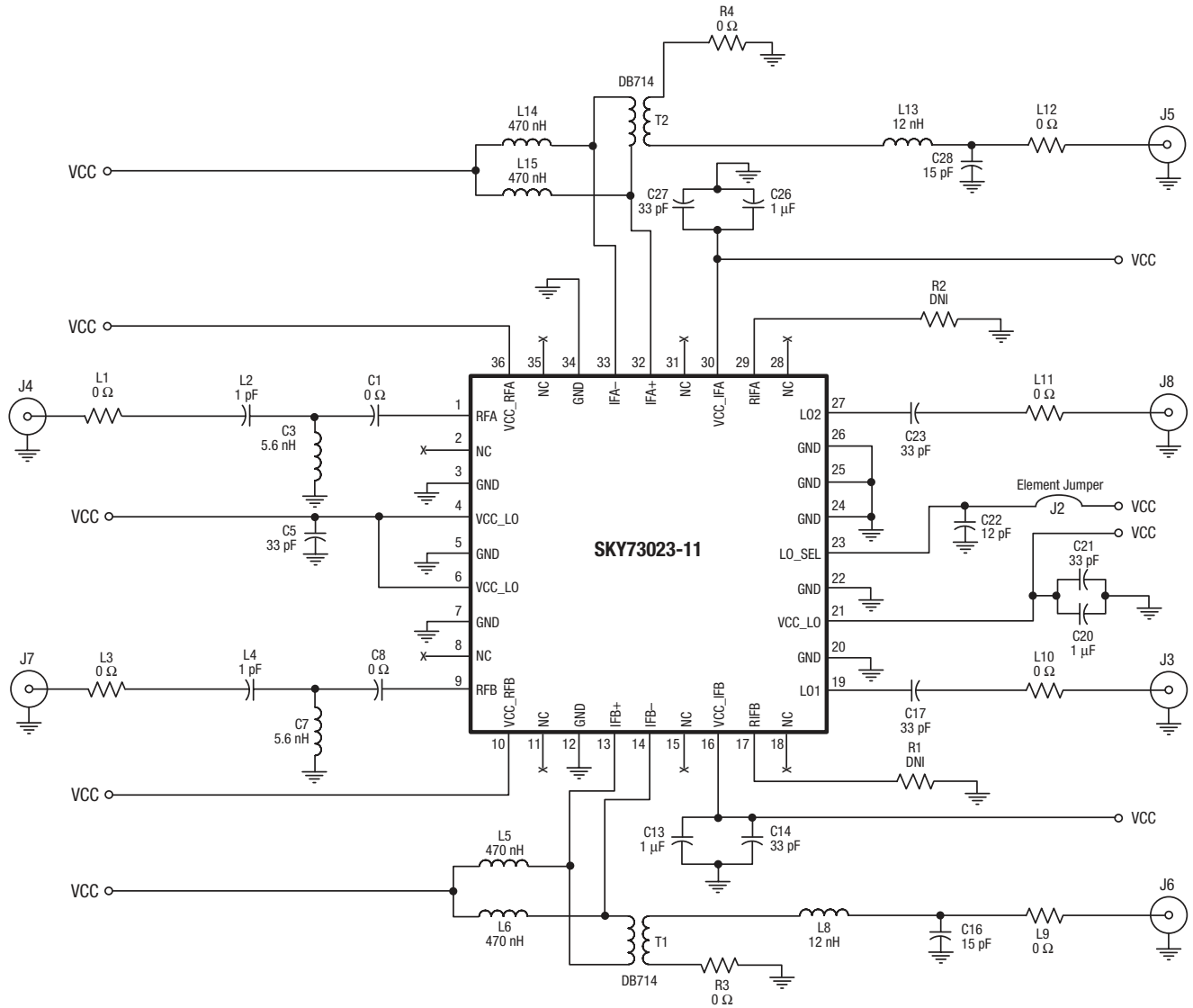

Note: The Evaluation Board can be converted to provide a differential output by removing components T1, T2, R3, and R4.

S947

Figure 37. SKY73023-11 Evaluation Board Schematic

Package Dimensions

The PCB layout footprint for the SKY73023-11 is provided in Figure 38. Figure 39 shows the package dimensions for the 36-pin MCM, and Figure 40 provides the tape and reel dimensions.

Package and Handling Information

Since the device package is sensitive to moisture absorption, it is baked and vacuum packed before shipping. Instructions on the shipping container label regarding exposure to moisture after the container seal is broken must be followed. Otherwise, problems related to moisture absorption may occur when the part is subjected to high temperature during solder assembly.

THE SKY73023-11 is rated to Moisture Sensitivity Level 3 (MSL3) at 260 °C. It can be used for lead or lead-free soldering. For

additional information, refer to the Skyworks Application Note, *PCB Design & SMT Assembly/Rework Guidelines for MCM-L Packages*, document number 101752.

Care must be taken when attaching this product, whether it is done manually or in a production solder reflow environment. Production quantities of this product are shipped in a standard tape and reel format. For packaging details, refer to the Skyworks Application Note, *Tape and Reel*, document number 101568.

Electrostatic Discharge (ESD) Sensitivity

The SKY73023-11 is a static-sensitive electronic device. Do not operate or store near strong electrostatic fields. Take proper ESD precautions.

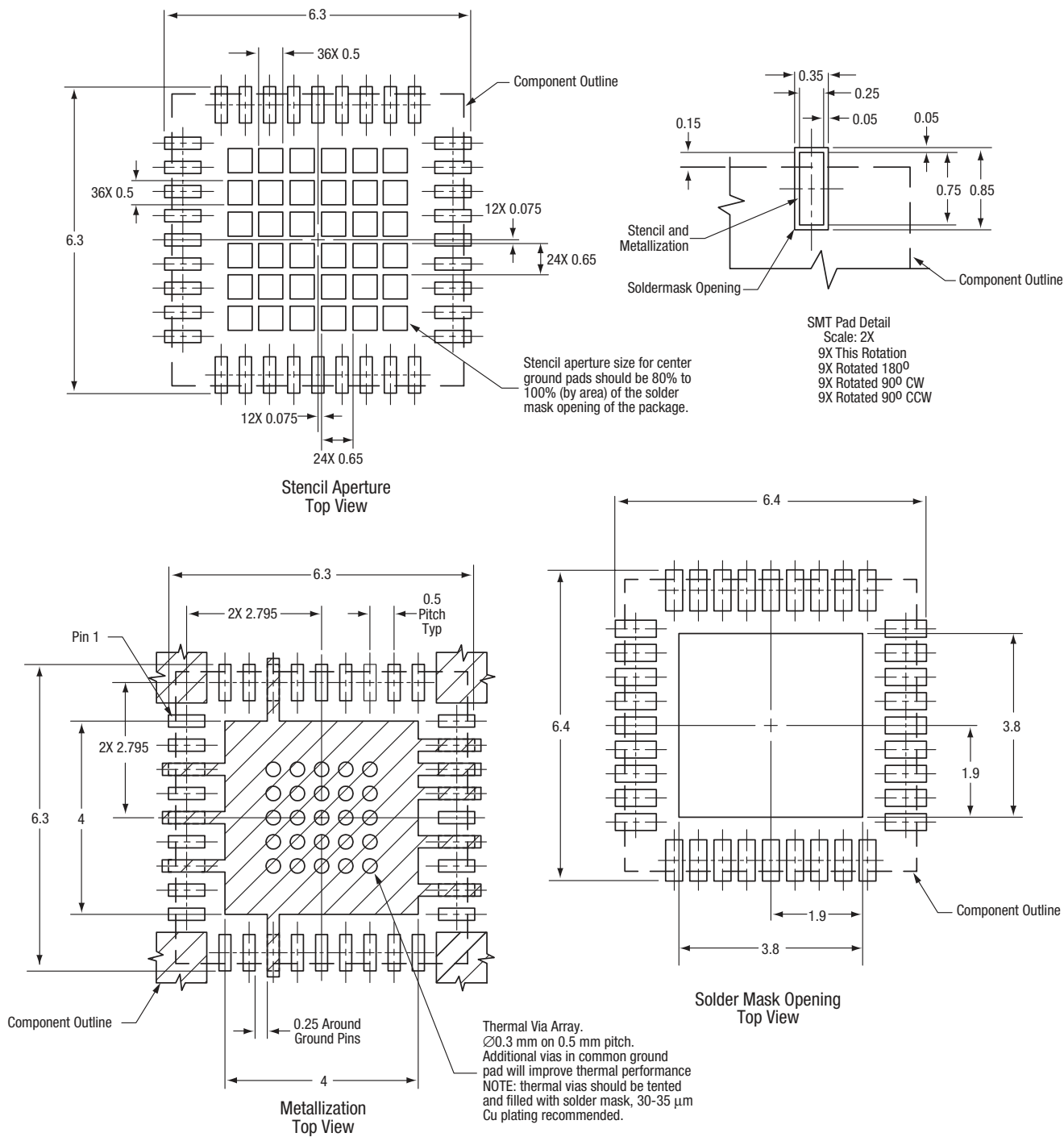

All measurements are in millimeters

S1125

Figure 38. PCB Layout Footprint for the SKY73023-11 6 x 6 MCM

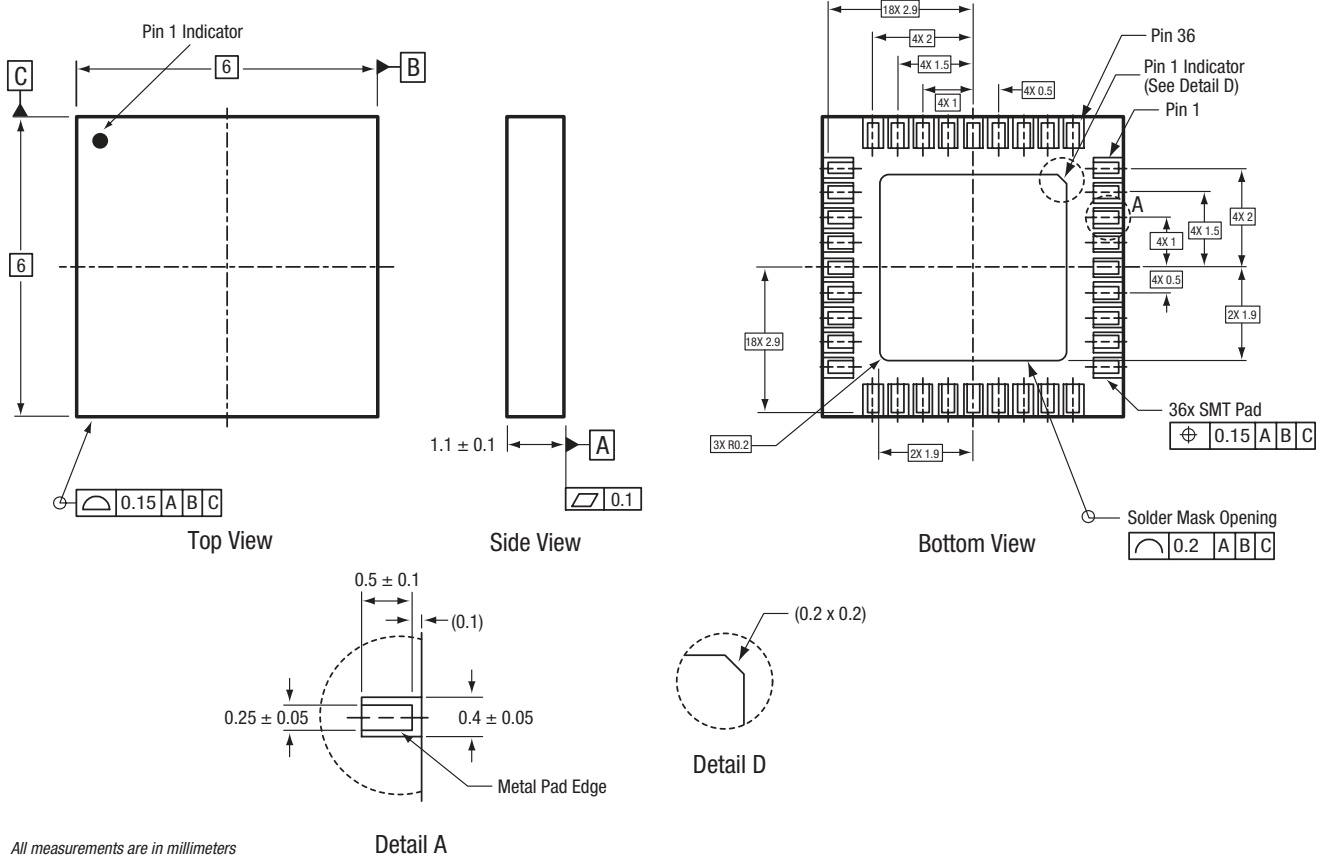

All measurements are in millimeters

Pads are solder mask defined on one edge and metal defined on three edges.

Dimensioning and tolerancing according to ASME Y14.5M-1994

S689_A

Figure 39. SKY73023-11 36-Pin MCM Package Dimensions

DATA SHEET • SKY73023-11 DOWNCONVERSION MIXER

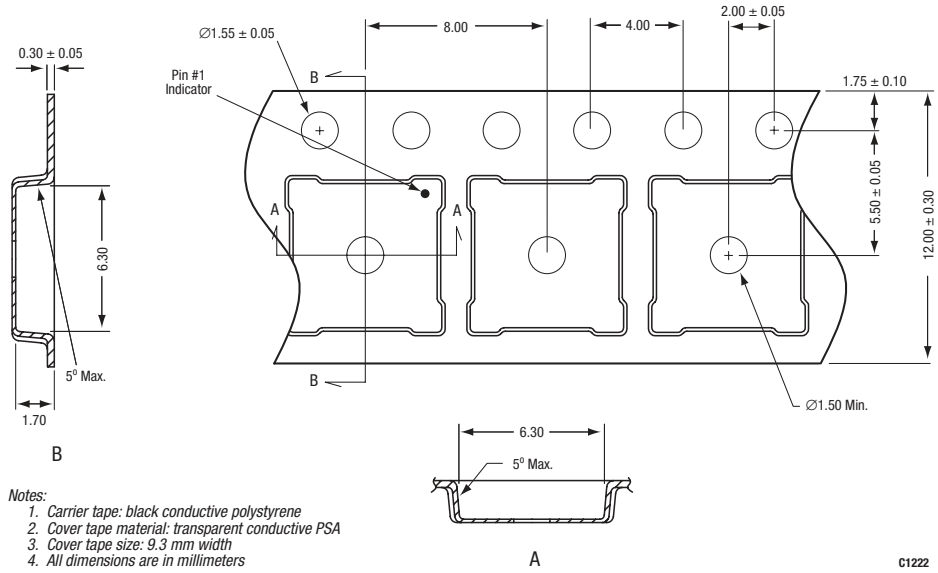

Figure 40. SKY73023-11 Tape and Reel Dimensions

Ordering Information

Model Name	Manufacturing Part Number	Evaluation Kit Part Number
SKY73023-11 Downconversion Mixer	SKY73023-11 (Pb-free package)	TW16-D730

Copyright © 2007, 2008 Skyworks Solutions, Inc. All Rights Reserved.

Information in this document is provided in connection with Skyworks Solutions, Inc. ("Skyworks") products or services. These materials, including the information contained herein, are provided by Skyworks as a service to its customers and may be used for informational purposes only by the customer. Skyworks assumes no responsibility for errors or omissions in these materials or the information contained herein. Skyworks may change its documentation, products, services, specifications or product descriptions at any time, without notice. Skyworks makes no commitment to update the materials or information and shall have no responsibility whatsoever for conflicts, incompatibilities, or other difficulties arising from any future changes.

No license, whether express, implied, by estoppel or otherwise, is granted to any intellectual property rights by this document. Skyworks assumes no liability for any materials, products or information provided hereunder, including the sale, distribution, reproduction or use of Skyworks products, information or materials, except as may be provided in Skyworks Terms and Conditions of Sale.

THE MATERIALS, PRODUCTS AND INFORMATION ARE PROVIDED "AS IS" WITHOUT WARRANTY OF ANY KIND, WHETHER EXPRESS, IMPLIED, STATUTORY, OR OTHERWISE, INCLUDING FITNESS FOR A PARTICULAR PURPOSE OR USE, MERCHANTABILITY, PERFORMANCE, QUALITY OR NON-INFRINGEMENT OF ANY INTELLECTUAL PROPERTY RIGHT; ALL SUCH WARRANTIES ARE HEREBY EXPRESSLY DISCLAIMED. SKYWORKS DOES NOT WARRANT THE ACCURACY OR COMPLETENESS OF THE INFORMATION, TEXT, GRAPHICS OR OTHER ITEMS CONTAINED WITHIN THESE MATERIALS. SKYWORKS SHALL NOT BE LIABLE FOR ANY DAMAGES, INCLUDING BUT NOT LIMITED TO ANY SPECIAL, INDIRECT, INCIDENTAL, STATUTORY, OR CONSEQUENTIAL DAMAGES, INCLUDING WITHOUT LIMITATION, LOST REVENUES OR LOST PROFITS THAT MAY RESULT FROM THE USE OF THE MATERIALS OR INFORMATION, WHETHER OR NOT THE RECIPIENT OF MATERIALS HAS BEEN ADVISED OF THE POSSIBILITY OF SUCH DAMAGE.

Skyworks products are not intended for use in medical, lifesaving or life-sustaining applications, or other equipment in which the failure of the Skyworks products could lead to personal injury, death, physical or environmental damage. Skyworks customers using or selling Skyworks products for use in such applications do so at their own risk and agree to fully indemnify Skyworks for any damages resulting from such improper use or sale.

Customers are responsible for their products and applications using Skyworks products, which may deviate from published specifications as a result of design defects, errors, or operation of products outside of published parameters or design specifications. Customers should include design and operating safeguards to minimize these and other risks. Skyworks assumes no liability for applications assistance, customer product design, or damage to any equipment resulting from the use of Skyworks products outside of stated published specifications or parameters.

Skyworks, the Skyworks symbol, and "Breakthrough Simplicity" are trademarks or registered trademarks of Skyworks Solutions, Inc., in the United States and other countries. Third-party brands and names are for identification purposes only, and are the property of their respective owners. Additional information, including relevant terms and conditions, posted at www.skyworksinc.com, are incorporated by reference.