

Conductive Fabric Gasket FBR Series

Product Technical Datasheet



Description

JONES Fabric Gaskets consist of conductive fabric over foam, and have been designed to meet commercial EMI shielding applications requiring low closure force and minimal compression set. JONES Fabric Gaskets are ideally suited for commercial electronic enclosures.

Features

JONES offers conductive fabric gaskets in different conductive fabric material, such as Cu/Ni, Al foil or copper foil, and in different profiles, such as D-shape, Rectangular-shape, L-shape, Ω -Shape or customized shape.

- Low surface contact resistance
- Shielding effectiveness >90dB (from 20MHz to 1GHz)
- Low compression force requirements
- Highly flexible and conformable
- Pressure sensitive adhesive as well as rigid mounting mechanisms
- Multiple cross section choice
- High corrosion resistance
- RoHS compliant

Selection Guide



Ni/Cu fabric



D-shape



Rectangular-shape



L-shape



Ω -shape



Customized shape

Performance Index

Feature	Specification	Test Method
Conductive fabric	Ni/Cu	-
Surface Resistivity	<0.05 Ω/\square	ASTM F390
Compression Set	<20%	ASTM D3574
Tear Strength X/Y	15/11N	JIS L 1096
Operating Temp.	-40°C ~+85°C	-
Compression Range	30%~50%	-
Shielding Effectiveness	>90dB (20MHz~1GHz)	MIL-G-83528
Flame Rating	V1 or V0	UL-94

Dimensional Tolerance

Dimension (mm)	Thickness Tolerance	Width Tolerance	Length Tolerance
<1	0.2	0.2	-
1~5	0.3	0.3	0.5
5~10	0.5	0.5	0.5
10~100	1	1	1
100~1000	-	2	2
1000~2000	-	-	3
>2000	-	-	5

Shielding Effectiveness

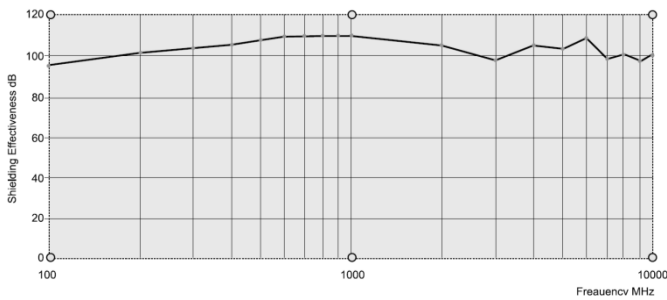

Force displacement Resistance

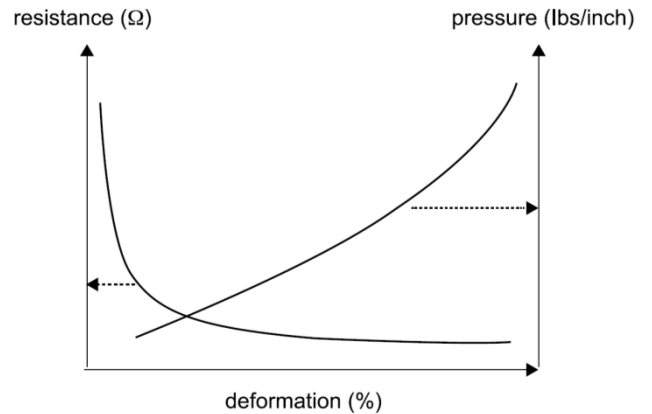

Compression-Deflection

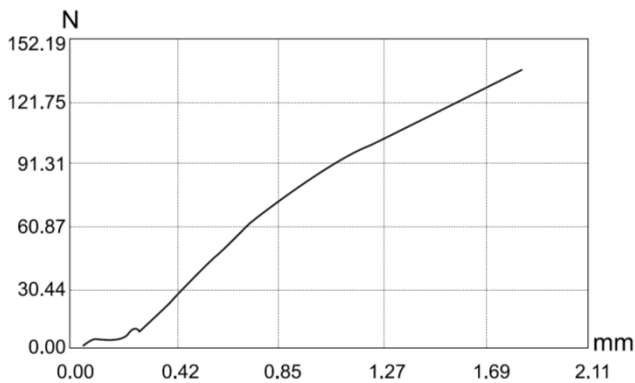

Order Information

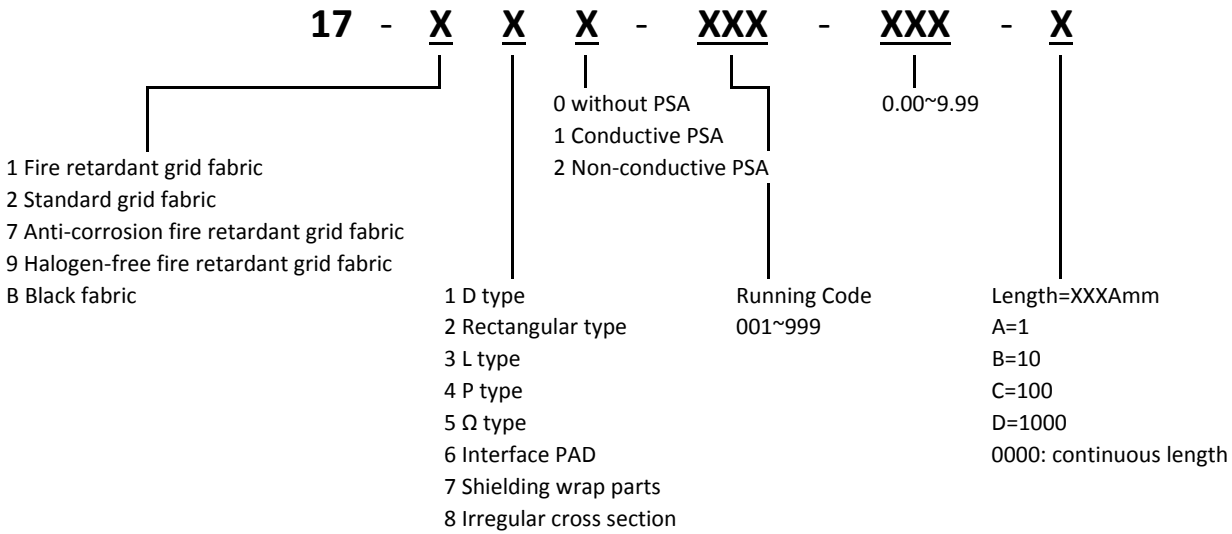

D-shape conductive fabric gasket

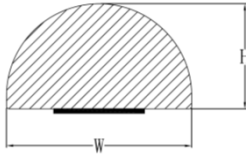

Part Number	Dimension (mm)	
	Width	Hight
17-X1X-017-0000	2.00	1.00
17-X1X-001-0000	2.20	2.20
17-X1X-024-0000	2.50	1.50
17-X1X-002-0000	2.50	3.00
17-X1X-003-0000	3.50	1.50
17-X1X-004-0000	3.80	1.50
17-X1X-021-0000	3.80	2.30
17-X1X-022-0000	3.80	3.00
17-X1X-025-0000	4.00	2.00
17-X1X-005-0000	4.00	3.00
17-X1X-006-0000	5.00	6.00
17-X1X-007-0000	6.00	3.00
17-X1X-008-0000	6.00	7.00
17-X1X-023-0000	6.30	2.50
17-X1X-009-0000	6.40	3.50
17-X1X-019-0000	7.60	4.80
17-X1X-011-0000	8.00	4.50
17-X1X-010-0000	8.00	5.00
17-X1X-012-0000	9.00	3.00
17-X1X-013-0000	9.50	6.40
17-X1X-020-0000	10.00	2.50
17-X1X-016-0000	12.70	9.50
17-X1X-015-0000	12.70	12.70

Rectangular conductive fabric gasket

Table 1

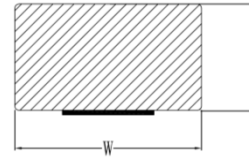

Part Number	Dimension (mm)	
	Width	Hight
17-X2X-001-0000	2.00	1.50
17-X2X-050-0000	2.00	2.00
17-X2X-076-0000	2.50	2.00
17-X2X-075-0000	3.00	0.50
17-X2X-055-0000	3.00	1.00
17-X2X-074-0000	3.00	1.50
17-X2X-002-0000	3.00	2.00
17-X2X-003-0000	3.00	3.00
17-X2X-004-0000	3.20	1.50
17-X2X-005-0000	3.50	3.50
17-X2X-048-0000	3.50	4.50
17-X2X-073-0000	4.00	0.60
17-X2X-006-0000	4.00	1.00
17-X2X-007-0000	4.00	2.00
17-X2X-046-0000	4.00	3.00
17-X2X-052-0000	4.00	4.00
17-X2X-062-0000	5.00	0.30
17-X2X-044-0000	5.00	0.50
17-X2X-008-0000	5.00	1.00
17-X2X-045-0000	5.00	2.00
17-X2X-009-0000	5.00	3.00
17-X2X-010-0000	5.00	4.00
17-X2X-011-0000	5.00	5.00

Rectangular conductive fabric gasket

Table 2

Part Number	Dimension (mm)	
	Width	Hight
17-X2X-070-0000	6.00	1.00
17-X2X-012-0000	6.00	1.50
17-X2X-013-0000	6.00	3.00
17-X2X-014-0000	6.00	6.00
17-X2X-058-0000	6.35	3.18
17-X2X-054-0000	6.35	12.70
17-X2X-063-0000	7.00	2.00
17-X2X-015-0000	7.00	7.00
17-X2X-056-0000	8.00	1.00
17-X2X-061-0000	8.00	2.00
17-X2X-051-0000	8.00	3.00
17-X2X-016-0000	8.00	4.00
17-X2X-017-0000	8.00	4.50
17-X2X-018-0000	9.00	1.50
17-X2X-039-0000	9.00	3.00
17-X2X-019-0000	9.00	4.00
17-X2X-059-0000	9.00	7.00
17-X2X-049-0000	9.50	3.20
17-X2X-020-0000	9.50	3.50
17-X2X-021-0000	10.00	1.00
17-X2X-022-0000	10.00	2.00
17-X2X-023-0000	10.00	3.00
17-X2X-024-0000	10.00	4.00
17-X2X-047-0000	10.00	5.00
17-X2X-025-0000	10.00	5.50
17-X2X-041-0000	10.00	6.00
17-X2X-026-0000	10.00	6.50
17-X2X-027-0000	10.00	8.00
17-X2X-028-0000	10.00	8.50
17-X2X-042-0000	10.00	10.00

L-shape conductive fabric gasket

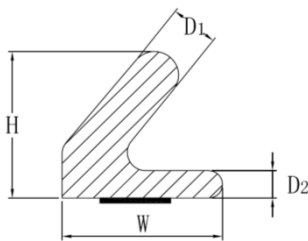

Part Number	Dimension (mm)			
	W	H	D1	D2
17-132-007-0000	10.7	9.8	3.0	2.0
17-132-001-0000	11.0	10.0	3.0	1.0
17-132-003-0000	14.7	17.2	3.9	3.7

Rectangular conductive fabric gasket

Tabel 3

Part Number	Dimension (mm)	
	Width	Hight
17-X2X-066-0000	10.00	13.00
17-X2X-040-0000	10.00	25.00
17-X2X-057-0000	11.00	1.00
17-X2X-064-0000	11.30	1.00
17-X2X-029-0000	12.00	3.50
17-X2X-043-0000	12.00	12.00
17-X2X-030-0000	12.70	6.40
17-X2X-031-0000	12.70	9.50
17-X2X-032-0000	13.00	3.00
17-X2X-053-0000	13.00	5.50
17-X2X-065-0000	13.00	10.00
17-X2X-067-0000	14.00	8.00
17-X2X-033-0000	15.00	2.00
17-X2X-034-0000	15.00	5.00
17-X2X-035-0000	17.00	7.00
17-X2X-036-0000	20.00	1.00
17-X2X-037-0000	20.00	15.00
17-X2X-072-0000	20.00	25.00
17-X2X-068-0000	21.00	4.00
17-X2X-038-0000	25.00	20.00
17-X2X-069-0000	30.00	30.00
17-X2X-071-0000	50.80	2.70

Ω-shape conductive fabric gasket

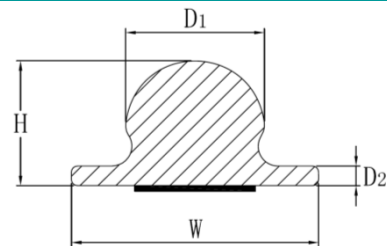

Part Number	Dimension (mm)				
	W	H	D1	D2	Note
17-X5X-001-0000	4.3	2.7	3.2	0.8	With PET
17-X5X-002-0000	6.0	3.0	3.0	0.6	With PET

Conductive interface gasket

Conductive interface gasket is made by die cutting of conductive fabric gasket or metal composite gasket. This type of product has features including high resilience and fire retardance for high anti-tearing performance, it can be bended repeatedly; it is one kind of shielding gasket products with the lowest cost.

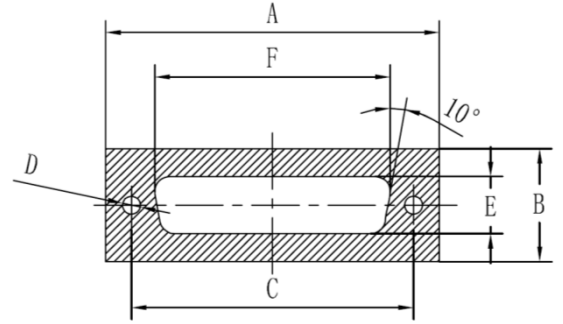

Part Number	Profile	Dimension (mm)					
		A	B	C	D	E	F
17-260-005-334B	9PIN	33.4	19.0	25.4	3.5	9.4	16.3
17-260-001-420B	15PIN	42.0	19.0	33.3	3.3	9.4	27.4
17-260-002-556B	25PIN	55.6	19.0	47.0	3.0	9.6	39.2
17-260-003-719B	37PIN	71.9	19.0	63.5	3.0	9.6	56.7
17-260-004-696B	50PIN	69.6	22.0	61.1	3.0	11.8	53.6