

AMY-45-S

~18° spot beam

SPECIFICATION:

Dimensions	Ø 45.0 mm
Height	10 mm
ROHS compliant	yes ⓘ

MATERIALS:

Component	Type	Material	Colour	Finish
AMY-45-S	Single lens	PMMA		

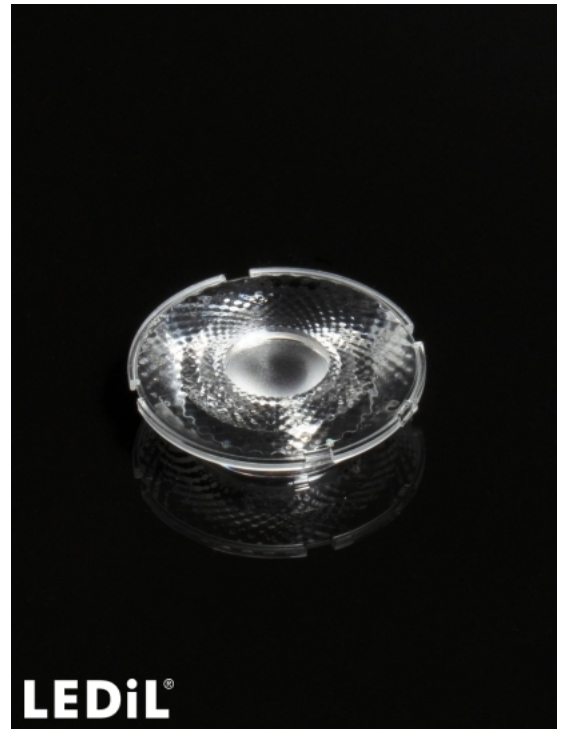





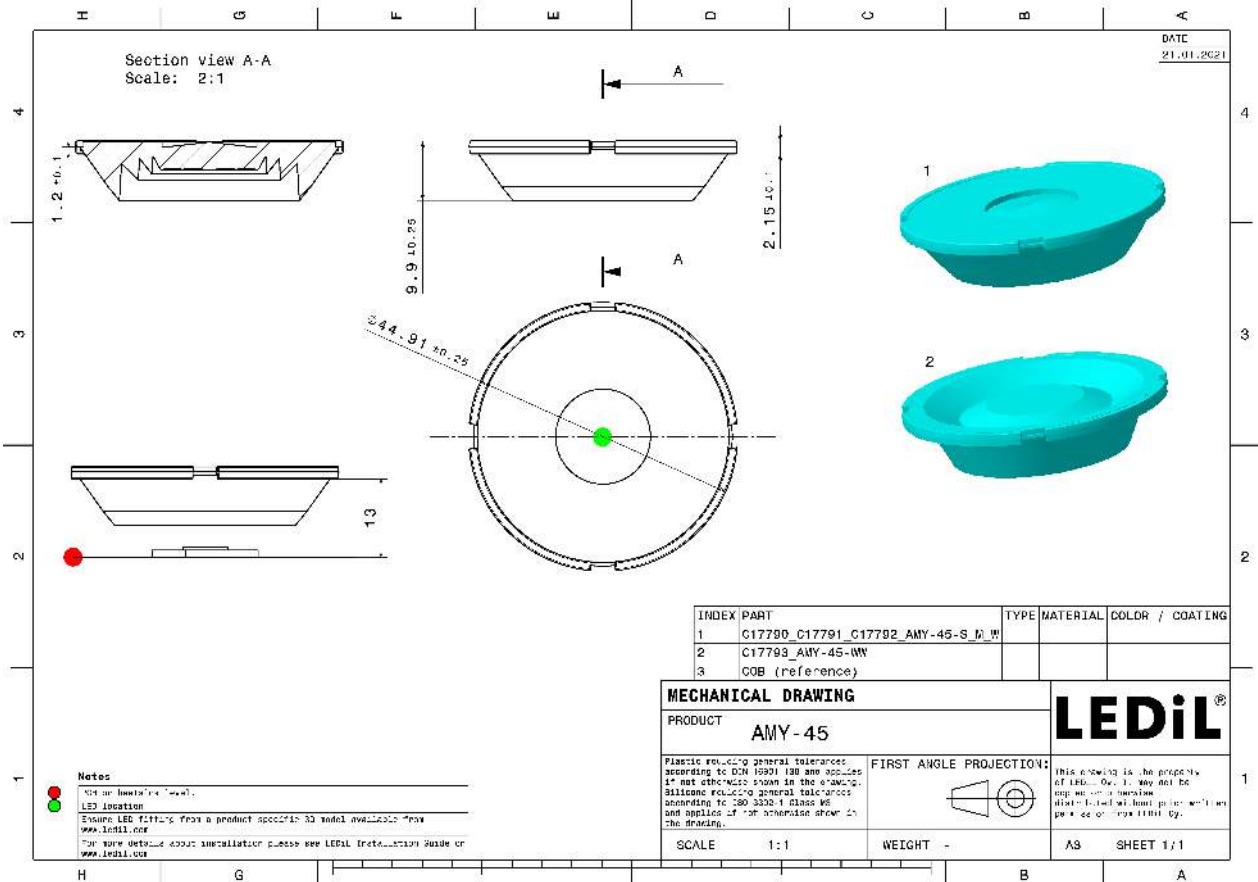

ORDERING INFORMATION:

Component	Qty in box	MOQ	MPQ	Box weight (kg)
C17790_AMY-45-S » Box size: 480 x 280 x 300 mm	690	120	30	7.7

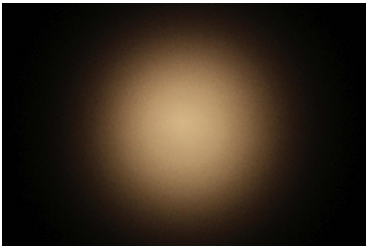
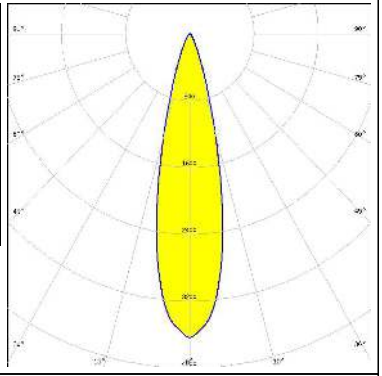

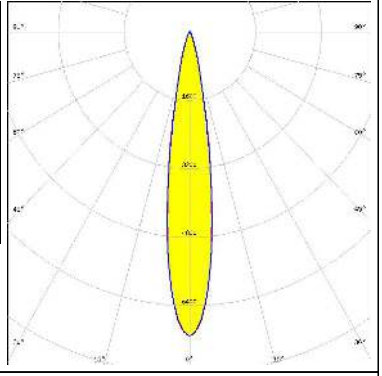
See also our general installation guide: www.ledil.com/installation_guide

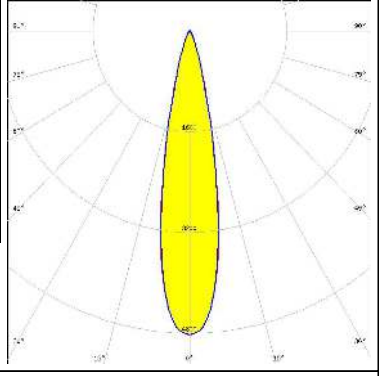
OPTICAL RESULTS (MEASURED):

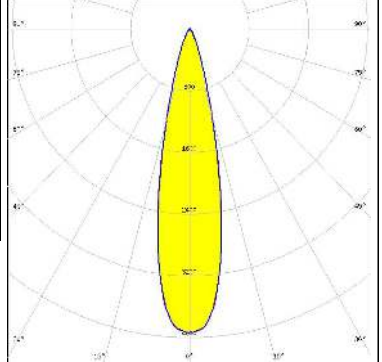
<p></p> <p>LED V11 HD Gen 8 FWHM / FWTM 25.0° / 46.0° Efficiency 87 % Peak intensity 3.7 cd/lm LEDs/each optic 1 Light colour White Required components: Bender Wirth: 633d Hekla</p>		
<p></p> <p>LED V6 HD Gen 7 FWHM / FWTM 17.0° / 32.0° Efficiency 89 % Peak intensity 7.1 cd/lm LEDs/each optic 1 Light colour White Required components: F15255_HEKLA-SOCKET-C</p>		
<p></p> <p>LED V9 HD Gen7 FWHM / FWTM 21.0° / 39.0° Efficiency 86 % Peak intensity 4.8 cd/lm LEDs/each optic 1 Light colour White Required components: F15859_HEKLA-SOCKET-I</p>		
<p>CITIZEN</p> <p>LED CLL02x/CLU02x (LES10) FWHM / FWTM 24.0° / 43.0° Efficiency 86 % Peak intensity 3.9 cd/lm LEDs/each optic 1 Light colour White Required components: F17435_HEKLA-G2-C</p>		

OPTICAL RESULTS (MEASURED):

CITIZEN

LED CLU700/701/702/703
 FWHM / FWTM 17.0° / 32.0°
 Efficiency 88 %
 Peak intensity 7.1 cd/m
 LEDs/each optic 1
 Light colour White
 Required components:
 F17435_HEKLA-G2-C

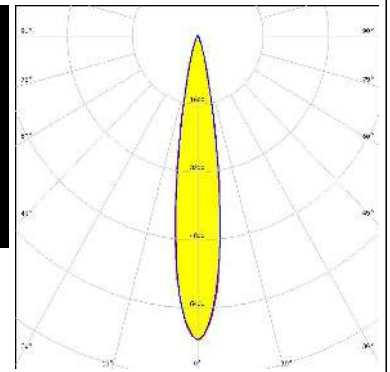

CREE LED

LED CMA1516
 FWHM / FWTM 23.0° / 42.0°
 Efficiency 85 %
 Peak intensity 4.2 cd/m
 LEDs/each optic 1
 Light colour White
 Required components:
 F17436_HEKLA-G2-D

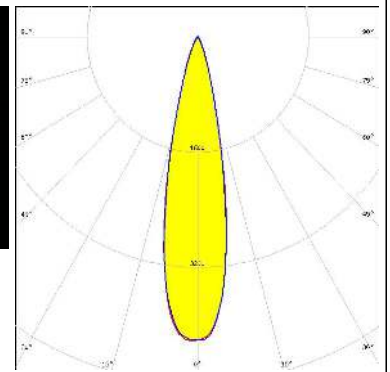
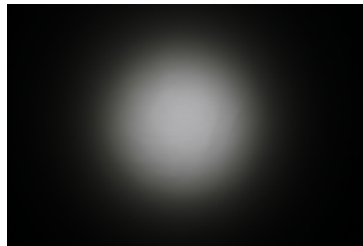

CREE LED

LED CMT14xx
 FWHM / FWTM 24.0° / 44.0°
 Efficiency 86 %
 Peak intensity 3.8 cd/m
 LEDs/each optic 1
 Light colour White
 Required components:
 F17435_HEKLA-G2-C

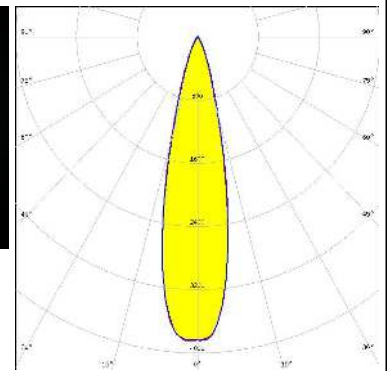
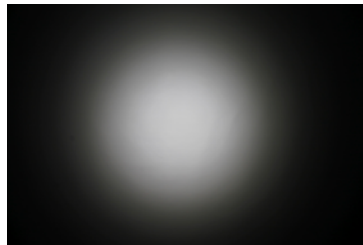





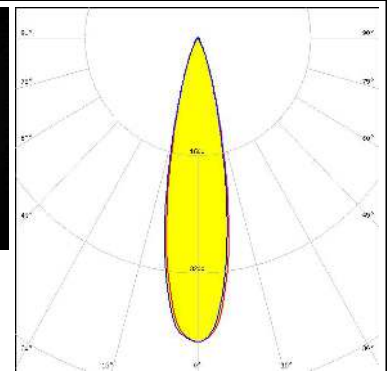

CREE LED

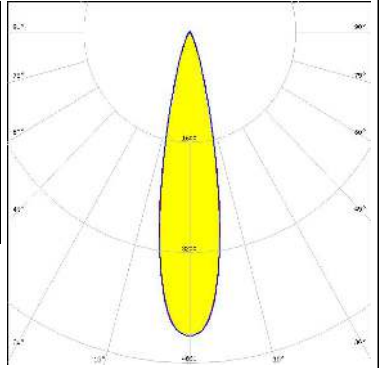

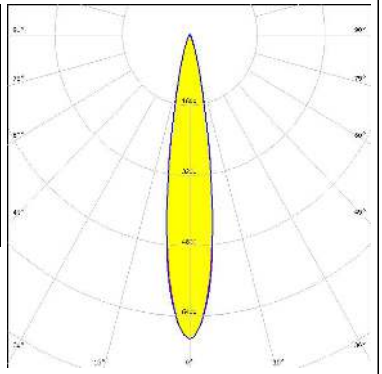

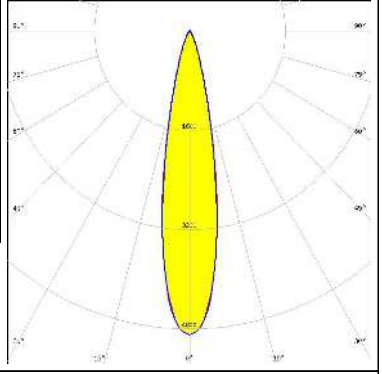

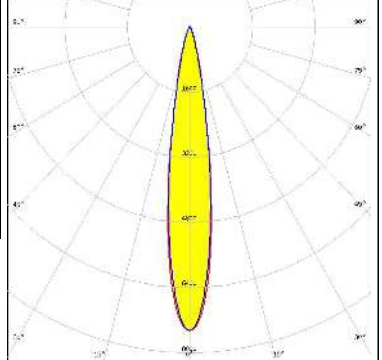
LED CMU10xx
 FWHM / FWTM 23.0° / 43.0°
 Efficiency 89 %
 Peak intensity 4.1 cd/m
 LEDs/each optic 1
 Light colour White
 Required components:
 BJB: 47.360.1020

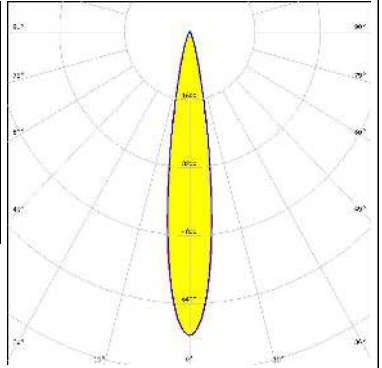

OPTICAL RESULTS (MEASURED):

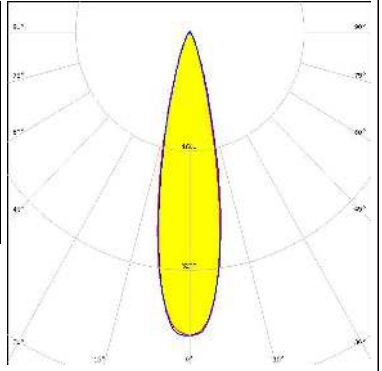
<p>LUMILEDS</p> <p>LED LUXEON CoB 1202/1203</p> <p>FWHM / FWTM 22.0° / 40.0°</p> <p>Efficiency 85 %</p> <p>Peak intensity 4.4 cd/m</p> <p>LEDs/each optic 1</p> <p>Light colour White</p> <p>Required components: F17437_HEKLA-G2-H</p>		
<p>LUMILEDS</p> <p>LED LUXEON CoB 1202s</p> <p>FWHM / FWTM 17.0° / 33.0°</p> <p>Efficiency 89 %</p> <p>Peak intensity 6.9 cd/m</p> <p>LEDs/each optic 1</p> <p>Light colour White</p> <p>Required components: F15848_HEKLA-SOCKET-G</p>		
<p>LUMILEDS</p> <p>LED LUXEON CX Plus CoB M02 / M03 (Gen2)</p> <p>FWHM / FWTM 21.0° / 40.0°</p> <p>Efficiency 88 %</p> <p>Peak intensity 4.9 cd/m</p> <p>LEDs/each optic 1</p> <p>Light colour White</p> <p>Required components: F15256_HEKLA-SOCKET-D</p>		
<p>LUMILEDS</p> <p>LED LUXEON CX Plus CoB S01 (Gen2)</p> <p>FWHM / FWTM 16.0° / 32.0°</p> <p>Efficiency 90 %</p> <p>Peak intensity 7.5 cd/m</p> <p>LEDs/each optic 1</p> <p>Light colour White</p> <p>Required components: F15956_HEKLA-SOCKET-J</p>		

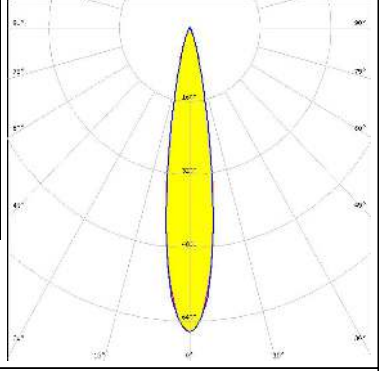
OPTICAL RESULTS (MEASURED):

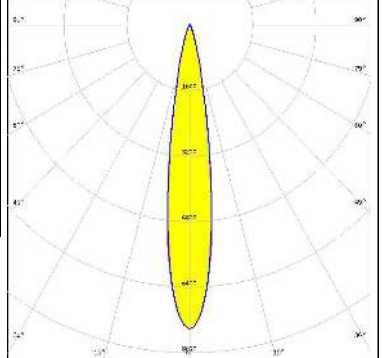
<p>LUMINUS</p> <p>LED CxM-6 (13.5x13.5) FWHM / FWTM 17.0° / 32.0° Efficiency 88 % Peak intensity 7.2 cd/m LEDs/each optic 1 Light colour White Required components: F17435_HEKLA-G2-C</p>		
<p>LUMINUS</p> <p>LED CxM-9 (13.5x13.5) FWHM / FWTM 23.0° / 43.0° Efficiency 86 % Peak intensity 4.1 cd/m LEDs/each optic 1 Light colour White Required components: F17435_HEKLA-G2-C</p>		
<p>NICHIA</p> <p>LED COB S-Type (LES 7) FWHM / FWTM 18.0° / 35.0° Efficiency 89 % Peak intensity 6.6 cd/m LEDs/each optic 1 Light colour White Required components: F15848_HEKLA-SOCKET-G</p>		
<p>NICHIA</p> <p>LED COB T-Type FWHM / FWTM 17.0° / 33.0° Efficiency 90 % Peak intensity 7.5 cd/m LEDs/each optic 1 Light colour White Required components: F15848_HEKLA-SOCKET-G</p>		

OPTICAL RESULTS (MEASURED):

SAMSUNG

LED LC003D / LC006D / LC009D / LC013D
 FWHM / FWTM 23.0° / 43.0°
 Efficiency 94 %
 Peak intensity 4.4 cd/lm
 LEDs/each optic 1
 Light colour White
 Required components:

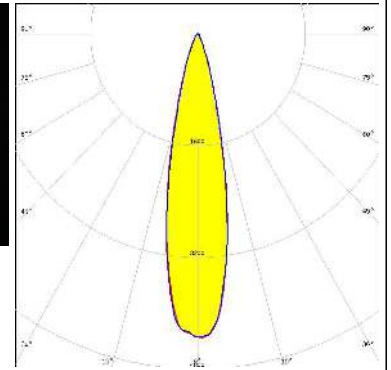

SEOUL SEMICONDUCTOR
 LED MJT COB LES 6
 FWHM / FWTM 16.0° / 31.0°
 Efficiency 88 %
 Peak intensity 7.7 cd/lm
 LEDs/each optic 1
 Light colour White
 Required components:
 F17435_HEKLA-G2-C

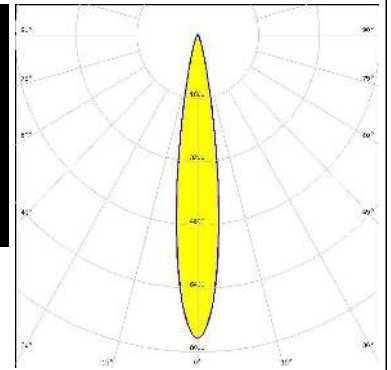
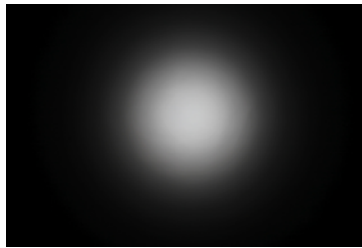

SEOUL SEMICONDUCTOR
 LED MJT COB LES 9.8
 FWHM / FWTM 24.0° / 44.0°
 Efficiency 86 %
 Peak intensity 4 cd/lm
 LEDs/each optic 1
 Light colour White
 Required components:
 F17435_HEKLA-G2-C

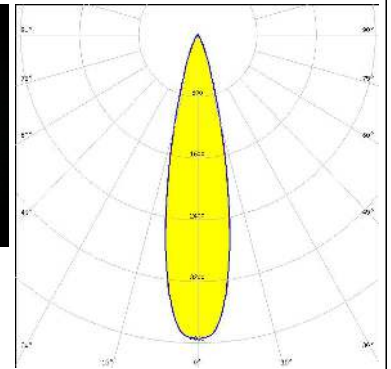
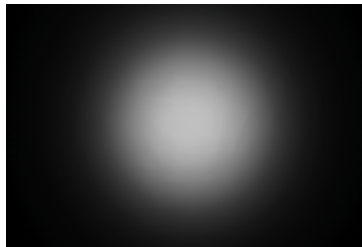

OPTICAL RESULTS (SIMULATED):

CITIZEN

LED CLU712/713
FWHM / FWTM 18.0° / 38.0°
Efficiency 92 %
Peak intensity 6.2 cd/lm
LEDs/each optic 1
Light colour White
Required components:
F17438_HEKLA-G2-I

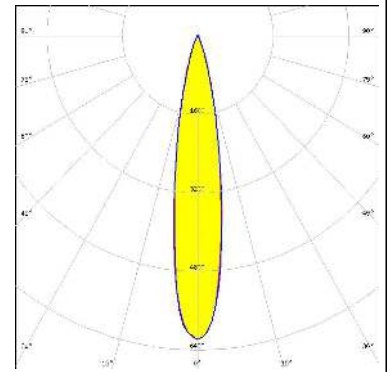

CREE LED

LED CMA1825
FWHM / FWTM 25.0° / 51.0°
Efficiency 89 %
Peak intensity 3.4 cd/lm
LEDs/each optic 1
Light colour White
Required components:
F15254_HEKLA-SOCKET-B

GENERAL INFORMATION:

NOTE: The typical beam angle will be changed by different color, chip size and chip position tolerance. The typical total beam angle is the full angle measured where the luminous intensity is half of the peak value.

Due to use of high power COB's with this product, special attention to proper thermal design is highly recommended. LEDiL has no liability for direct, indirect or consecutive damages arising from the LEDiL products being used outside of the recommended temperature range.

MATERIALS:

As part of our continuous research and improvement processes, and to ensure the best possible quality and availability of our products, LEDiL reserves the right to change material grades without notice.

PRODUCT DATA USER AGREEMENT AND DISCLAIMER:

The measured data in the provided downloadable LEDiL Product Datasheets and Mechanical 2D-Drawings is rounded and provided as reference for planning. LEDiL Oy's optical specifications have been verified by conducting performance testing of the products in accordance with the company's quality system. The reported data are averaged results of multiple measurements with typical variation. LEDiL Oy reserves the right to without prior notification make changes and improvements to its products.

LEDiL Oy assumes neither warranty, nor guarantee nor any other liability of any kind for the contents and correctness of the provided data. The provided data has been generated with highest diligence but the provided data may in reality not represent the complete possible variation range of all intrinsic parameters. Therefore, in certain cases a deviation from the provided data could occur.

LEDiL Oy reserves the right to undertake technical changes of its products without further notification which could lead to changes in the provided data. LEDiL Oy assumes no liability of any kind for the possible deviation from any provided data or any other damage resulting from the usage of the provided data.

The user agrees to this disclaimer and user agreement with the download or usage of the provided files.

LEDiL Oy

Joensuunkatu 13
FI-24240 SALO
Finland

LEDiL Inc.

228 West Page Street
Suite D
Sycamore IL 60178
USA

Ledil Optics Technology (Shenzhen) Co., Ltd.

405 , Block B
Casic Motor Building
Shenzhen 518057
P.R.CHINA

Local sales and technical support

[www.ledil.com/
where_to_buy](http://www.ledil.com/where_to_buy)

Shipping locations

Salo, Finland
Hong Kong, China

Distribution Partners

[www.ledil.com/
where_to_buy](http://www.ledil.com/where_to_buy)