

Inductors for decoupling circuits

Wound ferrite

ADL-V series (for automotive)



AEC-Q200

ADL3225V type



FEATURES

- Small size and thin form factor (mounting area 3.2 x 2.5 mm, height 2.5mm max.)
- Achieving broadband impedance characteristics and good DC superimposition characteristics as the result of an original coiled wiring design and original structure
- Ensuring consistent high quality and reliability as the result of a completely automated manufacturing process
- Operating temperature range: -40 to +105°C (including self-temperature rise)
- Compliant with AEC-Q200

APPLICATION

- Inductor for use with separate signal and power lines in in-vehicle PoC (Power Over Coax)

PART NUMBER CONSTRUCTION

ADL	3225	V	-	470	M	T	-	TL	000
Series name	LxWxH dimensions 3.2x2.5x2.3 mm	Characteristic type		Inductance (μH)	Inductance tolerance	Winding identification		Packaging style	Internal code

CHARACTERISTICS SPECIFICATION TABLE

L	L measuring frequency	DC resistance	Rated current*		Part No.
(μH)	Tolerance	(Ω)max.	Isat (mA)typ.	Itemp (mA)typ.	
47	±20%	100	300	500	ADL3225V-470MT-TL000

* Rated current: smaller value of either Isat or Itemp.

Isat: when based on the inductance change rate (30% below the nominal inductance value)

Itemp: When based on the temperature increase (temperature increase of 40°C by self heating)

Measurement equipment

Measurement item	Product No.	Manufacturer
Inductance	4294A	Keysight Technologies
DC resistance	4338A	Keysight Technologies

* Equivalent measurement equipment may be used.

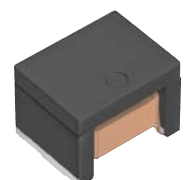

ADL3225V type

■ IMPEDANCE VS. FREQUENCY CHARACTERISTICS

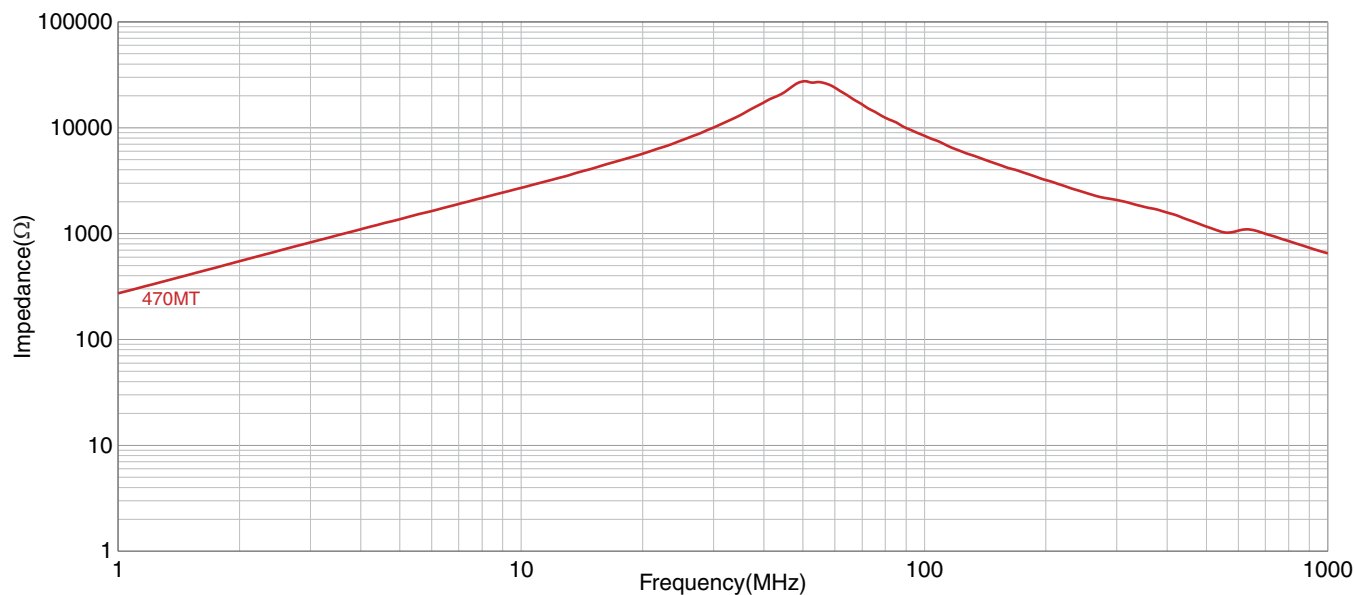

■ DERATING

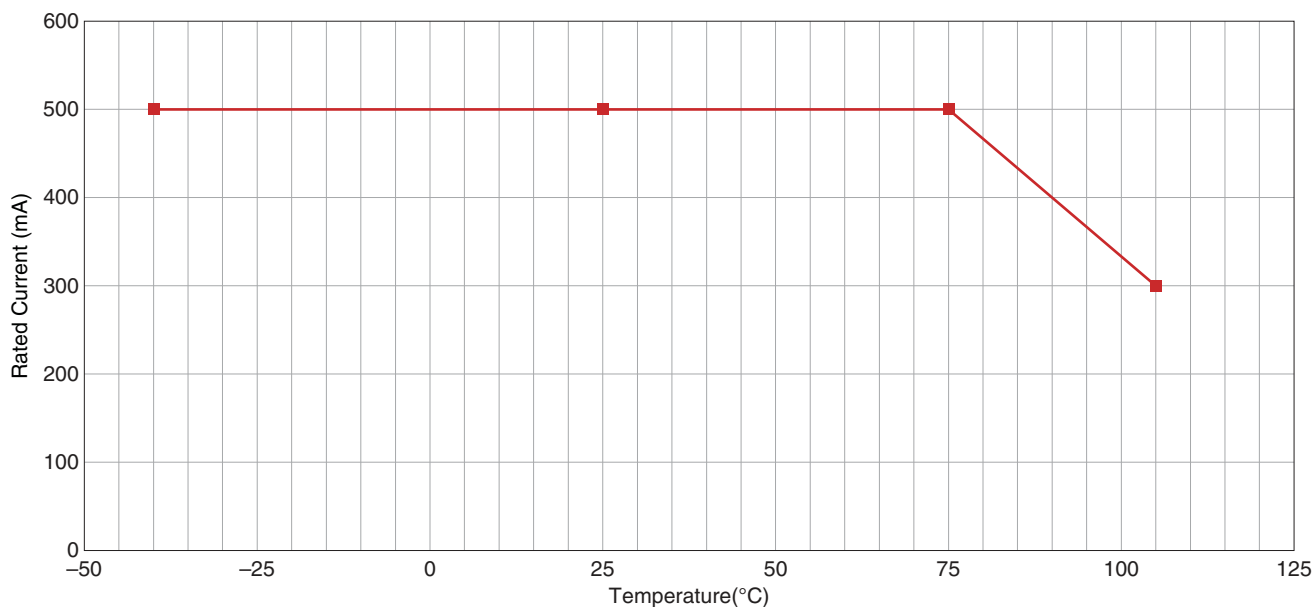

ADL3225V type

■ IMPEDANCE VS. DC BIAS CHARACTERISTICS

□ Unit of products

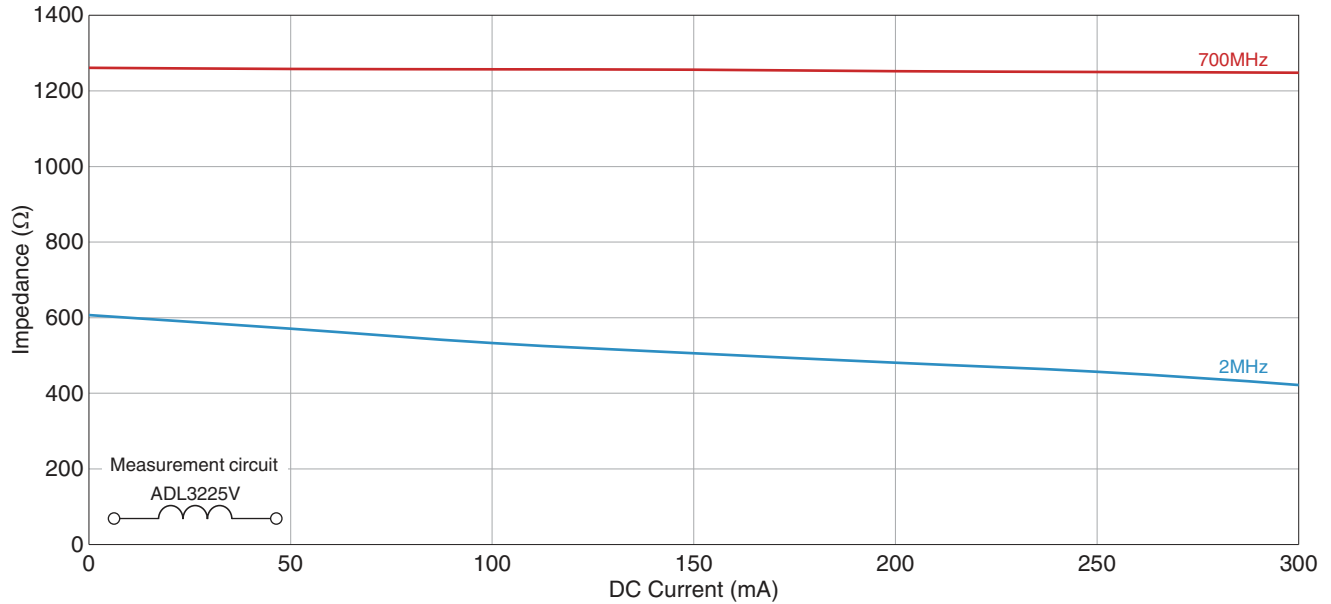

□ Recommended circuit

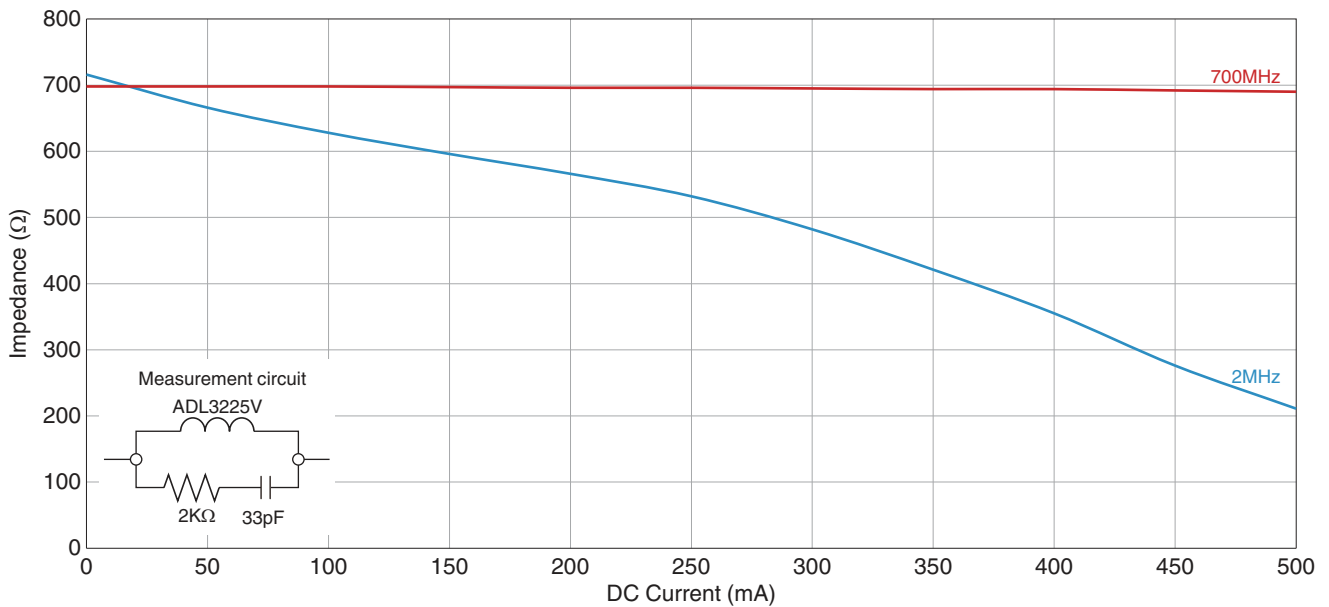

ADL3225V type

SHAPE & DIMENSIONS

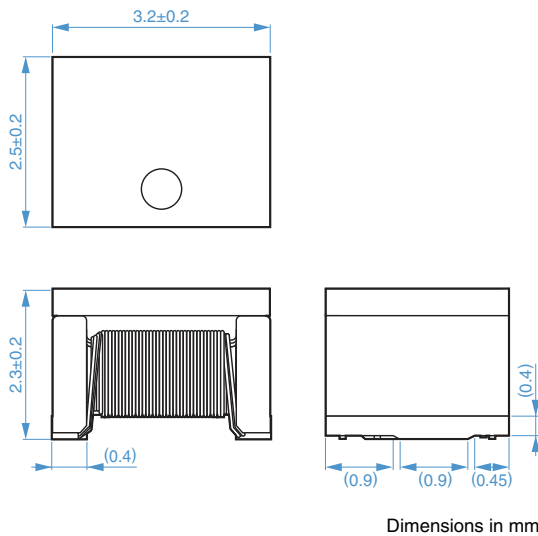

RECOMMENDED LAND PATTERN

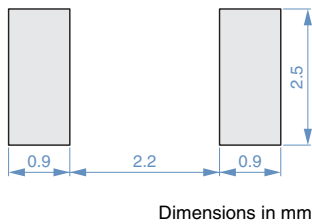

RECOMMENDED REFLOW PROFILE

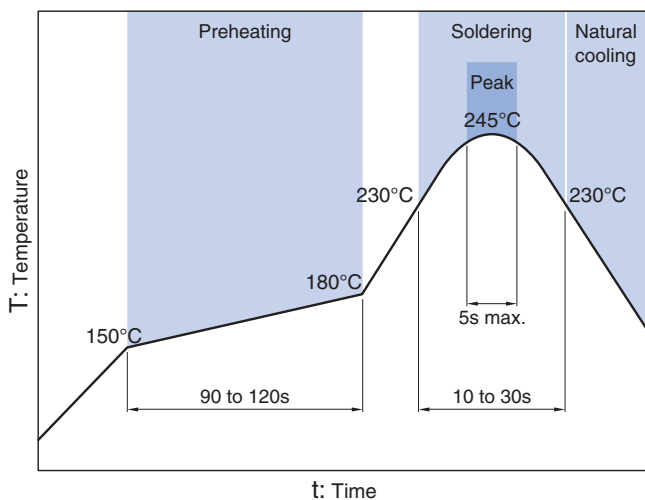

PACKAGING STYLE

REEL DIMENSIONS

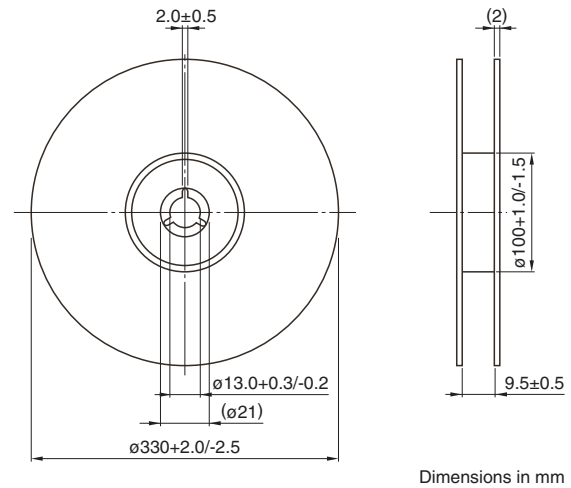

TAPE DIMENSIONS

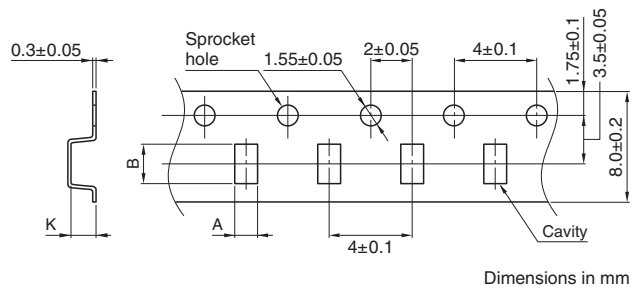

Type	A	B	K
ADL3225V	(2.9)	(3.6)	(2.5)

PACKAGE QUANTITY

Package quantity	5000 pcs/reel
------------------	---------------

TEMPERATURE RANGE, INDIVIDUAL WEIGHT

Operating temperature range*	Storage temperature range	Individual weight
-40 to +105 °C	-40 to +105 °C	0.074 g

* Operating temperature range includes self-temperature rise.

REMINDERS FOR USING THESE PRODUCTS

Before using these products, be sure to request the delivery specifications.

SAFETY REMINDERS

Please pay sufficient attention to the warnings for safe designing when using this products.

REMINDERS

- The storage period is within 12 months. Be sure to follow the storage conditions (temperature: 5 to 40°C, humidity: 10 to 75% RH or less).
If the storage period elapses, the soldering of the terminal electrodes may deteriorate.
- Do not use or store in locations where there are conditions such as gas corrosion (salt, acid, alkali, etc.).
- Before soldering, be sure to preheat components.
The preheating temperature should be set so that the temperature difference between the solder temperature and chip temperature does not exceed 150°C.
- Soldering corrections after mounting should be within the range of the conditions determined in the specifications.
If overheated, a short circuit, performance deterioration, or lifespan shortening may occur.
- When embedding a printed circuit board where a chip is mounted to a set, be sure that residual stress is not given to the chip due to the overall distortion of the printed circuit board and partial distortion such as at screw tightening portions.
- Self heating (temperature increase) occurs when the power is turned ON, so the tolerance should be sufficient for the set thermal design.
- Carefully lay out the coil for the circuit board design of the non-magnetic shield type.
A malfunction may occur due to magnetic interference.
- Use a wrist band to discharge static electricity in your body through the grounding wire.
- Do not expose the products to magnets or magnetic fields.
- Do not use for a purpose outside of the contents regulated in the delivery specifications.
- The products listed on this catalog are intended for use in general electronic equipment (AV equipment, telecommunications equipment, home appliances, amusement equipment, computer equipment, personal equipment, office equipment, measurement equipment, industrial robots) under a normal operation and use condition.
The products are not designed or warranted to meet the requirements of the applications listed below, whose performance and/or quality require a more stringent level of safety or reliability, or whose failure, malfunction or trouble could cause serious damage to society, person or property.
If you intend to use the products in the applications listed below or if you have special requirements exceeding the range or conditions set forth in the each catalog, please contact us.

- (1) Aerospace/aviation equipment
- (2) Transportation equipment (electric trains, ships, etc.)
- (3) Medical equipment
- (4) Power-generation control equipment
- (5) Atomic energy-related equipment
- (6) Seabed equipment
- (7) Transportation control equipment

- (8) Public information-processing equipment
- (9) Military equipment
- (10) Electric heating apparatus, burning equipment
- (11) Disaster prevention/crime prevention equipment
- (12) Safety equipment
- (13) Other applications that are not considered general-purpose applications

When designing your equipment even for general-purpose applications, you are kindly requested to take into consideration securing protection circuit/device or providing backup circuits in your equipment.