



PXIE-SCP5105 Bundle

Expandable PXI bundle based on PXIe-5162
Oscilloscope, 1.5 GHz, 10 bits, 4 Channels, 2 GB

Specifications

PXIE-1083 and PXIe-5162

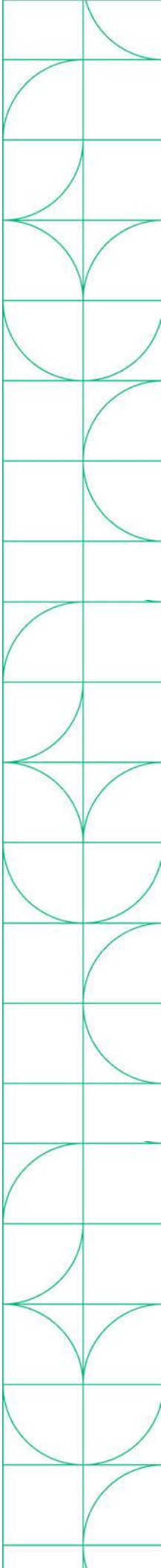

PXI Oscilloscope Bundle

In the Box

PXIe-SCP5105 Bundle

Bundle P/N: 867015-01



PXIe-5162
(Oscilloscope)



PXIe-1083
(5-Slot PXIe Chassis)

Accessories:

- SP500X probe (x4)
- Thunderbolt cable
- Power cable, US

Recommended Software

Test Workflow P/N: 788509-35



Test Workflow is a bundle of select NI software featuring engineering-specific tools that help test professionals accomplish anything from their day-to-day work to overcoming their most challenging obstacles.

Test Workflow includes:

- **LabVIEW** - a graphical programming environment engineers use to develop automated research, validation, and production test systems.
- **InstrumentStudio** - an application software that provides an integrated approach to interactive PXI measurements.
- **TestStand** - a test executive software that accelerates system development and deployment for engineers in validation and production.
- And more NI Software!

Table of Contents

This document combines the PDFs of this bundle together. The page numbers in the table of contents correspond to the page number of PDF the component's documentation begins.

PXIe-1083 Specifications.....	3
PXIe-5162 Specifications.....	16

PXle-1083 Specifications



PXIe-1083 Specifications

This document contains specifications for the PXIe-1083 chassis.

Electrical

The following section provides information about the PXIe-1083 AC input and DC output.

AC Input

Input rating	100 VAC to 240 VAC, 50 Hz/60 Hz, 6 A to 3 A
Operating voltage range ¹	90 VAC to 264 VAC
Nominal input frequency	50 Hz/60 Hz
Operating frequency range ¹	47 Hz to 63 Hz
Efficiency	78% typical
Over-current protection	Internal fuse in line
Main power disconnect	The AC power cable provides main power disconnect. Do not position the equipment so that it is difficult to disconnect the power cord. The front-panel power switch causes the internal chassis power supply to provide DC power to the PXI Express backplane.



Caution Disconnect power cord to completely remove power.

DC Output

DC output characteristics of the PXIe-1083.

Voltage Rail	Maximum Current	Load Regulation	Maximum Ripple and Noise (20 MHz BW)
+5V_AUX	1.0 A	±5%	50 mVpp
+12 V	30.1 A	±5%	120 mVpp
+5 V	25.1 A	±5%	50 mVpp
+3.3 V	30.7 A	±5%	50 mVpp
-12 V	0.75 A	±5%	120 mVpp

Maximum total available power for the PXIe-1083 is 293 W.

The maximum combined power available on +3.3 V and +5 V is 180 W.

The maximum power available for each Thunderbolt port is 15 W (5 V/3 A).

Table 1. Backplane Slot Current Capacity

Slot	+5 V	V (I/O)	+3.3 V	+12 V	-12 V	5 V _{AUX}
Hybrid Peripheral Slot with PXI-5 Peripheral	-	-	3 A	6 A	-	1 A
Hybrid Peripheral Slot with PXI-1 Peripheral	6 A	5 A	6 A	1 A	1 A	-



Note PCI V(I/O) pins in Hybrid Peripheral Slots are connected to +5 V.



Note The maximum power dissipated in a peripheral slot should not exceed 58 W. Refer to the **Operating Environment** section for ambient temperature considerations at 58 W.

Over-current protection	All outputs are protected from short circuit and overload, they recover and return to regulation when the overload is removed and the power is cycled.
Over-voltage protection	+3.3 V clamped at 3.7 V to 4.3 V, +5 V clamped at 5.7 V to 6.5 V, +12 V clamped at 13.4 V to 15.6 V

Chassis Cooling

Module cooling	Forced air circulation (positive pressurization) through one 150 CFM fan
Module slot airflow direction	Bottom of module to top of module
Module intake	Bottom of chassis
Module exhaust	Top, right side of chassis
Slot cooling capacity	58 W; slot 6 supports 58 W cooling with high fan mode
Power supply cooling	Forced air circulation through integrated fans
Power supply intake	Front and left side chassis
Power supply exhaust	Rear of chassis
Minimum chassis cooling clearances	
Above	44.45 mm (1.75 in.)
Rear	44.45 mm (1.75 in.)
Sides	44.45 mm (1.75 in.)
Below	
Rack	44.45 mm (1.75 in.)
Desktop	25.4 mm (1.00 in.)

Environmental

Maximum altitude	2,000 m (6,560 ft.), 800 mbar (at 25 °C ambient, high fan mode)
Pollution Degree	2

Indoor use only.

Operating Environment

<p>Ambient temperature range</p> <p>When all peripheral modules require ≤ 38 W cooling capacity per slot</p> <p>0 °C to 50 °C (IEC 60068-2-1 and IEC 60068-2-2.)² Meets MIL-PRF-28800F Class 3 low temperature limit and high temperature limit.</p> <p>When any peripheral module requires > 38 W cooling capacity per slot</p> <p>0 °C to 40 °C (IEC 60068-2-1 and IEC 60068-2-2.)² Meets MIL-PRF-28800F Class 3 low temperature limit and MIL-PRF-28800F Class 4 high temperature limit.</p>	
Relative humidity range	20% to 80%, noncondensing

Storage Environment

Ambient temperature range	-40 °C to 71 °C (IEC-60068-2-1 and IEC-60068-2-2.) ^[3] Meets MIL-PRF-28800F Class 3 limits.
Relative humidity range	10% to 95%, noncondensing

Shock and Vibration

Operational shock	30 g peak, half-sine, 11 ms pulse (IEC-60068-2-27.) ³ Meets MIL-PRF-28800F Class 2 limits.
Operational random vibration	5 to 500 Hz, 0.3 g _{rms}
Non-operating vibration	5 to 500 Hz, 2.4 g _{rms} (IEC 60068-2-64.) ³ Non-operating test profile exceeds the requirements of MIL-PRF-28800F, Class 3.

Acoustic Emissions

Sound Pressure Level (at Operator Position)

(Tested in accordance with ISO 7779. Meets MIL-PRF-28800F requirements.)

38 W Profile

Auto fan (up to 30 °C ambient)	33.7 dBA
High fan	50.8 dBA

58 W Profile

Auto fan (up to 30 °C ambient)	54.7 dBA
High fan	55.3 dBA

Sound Power Level

38 W Profile

Auto fan (up to 30 °C ambient)	44.9 dBA
High fan	60.3 dBA

58 W Profile	
Auto fan (up to 30 °C ambient)	63.4 dBA
High fan	64.2 dBA



Note The protection provided by the PXIe-1083 can be impaired if it is used in a manner not described in this document.

Safety Compliance Standards

This product is designed to meet the requirements of the following electrical equipment safety standards for measurement, control, and laboratory use:

- IEC 61010-1, EN 61010-1
- UL 61010-1, CSA C22.2 No. 61010-1



Note For safety certifications, refer to the product label or the [Product Certifications and Declarations](#) section.

EMC Guidelines

This product was tested and complies with the regulatory requirements and limits for electromagnetic compatibility (EMC) stated in the product specifications. These requirements and limits provide reasonable protection against harmful interference when the product is operated in the intended operational electromagnetic environment.

This product is intended for use in industrial locations. However, harmful interference may occur in some installations, when the product is connected to a peripheral device or test object, or if the product is used in residential areas. To minimize interference with radio and television reception and prevent unacceptable performance degradation, install and use this product in strict accordance with the instructions in the product documentation.

Furthermore, any changes or modifications to the product not expressly approved by NI could void your authority to operate it under your local regulatory rules.

EMC Notices

Refer to the following notices for cables, accessories, and prevention measures necessary to ensure the specified EMC performance.



Notice

For EMC declarations and certifications, and additional information, refer to the [Product Certifications and Declarations](#) section.



Notice Changes or modifications to the product not expressly approved by NI could void your authority to operate the product under your local regulatory rules.



Notice Operate this product only with shielded cables and accessories.

Electromagnetic Compatibility Standards

This product meets the requirements of the following EMC standards for electrical equipment for measurement, control, and laboratory use:

- EN 61326-1 (IEC 61326-1): Class A emissions; Basic immunity
- EN 55011 (CISPR 11): Group 1, Class A emissions

- AS/NZS CISPR 11: Group 1, Class A emissions



Note Group 1 equipment (per CISPR 11) is any industrial, scientific, or medical equipment that does not intentionally generate radio frequency energy for the treatment of material or inspection/analysis purposes.



Note In Europe, Canada, Australia, and New Zealand (per CISPR 11) Class A equipment is intended for use in nonresidential locations.

CE Compliance

This product meets the essential requirements of applicable European Directives, as follows:

- 2014/35/EU; Low-Voltage Directive (safety)
- 2014/30/EU; Electromagnetic Compatibility Directive (EMC)
- 2011/65/EU; Restriction of Hazardous Substances (RoHS)

Product Certifications and Declarations

Refer to the product Declaration of Conformity (DoC) for additional regulatory compliance information. To obtain product certifications and the DoC for NI products, visit ni.com/product-certifications, search by model number, and click the appropriate link.

Environmental Management

NI is committed to designing and manufacturing products in an environmentally responsible manner. NI recognizes that eliminating certain hazardous substances from our products is beneficial to the environment and to NI customers.

For additional environmental information, refer to the **Engineering a Healthy Planet** web page at ni.com/environment. This page contains the environmental

regulations and directives with which NI complies, as well as other environmental information not included in this document.

EU and UK Customers

-  Waste Electrical and Electronic Equipment (WEEE)—At the end of the product life cycle, all NI products must be disposed of according to local laws and regulations. For more information about how to recycle NI products in your region, visit ni.com/environment/weee.

电子信息产品污染控制管理办法 (中国 RoHS)

-  中国 RoHS— NI 符合中国电子信息产品中限制使用某些有害物质指令(RoHS)。关于 NI 中国 RoHS 合规性信息，请登录 ni.com/environment/rohs_china。(For information about China RoHS compliance, go to ni.com/environment/rohs_china.)

Backplane

Size	3U-sized; 5 peripheral slots. Compliant with IEEE 1101.10 mechanical packaging. PXI Express Specification compliant. Accepts both PXI Express and CompactPCI (PICMG 2.0 R 3.0) 3U modules.
Backplane bare-board material	UL 94 V-0 Recognized
Backplane connectors	Conforms to IEC 917 and IEC 1076-4-101, UL 94 V-0 rated

System Synchronization Clocks

10 MHz System Reference Clock: PXI_CLK10

Maximum slot-to-slot skew	250 ps
Accuracy	± 25 ppm max (guaranteed over the operating temperature range)
Maximum jitter	5 ps RMS phase-jitter (10 Hz–1 MHz range)
Duty-factor	45% to 55%
Unloaded signal swing	3.3 V \pm 0.3 V



Note For other specifications, refer to the **PXI-1 Hardware Specification**.

100 MHz System Reference Clock: PXIe_CLK100 and PXIe_SYNC100

Maximum slot-to-slot skew	100 ps
Accuracy	± 25 ppm max (guaranteed over the operating temperature range)
Maximum jitter	3 ps RMS phase-jitter (10 Hz to 12 kHz range), 2 ps RMS phase-jitter (12 kHz to 20 MHz range)
Duty-factor for PXIe_CLK100	45% to 55%
Absolute differential voltage (When terminated with a 50 Ω load to 1.30 V or Thévenin equivalent)	400 mV to 1000 mV



Note For other specifications, refer to the **PXI-5 PXI Express Hardware Specification**.

Mechanical

Standard chassis dimensions	
Height	177.1 mm (6.97 in.)
Width	257.1 mm (10.12 in.)
Depth	214.2 mm (8.43 in.)
Weight	6.7 kg (14.8 lb)
Chassis materials	Extruded Aluminum (6063-T5, 6060-T6), Cold Rolled Steel/Stainless Steel, Santoprene, Urethane Foam, PC-ABS, Nylon, Polyethylene
Finish	Conductive Clear Iridite on Aluminum, Electroplated Nickel on Cold Rolled Steel, Electroplated Zinc on Cold Rolled Steel

The following figures show the PXIe-1083 chassis dimensions. The holes shown are for installing the optional rack mount kits.

Figure 1. PXIe-1083 Chassis Dimensions (Front)

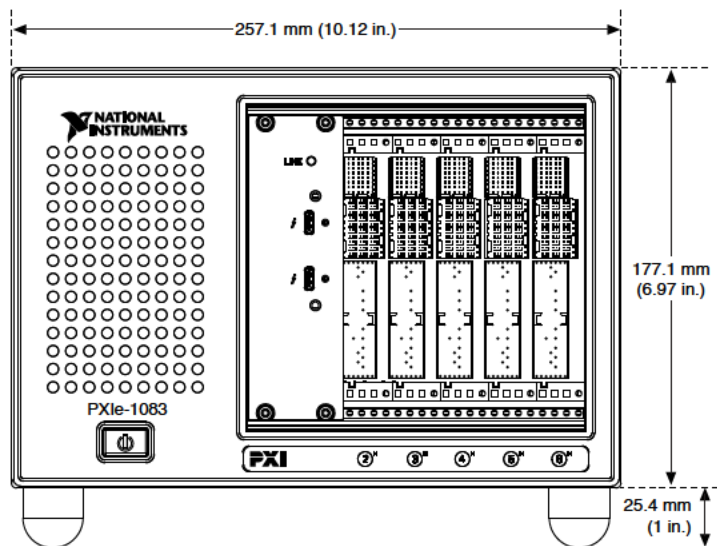

Figure 2. PXIe-1083 Chassis Dimensions (Side)

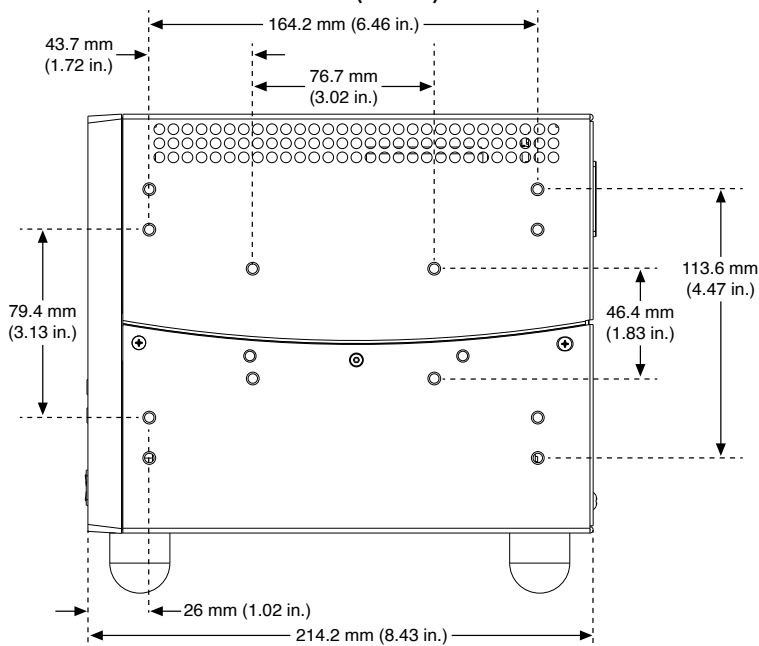
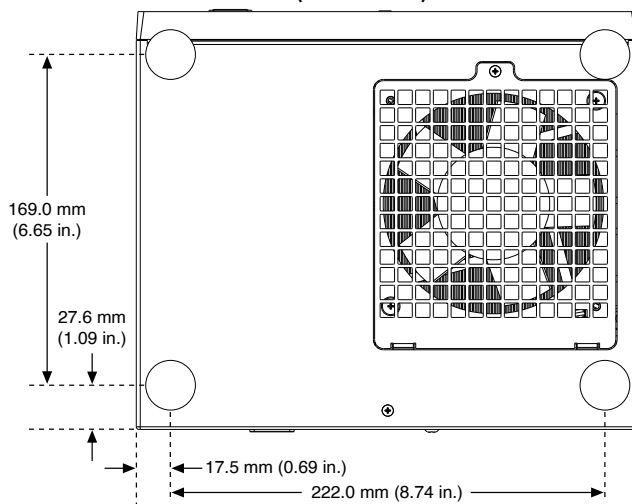

Figure 3. PXIe-1083 Chassis Dimensions (Bottom)



¹ The operating range is guaranteed by design.

² This product meets the requirements of the environmental standards for electrical equipment for measurement, control, and laboratory use.

³ This product meets the requirements of the environmental standards for electrical equipment for measurement, control, and laboratory use.

PXle-5162

Specifications



PXIe-5162 Specifications

Definitions

Warranted specifications describe the performance of a model under stated operating conditions and are covered by the model warranty. **Warranted** specifications account for measurement uncertainties, temperature drift, and aging. **Warranted** specifications are ensured by design, or verified during production and calibration.

Characteristics describe values that are relevant to the use of the model under stated operating conditions but are not covered by the model warranty.

- **Typical** specifications describe the performance met by a majority of models.
- **Nominal** specifications describe an attribute that is based on design, conformance testing, or supplemental testing.
- **Measured (meas)** specifications describe the measured performance of a representative model.

Specifications are **Typical** unless otherwise noted.

Conditions

Specifications are valid under the following conditions unless otherwise noted.

- All vertical ranges
- All bandwidths and bandwidth limit filters
- Sample rate set to 1.25 GS/s, 2.5 GS/s, or 5 GS/s
- Onboard Sample clock locked to onboard Reference clock

Warranted specifications are valid under the following conditions unless otherwise noted.

- Ambient temperature ranges of 0 °C to 45 °C
- The PXIe-5162 is warmed up for 15 minutes at ambient temperature
- Self-calibration is completed after warm-up period
- Calibration cycle is maintained
- The PXI Express chassis fan speed is set to HIGH, the foam fan filters are removed if present, and the empty slots contain PXI chassis slot blockers and filler panels. For more information about cooling, refer to the Maintain Forced-Air Cooling Note to Users document available at ni.com/manuals.
- NI-SCOPE 4.1 or later instrument driver is used
- External calibration is performed at 23 °C ± 3 °C

Typical specifications are valid under the following conditions unless otherwise noted:

- Ambient temperature ranges of 0 °C to 45 °C

Vertical

Analog Input

Number of channels	
PXIe-5162 (2 CH)	Two (simultaneously sampled)
PXIe-5162 (4 CH)	Four (simultaneously sampled)
Input type	Referenced single-ended
Connectors	BNC

Impedance and Coupling



Note Impedance and coupling are software-selectable on a per-channel basis.

Table 1. Input Impedance

Impedance Setting	Typical	Warranted
50 Ω	50 $\Omega \pm 1.50\%$	50 $\Omega \pm 1.75\%$
1 M Ω	1 M $\Omega \pm 0.75\%$	1 M $\Omega \pm 0.90\%$
Input capacitance ^[1]	15 pF \pm 0.8 pF, nominal 15 pF \pm 2.5 pF, warranted	
Input coupling	AC, DC	

Figure 1. 50 Ω Input Return Loss and Input VSWR, Measured

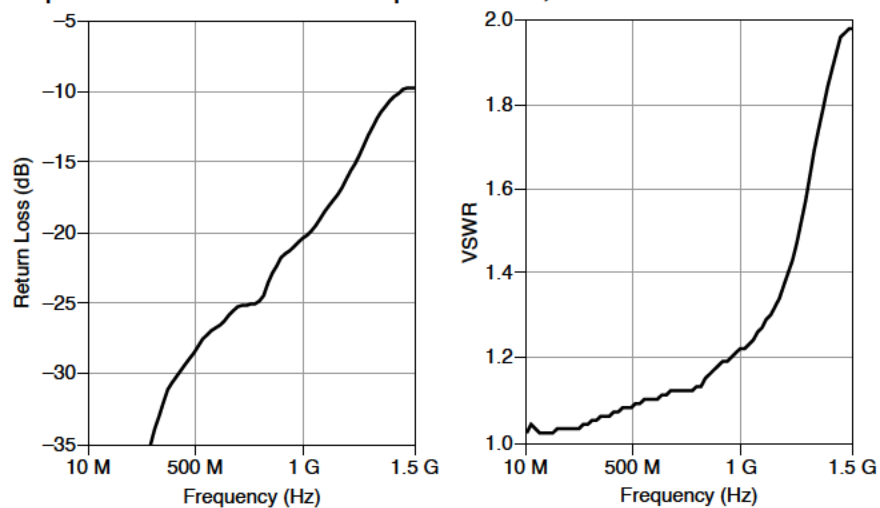

Voltage Levels

Table 2. 50 Ω Full-Scale (FS) Input Range and Vertical Offset Range

Input Range (V_{pk-pk})	Vertical Offset Range (V)
0.05 V	± 0.5

Input Range (V_{pk-pk})	Vertical Offset Range (V)
0.1 V	± 0.5
0.2 V	± 0.5
0.5 V	± 0.5
1 V	± 0.5
2 V	± 1.5
5 V	0

Table 3. 1 M Ω FS Input Range and Vertical Offset Range

Input Range (V_{pk-pk})	Vertical Offset Range (V)
0.05 V	± 0.5
0.1 V	± 0.5
0.2 V	± 0.5
0.5 V	± 0.5
1 V	± 0.5
2 V	± 5
5 V	± 5
10 V	± 5
20 V	± 30
50 V	± 15

Maximum input overload^[2]

50 Ω |Peaks| ≤ 5 V, nominal

1 M Ω |Peaks| ≤ 42 V, nominal

Accuracy

Resolution	10 bits
DC accuracy ^[3]	$\pm [(2\% \times \mathbf{Reading} - \mathbf{Vertical\ Offset}) + (1.4\% \times \mathbf{Vertical\ Offset}) + (0.6\% \text{ of } \mathbf{FS}) + 600 \mu\text{V}]$

DC drift ^[4]	$\pm[(0.1\% \times \text{Reading} - \text{Vertical Offset}) + (0.025\% \times \text{Vertical Offset}) + (0.03\% \text{ of FS})]$ per °C, nominal
AC amplitude accuracy ^[3]	± 0.5 dB at 50 kHz
AC amplitude drift ^[4]	± 0.01 dB per °C at 50 kHz, nominal

Table 4. Channel-to-Channel Crosstalk, Nominal^[5]

Input Impedance	Input Frequency	Crosstalk
50 Ω	DC $\leq f \leq 100$ MHz	-60 dB
	100 MHz $< f \leq 700$ MHz	-45 dB
	700 MHz $< f \leq 1000$ MHz	-40 dB
1 M Ω ^[6]	DC $\leq f \leq 100$ MHz	-55 dB
	100 MHz $< f \leq 200$ MHz	-45 dB

Bandwidth and Transient Response

50 Ω bandwidth (-3 dB) ^[7]	1.5 GHz, warranted
--	--------------------

Table 5. 1 M Ω Bandwidth (-3 dB)^[11]

Input Impedance	Input Range (V_{pk-pk})	Nominal	Warranted
1 M Ω ^[9]	0.05 V to 1 V	—	300 MHz
	2 V to 10 V	300 MHz	250 MHz ^[10]
	20 V to 50 V	300 MHz	—

Bandwidth-limiting filters	20 MHz 175 MHz
----------------------------	-------------------

Rise/fall time ^[12] 50 Ω	320 ps
--	--------

$1\text{ M}\Omega$ ^[13]	1.4 ns
AC-coupling cutoff (-3 dB) ^[14]	
$50\ \Omega$ ^[15]	170 kHz
$1\text{ M}\Omega$	17 Hz

Figure 2. PXIe-5162 Step Response, $50\ \Omega$, $1\text{ V}_{\text{pk-pk}}$ Input Range, -0.25 V Programmable Offset, 150 ps Rising Edge, Measured

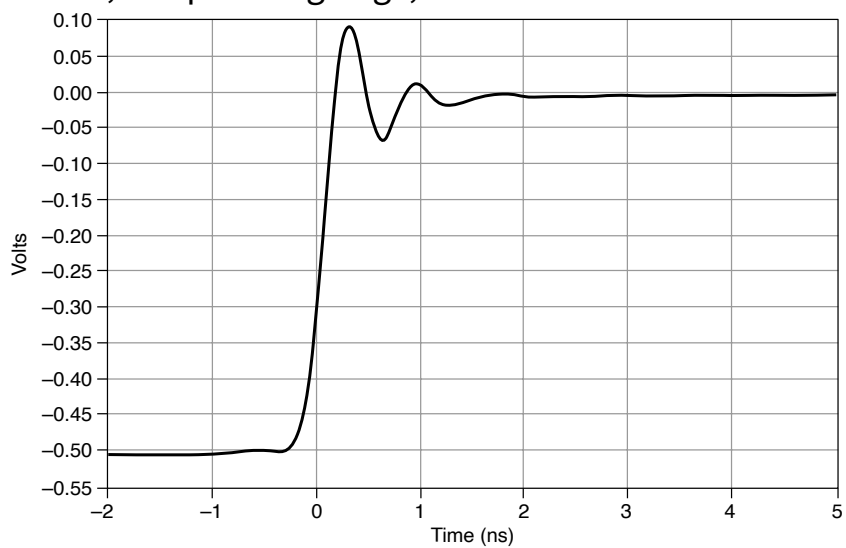

Figure 3. PXIe-5162 Step Response, $1\text{ M}\Omega$, $1\text{ V}_{\text{pk-pk}}$ Input Range, -0.25 V Programmable Offset, 500 ps Rising Edge, Measured [\[16\]](#)

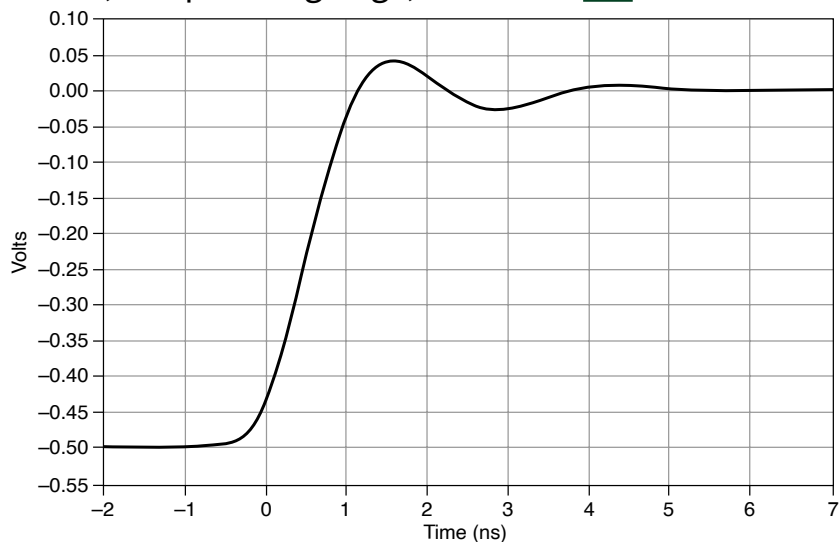

Figure 4. PXIe-5162 $50\ \Omega$ Frequency Response, $1\text{ V}_{\text{pk-pk}}$, 5 GS/s , Measured

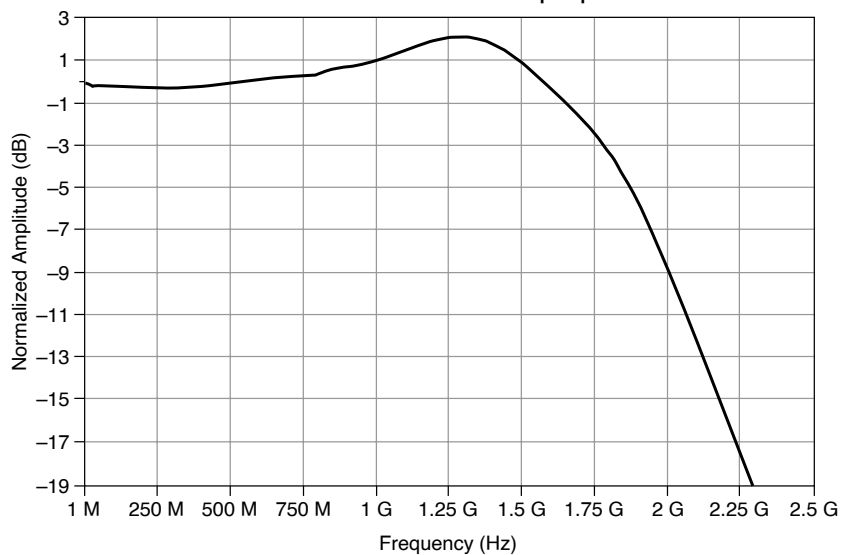

Figure 5. PXIe-5162 1 M Ω Frequency Response, 1 V_{pk-pk}, Measured [\[17\]](#)

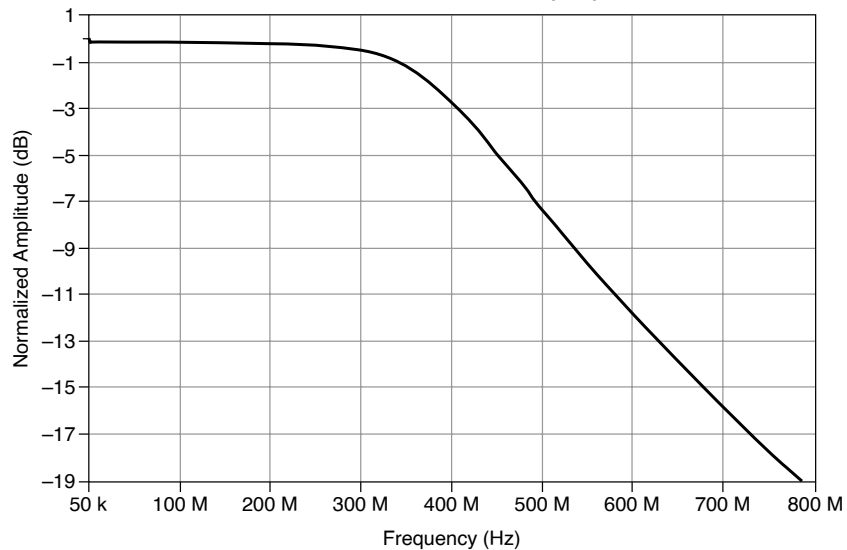
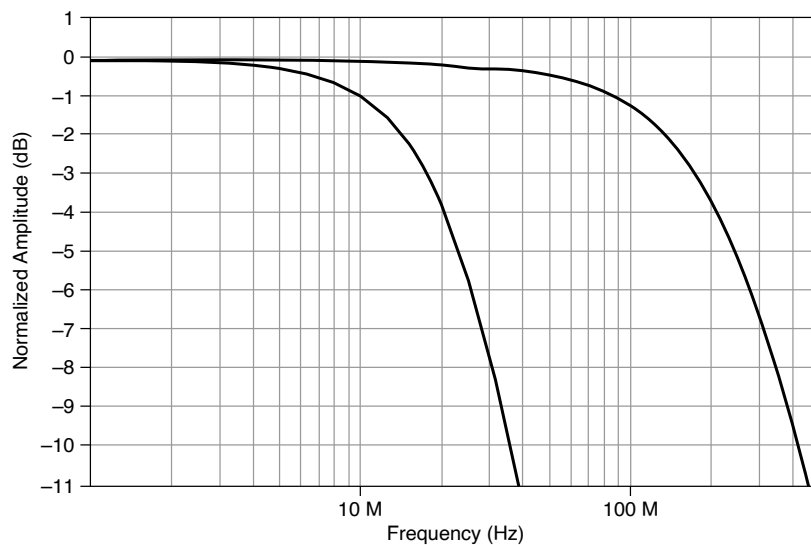

Figure 6. PXIe-5162 Bandwidth-Limiting Filters Frequency Response, 1 V_{pk-pk}, Measured



Spectral Characteristics

50 Ω Spectral Characteristics

Table 6. Spurious-Free Dynamic Range (SFDR), Measured^[18]

Input Frequency	Input Range (V_{pk-pk})	SFDR	
		1.25 GS/s, 2.5 GS/s ^[19] , 5.0 GS/s ^[19]	2.5 GS/s, 5.0 GS/s
<10 MHz	0.05 V	52 dBc	40 dBc
	0.1 V	52 dBc	46 dBc
	0.2 V	56 dBc	46 dBc
	0.5 V to 5 V	56 dBc	50 dBc
≥ 10 MHz to ≤ 1 GHz	0.05 V	46 dBc	40 dBc
	0.1 V to 5 V	46 dBc	46 dBc

Table 7. Effective Number of Bits (ENOB), Nominal^[18]

Input Frequency	Input Range (V_{pk-pk})	ENOB
<1 GHz	0.05 V	6.0
	0.1 V	6.6
	0.2 V to 5 V	7.0

Figure 7. PXIe-5162 Single-Tone Spectrum, 2.98 dBm Input Signal at Connector, 50 Ω , 1 V_{pk-pk} , 5 GS/s, 300 MHz Input Tone, Full Bandwidth, Measured

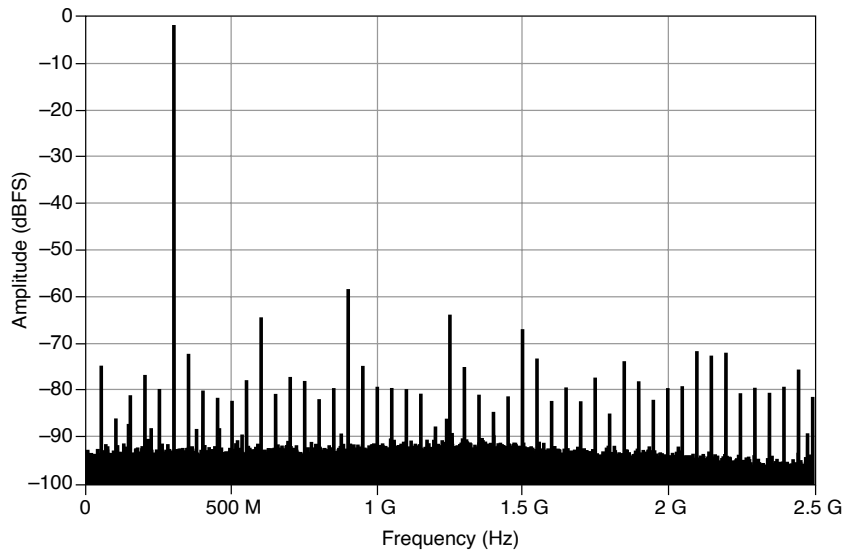

1 M Ω Spectral Characteristics^[20]

Table 8. SFDR, Nominal^[21]

Input Frequency	Input Range (V_{pk-pk})	SFDR	
		1.25 GS/s, 2.5 GS/s ^[22] , 5.0 GS/s ^[22]	2.5 GS/s, 5.0 GS/s
<10 MHz	0.05 V to 10 V	53 dBc	48 dBc
	20 V	50 dBc	44 dBc
≥ 10 MHz to ≤ 100 MHz	0.05 V to 0.5 V	53 dBc	48 dBc
	1 V to 5 V	48 dBc	48 dBc

Table 9. ENOB, Nominal^[21]

Input Frequency	Input Range (V_{pk-pk})	ENOB
<10 MHz	10 V to 20 V	7.1
≤ 100 MHz	0.05 V	6.2
	0.1 V	6.8
	0.2 V to 5 V	7.1

Noise

Table 10. RMS Noise^[23]

Input Impedance	Input Range (V_{pk-pk})	Typical	Warranted
50 Ω	0.05 V	0.55% of FS	0.62% of FS
	0.1 V	0.33% of FS	0.39% of FS
	0.2 V to 5 V	0.28% of FS	0.34% of FS
1 M Ω	0.05 V	0.55% of FS	0.62% of FS
	0.1 V	0.33% of FS	0.39% of FS
	0.2 V to 50 V	0.28% of FS	0.34% of FS

Skew

Channel-to-channel skew

50 Ω to 50 Ω

<25 ps, nominal

1 M Ω to 1 M Ω	<125 ps, nominal
50 Ω to 1 M Ω	<800 ps, nominal

Horizontal

Sample Clock

Sources

Internal	Onboard clock (internal VCO)
External	Front panel SMB connector

Onboard Clock

Real-time sample rate range^[24]

One channel enabled	76.299 kS/s to 5 GS/s
Two channels enabled ^[25]	76.299 kS/s to 2.5 GS/s
Four channels enabled	76.299 kS/s to 1.25 GS/s

Random interleaved sampling (RIS) range ^[26]	Up to 100 GS/s
---	----------------

Figure 8. PXIe-5162 Phase Noise (Plotted without Spurs) at 1 GHz, 3 dBm Input Signal, Locked to Onboard Reference Clock, Measured

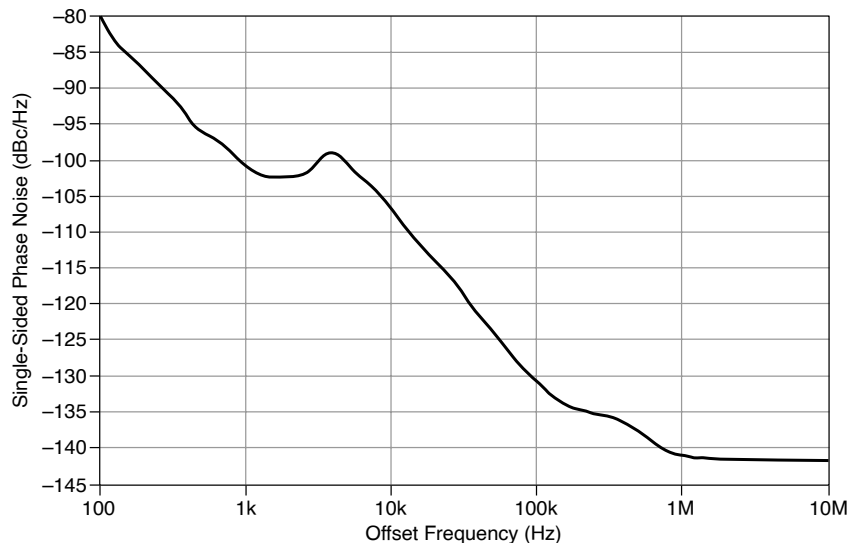

Sample Clock jitter ^[27]	180 fs RMS (12 kHz to 10 MHz), nominal
Timebase frequency	2.5 GHz
Timebase accuracy ^[28]	±10 ppm, typical ±25 ppm, warranted

Phase-Locked Loop (PLL) Reference Clock

Sources	
Internal Onboard 10 MHz reference	
External External 10 MHz (front panel CLK IN connector) or PXI_CLK10 (backplane connector)	
Duty cycle tolerance	45% to 55%

External Sample Clock (CLK IN, Front Panel Connector)

Input voltage range, when configured as a Sample Clock	-10 dBm through 16 dBm
Maximum input overload, when configured as a Sample Clock	18 dBm
Impedance	50 Ω
Coupling	AC
Frequency range	1.25 GHz to 2.5 GHz ^[29]

External Reference Clock In (CLK IN, Front Panel Connector)

Input voltage range, when configured as a Reference Clock	200 mV _{pk-pk} to 4 V _{pk-pk}
Maximum input overload, when configured as a Reference Clock	5 V _{pk-pk} with Peaks \leq 10 V
Impedance	50 Ω
Coupling	AC
Frequency range ^[30]	10 MHz

Reference Clock Out (CLK OUT, Front Panel Connector)

Output impedance	50 Ω
Logic type	3.3 V CMOS

Maximum current drive	±10 mA
-----------------------	--------

Trigger

Supported trigger	Reference (Stop) Trigger
Trigger types	Edge Digital Immediate Hysteresis Software
<p>Trigger sources</p> <p>PXIe-5162 (2 CH) CH 0, CH 1, TRIG, PFI 0, PFI 1, PXI_TRIG <0..6>, and Software</p> <p>PXIe-5162 (4 CH) CH 0, CH 1, CH 2, CH 3, PFI 0, PFI 1, PXI_TRIG <0..6>, and Software</p>	
Time-to-digital conversion circuit time resolution	4 ps
Dead time	710 ns, nominal
Holdoff	6.4 ns to 27.4 s
Trigger delay	From 0 to 73,786,976 seconds (28 months), nominal

Analog Trigger (Edge Trigger Type)

Sources	
PXIe-5162 (2 CH)	CH 0, CH 1, or TRIG ^[31]
PXIe-5162 (4 CH)	CH 0, CH 1, CH 2, or CH 3
Trigger filters	
Low-frequency reject	150 kHz, nominal
High-frequency reject	150 kHz, nominal
Trigger sensitivity	3% of FS at ≤ 100 MHz, nominal
Trigger accuracy ^[32]	6% of FS at ≤ 100 MHz, nominal
Trigger jitter	4.7 ps

External Trigger (TRIG, Front Panel Connector)



Note TRIG is valid only for the PXIe-5162 (2 CH) device.

Connector	BNC
Impedance	50 Ω or 1 M Ω
Coupling	AC or DC
Input voltage range	

50 Ω	± 2.5 V
1 M Ω	± 5 V
Maximum input overload	
50 Ω	Peaks ≤ 5 V, nominal
1 M Ω	Peaks ≤ 42 V, nominal
Trigger sensitivity	3% of FS at ≤ 100 MHz, nominal
Trigger accuracy ^[33]	8% of FS at ≤ 100 MHz, nominal
Trigger jitter	4.7 ps

Digital Trigger (Digital Trigger Type)

Sources^[34]	
Front panel SMB connector	PFI <0..1>
Backplane connector	PXI_TRIG <0..6>

Programmable Function Interface (PFI 0 and PFI 1, Front Panel Connectors)

Connector	SMB jack
Direction	Bidirectional

As an Input (Trigger)

Destinations	Start Trigger (Acquisition Arm) Reference (Stop) Trigger Advance Trigger
Input impedance	10 k Ω
V _{IH}	2.0 V
V _{IL}	0.8 V
Maximum input overload	-0.5 V to 5.5 V
Maximum frequency	25 MHz

As an Output (Event)

Sources	Ready for Start Start Trigger (Acquisition Arm) Ready for Reference Arm Reference Trigger Reference (Stop) Trigger End of Record Ready for Advance
---------	--

	Advance Trigger Done (End of Acquisition) Probe Compensation ^[35]
Output impedance	50 Ω , nominal
Logic type	3.3 V CMOS
Maximum current drive	± 10 mA
Maximum frequency	25 MHz

CableSense

CableSense pulse voltage ^[36]	0.5 V, nominal
CableSense pulse rise time ^[37]	650 ps, nominal

Driver support for CableSense on the PXIe-5162 was first available in NI-SCOPE18.7.

Related information

- [For more information about CableSense technology, refer to ni.com/cablesense.](http://ni.com/cablesense)

Waveform Specifications

Onboard memory sizes ^[38]	2 GB
Minimum record length	1 sample

Number of pretrigger samples ^[39]	Zero up to full record length
Number of posttrigger samples ^[39]	Zero up to full record length
Maximum number of records in onboard memory^[40]	
2 GB	100,000
Allocated onboard memory per record	$[(\text{Record length} + 448 \text{ samples}) \times 2 \text{ bytes/sample}]$, rounded up to an integer multiple of 128 bytes (minimum 512 bytes)

Memory Sanitization

For information about memory sanitization, refer to the letter of volatility for your device, which is available at ni.com/manuals.

Calibration

External Calibration

External calibration calibrates the onboard references used in self-calibration and the external trigger levels. All calibration constants are stored in nonvolatile memory.

Self-Calibration

Self-calibration is done on software command. The calibration corrects for gain, offset, triggering, and timing errors for all input ranges.

Calibration Specifications

Interval for external calibration	2 years
Warm-up time ^[41]	15 minutes

Software

Driver Software

Driver support for this device was first available in NI-SCOPE4.1.

NI-SCOPE is an IVI-compliant driver that allows you to configure, control, and calibrate the PXIe-5162. NI-SCOPE provides application programming interfaces for many development environments.

Application Software

NI-SCOPE provides programming interfaces, documentation, and examples for the following application development environments:

- LabVIEW
- LabWindows™/CVI™
- Measurement Studio
- Microsoft Visual C/C++
- .NET (C# and VB.NET)

Interactive Soft Front Panel and Configuration

When you install NI-SCOPE on a 64-bit system, you can monitor, control, and record measurements from the PXIe-5162 using InstrumentStudio.

InstrumentStudio is a software-based front panel application that allows you to perform interactive measurements on several different device types in a single program.



Note InstrumentStudio is supported only on 64-bit systems. If you are using a 32-bit system, use the NI-SCOPE-specific soft front panel instead of InstrumentStudio.

Interactive control of the PXIe-5162 was first available via InstrumentStudio in NI-SCOPE18.1 and via the NI-SCOPE SFP in NI-SCOPE4.1. InstrumentStudio and the NI-SCOPE SFP are included on the NI-SCOPE media.

NI Measurement & Automation Explorer (MAX) also provides interactive configuration and test tools for the PXIe-5162. MAX is included on the driver media.

TClk Specifications

You can use the NI TClk synchronization method and the NI-TClk driver to align the Sample clocks on any number of supported devices, in one or more chassis. For more information about TClk synchronization, refer to the **NI-TClk Synchronization Help**, which is located within the **NI High-Speed Digitizers Help**. For other configurations, including multichassis systems, contact NI Technical Support at ni.com/support.

Intermodule SMC Synchronization Using NI-TClk for Identical Modules

Specifications are valid under the following conditions:

- All modules are installed in one PXI Express chassis.
- The NI-TClk driver is used to align the Sample clocks of each module.
- All parameters are set to identical values for each SMC-based module.
- Modules are synchronized without using an external Sample clock.
- Self-calibration is completed.



Note Although you can use NI-TClk to synchronize non-identical SMC-based modules, these specifications apply only to synchronizing identical modules.

Skew ^[42]	100 ps, nominal
Skew after manual adjustment	≤5 ps, nominal
Sample clock delay/adjustment resolution	20 fs

Power Requirements

+3.3 VDC	2.2 A, nominal
+12 VDC	2.3 A, nominal
Total power	34.8 W, nominal

Physical Characteristics

Dimensions	3U, 1 slot, PXI Express gen 1 x4 Module 21.4 cm × 2.0 cm × 13.1 cm (8.4 in. × 0.8 in. × 5.1 in.)
Weight	430 g (15 oz.)

Environmental Characteristics

Temperature

Operating	0 °C to 45 °C
Storage	-40 °C to 71 °C
Humidity	
Operating	10% to 90%, noncondensing
Storage	5% to 95%, noncondensing
Pollution Degree	2
Maximum altitude	2,000 m (800 mbar) (at 25 °C ambient temperature)
Shock and Vibration	
Operating vibration	5 Hz to 500 Hz, 0.3 g RMS
Non-operating vibration	5 Hz to 500 Hz, 2.4 g RMS
Operating shock	30 g, half-sine, 11 ms pulse

Product Certifications and Declarations

Refer to the product Declaration of Conformity (DoC) for additional regulatory compliance information. To obtain product certifications and the DoC for NI products, visit ni.com/product-certifications, search by model number, and click the appropriate link.

¹ 1 MΩ input only.

² Signals exceeding the maximum input overload may cause damage to the device.

³ Within ± 3 °C of self-calibration temperature. This specification is **typical** for peak-to-peak input ranges of 0.05 V to 0.1 V and **warranted** for all other input ranges.

⁴ Used to calculate errors when onboard temperature changes more than ± 3 °C from the self-calibration temperature.

⁵ Measured on one channel with test signal applied to another channel with the same range setting on both channels.

⁶ Only valid on peak-to-peak input ranges of 0.05 V to 10 V.

⁷ Normalized to 50 kHz.

⁸ For ambient temperature ranges of 0 °C to 30 °C

⁹ Verified using a 50 Ω source and 50 Ω feed-through terminator.

¹⁰ For ambient temperature ranges of 0 °C to 30 °C

¹¹ Normalized to 50 kHz.

¹² 50% FS input pulse.

¹³ Verified using a 50 Ω source and 50 Ω feed-through terminator.

¹⁴ Verified using a 50 Ω source.

¹⁵ With AC coupling enabled, the DC resistance to ground is 20 k Ω .

¹⁶ Verified using a 50 Ω source and 50 Ω feed-through terminator.

¹⁷ Verified using a 50 Ω source and 50 Ω feed-through terminator.

¹⁸ -1 dBFS input signal corrected to FS. Includes the second through the fifth harmonics. 7.2 kHz resolution bandwidth.

¹⁹ Excludes ADC interleaving spurs.

20 Verified using a 50 Ω source and 50 Ω feedthrough terminator.

21 -1 dBFS input signal corrected to FS. Includes the second through the fifth harmonics. 7.2 kHz resolution bandwidth.

22 Excludes ADC interleaving spurs.

23 Verified using a 50 Ω terminator connected to input.

24 Divide by **n** decimation from 1.25 GS/s used for all rates less than 1.25 GS/s. For more information about the Sample Clock and decimation, refer to the **NI High-Speed Digitizers Help**.

25 For the PXIe-5162 (4 CH), supported on channels 0 and 2. For the PXIe-5162 (2 CH), supported on channels 0 and 1.

26 With one channel enabled, stepped in multiples of 5 GS/s. With two channels enabled, stepped in multiples of 2.5 GS/s. With four channels enabled, stepped in multiples of 1.25 GS/s.

27 Includes the effects of the converter aperture uncertainty and the clock circuitry jitter. Excludes trigger jitter.

28 When phase-locked to an external Reference Clock, the timebase accuracy is equal to the external Reference Clock accuracy. For example, when locked to the System Reference Clock of a PXI Express chassis, the module inherits the accuracy of the chassis System Reference Clock.

29 To achieve the same real-time sample rate ranges as the onboard clock, a 2.5 GHz frequency is required.

30 The PLL Reference Clock frequency must be accurate to ± 25 ppm.

31 For specifications on the TRIG input, refer to the **External Trigger (TRIG, Front Panel Connector)** section.

32 When the impedance settings of the triggering input and the analog input channel are the same. Delay will increase if the impedance of the triggering input does not match the impedance of the analog input channel.

33 When the impedance settings of the triggering input and the analog input channel are the same. Delay will increase if the impedance of the triggering input does not match the impedance of the analog input channel.

34 Subsample trigger accuracy not supported on PFI 1 or PXI_TRIG<0..6>.

35 1 kHz, 50% duty cycle square wave, PFI 1 only.

36 When measured with a high-impedance device.

37 When sourcing into a 50 Ω cable or load.

38 Onboard memory is shared among all enabled channels. Devices with NI part number 154772A-x2L had 1 GB of onboard memory.

39 Single-record and multirecord acquisitions.

40 You can exceed these numbers if you fetch records while acquiring data. For more information, refer to the **NI High-Speed Digitizers Help**.

41

42 Caused by clock and analog path delay differences. No manual adjustment performed. Tested with a NI PXIe-1082 chassis with a maximum slot-to-slot skew of 100 ps.