

# CLC415

## Quad, Wideband Monolithic Op Amp

### General Description

The CLC415 is a wideband, quad, monolithic operational amplifier designed for intermediate gain applications where power and cost per channel of are primary concern. Benefiting from **National's** current feedback architecture, the CLC415 offers a gain range of  $\pm 1$  to  $\pm 10$  while providing stable, oscillation free operation without external compensation, even at unity gain.

Operating from  $\pm 5V$  supplies, the CLC415 consumes only 50mW of power per channel, yet maintains a 160MHz small-signal bandwidth and a 1500V/ $\mu s$  slew rate. High density applications requiring an integrated solution will enjoy the CLC415's 70dB channel isolation (input referred @ 5MHz).

With its exceptional differential gain and phase, typically 0.03% and 0.03° @ 3.58MHz, the CLC415 is designed to meet the performance and cost per channel requirements of high volume composite video applications. The CLC415's large-signal bandwidth, high slew rate and high drive capability are features well suited for RGB-video applications.

The CLC415 is a quad version of the high speed CLC406 while the CLC414 is a lower power quad version of the same. Both of these quads afford the designer lower power consumption and lower cost per channel with the additional benefit of requiring less board space per amplifier.

Constructed using an advanced, complementary bipolar process and **National's** proven current feedback architectures. The CLC415 is available in several versions to meet a variety of requirements.

### Enhanced Solutions (Military/Aerospace)

SMD Number: 5962-93055

Space level versions also available.

For more information, visit <http://www.national.com/mil>

### Features

- 160MHz small signal bandwidth
- 5mA quiescent current per amplifier
- 70dB channel isolation @ 5MHz
- 0.03%/0.03° differential gain/phase
- 12ns settling to 0.1%
- 1500V/ $\mu s$  slew rate
- 2.0ns rise and fall time ( $2V_{PP}$ )
- 60mA output current per amplifier

### Applications

- Composite video distribution amps
- HDTV amplifiers
- RGB-video amplifiers
- CCD signal processing
- Active Filters
- Instrumentation differential amps
- Channelized EW

Small Signal Pulse Response

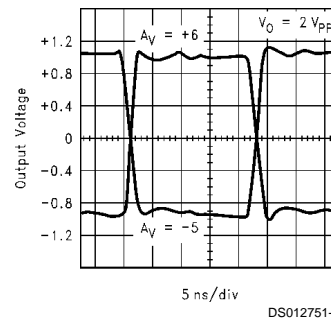

Non-Inverting Frequency Response

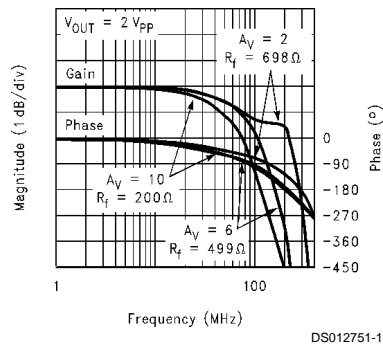

### Connection Diagram

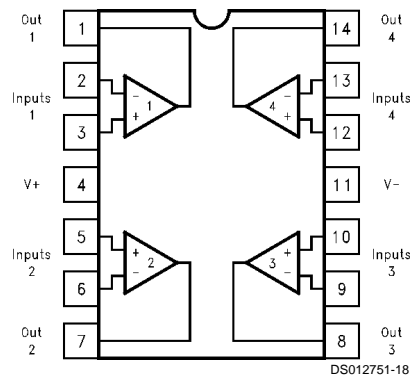

Pinout  
DIP & SOIC

## Ordering Information

Package	Temperature Range Industrial	Part Number	Package Marking	NSC Drawing
14-pin plastic DIP	-40°C to +85°C	CLC415AJP	CLC415AJP	N14A
14-pin plastic SOIC	-40°C to +85°C	CLC415AJE	CLC415AJE	M14A

**Absolute Maximum Ratings** (Note 1)

If Military/Aerospace specified devices are required, please contact the National Semiconductor Sales Office/Distributors for availability and specifications.

Supply Voltage ( $V_{CC}$ )  $\pm 7V$

$I_{OUT}$   
Output is short circuit protected to ground, but maximum reliability will be maintained if  $I_{OUT}$  does not exceed...

60mA

Common Mode Input Voltage  $\pm V_{CC}$

Differential Input Voltage  $\pm 10V$

Maximum Junction Temperature  $+150^{\circ}C$

Operating Temperature Range  $-40^{\circ}C$  to  $+85^{\circ}C$

Storage Temperature Range  $-65^{\circ}C$  to  $+150^{\circ}C$

Lead Temperature (Soldering 10 sec)  $+300^{\circ}C$

ESD Rating (Human Body Model)  $<1000V$

**Operating Ratings**

Thermal Resistance

Package ( $\theta_{JC}$ ) ( $\theta_{JA}$ )

MDIP  $55^{\circ}C/W$   $105^{\circ}C/W$

SOIC  $45^{\circ}C/W$   $115^{\circ}C/W$

**Electrical Characteristics**

( $A_V = +6$ ,  $V_{CC} = \pm 5V$ ,  $R_L = 100\Omega$ ,  $R_f = 500\Omega$ ; Unless Specified)

Symbol	Parameter	Conditions	Typ	Max/Min (Note 2)			Units
Ambient Temperature		CLC415AJ	$+25^{\circ}C$	$+25^{\circ}C$	$-40^{\circ}C$	$+85^{\circ}C$	
<b>Frequency Domain Response</b>							
SSBW	-3dB Bandwidth	$V_{OUT} < 2V_{PP}$	160	$>120$	$>120$	$>90$	MHz
LSBW		$V_{OUT} < 5V_{PP}$	120	$>85$	$>90$	$>80$	MHz
	Gain Flatness	$V_{OUT} < 2V_{PP}$					
GFPL	Peaking	DC to 25MHz	0	$<0.2$	$<0.2$	$<0.2$	dB
GFPH	Peaking	$>25MHz$	0	$<0.5$	$<0.5$	$<0.5$	dB
GFR	Rolloff	DC to 50MHz	0.2	$<0.7$	$<0.7$	$<1.1$	dB
LPD	Linear Phase Deviation	DC to 75MHz	0.5	$<1.0$	$<1.0$	$<1.3$	deg
DG1	Differential Gain ( $A_V = +2$ )	150 $\Omega$ Load, 3.58MHz	0.03	$<0.08$	$<0.08$	$<0.08$	%
DG2		150 $\Omega$ Load, 4.43MHz	0.03	$<0.10$	$<0.10$	$<0.10$	%
DP1	Differential Phase ( $A_V = +2$ )	150 $\Omega$ Load, 3.58MHz	0.03	$<0.08$	$<0.08$	$<0.08$	deg
DP2		150 $\Omega$ Load, 4.43MHz	0.03	$<0.10$	$<0.10$	$<0.10$	deg
XT	Crosstalk Input Referred	5MHz (All Hostile)	65	$<60$	$<60$	$<59$	dB
CXT	Crosstalk Input Referred	5MHz (Chan. to Chan.)	70	$<63$	$<63$	$<62$	dB
<b>Time Domain Response</b>							
TRS	Rise and Fall Time	2V Step	2.0	$<3.0$	$<3.0$	$<4.0$	ns
TRL		5V Step	3.0	$<4.0$	$<3.6$	$<4.5$	ns
TS	Settling Time to 0.1%	2V Step	12	$<18$	$<18$	$<22$	ns
OS	Overshoot	2V Step	8	$<12$	$<12$	$<12$	%
SR	Slew Rate		1500	$>1200$	$>1200$	$>1000$	V/ $\mu s$
<b>Distortion And Noise Response</b>							
HD2	2nd harmonic distortion	$2V_{PP}$ , 20MHz	-44	$<-38$	$<-38$	$<-34$	dBc
HD3	3rd harmonic distortion	$2V_{PP}$ , 20MHz	-54	$<-46$	$<-46$	$<-42$	dBc
	Equivalent Input Noise						
VN	Non-Inverting Voltage	$>1MHz$	3.0	$<3.6$	$<3.6$	$<4.0$	$nV/\sqrt{Hz}$
ICN	Inverting Current	$>1MHz$	11.5	$<14$	$<14$	$<16$	$pA/\sqrt{Hz}$
NCN	Non-Inverting Current	$>1MHz$	2.0	$<2.6$	$<2.6$	$<3.0$	$pA/\sqrt{Hz}$
SNF	Total Noise Floor	$>1MHz$	-157	$<-155$	$<-155$	$<-154$	dBm <sub>1Hz</sub>
INV	Total Integrated Noise	$>1MHz$ to 100MHz	37	$<44$	$<44$	$<48$	$\mu V$
<b>Static, DC Performance</b>							
VIO	Input Offset Voltage(Note 3)		2	$<9$	$<5$	$<10$	mV

**Electrical Characteristics** (Continued)(A<sub>V</sub> = +6, V<sub>CC</sub> = ±5V, R<sub>L</sub> = 100Ω, R<sub>f</sub> = 500Ω; Unless Specified)

Symbol	Parameter	Conditions	Typ	Max/Min (Note 2)			Units
<b>Static, DC Performance</b>							
DVIO	Average Temperature Coefficient		20	<50	-	<50	μV/°C
IBN	Input Bias Current (Note 3)	Non Inverting	5	<25	<13	<13	μA
DIBN	Average Temperature Coefficient		30	<150	-	<50	nA/°C
IBI	Input Bias Current (Note 3)	Inverting	3	<18	<10	<15	μA
DIBI	Average Temperature Coefficient		20	<100	-	<50	nA/°C
PSRR	Power Supply Rejection Ratio		55	>47	>47	>45	dB
CMRR	Common Mode Rejection Ratio		50	>45	>45	>43	dB
ICC	Supply Current, All Channels	No Load	20	<27	<26	<24	mA
<b>Miscellaneous Performance</b>							
RIN	Non-Inverting Input Resistance		1300	>300	>600	>600	kΩ
CIN	Non-Inverting Input Capacitance		1.0	<2.0	<2.0	<2.0	pF
RO	Output Impedance	DC	0.2	<0.6	<0.3	<0.2	Ω
VO	Output Voltage Range	R <sub>L</sub> = 100Ω	±2.6	±2.3	±2.5	±2.5	V
CMIR	Common Mode Input Range		±2.2	±1.4	±2.0	±2.0	V
IO	Output Current		60	50	50	50	mA

**Note 1:** "Absolute Maximum Ratings" are those values beyond which the safety of the device cannot be guaranteed. They are not meant to imply that the devices should be operated at these limits. The table of "Electrical Characteristics" specifies conditions of device operation.

**Note 2:** Max/min ratings are based on product characterization and simulation. Individual parameters are tested as noted. Outgoing quality levels are determined from tested parameters.

**Note 3:** AJ-level: spec. is 100% tested at +25°C.

**Typical Performance Characteristics** ( $T_A = 25^\circ$ ,  $A_V = +6$ ,  $V_{CC} = \pm 5V$ ,  $R_L = 100\Omega$ ,  $R_f = 500\Omega$ ; Unless Specified).

**Non-Inverting Frequency Response**

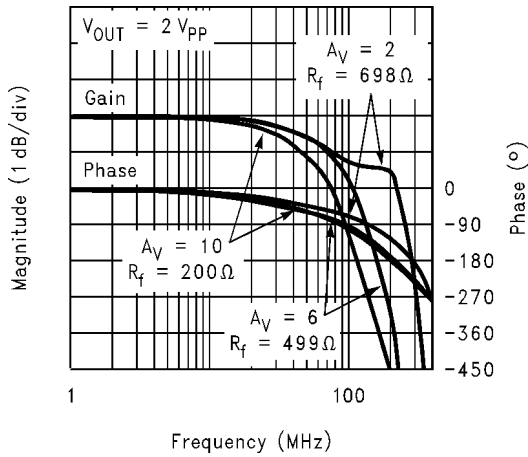

**Inverting Frequency Response**

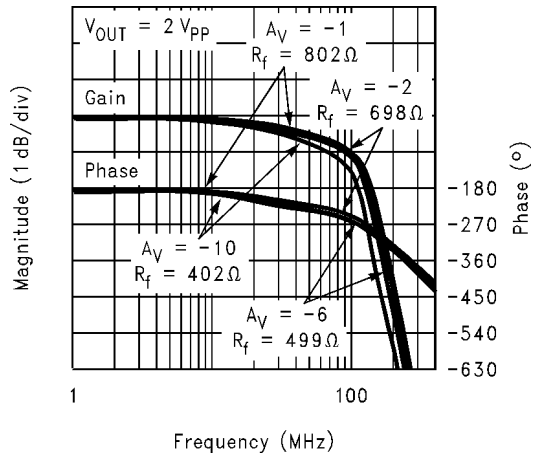

**Frequency Response for Various  $R_L$ S**

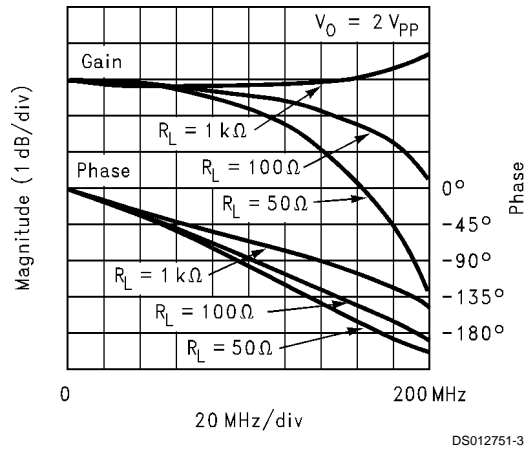

**Small Signal Pulse Response**

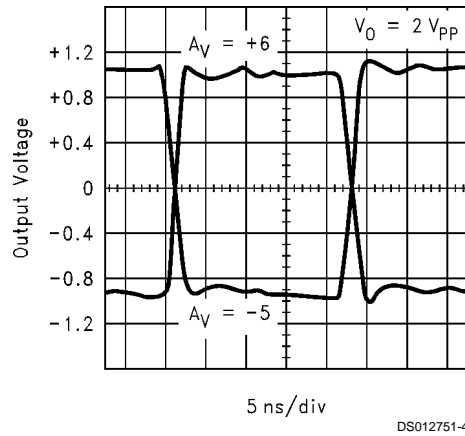

**Short-Term Settling Time**

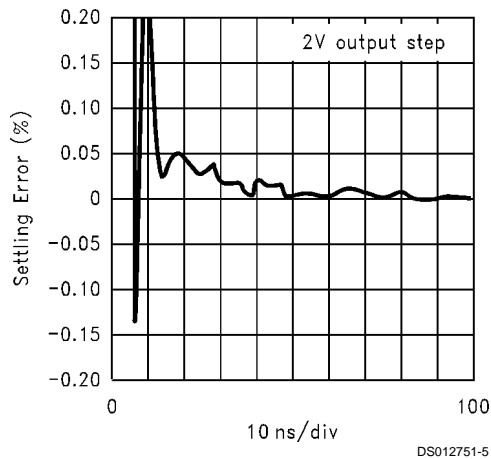

**Long-Term Settling Time**

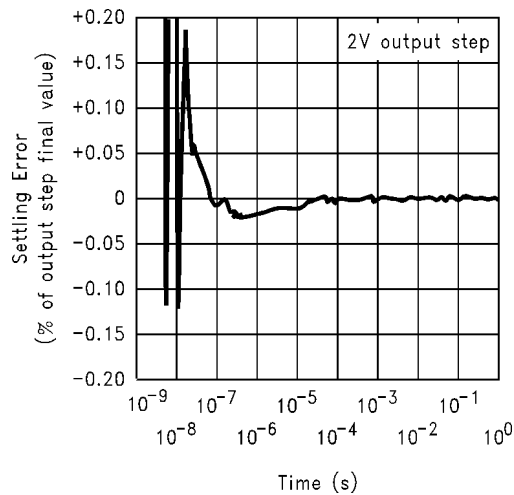

**Typical Performance Characteristics** (TA = 25°, AV = +6, VCC = ±5V, RL = 100Ω, Rf = 500Ω; Unless Specified). (Continued)

**2nd and 3rd Harmonic Distortion**

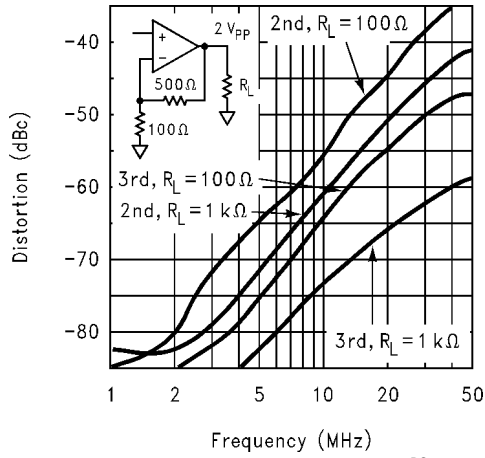

**2-Tone, 3rd Order, Spurious Levels**

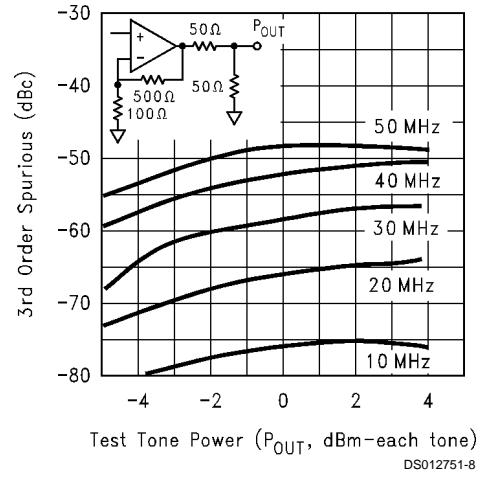

**Settling Time vs. Capacitive Load**

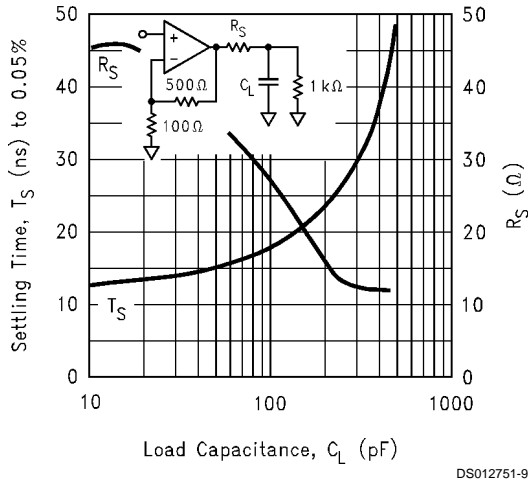

**All-Hostile Crosstalk Isolation**

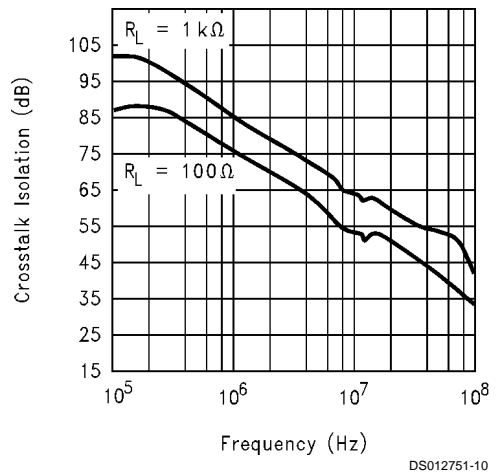

**Most Susceptible Channel-Channel Pulse Coupling**

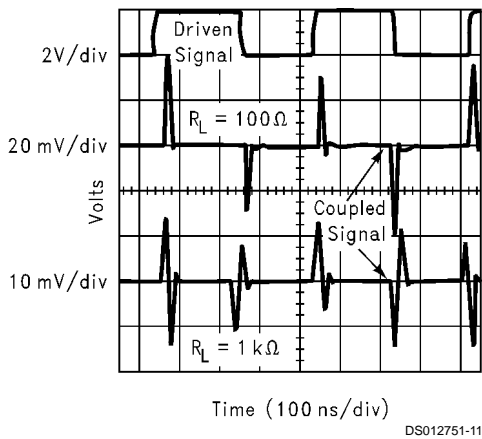

**Differential Gain and Phase (4.43 MHz, AV = +2)**

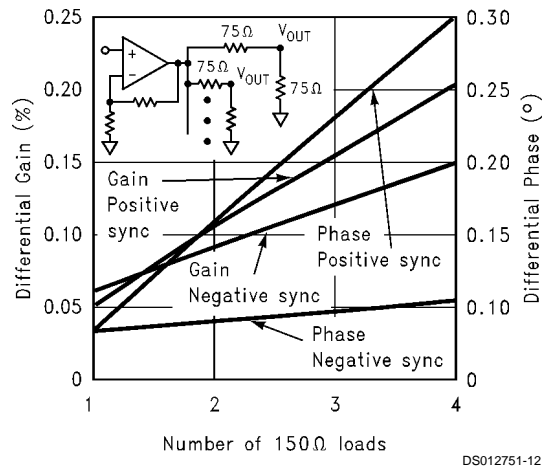

**Typical Performance Characteristics** (TA = 25°, AV = +6, VCC = ±5V, RL = 100Ω, Rf = 500Ω; Unless Specified). (Continued)

**Equivalent Input Noise**

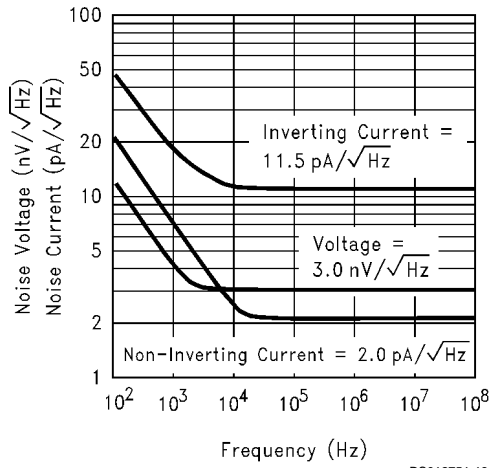

DS012751-13

**Open-Loop Transimpedance Gain, Z(s)**

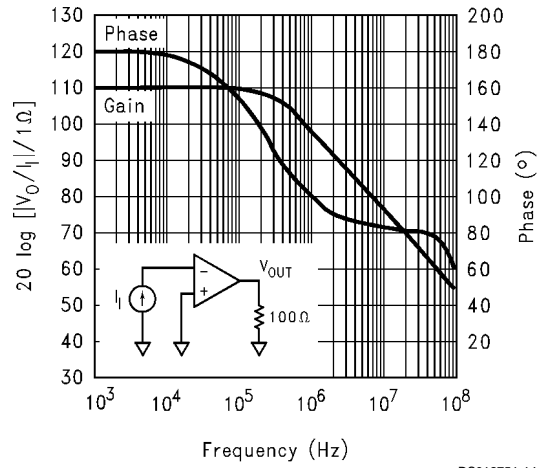

DS012751-14

**PSRR, CMRR, and Closed Loop R<sub>O</sub>**

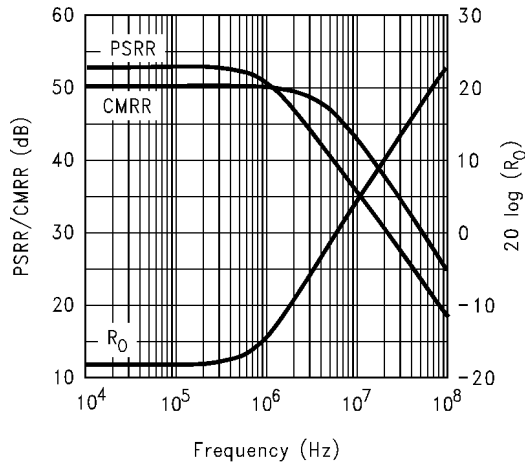

DS012751-15

## Application Division

### Feedback Resistor

The CLC415 achieves its exceptional AC performance while requiring very low quiescent power by using the current feedback topology and an internal slew rate enhancement circuit. The loop gain and frequency response for a current feedback op amp is predominantly set by the feedback resistor value. The CLC415 is optimized for a gain of +6 to use a 500Ω feedback resistor (**use a 900Ω R<sub>f</sub> for maximally flat response at a gain of +2**). Using lower values can lead to excessive ringing in the pulse response while higher value will limit the bandwidth.

Application Note OA-13 provides a more detailed discussion of choosing a feedback resistor. The equations found in this application note are to be considered a starting point for the determination of R<sub>f</sub> at any gain. The value of input impedance for the CLC415 is approximately 60Ω. These equations do not account for parasitic capacitance at the inverting input nor across R<sub>f</sub>. The plot found below entitled "Recommended R<sub>f</sub> vs. Gain" offers values of R<sub>f</sub> which will optimize the frequency response of the CLC415 over its ±1 to ±10 gain range. Unlike voltage feedback, current feedback op amps require a non-zero R<sub>f</sub> for unity gain followers.

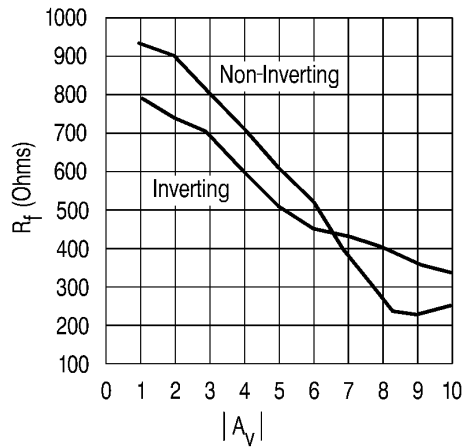

DS012751-19

FIGURE 1. Recommended R<sub>f</sub> vs. Gain

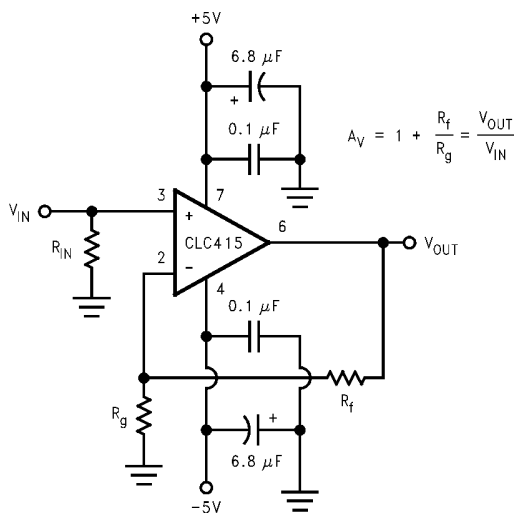

DS012751-16

FIGURE 2. Recommended Non-Inverting Gain Circuit

### Non-Inverting Source Impedance

For best operation, the DC source impedance looking out of the non-inverting input should be less than 3kΩ but greater than 20Ω. Parasitic self oscillations may occur in the input transistors if the DC source impedance is out of this range. This impedance also acts as the gain for the non-inverting input bias and noise currents and therefore can become troublesome for high values of DC source impedance. The inverting configuration of Figure 3 shows a 25Ω resistor to ground on the non-inverting input which insures stability but does not provide bias current cancellation. The input bias currents are unrelated for a current feedback amplifier which eliminates the need for source impedance matching to achieve bias current cancellation.

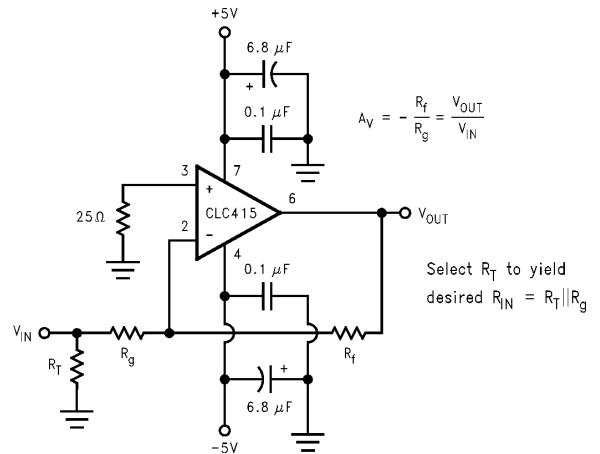

DS012751-17

FIGURE 3. Recommended Inverting Gain Circuit

### DC Accuracy and Noise

Please refer to the application information section of the CLC406 for a discussion of output offset voltage and spot noise calculation.

### Crosstalk

In any multi-channel integrated circuit there is an undesirable tendency for the signal in one channel to couple with and reproduce itself in the output of another channel. This effect is referred to as crosstalk. Crosstalk is expressed as channel separation or channel isolation which indicates the magnitude of this undesirable effect. This effect is measured by driving one or more channels and observing the output of the other undriven channel(s). The CLC415 plot page offers two different graphs detailing the effect of crosstalk over frequency. One plot entitled "All-Hostile Crosstalk Isolation" graphs all-hostile, input referred crosstalk. All-hostile crosstalk refers to the condition where three channels are driven simultaneously while observing the output of the undriven fourth channel. Input-referred implies that crosstalk is directly affected by gain and therefore a higher gain increases the crosstalk effect by a factor equal to that gain setting. The plot entitled "Most Susceptible Channel-to-Channel Pulse Coupling" describes the effect of crosstalk when one channel is driven with a 2V<sub>PP</sub> pulse while the output of the most effected channel is observed.



## Application Division (Continued)

### Unused Amplifiers

It is recommended that any unused amplifiers in the quad package be connected as unity gain followers ( $R_f=500\Omega$ ) with the non-inverting input tied to ground through a  $50\Omega$  resistor.

### Slew Rate and Harmonic Distortion

Please see the application information for the CLC406.

### Differential Gain and Phase

Differential gain and phase performance specifications are common to composite video distribution applications. These specifications refer to the change in small signal gain and phase of the color subcarrier frequency (4.43MHz for PAL composite video) as the amplifier output is swept over a range of DC voltages. Application Note OA-08 provides an additional discussion of differential gain and phase measurements.

### Printed Circuit Layout

As with any high speed component, a careful attention to the board layout is necessary for optimum performance. Of par-

ticular importance is the careful control of parasitic capacitances on the output pin. As the output impedance plot shows, the closed loop output for the CLC415 eventually becomes inductive as the loop gain rolls off with increasing frequency. Direct capacitive loading on the output pin can quickly lead to peaking in the frequency response, overshoot in the pulse response, ringing or even sustained oscillations. The "Settling Time vs. Capacitive Load" plot should be used as a starting point for the selection of a series output resistor when a capacitive load must be driven. A quad amplifier will require careful attention to signal routing in order to minimize the effects of crosstalk. Signal coupling through the power supplies can be reduced with bypass capacitors placed close to the device supply pins.

### Evaluation Board

Evaluation PC boards (part number CLC730024 for through-hole and 730031 for SOIC) for the CLC415 are available.

**Physical Dimensions** inches (millimeters) unless otherwise noted

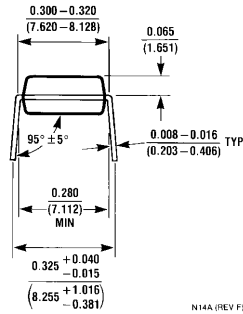
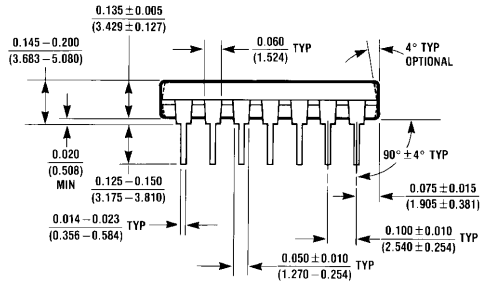
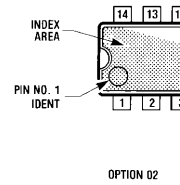
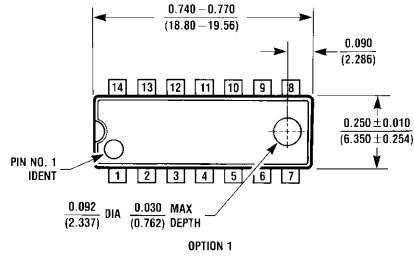

N14A (REV F)

**14-Pin MDIP  
NS Package Number N14A**

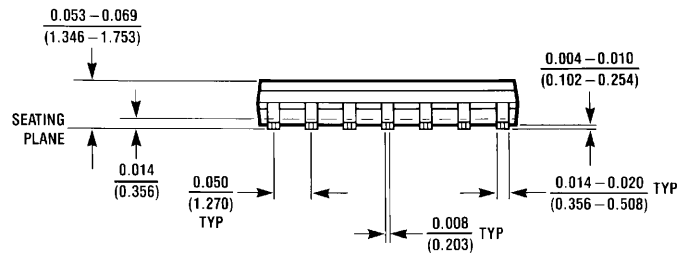
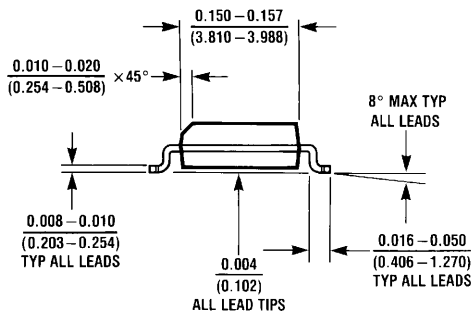
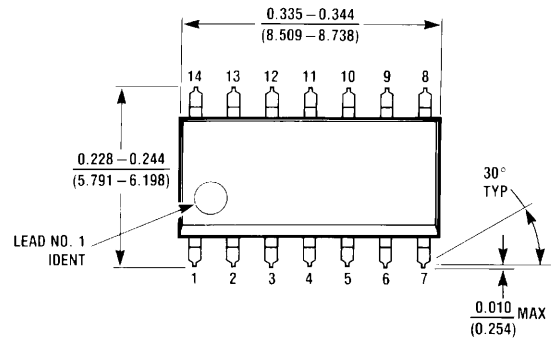

M14A (REV H)

**14-Pin SOIC  
NS Package Number M14A**

## Notes

### LIFE SUPPORT POLICY

NATIONAL'S PRODUCTS ARE NOT AUTHORIZED FOR USE AS CRITICAL COMPONENTS IN LIFE SUPPORT DEVICES OR SYSTEMS WITHOUT THE EXPRESS WRITTEN APPROVAL OF THE PRESIDENT AND GENERAL COUNSEL OF NATIONAL SEMICONDUCTOR CORPORATION. As used herein:

1. Life support devices or systems are devices or systems which, (a) are intended for surgical implant into the body, or (b) support or sustain life, and whose failure to perform when properly used in accordance with instructions for use provided in the labeling, can be reasonably expected to result in a significant injury to the user.
2. A critical component is any component of a life support device or system whose failure to perform can be reasonably expected to cause the failure of the life support device or system, or to affect its safety or effectiveness.



**National Semiconductor Corporation**  
Americas  
Email: support@nsc.com

[www.national.com](http://www.national.com)

**National Semiconductor Europe**

Fax: +49 (0) 180-530 85 86  
Email: europe.support@nsc.com  
Deutsch Tel: +49 (0) 69 9508 6208  
English Tel: +44 (0) 870 24 0 2171  
Français Tel: +33 (0) 1 41 91 8790

**National Semiconductor Asia Pacific Customer Response Group**

Tel: 65-2544466  
Fax: 65-2504466  
Email: ap.support@nsc.com

**National Semiconductor Japan Ltd.**

Tel: 81-3-5639-7560  
Fax: 81-3-5639-7507

[Products](#) > [Analog - Amplifiers](#) > [Operational Amplifiers](#) > [Legacy High Speed](#) > CLC415

# CLC415 Product Folder

## Quad, Wideband Monolithic Op Amp

See Also: [LMH6644](#) - LOWER COST

[General Description](#)

[Features](#)

[Datasheet](#)

[Package & Models](#)

[Samples & Pricing](#)

[Design Tools](#)

[Application Notes](#)

### Parametric Table

Channels (Channels)	4
Input Output Type	Not Rail to Rail
Bandwidth, typ (MHz)	259
Slew Rate, typ (Volts/usec)	1500
Supply Current per Channel, typ (mA)	5
Minimum Supply Voltage (Volt)	10
Maximum Supply Voltage (Volt)	14
Offset Voltage, Max (mV)	5
Input Bias Current, Temp Max (nA)	25000
Output Current, typ (mA)	70
Voltage Noise, typ (nV/Hz)	3
Shut down	No

### Parametric Table

Feedback Type	Current
BW at Av+ 1 (MHz)	260
BW at Av+ 2 (MHz)	240
BW at Av+ 5 (MHz)	170
BW at Av+ 10 (MHz)	101
BW at Av+ 20 (MHz)	-
HD 2nd, typ (dB)	-44
HD 3rd, typ (dB)	-54
DG, typ (dB)	.03
DP, typ (%)	.03
Settling Time	12nS to 0.1 %
Special Features	-

### Datasheet

Title	Size in Kbytes	Date	<input type="checkbox"/> View Online	<input type="checkbox"/> Download	<input type="checkbox"/> Receive via Email
CLC415 Quad, Wideband Monolithic Op Amp	279 Kbytes	7-Dec-01	<a href="#">View Online</a>	<a href="#">Download</a>	<a href="#">Receive via Email</a>
CLC415 Quad, Wideband Monolithic Op Amp (JAPANESE)	386 Kbytes		<input type="checkbox"/> View Online	<input type="checkbox"/> Download	<input type="checkbox"/> Receive via Email
CLC415 Mil-Aero Datasheet MNCLC415A-X	89 Kbytes		<a href="#">View Online</a>	<a href="#">Download</a>	<a href="#">Receive via Email</a>

If you have trouble printing or viewing PDF file(s), see [Printing Problems](#).

## Package Availability, Models, Samples & Pricing

Part Number	Package			Status	Models		Samples & Electronic Orders	Budgetary Pricing		Std Pack Size	<a href="#">Package Marking</a>
	Type	Pins	MSL		SPICE	IBIS		Qty	\$US each		
CLC415AJE	<a href="#">SOIC NARROW</a>	14	<a href="#">MSL</a>	Lifetime buy	<a href="#">clc415.cir</a>	N/A		1K+	\$5.0500	rail of 55	[logo]UçZç2çT CLC415AJE
CLC415AJE-TR13	<a href="#">SOIC NARROW</a>	14	<a href="#">MSL</a>	Lifetime buy	<a href="#">clc415.cir</a>	N/A		1K+	\$5.0500	reel of 2500	[logo]UçZç2çT CLC415AJE
CLC415AJ-MPR	<a href="#">CERDIP</a>	14	<a href="#">MSL</a>	Preliminary	<a href="#">clc415.cir</a>	N/A				rail of N/A	[logo]çZçSç4çAçE CLC415AJ-MPR PROTO
5962-9305501MCA	<a href="#">CERDIP</a>	14	<a href="#">MSL</a>	Full production	<a href="#">clc415.cir</a>	N/A	<b>Buy Now</b>	25+	\$42.5000	rail of 25	[logo]çZçSç4çAçE CLC415AJ-QML 5962-9305501MCA

## General Description

The CLC415 is a wideband, quad, monolithic operational amplifier designed for intermediate gain applications where power and cost per channel are primary concern. Benefiting from National's current feedback architecture, the CLC415 offers a gain range of  $\pm 1$  to  $\pm 10$  while providing stable, oscillation free operation without external compensation, even at unity gain.

Operating from  $\pm 5V$  supplies, the CLC415 consumes only 50mW of power per channel, yet maintains a 160MHz small-signal bandwidth and a 1500V/ $\mu$ s slew rate. High density applications requiring an integrated solution will enjoy the CLC415's 70dB channel isolation (input referred @ 5MHz).

With its exceptional differential gain and phase, typically 0.03% and  $0.03^\circ$  @ 3.58MHz, the CLC415 is designed to meet the performance and cost per channel requirements of high volume composite video applications. The CLC415's large-signal bandwidth, high slew rate and high drive capability are features well suited for RGB-video applications.

The CLC415 is a quad version of the high speed CLC406 while the CLC414 is a lower power quad version of the same. Both of these quads afford the designer lower power consumption and lower cost per channel with the additional benefit of requiring less board space per amplifier.

Constructed using an advanced, complementary bipolar process and National's proven current feedback architectures. The CLC415 is available in several versions to meet a variety of requirements.

### Enhanced Solutions (Military/ Aerospace)

SMD Number: 5962-93055

Space level versions also available.

For more information, visit <http://www.national.com/mil>

## Features

- 160MHz small signal bandwidth
- 5mA quiescent current per amplifier
- 70dB channel isolation @ 5MHz
- 0.03%/0.03° differential gain/phase
- 12ns settling to 0.1%
- 1500V/ $\mu$ s slew rate
- 2.0ns rise and fall time (2V<sub>pp</sub>)
- 60mA output current per amplifier

## Applications

- Composite video distribution amps
- HDTV amplifiers
- RGB-video amplifiers
- CCD signal processing
- Active Filters
- Instrumentation differential amps
- Channelized EW

## Design Tools

Title	Size in Kbytes	Date	<input type="checkbox"/>	<input type="checkbox"/>	<input type="checkbox"/>
			<a href="#">View Online</a>	<a href="#">Download</a>	<a href="#">Receive via Email</a>
Amplifiers Selection Guide software for Windows	7 Kbytes	12-Jun-2002	<a href="#">View</a>		
CLC730024EB 14 pin DIP Op Amp Evaluation Board	85 Kbytes	27-Oct-1998	<a href="#">View Online</a>	<a href="#">Download</a>	<a href="#">Receive via Email</a>
CLC730031EB 14 pin SOIC Op Amp Evaluation Board	85 Kbytes	27-Oct-1998	<a href="#">View Online</a>	<a href="#">Download</a>	<a href="#">Receive via Email</a>

If you have trouble printing or viewing PDF file(s), see [Printing Problems](#).

## Application Notes

Title	Size in Kbytes	Date	<input type="checkbox"/>	<input type="checkbox"/>	<input type="checkbox"/>
			<a href="#">View Online</a>	<a href="#">Download</a>	<a href="#">Receive via Email</a>
OA-07: OA-07 Current- Feedback Op Amp Applications Circuit Guide	308 Kbytes	28-Oct-96	<a href="#">View Online</a>	<a href="#">Download</a>	<a href="#">Receive via Email</a>
OA-11: OA-11 A Tutorial on Applying Op Amps to RF Applications	769 Kbytes	2-Apr-99	<a href="#">View Online</a>	<a href="#">Download</a>	<a href="#">Receive via Email</a>
OA-12: OA-12 Noise Analysis for Comlinear's Op Amps	108 Kbytes	24-Feb-99	<a href="#">View Online</a>	<a href="#">Download</a>	<a href="#">Receive via Email</a>
OA-13: OA-13 Current- Feedback Loop Gain Analysis	527 Kbytes	28-Oct-96	<a href="#">View Online</a>	<a href="#">Download</a>	<a href="#">Receive via Email</a>
OA-14: OA-14 Improving Amplifier Noise Figure for High 3rd Intercept Amplifiers	92 Kbytes	15-Dec-00	<a href="#">View Online</a>	<a href="#">Download</a>	<a href="#">Receive via Email</a>

OA-15: OA-15 Frequent Faux Pas in Applying Wideband Current Feedback Amplifiers	527 Kbytes	28-Jan-99	<a href="#">View Online</a>	<a href="#">Download</a>	<a href="#">Receive via Email</a>
OA-18: OA-18 Simulation SPICE Models for Comlinear's Op Amps	337 Kbytes	23-May-00	<a href="#">View Online</a>	<a href="#">Download</a>	<a href="#">Receive via Email</a>
OA-20: OA-20 Current Feedback Myths Debunked	139 Kbytes	10-Jul-97	<a href="#">View Online</a>	<a href="#">Download</a>	<a href="#">Receive via Email</a>
OA-25: OA-25 Stability Analysis of Current Feedback Amplifier	262 Kbytes	10-Oct-96	<a href="#">View Online</a>	<a href="#">Download</a>	<a href="#">Receive via Email</a>
OA-30: OA-30 Current vs. Voltage Feedback Amplifiers	56 Kbytes	5-Jun-98	<a href="#">View Online</a>	<a href="#">Download</a>	<a href="#">Receive via Email</a>

If you have trouble printing or viewing PDF file(s), see [Printing Problems](#).

[Information as of 5-Aug-2002]

---

Search [Design](#) [Purchasing](#) [Quality](#) [Company](#) [Home](#)

---

[About Languages](#) . [Website Guide](#) . [About "Cookies"](#) . National is [QS 9000 Certified](#) . [Privacy/Security Statement](#) . [Contact Us](#) . [Site Terms & Conditions of Use](#) . Copyright 2002 © National Semiconductor Corporation . [My Preferences](#) . [Feedback](#)