



SUCCESSIVE DETECTION LOG VIDEO AMPLIFIER (SDLVA) WITH LIMITED RF OUTPUT, 1 - 20 GHz

Typical Applications

The HMC813LC4B is ideal for:

- EW, ELINT & IFM Receivers
- DF Radar Systems
- ECM Systems
- Broadband Test & Measurement
- Power Measurement & Control Circuits
- Military & Space Applications

Features

- High Logging Range: 55 dB
- Frequency Flatness: ± 1.5 dB
- Saturated Output Power: -7 dBm
- Fast Rise/Fall Times: 5/10 ns
- Single Positive Supply: +3.3V
- ESD Sensitivity (HBM): Class 1A
- 24 Lead 4x4 mm SMT Package: 16 mm²

Functional Diagram

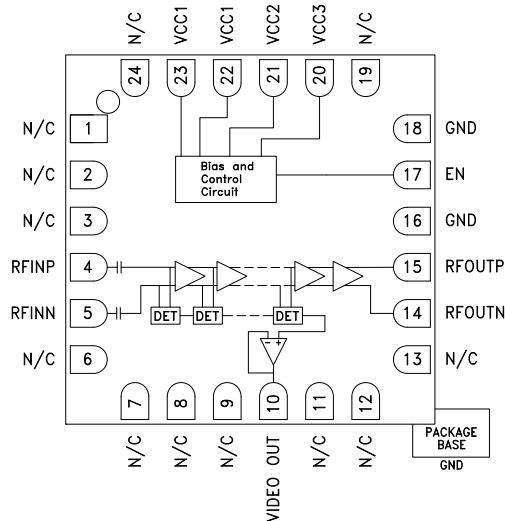

General Description

The HMC813LC4B is a Successive Detection Log Video Amplifier (SDLVA) with a limited RF output which operates from 1 to 20 GHz. The HMC813LC4B provides a logging range of 55 dB. This device offers typical fast rise/fall times of 5/10 ns. The HMC813LC4B log video output slope is typically 15 mV/dB. Maximum recovery times are less than 15 ns. Ideal for high speed channelized receiver applications, the HMC813LC4B operates from a single +3.3 V supply, and consumes only 153 mA. The HMC813LC4B is available in a highly compact 4x4 mm SMT ceramic package and is ideal for high speed channelized receiver applications.

Electrical Specifications, $T_A = +25^\circ\text{C}$, $V_{cc1} = V_{cc2} = V_{cc3} = 3.3\text{V}$ [1]

| Parameter | Conditions | Typ. | Units |
|--------------------------------------|------------------------------|-----------|-------|
| Input Frequency Range ^[2] | | 1 - 20 | GHz |
| Frequency Flatness (Video out) | Pin= -25 dBm | ± 1.5 | dB |
| Log Linearity | Pin= -40 dBm to +0 dBm | ± 1 | dB |
| Log Linearity over Temperature | -55 to +85° C, Pin= -20 dBm | ± 0.5 | dB |
| Minimum Logging Range | to ± 3 dB error @ 18 GHz | -53 | dBm |
| Maximum Logging Range | to ± 3 dB error @ 18 GHz | 7 | dBm |
| Saturated Output Power, Psat | | -7 | dBm |
| Saturated Output Power Flatness | | ± 1.5 | dB |
| RF Input Return Loss | | 8 | dB |
| RF Output Return Loss | | 18 | dB |
| Log Video Minimum Output Voltage | | 0.9 | V |
| Log Video Maximum Output Voltage | | 1.73 | V |
| Log Video Output Rise Time | Pin = 0 dBm, 10% to 90% | 5 | ns |
| Log Video Output Fall Time | Pin = 0 dBm, 90% to 10% | 10 | ns |

[1] Electrical specifications and performance plots are given for single-ended operation.

[2] Video output load should be 1K Ohm or higher.



SUCCESSIVE DETECTION LOG VIDEO AMPLIFIER (SDLVA) WITH LIMITED RF OUTPUT, 1 - 20 GHz

Electrical Specifications, (continued) [1]

| Parameter | Conditions | Typ. | Units |
|---|------------------|------|---------------------------------------|
| Log Video Recovery Time | -40 dBm to 0 dBm | 15 | ns |
| Log Video Output Slope | | 15 | mV/dB |
| Log Video Output Slope Variation over Temperature | @ 10 GHz | 10 | $\mu\text{V}/\text{dB}^\circ\text{C}$ |
| Log Video Propagation Delay | | 15 | ns |
| Supply Current (I _{dc}) | | 153 | mA |

[1] Electrical specifications and performance plots are given for single-ended operation

Error Flatness vs. Input Power Over Frequency [1]

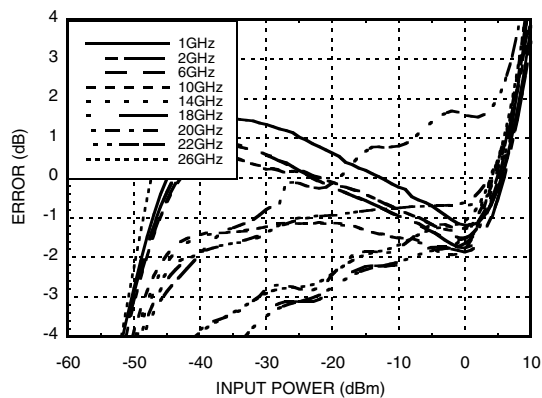

VIDEO OUT & Error vs. Input Power, Fin = 1 GHz [1]

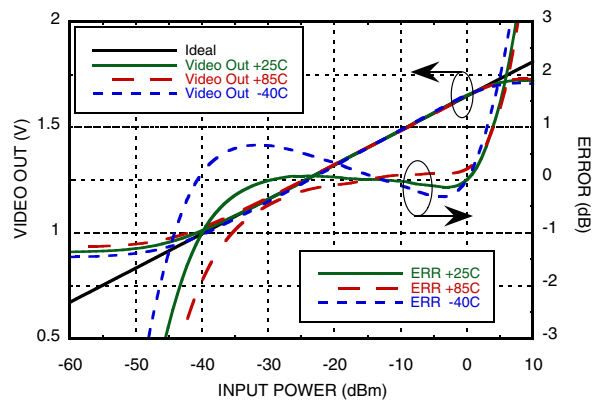

VIDEO OUT & Error vs. Input Power, Fin = 2 GHz [1]

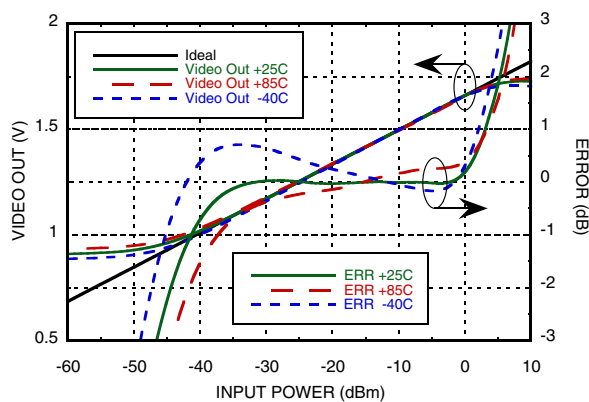

VIDEO OUT & Error vs. Input Power, Fin = 6 GHz [1]

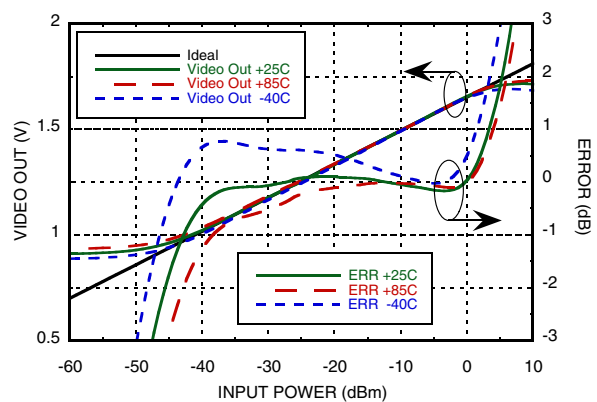

[1] Electrical specs and performance plots are given for single-ended operation



**SUCCESSIVE DETECTION LOG VIDEO AMPLIFIER (SDLVA)
WITH LIMITED RF OUTPUT, 1 - 20 GHz**

POWER DETECTORS - SMT

VIDEO OUT & Error vs. Input Power, $F_{in} = 10$ GHz ^[1]

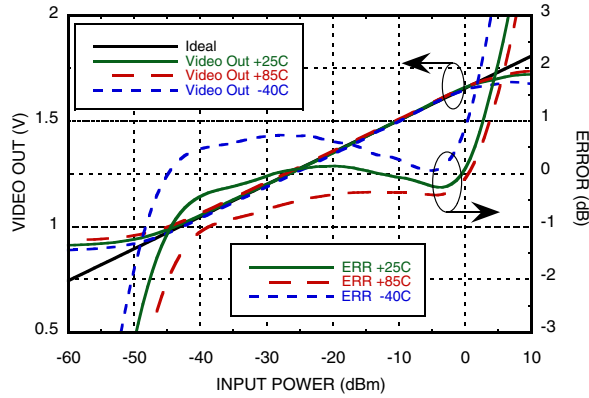

VIDEO OUT & Error vs. Input Power, $F_{in} = 14$ GHz ^[1]

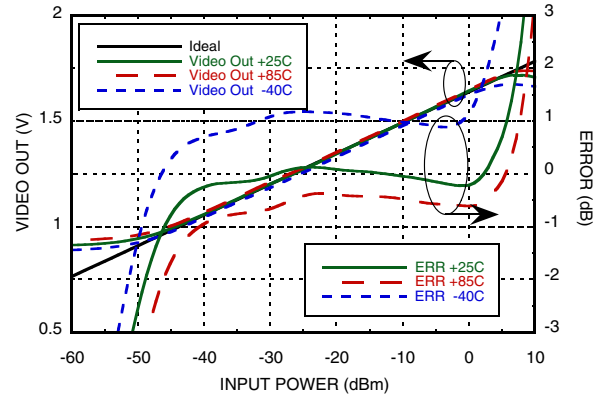

VIDEO OUT vs. Error vs. Input Power, $F_{in} = 18$ GHz ^[1]

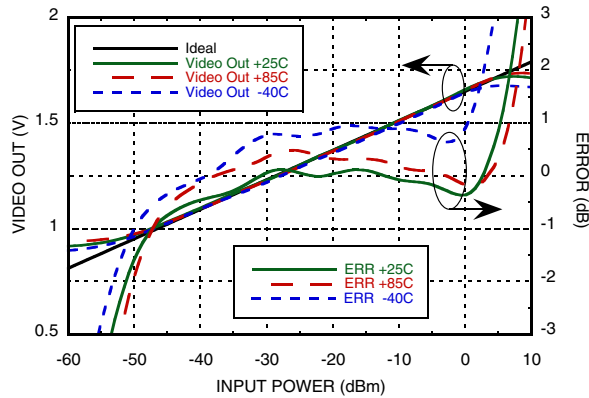

VIDEO OUT & Error vs. Input Power, $F_{in} = 20$ GHz ^[1]

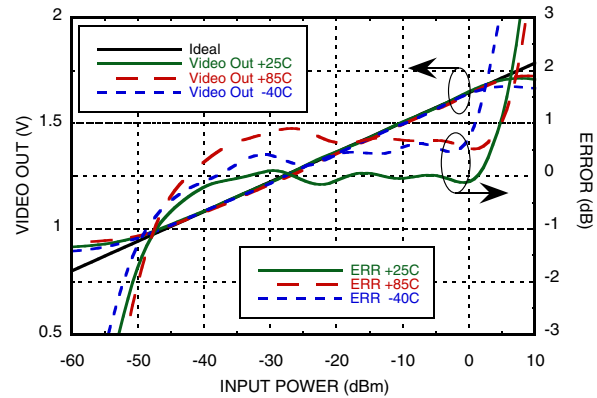

VIDEO OUT & Error vs. Input Power, $F_{in} = 22$ GHz ^[1]

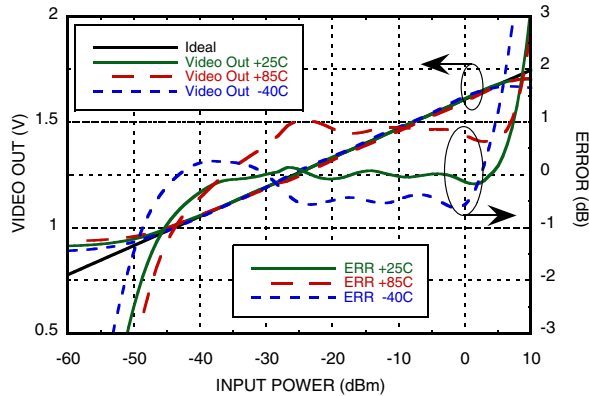

VIDEO OUT & Error vs. Input Power, $F_{in} = 26$ GHz ^[1]

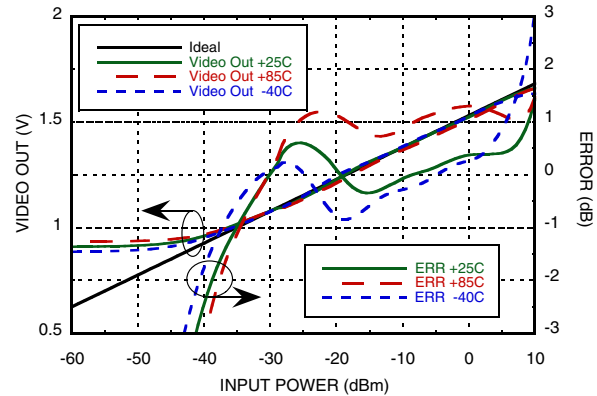

[1] Electrical specs and performance plots are given for single-ended operation



SUCCESSIVE DETECTION LOG VIDEO AMPLIFIER (SDLVA) WITH LIMITED RF OUTPUT, 1 - 20 GHz

**VIDEO OUT vs. Frequency
Over Input Power & Temperature [1]**

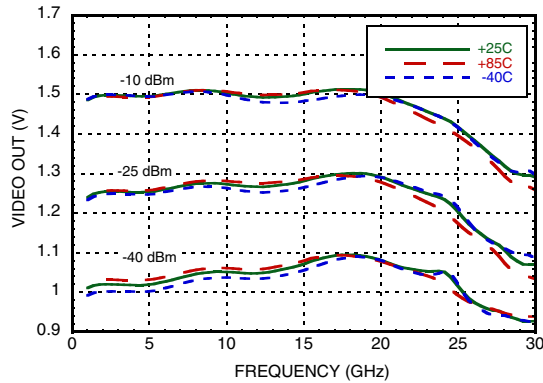

**Saturated RF Output Power vs. Frequency
Over Temperature @ Pin = -10 dBm [1]**

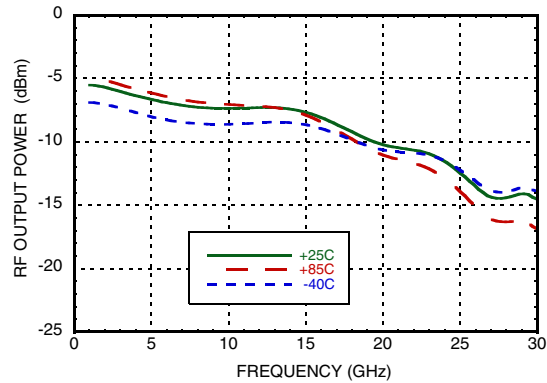

**RF Output Power vs. Input Power
Over Frequency [1]**

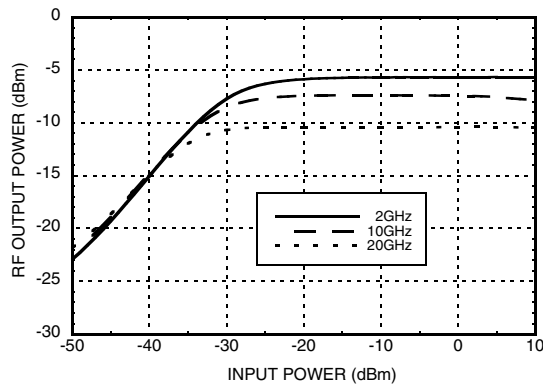

**Phase Linearity over Frequency @ 25 C
Temperature [1]**

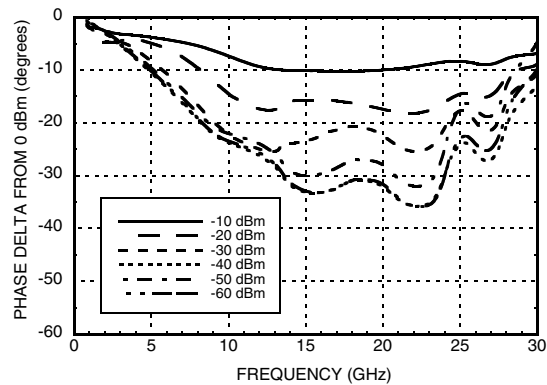

**Phase Linearity over Frequency @ 85 C
Temperature [1]**

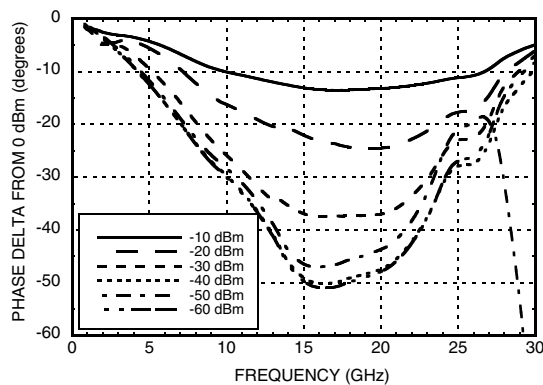

**Phase Linearity over Frequency @ -40 C
Temperature [1]**

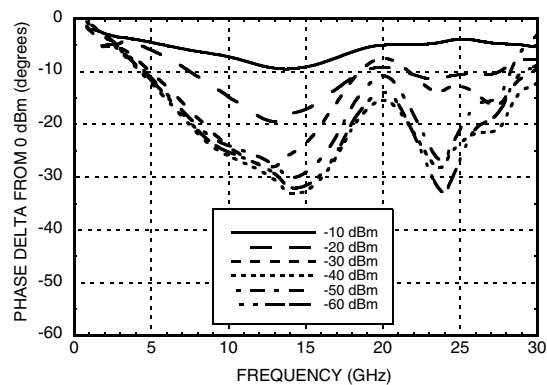

[1] Electrical specs and performance plots are given for single-ended operation



SUCCESSIVE DETECTION LOG VIDEO AMPLIFIER (SDLVA) WITH LIMITED RF OUTPUT, 1 - 20 GHz

Rise Time for Various Frequencies

@ Pin = 0 dBm ^[1]

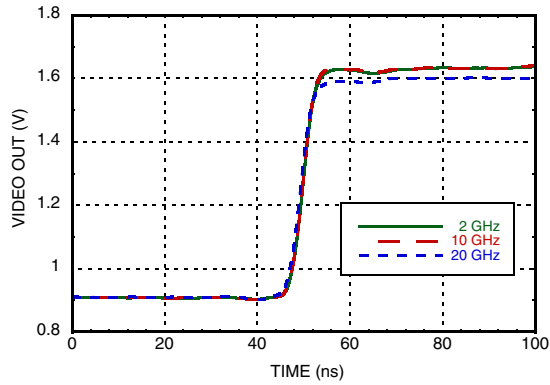

Fall Time for Various Frequencies

@ Pin = 0 dBm ^[1]

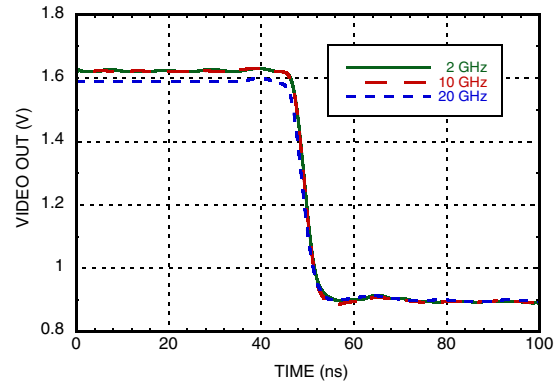

Return Loss vs. Frequency Over Temperature ^[1]

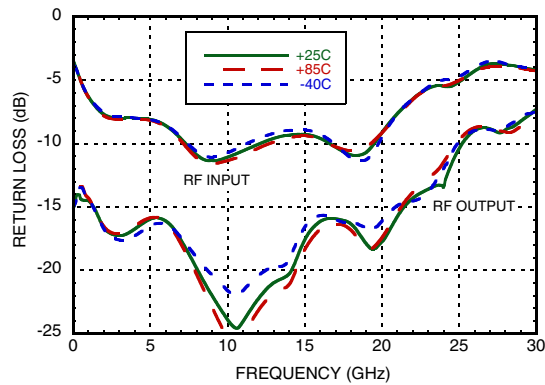

[1] Electrical specs and performance plots are given for single-ended operation



SUCCESSIVE DETECTION LOG VIDEO AMPLIFIER (SDLVA) WITH LIMITED RF OUTPUT, 1 - 20 GHz

Absolute Maximum Ratings

| | |
|--|----------------|
| Vcc1, Vcc2, Vcc3, Vcc4 | +3.6V |
| ENBL | +3.6V |
| RF Input Power | +15 dBm |
| Channel Temperature | 125 °C |
| Continuous P _{diss} (T=85°C) Derate 12.63 mW/°C above 85°C | 0.51 W |
| Thermal Resistance (Channel to die bottom) | 79.20 °C/W |
| Storage Temperature | -65 to +150 °C |
| Operating Temperature | -55 to +85 °C |
| ESD Sensitivity (HBM) | Class 1A |



**ELECTROSTATIC SENSITIVE DEVICE
OBSERVE HANDLING PRECAUTIONS**

Outline Drawing

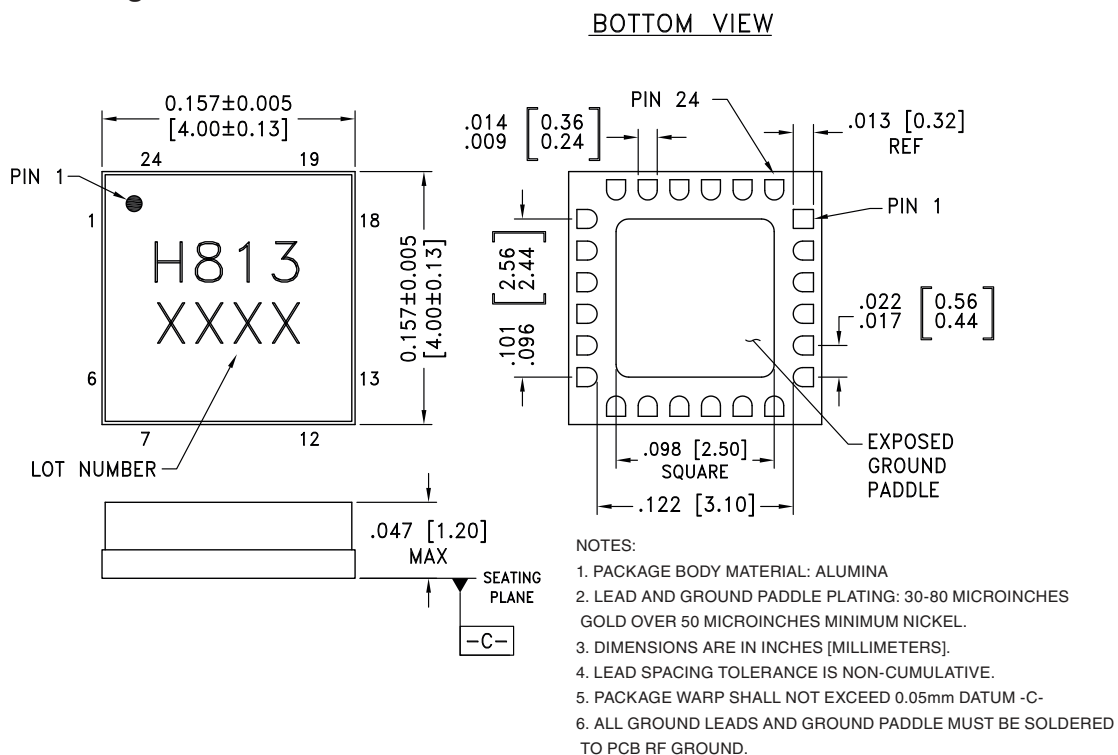

Package Information

| Part Number | Package Body Material | Lead Finish | MSL Rating | Package Marking ^[2] |
|-------------|-----------------------|------------------|---------------------|--------------------------------|
| HMC813LC4B | Alumina, White | Gold over Nickel | MSL3 ^[1] | H813 XXXX |



[1] Max peak reflow temperature of 260 °C

[2] 4-Digit lot number XXXX

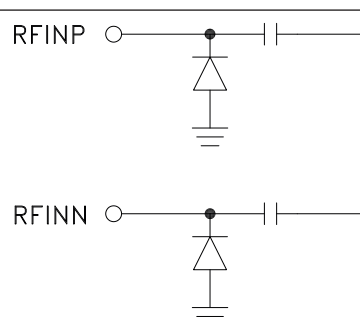
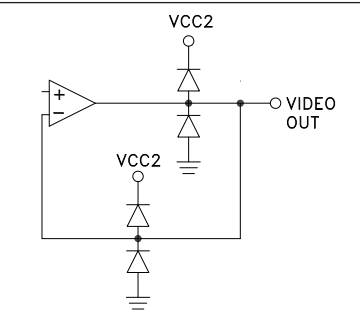
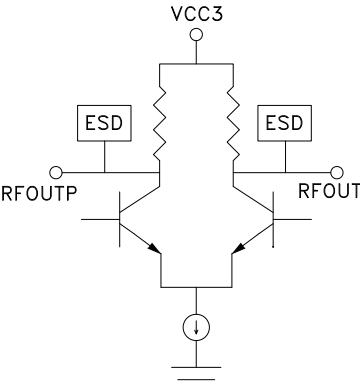

SUCCESSIVE DETECTION LOG VIDEO AMPLIFIER (SDLVA) WITH LIMITED RF OUTPUT, 1 - 20 GHz

Pin Descriptions

| Pin Number | Function | Description | Interface Schematic |
|-------------------------|----------------|--|---|
| 1-3, 6-9, 11-13, 19, 24 | N/C | The pins are not connected internally; however, all data shown herein was measured with these pins connected to RF/DC ground externally. | |
| 4, 5 | RFINP, RFINN | RF Input pins. Connect RF to RFINP, and AC couple RFINN to ground via 50 Ohm for single ended operation. |  |
| 10 | VIDEO OUT | Video out load should be at least 1K Ohm or higher. |  |
| 14, 15 | RFOUTN, RFOUTP | RF Output pins. Connect RF to RFOUTP, and AC couple RFOUTN to ground via 50 Ohm for single ended operation |  |
| 16, 18 | GND | These pins and the exposed package bottom must be connected to a high quality RF/DC ground. |  |



SUCCESSIVE DETECTION LOG VIDEO AMPLIFIER (SDLVA) WITH LIMITED RF OUTPUT, 1 - 20 GHz

Pad Descriptions (Continued)

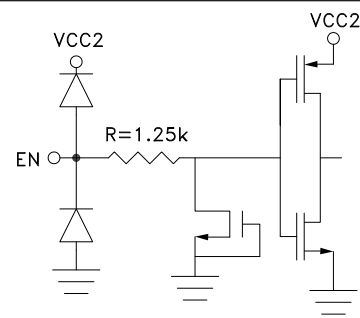
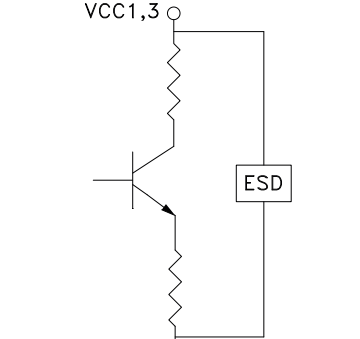
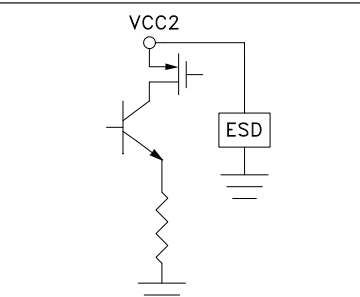
| Pin Number | Function | Description | Interface Schematic |
|------------|----------|--|---|
| 17 | EN | Enable pin, connected to supply voltage for normal operation. Total supply current reduced to less than 3mA when EN is set to 0V. |  |
| 20 | VCC3 | Bias supply. Connect supply voltage to these pins with appropriate filtering. See application circuit. To ensure proper start-up supply rise time should be faster than 100usec |  |
| 22, 23 | VCC1 | | |
| 21 | VCC2 | Bias supply. Connect supply voltage to this pin with appropriate filtering. See application circuit. To ensure proper start-up supply rise time should be faster than 100usec |  |



SUCCESSIVE DETECTION LOG VIDEO AMPLIFIER (SDLVA) WITH LIMITED RF OUTPUT, 1 - 20 GHz

Application Circuit

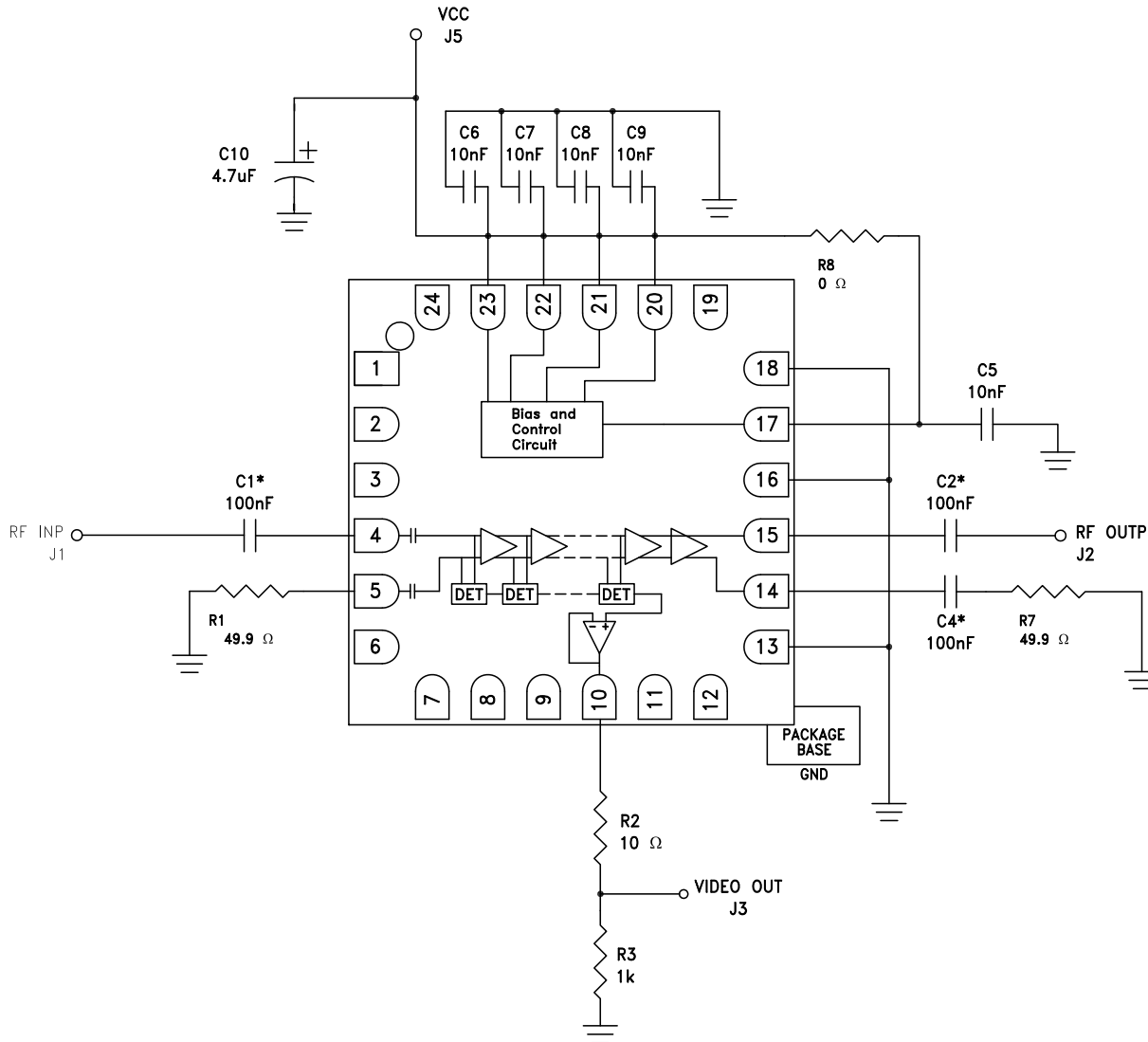

*C1, C2 and C4 are ultra-wideband capacitors.

Note: Video output load should be 1K Ohm or higher.



SUCCESSIVE DETECTION LOG VIDEO AMPLIFIER (SDLVA) WITH LIMITED RF OUTPUT, 1 - 20 GHz

Evaluation PCB

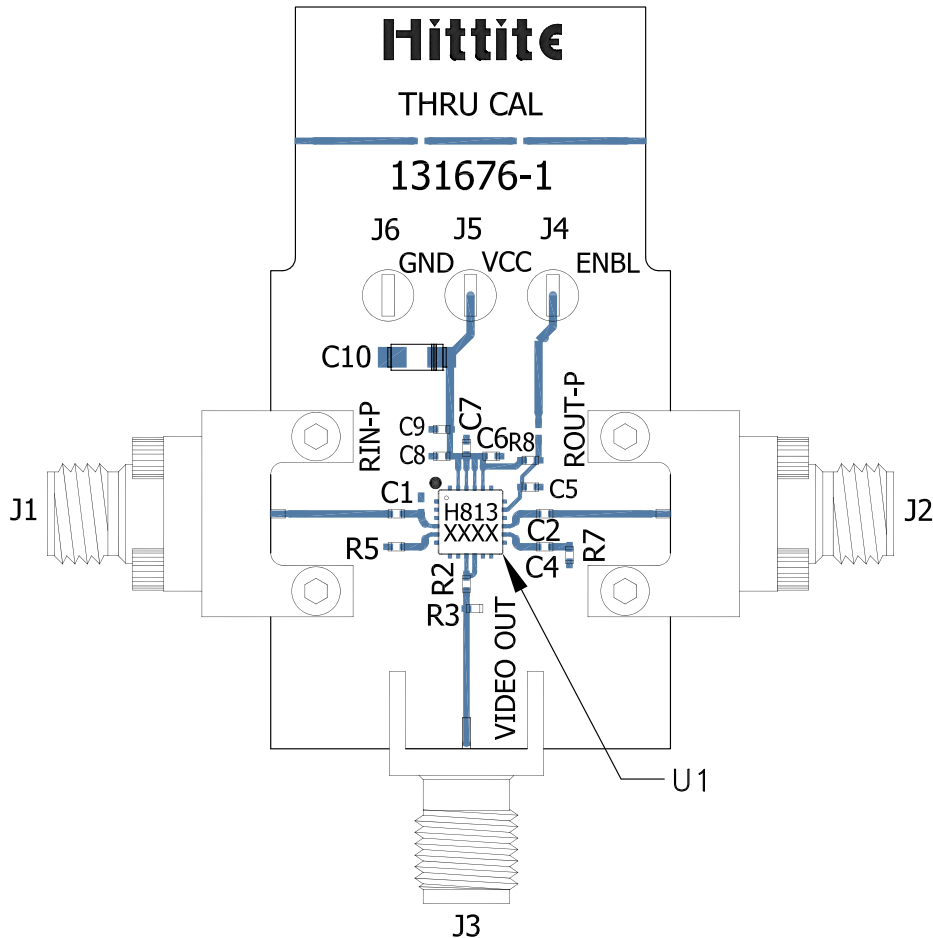

List of Materials for Evaluation PCB 131679 [1]

| Item | Description |
|------------|--|
| J1, J2 | K-Type Connector |
| J3 | SMA Connector |
| J4 - J6 | DC Pins |
| C1, C2, C4 | 100 nF Ultra-Wideband Capacitor, 0402 Pkg. ATC ATC545L104KW16T |
| C5 - C9 | 10 nF Capacitor, 0402 Pkg. |
| C10 | 4.7 μ F Tantalum Capacitor, CASE A Pkg. |
| R2 | 10 Ohm Resistor, 0402 Pkg. |
| R3 | 1k Ohm Resistor, 0402 Pkg. |
| R5, R7 | 49.9 Ohm Resistor, 0402 Pkg. |
| R8 | 0 Ohm Resistor, 0402 Pkg. |
| U1 | HMC813LC4B SDLVA |

[1] Reference this number when ordering complete evaluation PCB

[2] Circuit Board Material: Rogers 4350 or Arlon 25 FR

The circuit board used in the application should use RF circuit design techniques. Signal lines should have 50 ohm impedance while the package ground leads and exposed paddle should be connected directly to the ground plane similar to that shown. A sufficient number of via holes should be used to connect the top and bottom ground planes. The evaluation circuit board shown is available from Hittite upon request.