

THIS IS A C.A.D. GENERATED DRAWING
DO NOT MAKE MANUAL REVISIONS TO MASTER.

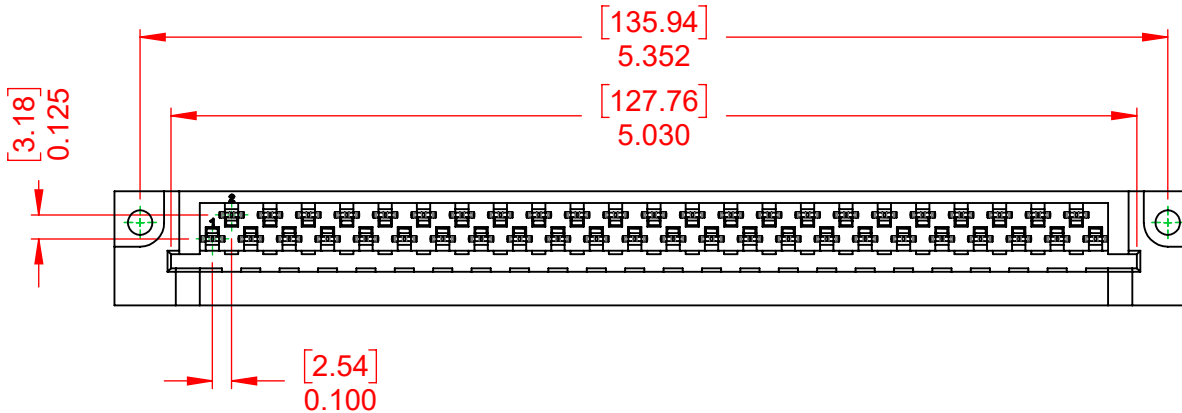

ISSUE NUMBER
ORIGINAL ①

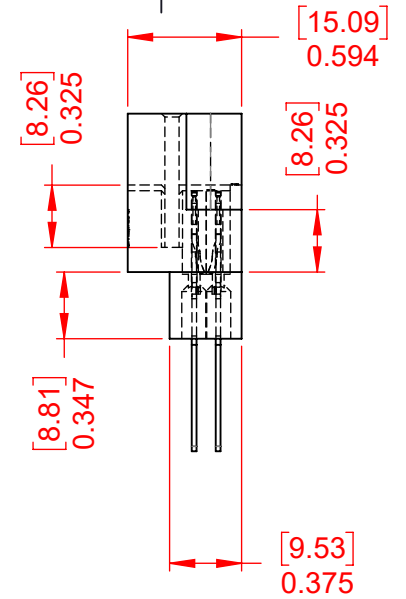
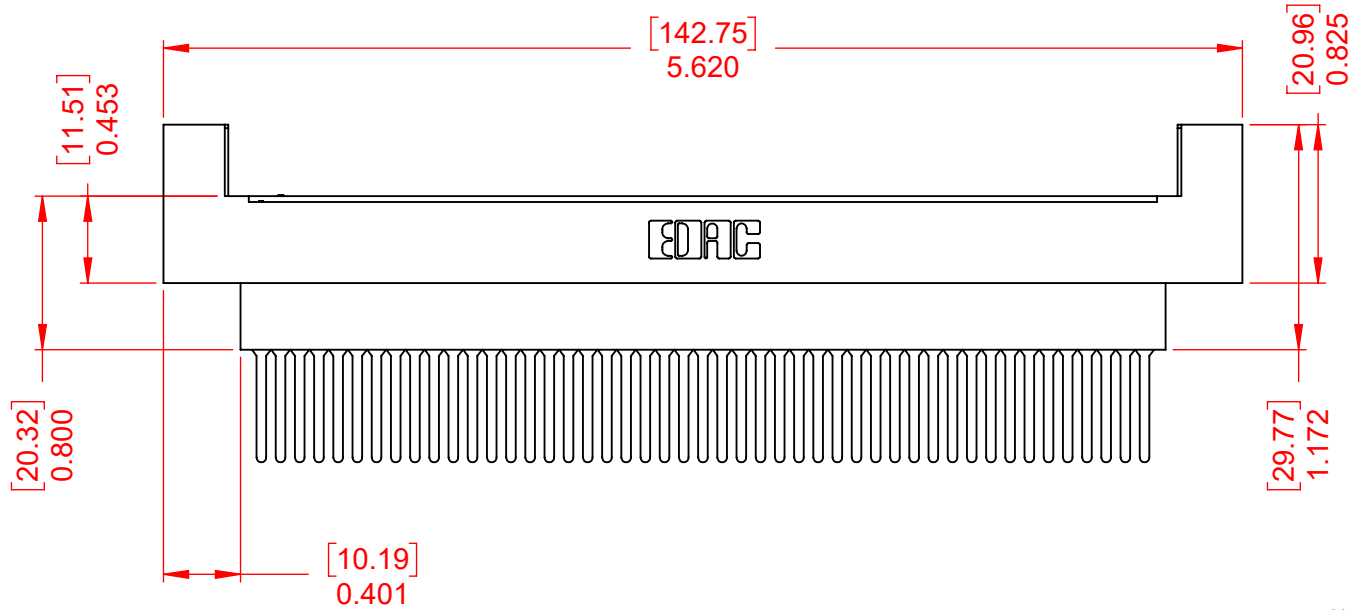

NOTES:

MATERIAL:

- HOUSING: DIALYL PTHYHALATE, UL94V-0
- CONTACT MATERIAL: COPPER ALLOY
- CONTACT PLATING: GOLD PLATING OVER NICKEL
- INSERTION FORCE: 6 TO 16 Oz (0.56 TO 4.45N) PER CONTACT
- WITHDRAWAL FORCE: 6 TO 16 Oz (0.56 TO 4.45N) PER CONTACT

OPERATING TEMPERATURE: -65°C ~ 125°C

- CURRENT RATING: 10A PER CONTACT
- CONTACT RESISTANCE: 10mΩ MAX.
- INSULATOR RESISTANCE: 5000MΩ min.
- DIELECTRIC WITHSTANDING VOLTAGE: 2000V AC rms AT SEA LEVEL

CONTACT TYPE:

540-Wire Wrap .050x.024(1.27x0.61) - Tail LG.=.600(15.24)



THIS SERIES FULLY CONFORMS TO
THE EUROPEAN UNION DIRECTIVES
2011/65/EU FOR RoHS COMPLIANCY.



YOUR CONNECTION TO QUALITY & SERVICE

EDAC INC
TORONTO, ONTARIO
CANADA

THESE DRAWINGS AND SPECIFICATIONS
ARE THE PROPERTY OF EDAC INC., AND
SHALL NOT BE REPRODUCED, OR COPIED
OR USED AS THE BASIS FOR THE
MANUFACTURE OR SALE OF APPARATUS
WITHOUT WRITTEN PERMISSION.

415 & 438 SERIES CARD EDGE

SW REFERENCE NO.: 415 ASSEMBLY	
DRAWN: W.T	DATE: AUG. 01/2018
CHECKED:	DATE:
SCALE: 1:1	SHEET 1 OF 1
DRAWING NUMBER: 415-047-540-212	ISSUE
PART NUMBER: 415-047-540-212	1