



Film Capacitors

Double Sided Metallized Polypropylene Film Capacitor MMKP

Series/Type: B32641B ... B32643B

Date: September 2020

High frequency
Typical applications

- Electronic ballasts (resonant circuits)
- LLC typology in resonant circuits
- High frequency applications with high current stress
- Switched-mode power supply

Climatic

- Max. operating temperature: 125 °C (case)
- Climatic category (IEC 60068-1): 55/110/56

Construction

- Polypropylene (PP) dielectric with double side metallized polyester (PET) film as electrodes
- Wound capacitor technology
- Plastic case (UL 94 V-0)
- Epoxy resin sealing

Features

- Very compact design
- High pulse strength
- High current withstand capability
- Halogen free available on request
- AEC-Q200D compliant

Terminals

- Parallel wire leads, lead-free tinned
- Special lead lengths available on request

Marking

Manufacturer's logo,
lot number, series number
rated capacitance (coded),
capacitance tolerance (code letter), rated DC voltage,
date of manufacture (coded)

Delivery mode

Bulk (untaped)

Taped (Ammo pack or reel)

For notes on taping, refer to chapter "Taping and packing".

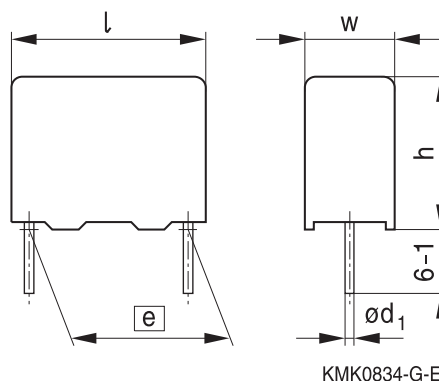
Dimensional drawing

Dimensions in mm

Lead spacing	Lead diameter	Type
$e \pm 0.4$	$d_1 \pm 0.05$	
10	0.6	B32641B
15	0.8	B32642B
22.5	0.8	B32643B

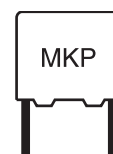

Overview of available types

Lead spacing	10 mm				15 mm					22.5 mm				
Type	B32641B				B32642B					B32643B				
Page	4				6					9				
V_R (V DC)	400	630	1000	1600	400	630	1000	1600	2000	400	630	1000	1600	2000
V_{RMS} (V AC)	250	400	500	500	250	400	500	500	500	250	400	500	500	500
C_R (nF)														
2.2														
3.3														
3.9														
4.7														
5.6														
6.8														
8.2														
10														
12														
15														
18														
22														
27														
33														
39														
47														
56														
68														
82														
100														
120														
150														
220														
330														
390														
470														
560														

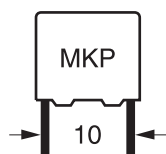
B32641B
High frequency
Ordering codes and packing units (lead spacing 10 mm)

$C_R^{1)}$	Max. dimensions $w \times h \times l$	Ordering code (composition see below)	$I_{RMS,max.}^{2)}$ 85 °C	ESR_{typ} 85 °C	$ESL_{typ}^{3)}$	Ammo pack	Reel	Untaped
nF	mm		100 kHz	100 kHz		pcs./ MOQ	pcs./ MOQ	pcs./ MOQ
A_{RMS}								
$m\Omega$								
nH								
$V_R = 400 \text{ V DC}, V_{RMS} (f \leq 1 \text{ kHz}) = 250 \text{ V AC}$								
15	4.0 × 9.0 × 13.0	B32641B4153+***	1.7	69	3.4	4000	6800	4000
18	4.0 × 9.0 × 13.0	B32641B4183+***	1.9	56	3.5	4000	6800	4000
22	4.0 × 9.0 × 13.0	B32641B4223+***	2.1	44	3.6	4000	6800	4000
27	4.0 × 9.0 × 13.0	B32641B4273+***	2.3	35	3.7	4000	6800	4000
33	5.0 × 11.0 × 13.0	B32641B4333+***	2.7	28	3.9	3320	5200	4000
39	5.0 × 11.0 × 13.0	B32641B4393+***	2.9	23	4.0	3320	5200	4000
47	5.0 × 11.0 × 13.0	B32641B4473+***	3.2	18	4.1	3320	5200	4000
56	6.0 × 12.0 × 13.0	B32641B4563+***	3.6	15	4.2	2720	4400	4000
68	6.0 × 12.0 × 13.0	B32641B4683+***	3.7	12	4.3	2720	4400	4000
82	6.0 × 14.0 × 13.0	B32641B4823+***	3.9	10	4.5	2720	4400	4000
100	7.0 × 16.0 × 13.0	B32641B4104+***	4.1	8	4.6	—	—	4000
$V_R = 630 \text{ V DC}, V_{RMS} (f \leq 1 \text{ kHz}) = 400 \text{ V AC}$								
6.8	4.0 × 9.0 × 13.0	B32641B6682+***	1.2	290	3.7	4000	6800	4000
8.2	4.0 × 9.0 × 13.0	B32641B6822+***	1.3	214	3.7	4000	6800	4000
10	4.0 × 9.0 × 13.0	B32641B6103+***	1.5	156	3.7	4000	6800	4000
12	5.0 × 11.0 × 13.0	B32641B6123+***	1.7	116	3.7	3320	5200	4000
15	5.0 × 11.0 × 13.0	B32641B6153+***	1.9	81	3.8	3320	5200	4000
18	5.0 × 11.0 × 13.0	B32641B6183+***	2.1	60	3.8	3320	5200	4000
22	6.0 × 12.0 × 13.0	B32641B6223+***	2.5	44	3.8	2720	4400	4000
27	6.0 × 12.0 × 13.0	B32641B6273+***	2.7	31	3.8	2720	4400	4000
33	6.0 × 14.0 × 13.0	B32641B6333+***	3.1	23	3.8	2720	4400	4000
39	7.0 × 16.0 × 13.0	B32641B6393+***	3.4	17	3.8	—	—	4000
47	8.0 × 17.5 × 13.0	B32641B6473+***	3.7	13	3.8	—	—	4000

MOQ = Minimum Order Quantity, consisting of 4 packing units.
Further E series and intermediate capacitance values on request.

Composition of ordering code

+ = Capacitance tolerance code:

K = ±10%

J = ±5%

*** = Packaging code:

289 = Ammo pack

189 = Reel

000 = Untaped (lead length 6 – 1 mm)

1) Capacitance value measured at 1kHz

2) Max ripple current I_{rms} at 85 °C at 100kHz for a $\Delta T \leq 15$ °C

3) Typical ESL value measured at resonance frequency (see specific graphs of Z vs frequency)

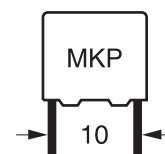
Ordering codes and packing units (lead spacing 10 mm)

$C_R^{4)}$	Max. dimensions $w \times h \times l$	Ordering code (composition see below)	$I_{RMS,max.}^{5)}$ 85 °C	ESR_{typ} 85 °C	$ESL_{typ}^{6)}$	Ammo pack	Reel	Untaped
nF	mm		100 kHz	100 kHz		pcs./ MOQ	pcs./ MOQ	pcs./ MOQ
A_{RMS} mΩ nH								
$V_R = 1000$ V DC, V_{RMS} (f ≤ 1 kHz) = 500 V AC								
4.7	4.0 × 9.0 × 13.0	B32641B0472+***	1.1	133	3.4	4000	6800	4000
5.6	4.0 × 9.0 × 13.0	B32641B0562+***	1.2	115	3.5	4000	6800	4000
6.8	5.0 × 11.0 × 13.0	B32641E0682+***	1.3	97	3.6	4000	6800	4000
8.2	5.0 × 11.0 × 13.0	B32641B0822+***	1.5	83	3.6	3320	5200	4000
10	5.0 × 11.0 × 13.0	B32641B0103+***	1.6	71	3.7	3320	5200	4000
12	5.0 × 11.0 × 13.0	B32641B0123+***	1.8	61	3.7	3320	5200	4000
15	6.0 × 12.0 × 13.0	B32641B0153+***	2.1	50	3.8	2720	4400	4000
18	6.0 × 14.0 × 13.0	B32641B0183+***	2.4	43	3.9	2720	4400	4000
22	7.0 × 16.0 × 13.0	B32641B0223+***	2.6	37	3.9	–	–	4000
27	8.0 × 17.5 × 13.0	B32641B0273+***	2.9	31	4.0	–	–	4000
33	8.0 × 17.5 × 13.0	B32641B0333+***	3.0	26	4.1	–	–	4000
$V_R = 1600$ V DC, V_{RMS} (f ≤ 1 kHz) = 500 V AC								
2.2	4.0 × 9.0 × 13.0	B32641B1222+***	0.7	526	3.7	4000	6800	4000
3.3	4.0 × 9.0 × 13.0	B32641B1332+***	1.0	305	3.8	4000	6800	4000
3.9	5.0 × 11.0 × 13.0	B32641B1392+***	1.2	244	3.8	3320	5200	4000
4.7	5.0 × 11.0 × 13.0	B32641B1472+***	1.3	190	3.8	3320	5200	4000
5.6	6.0 × 12.0 × 13.0	B32641B1562+***	1.5	150	3.8	2720	4400	4000
6.8	6.0 × 12.0 × 13.0	B32641B1682+***	1.7	116	3.9	2720	4400	4000
8.2	6.0 × 14.0 × 13.0	B32641E1822+***	1.8	90	3.9	2720	4400	4000
10	6.0 × 14.0 × 13.0	B32641B1103+***	2.0	69	3.9	2720	4400	4000
12	7.0 × 16.0 × 13.0	B32641B1123+***	2.2	54	3.9	–	–	4000
15	7.0 × 16.0 × 13.0	B32641B1153+***	2.5	40	4.0	–	–	4000
18	8.0 × 17.5 × 13.0	B32641B1183+***	2.7	31	4.0	–	–	4000

MOQ = Minimum Order Quantity, consisting of 4 packing units.
Further E series and intermediate capacitance values on request.

Composition of ordering code

+ = Capacitance tolerance code:

K = ±10%

J = ±5%

*** = Packaging code:

289 = Ammo pack

189 = Reel

000 = Untaped (lead length 6 – 1 mm)

4) Capacitance value measured at 1kHz

5) Max ripple current I_{rms} at 85 °C at 100kHz for a $\Delta T \leq 15$ °C

6) Typical ESL value measured at resonance frequency (see specific graphs of Z vs frequency)

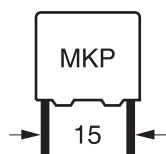
B32642B
High frequency
Ordering codes and packing units (lead spacing 15 mm)

C_R ¹⁾	Max. dimensions $w \times h \times l$	Ordering code (composition see below)	$I_{RMS,max.}$ ²⁾ 85 °C	ESR_{typ} 85 °C	ESL_{typ} ³⁾	Ammo pack	Reel	Untaped
nF	mm		100 kHz A_{RMS}	100 kHz mΩ	nH	pcs./ MOQ	pcs./ MOQ	pcs./ MOQ
$V_R = 400$ V DC, $V_{RMS} = 250$ V AC								
33	5.0 × 10.5 × 18.0	B32642B4333+***	2.2	31	5.0	4680	5200	4000
39	5.0 × 10.5 × 18.0	B32642B4393+***	2.4	27	5.0	4680	5200	4000
47	5.0 × 10.5 × 18.0	B32642B4473+***	2.6	23	5.1	4680	5200	4000
56	5.0 × 10.5 × 18.0	B32642B4563+***	2.9	20	5.1	4680	5200	4000
68	5.0 × 10.5 × 18.0	B32642B4683+***	3.1	17	5.2	4680	5200	4000
82	6.0 × 11.0 × 18.0	B32642B4823+***	3.6	15	5.3	3840	4400	4000
100	6.0 × 12.0 × 18.0	B32642B4104+***	4.1	13	5.4	3840	4400	4000
120	7.0 × 12.5 × 18.0	B32642B4124+***	4.7	11	5.4	3320	3600	4000
150	8.0 × 14.0 × 18.0	B32642B4154+***	5.7	9	5.5	2920	3000	2000
220	9.0 × 17.5 × 18.0	B32642B4224+***	6.8	7	5.7	2560	2800	2000
330	11.0 × 18.5 × 18.0	B32642B4334+***	8.2	5	5.8	—	2200	1200
390	11.0 × 18.5 × 18.0	B32642B4394+***	8.8	4	5.9	—	2200	1200
$V_R = 630$ V DC, $V_{RMS} = 400$ V AC								
15	5.0 × 10.5 × 18.0	B32642B6153+***	2.2	52	5.7	4680	5200	4000
18	5.0 × 10.5 × 18.0	B32642B6183+***	2.2	43	5.7	4680	5200	4000
22	5.0 × 10.5 × 18.0	B32642B6223+***	2.3	36	5.7	4680	5200	4000
27	5.0 × 10.5 × 18.0	B32642B6273+***	2.3	29	5.8	4680	5200	4000
33	5.0 × 10.5 × 18.0	B32642B6333+***	2.5	24	5.8	4680	5200	4000
39	6.0 × 11.0 × 18.0	B32642B6393+***	2.7	20	5.8	3840	4400	4000
47	6.0 × 12.0 × 18.0	B32642B6473+***	3.0	17	5.9	3840	4400	4000
56	7.0 × 12.5 × 18.0	B32642B6563+***	3.4	14	5.9	3320	3600	4000
68	8.0 × 14.0 × 18.0	B32642B6683+***	4.0	12	5.9	2920	3000	2000
82	8.5 × 14.5 × 18.0	B32642B6823+***	4.3	10	6.0	2720	2800	2000
100	8.5 × 14.5 × 18.0	B32642B6104+***	4.7	8	6.0	2720	2800	2000
120	9.0 × 17.5 × 18.0	B32642B6124+***	5.1	7	6.0	2560	2800	2000
150	11.0 × 18.5 × 18.0	B32642B6154+***	5.6	5	6.1	—	2200	1200

MOQ = Minimum Order Quantity, consisting of 4 packing units.

Further E series and intermediate capacitance values on request.

Composition of ordering code

+ = Capacitance tolerance code:

K = ±10%

J = ±5%

*** = Packaging code:

289 = Ammo pack

189 = Reel

000 = Untaped (lead length 6 – 1 mm)

1) Capacitance value measured at 1kHz

2) Max ripple current I_{rms} at 85 °C at 100kHz for a $\Delta T \leq 15$ °C

3) Typical ESL value measured at resonance frequency (see specific graphs of Z vs frequency)

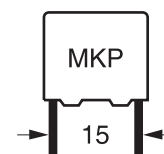
Ordering codes and packing units (lead spacing 15 mm)

$C_R^{4)}$	Max. dimensions $w \times h \times l$	Ordering code (composition see below)	$I_{RMS,max.}^{5)}$ 85 °C	ESR_{typ} 85 °C	$ESL_{typ}^{6)}$	Ammo pack	Reel	Untaped
nF	mm		100 kHz	100 kHz		pcs./ MOQ	pcs./ MOQ	pcs./ MOQ
$V_R = 1000 \text{ V DC}, V_{RMS} = 500 \text{ V AC}$								
10	5.0 × 10.5 × 18.0	B32642B0103+***	1.6	64	3.8	4680	5200	4000
12	5.0 × 10.5 × 18.0	B32642B0123+***	1.8	54	4.0	4680	5200	4000
15	5.0 × 10.5 × 18.0	B32642B0153+***	1.9	44	4.2	4680	5200	4000
18	6.0 × 11.0 × 18.0	B32642B0183+***	2.1	37	4.3	3840	4400	4000
22	6.0 × 11.0 × 18.0	B32642B0223+***	2.3	31	4.5	3840	4400	4000
27	6.0 × 12.0 × 18.0	B32642B0273+***	2.5	25	4.7	3840	4400	4000
33	7.0 × 12.5 × 18.0	B32642B0333+***	2.9	21	4.9	3320	3600	4000
39	8.0 × 14.0 × 18.0	B32642B0393+***	3.3	18	5.0	2920	3000	2000
47	8.5 × 14.5 × 18.0	B32642B0473+***	3.5	15	5.2	2720	3000	2800
56	8.5 × 14.5 × 18.0	B32642B0563+***	3.7	13	5.4	2720	2800	2000
68	9.0 × 17.5 × 18.0	B32642B0683+***	4.1	11	5.6	2560	2800	2000
82	11.0 × 18.5 × 18.0	B32642B0823+***	4.4	9	5.8	–	2200	1200
100	11.0 × 18.5 × 18.0	B32642B0104+***	4.8	7	6.1	–	2200	1200
$V_R = 1600 \text{ V DC}, V_{RMS} = 500 \text{ V AC}$								
4.7	5.0 × 10.5 × 18.0	B32642B1472+***	1.2	224	3.8	4680	5200	4000
5.6	5.0 × 10.5 × 18.0	B32642B1562+***	1.3	175	3.9	4680	5200	4000
6.8	5.0 × 10.5 × 18.0	B32642B1682+***	1.5	134	4.0	4680	5200	4000
8.2	5.0 × 10.5 × 18.0	B32642B1822+***	1.6	103	4.1	4680	5200	4000
10	5.0 × 10.5 × 18.0	B32642B1103+***	1.8	78	4.2	4680	5200	4000
12	6.0 × 11.0 × 18.0	B32642B1123+***	2.1	60	4.4	3840	4400	4000
15	6.0 × 11.0 × 18.0	B32642B1153+***	2.1	44	4.5	3840	4400	4000
18	7.0 × 12.5 × 18.0	B32642E1183+***	2.3	34	4.6	3840	4400	4000
22	7.0 × 12.5 × 18.0	B32642B1223+***	2.6	26	4.8	3320	3600	4000
27	8.0 × 14.0 × 18.0	B32642B1273+***	3.0	19	4.9	2920	3000	2000
33	8.5 × 14.5 × 18.0	B32642B1333+***	3.3	15	5.1	2720	2800	2000
39	9.0 × 17.5 × 18.0	B32642B1393+***	3.5	12	5.2	2560	2800	2000
47	9.0 × 17.5 × 18.0	B32642B1473+***	3.7	9	5.3	2560	2800	2000
56	11.0 × 18.5 × 18.0	B32642B1563+***	3.9	7	5.5	–	2200	1200

MOQ = Minimum Order Quantity, consisting of 4 packing units.
Further E series and intermediate capacitance values on request.

Composition of ordering code

+ = Capacitance tolerance code:
K = ±10%
J = ±5%

*** = Packaging code:
289 = Ammo pack
189 = Reel
000 = Untaped (lead length 6 – 1 mm)

4) Capacitance value measured at 1kHz

5) Max ripple current I_{rms} at 85 °C at 100kHz for a $\Delta T \leq 15$ °C

6) Typical ESL value measured at resonance frequency (see specific graphs of Z vs frequency)

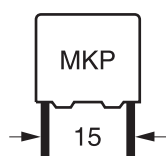

B32642B

High frequency

Ordering codes and packing units (lead spacing 15 mm)

C_R ⁷⁾	Max. dimensions $w \times h \times l$	Ordering code (composition see below)	$I_{RMS,max.}$ ⁸⁾ 85 °C	ESR_{typ} 85 °C	ESL_{typ} ⁹⁾	Ammo pack	Reel	Untaped
nF	mm		100 kHz	100 kHz		pcs./ MOQ	pcs./ MOQ	pcs./ MOQ
A_{RMS} $m\Omega$ nH								
$V_R = 2000\text{ V DC}, V_{RMS} = 500\text{ V AC}$								
3.3	5.0 × 10.5 × 18.0	B32642B8332+***	1.0	256	4.4	4680	5200	4000
3.9	5.0 × 10.5 × 18.0	B32642B8392+***	1.2	211	4.4	4680	5200	4000
4.7	5.0 × 10.5 × 18.0	B32642B8472+***	1.4	169	4.5	4680	5200	4000
5.6	6.0 × 11.0 × 18.0	B32642B8562+***	1.6	138	4.5	3840	4400	4000
6.8	6.0 × 11.0 × 18.0	B32642B8682+***	1.7	110	4.6	3840	4400	4000
8.2	7.0 × 12.5 × 18.0	B32642B8822+***	2.1	88	4.6	3320	3600	4000
10	7.0 × 12.5 × 18.0	B32642B8103+***	2.3	70	4.7	3320	3600	4000
12	8.0 × 14.0 × 18.0	B32642B8123+***	2.7	56	4.8	2920	3000	2000
15	8.5 × 14.5 × 18.0	B32642B8153+***	3.0	43	4.8	2720	2800	2000
18	9.0 × 17.5 × 18.0	B32642B8183+***	3.3	35	4.9	2560	2800	2000
22	9.0 × 17.5 × 18.0	B32642B8223+***	3.7	28	5.0	2560	2800	2000
27	11.0 × 18.5 × 18.0	B32642B8273+***	4.1	22	5.0	—	2200	1200

MOQ = Minimum Order Quantity, consisting of 4 packing units.
Further E series and intermediate capacitance values on request.

Composition of ordering code

+ = Capacitance tolerance code:

K = ±10%

J = ±5%

*** = Packaging code:

289 = Ammo pack

189 = Reel

000 = Untaped (lead length 6 – 1 mm)

7) Capacitance value measured at 1kHz

8) Max ripple current I_{rms} at 85 °C at 100kHz for a $\Delta T \leq 15$ °C

9) Typical ESL value measured at resonance frequency (see specific graphs of Z vs frequency)

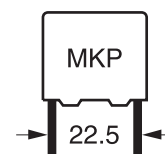
B32643B
High frequency

Ordering codes and packing units (lead spacing 22.5 mm)

$C_R^{1)}$	Max. dimensions $w \times h \times l$	Ordering code (composition see below)	$I_{RMS,max.}^{2)}$ 85 °C 100 kHz A_{RMS}	ESR_{typ} 85 °C 100 kHz mΩ	$ESL_{typ}^{3)}$ nH	Ammo pack pcs./ MOQ	Reel pcs./ MOQ	Untaped pcs./ MOQ
nF	mm							
$V_R = 400 \text{ V DC}, V_{RMS} = 250 \text{ V AC}$								
120	6.0 × 15.0 × 26.5	B32643B4124+***	2.7	10	8.5	2720	2800	2880
150	6.0 × 15.0 × 26.5	B32643B4154+***	3.1	9	9.0	2720	2800	2880
220	7.0 × 16.0 × 26.5	B32643B4224+***	3.7	7	9.7	2320	2400	2520
330	8.5 × 16.5 × 26.5	B32643B4334+***	4.5	6	10.7	1920	2000	2040
390	8.5 × 16.5 × 26.5	B32643B4394+***	5.0	5	11.0	1920	2000	2040
470	10.5 × 18.5 × 26.5	B32643B4474+***	5.5	5	11.5	1560	1600	2160
560	10.5 × 18.5 × 26.5	B32643B4564+***	6.0	4	12.0	1560	1600	2160
$V_R = 630 \text{ V DC}, V_{RMS} = 400 \text{ V AC}$								
68	6.0 × 15.0 × 26.5	B32643B6683+***	3.1	50	8.3	2720	2800	2880
82	6.0 × 15.0 × 26.5	B32643B6823+***	3.3	40	8.5	2720	2800	2880
100	6.0 × 15.0 × 26.5	B32643B6104+***	3.6	32	8.8	2720	2800	2880
120	6.0 × 15.0 × 26.5	B32643B6124+***	3.9	26	9.1	2720	2800	2880
150	7.0 × 16.0 × 26.5	B32643B6154+***	4.5	20	9.5	2320	2400	2520
220	10.5 × 16.5 × 26.5	B32643B6224+***	5.8	13	10.1	1560	1600	2160
330	11.0 × 20.5 × 26.5	B32643B6334+***	7.6	8	10.8	1480	1400	2040
390	12.0 × 22.0 × 26.5	B32643B6394+***	8.2	7	11.1	–	–	1800
470	14.5 × 29.5 × 26.5	B32643B6474+***	8.9	6	11.5	–	–	1040

MOQ = Minimum Order Quantity, consisting of 4 packing units.
Further E series and intermediate capacitance values on request.

Composition of ordering code

+ = Capacitance tolerance code:

K = ±10%

J = ±5%

*** = Packaging code:

289 = Ammo pack

189 = Reel

000 = Untaped (lead length 6 – 1 mm)

1) Capacitance value measured at 1kHz

2) Max ripple current I_{rms} at 85 °C at 100kHz for a $\Delta T \leq 15$ °C

3) Typical ESL value measured at resonance frequency (see specific graphs of Z vs frequency)

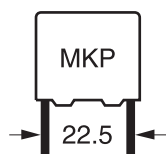
B32643B
High frequency
Ordering codes and packing units (lead spacing 22.5 mm)

$C_R^{4)}$	Max. dimensions $w \times h \times l$	Ordering code (composition see below)	$I_{RMS,max.}^{5)}$ 85 °C 100 kHz A_{RMS}	ESR_{typ} 85 °C 100 kHz mΩ	$ESL_{typ}^{6)}$ nH	Ammo pack pcs./ MOQ	Reel pcs./ MOQ	Untaped pcs./ MOQ
nF	mm							
$V_R = 1000 \text{ V DC}, V_{RMS} = 500 \text{ V AC}$								
33	6.0 × 15.0 × 26.5	B32643B0333+***	2.4	29	9.1	2720	2800	2880
39	6.0 × 15.0 × 26.5	B32643B0393+***	2.6	25	9.2	2720	2800	2880
47	6.0 × 15.0 × 26.5	B32643B0473+***	2.8	22	9.3	2720	2800	2880
56	6.0 × 15.0 × 26.5	B32643B0563+***	3.0	19	9.4	2720	2800	2880
68	7.0 × 16.0 × 26.5	B32643B0683+***	3.4	17	9.6	2320	2400	2520
82	7.0 × 16.0 × 26.5	B32643B0823+***	3.7	15	9.7	2320	2400	2520
100	8.5 × 16.5 × 26.5	B32643B0104+***	4.2	13	9.8	1920	2000	2040
120	10.5 × 16.5 × 26.5	B32643B0124+***	4.7	11	10.0	1560	1600	2160
150	10.5 × 18.5 × 26.5	B32643B0154+***	5.4	9	10.1	1560	1600	2160
220	12.0 × 22.0 × 26.5	B32643B0224+***	6.6	7	10.4	—	—	1800
330	14.5 × 29.5 × 26.5	B32643B0334+***	7.8	5	10.7	—	—	1040
390	14.5 × 29.5 × 26.5	B32643B0394+***	8.3	5	10.8	—	—	1040
$V_R = 1600 \text{ V DC}, V_{RMS} = 500 \text{ V AC}$								
22	6.0 × 15.0 × 26.5	B32643B1223+***	2.8	35	6.8	2720	2800	2880
27	6.0 × 15.0 × 26.5	B32643B1273+***	3.0	29	7.0	2720	2800	2880
33	6.0 × 15.0 × 26.5	B32643B1333+***	3.3	25	7.2	2720	2800	2880
39	7.0 × 16.0 × 26.5	B32643B1393+***	3.7	21	7.3	2320	2400	2520
47	7.0 × 16.0 × 26.5	B32643B1473+***	4.0	18	7.5	2320	2400	2520
56	8.5 × 16.5 × 26.5	B32643B1563+***	4.4	16	7.6	1920	2000	2040
68	10.5 × 16.5 × 26.5	B32643E1683+***	4.7	13	7.8	1920	2000	2040
82	10.5 × 16.5 × 26.5	B32643B1823+***	5.3	11	8.0	1560	1600	2160
100	10.5 × 18.5 × 26.5	B32643B1104+***	6.0	10	8.2	1560	1600	2160
120	12.0 × 22.0 × 26.5	B32643B1124+***	6.6	8	8.4	—	—	1800
150	14.5 × 29.5 × 26.5	B32643B1154+***	7.3	7	8.6	—	—	1040
220	14.5 × 29.5 × 26.5	B32643B1224+***	8.7	5	9.0	—	—	1040

MOQ = Minimum Order Quantity, consisting of 4 packing units.
Further E series and intermediate capacitance values on request.

Composition of ordering code

+ = Capacitance tolerance code:

K = ±10%

J = ±5%

*** = Packaging code:

289 = Ammo pack

189 = Reel

000 = Untaped (lead length 6 – 1 mm)

4) Capacitance value measured at 1kHz

 5) Max ripple current I_{rms} at 85 °C at 100kHz for a $\Delta T \leq 15$ °C

6) Typical ESL value measured at resonance frequency (see specific graphs of Z vs frequency)

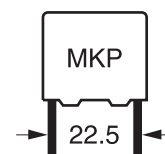
Ordering codes and packing units (lead spacing 22.5 mm)

C_R ⁷⁾	Max. dimensions $w \times h \times l$	Ordering code (composition see below)	$I_{RMS,max}$ ⁸⁾ 85 °C 100 kHz A_{RMS}	ESR_{typ} 85 °C 100 kHz mΩ	ESL_{typ} ⁹⁾ nH	Ammo pack pcs./ MOQ	Reel pcs./ MOQ	Untaped pcs./ MOQ
nF	mm							
$V_R = 2000$ V DC, $V_{RMS} = 500$ V AC								
10	6.0 × 15.0 × 26.5	B32643B8103+***	2.3	73	8.8	2720	2800	2880
12	6.0 × 15.0 × 26.5	B32643B8123+***	2.5	62	9.0	2720	2800	2880
15	6.0 × 15.0 × 26.5	B32643B8153+***	2.8	50	9.2	2720	2800	2880
18	6.0 × 15.0 × 26.5	B32643B8183+***	3.1	42	9.4	2720	2800	2880
22	6.0 × 15.0 × 26.5	B32643B8223+***	3.4	35	9.5	2720	2800	2880
27	7.0 × 16.0 × 26.5	B32643B8273+***	3.9	29	9.7	2320	2400	2520
33	8.5 × 16.5 × 26.5	B32643B8333+***	4.6	24	9.9	1920	2000	2040
39	8.5 × 16.5 × 26.5	B32643B8393+***	5.0	20	10.1	1920	2000	2040
47	10.5 × 16.5 × 26.5	B32643B8473+***	5.7	17	10.3	1560	1600	2160
56	10.5 × 18.5 × 26.5	B32643B8563+***	6.2	14	10.4	1560	1600	2160
68	11.0 × 20.5 × 26.5	B32643B8683+***	6.8	12	10.6	1480	1400	2040
82	12.0 × 22.0 × 26.5	B32643B8823+***	7.5	10	10.8	–	–	1800
100	14.5 × 29.5 × 26.5	B32643B8104+***	8.3	8	11.0	–	–	1040
120	14.5 × 29.5 × 26.5	B32643B8124+***	9.1	7	11.2	–	–	1040

MOQ = Minimum Order Quantity, consisting of 4 packing units.

Further E series and intermediate capacitance values on request.

Composition of ordering code

+ = Capacitance tolerance code:

K = ±10%

J = ±5%

*** = Packaging code:

289 = Ammo pack

189 = Reel

000 = Untaped (lead length 6 – 1 mm)

7) Capacitance value measured at 1kHz

8) Max ripple current I_{rms} at 85 °C at 100kHz for a $\Delta T \leq 15$ °C

9) Typical ESL value measured at resonance frequency (see specific graphs of Z vs frequency)

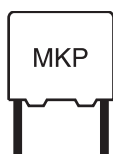

B32641B ... B32643B

High frequency

Technical data

Reference standard: IEC 60384-16:2005 and AEC-Q200D. All data given at $T = 20\text{ °C}$, unless otherwise specified.

Rated temperature T_R	+85 °C	
Operating temperature range	Max. operating temperature $T_{op,max}$ +125 °C Upper category temperature T_{max} +110 °C Lower category temperature T_{min} -55 °C Rated temperature T_R +85 °C	
Dissipation factor $\tan \delta$ (in 10^{-3}) at 20 °C (upper limit values)	1 kHz	0.6
	10 kHz	0.6
	100 kHz	1.5
Insulation resistance R_{ins} at 20 °C, rel. humidity $\leq 65\%$ (minimum as-delivered values)	$C_R \leq 0.33\ \mu\text{F}$; 100 G Ω $C_R > 0.33\ \mu\text{F}$; 30000 S	
Test voltage (terminal to terminal)	$1.6 \cdot V_R$, 2 s	
Test voltage (terminal to case)	2000 V AC, 60s	
Category voltage V_C (continuous operation with V_{DC})	T_{op} (°C)	DC voltage derating
	$T_{op} \leq 85$ $85 < T_{op} \leq 125$	$V_C = V_R$ $V_C = V_R \cdot (165 - T_{op})/80$
Operating voltage V_{op} for short operating periods (V_{DC})	T_{op} (°C)	DC voltage (max. hours)
	$T_{op} \leq 85$ $85 < T_{op} \leq 125$	$V_{op} = 1.25 \cdot V_C$ (1000 h) $V_{op} = 1.25 \cdot V_C$ (1000 h)
Reliability		
Failure rate λ	1 fit ($\leq 1 \cdot 10^{-9}/h$) at $0.5 \cdot V_R$, 40 °C	
Service life t_{SL}	200 000 h at $1.0 \cdot V_R$, 85 °C	
Failure criteria:	For conversion to other operating conditions and temperatures, refer to chapter "Quality, 2 Reliability".	
Total failure	Short circuit or open circuit	
Failure due to variation of parameters	Capacitance change $ \Delta C/C $	> 10%
	Dissipation factor $\tan \delta$	> 4 · upper limit value
	Insulation resistance R_{ins}	< 1500 M Ω

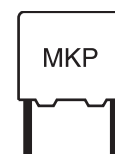

Pulse handling capability

"dV/dt" represents the maximum permissible voltage change per unit of time for non-sinusoidal voltages, expressed in V/μs.

"k₀" represents the maximum permissible pulse characteristic of the waveform applied to the capacitor, expressed in V²/μs.

Note:

The values of dV/dt and k₀ provided below must not be exceeded in order to avoid damaging the capacitor. These parameters are given for isolated pulses in such a way that the heat generated by one pulse will be completely dissipated before applying the next pulse. For a train of pulses, please refer to the curves of permissible AC voltage-current versus frequency.

dV/dt values

Lead spacing		10 mm	15 mm	22.5 mm
V _R V DC	V _{RMS} V AC	dV/dt in V/μs		
400	250	1500	900	500
630	400	4000	2700	1500
1000	500	6200	3500	2100
1600	500	8000	5300	3000
2000	500	—	6500	3800

k₀ values

Lead spacing		10 mm	15 mm	22.5 mm
V _R V DC	V _{RMS} V AC	k ₀ in V ² /μs		
400	250	1 200 000	720 000	400 000
630	400	5 040 000	3 402 000	1 890 000
1000	500	12 400 000	7 000 000	4 200 000
1600	500	25 600 000	16 960 000	9 600 000
2000	500	—	26 000 000	15 000 000

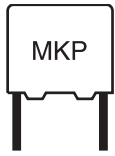

B32641B ... B32643B

High frequency

Impedance Z versus frequency f
(typical values)

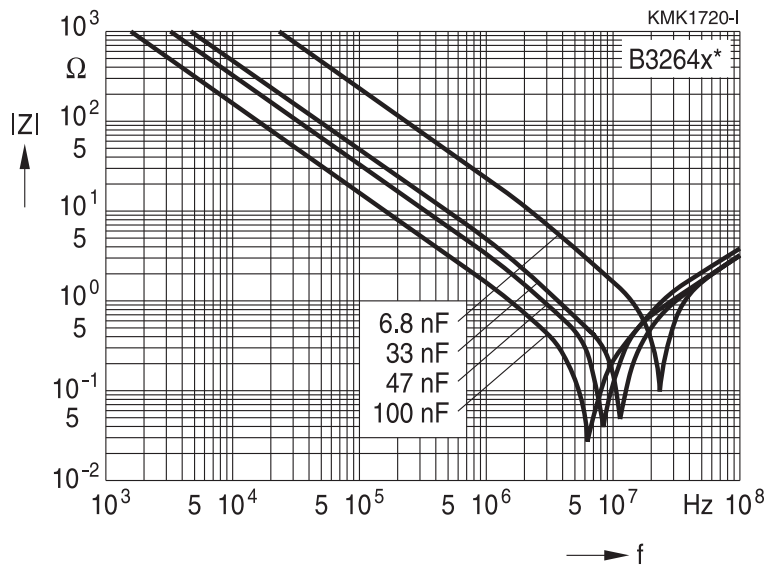

B32641B

High frequency

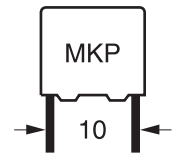

Permissible AC voltage V_{RMS} versus frequency f (for sinusoidal waveforms, $T_A \leq 85^\circ C$, $\Delta T \leq 15^\circ C$)

Lead spacing 10 mm

400 V DC/250 V AC

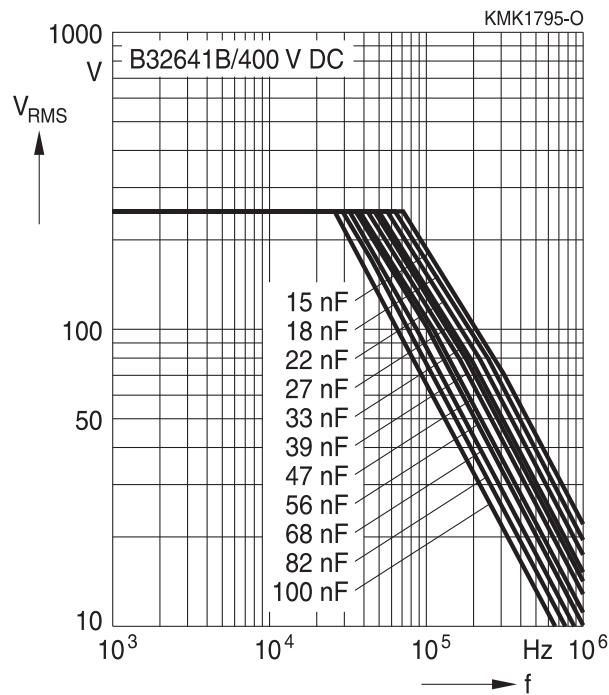

630 V DC/400 V AC

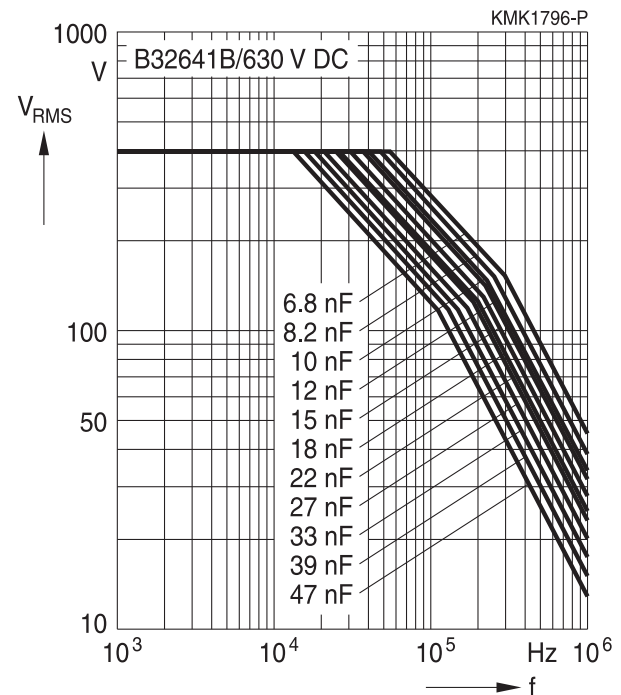

1000 V DC/500 V AC

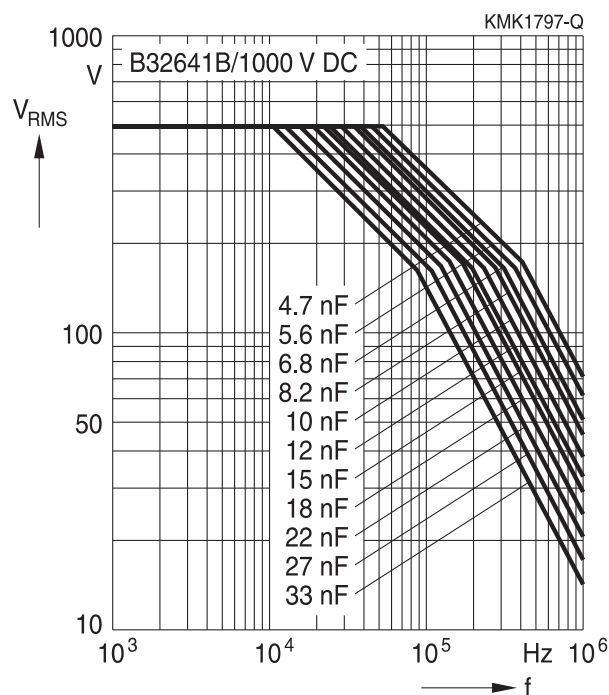

1600 V DC/500 V AC

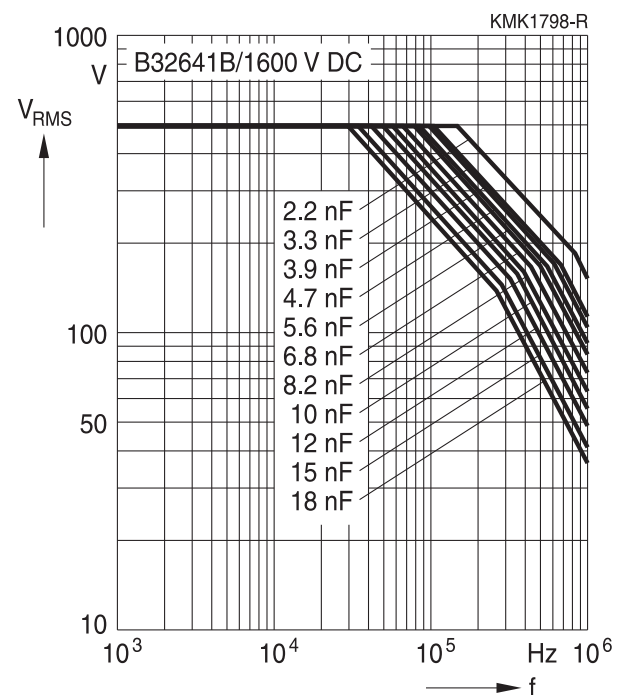

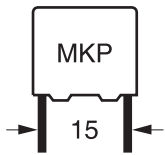

B32642B

High frequency

Permissible AC voltage V_{RMS} versus frequency f (for sinusoidal waveforms, $T_A \leq 85^\circ\text{C}$, $\Delta T \leq 15^\circ\text{C}$)

Lead spacing 15 mm

400 V DC/250 V AC

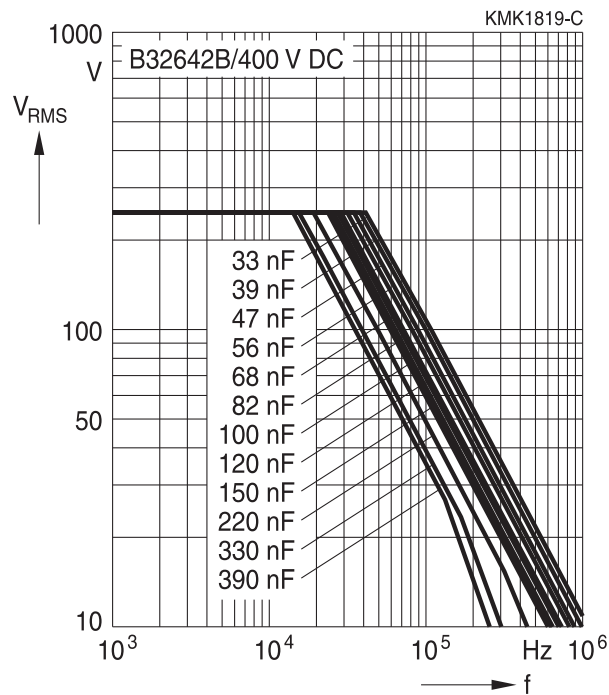

630 V DC/400 V AC

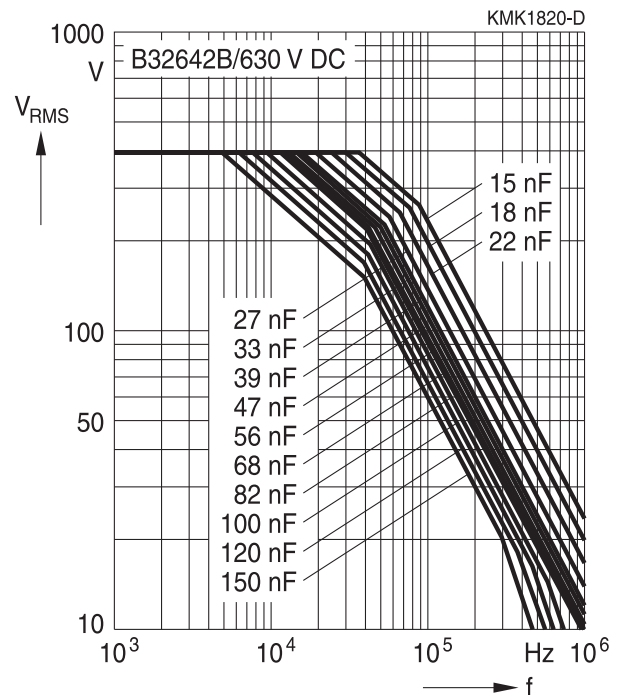

1000 V DC/500 V AC

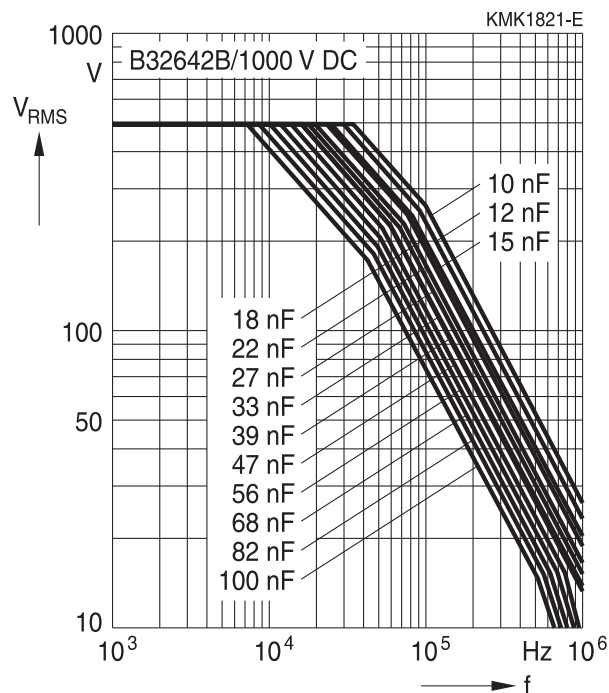

1600 V DC/500 V AC

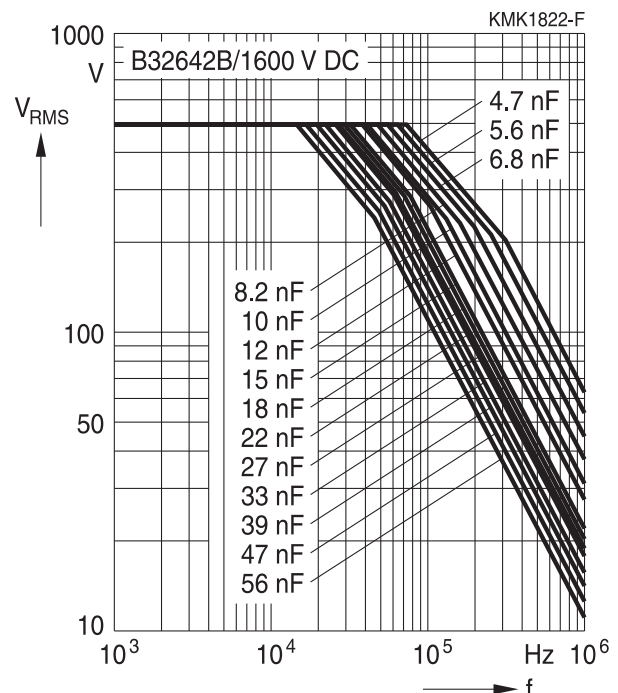

B32642B
High frequency

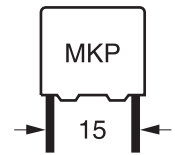

Permissible AC voltage V_{RMS} versus frequency f (for sinusoidal waveforms, $T_A \leq 85^\circ\text{C}$, $\Delta T \leq 15^\circ\text{C}$)

Lead spacing 15 mm

2000 V DC/500 V AC

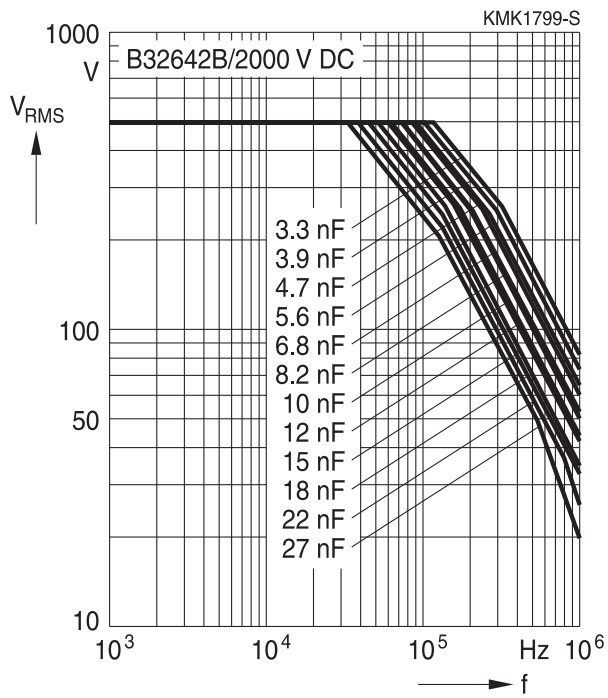

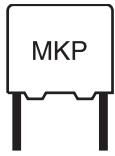

B32641B ... B32643B

High frequency

Permissible AC voltage V_{RMS} versus frequency f (for sinusoidal waveforms, $T_A \leq 85^\circ\text{C}$, $\Delta T \leq 15^\circ\text{C}$)

Lead spacing 22.5 mm

400 V DC/250 V AC

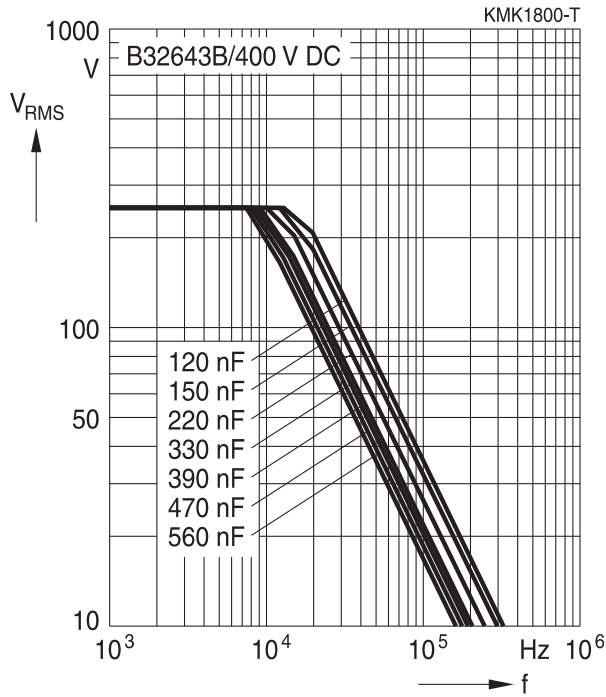

630 V DC/400 V AC

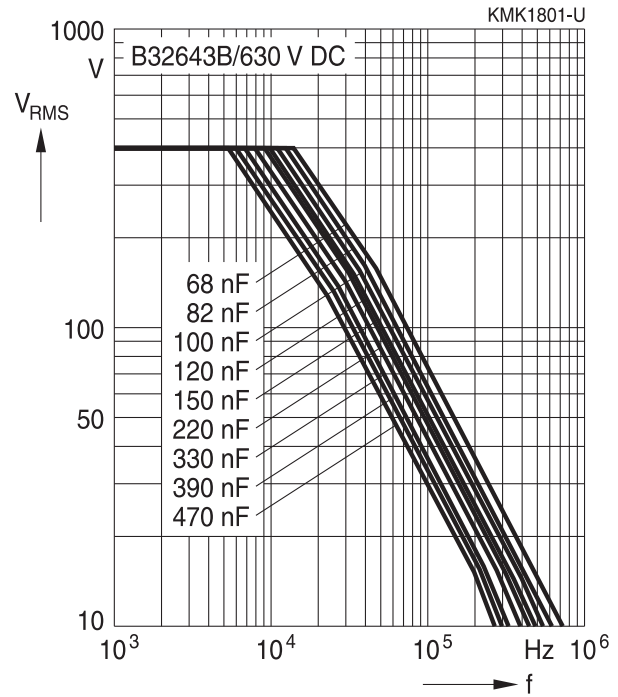

1000 V DC/500 V AC

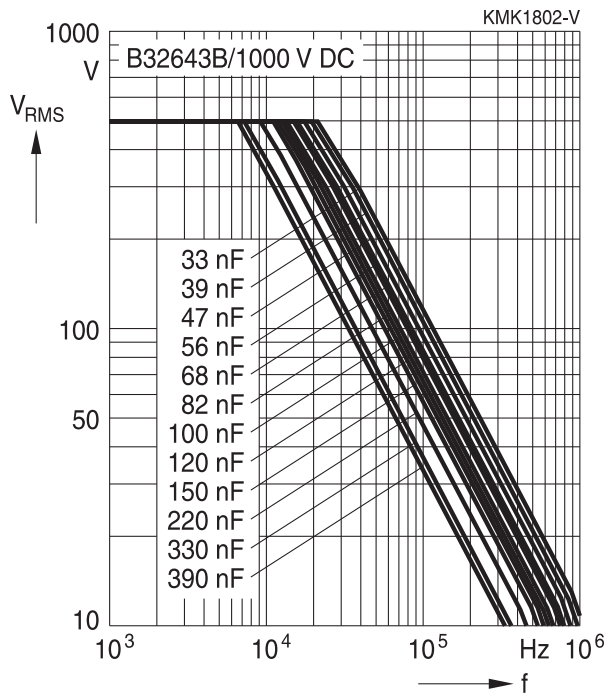

1600 V DC/500 V AC

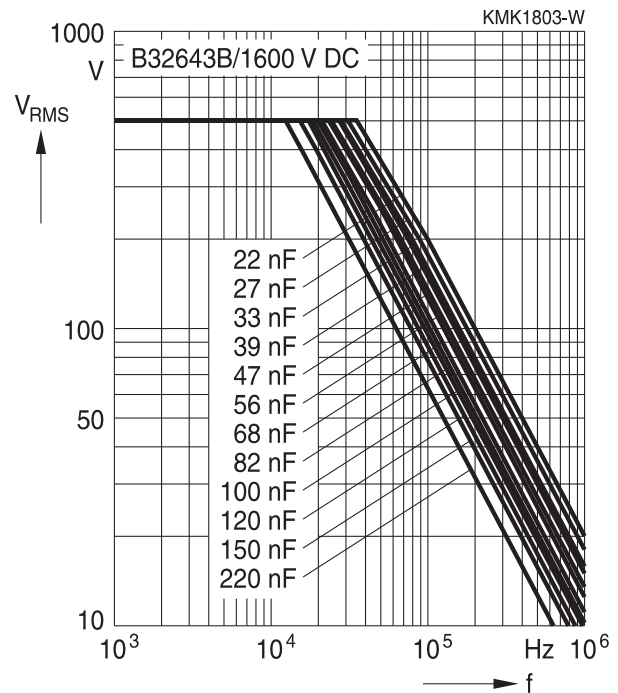

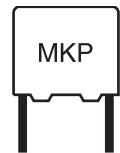

Permissible AC voltage V_{RMS} versus frequency f (for sinusoidal waveforms, $T_A \leq 85\text{ }^\circ\text{C}$, $\Delta T \leq 15\text{ }^\circ\text{C}$)

Lead spacing 22.5 mm

2000 V DC/500 V AC

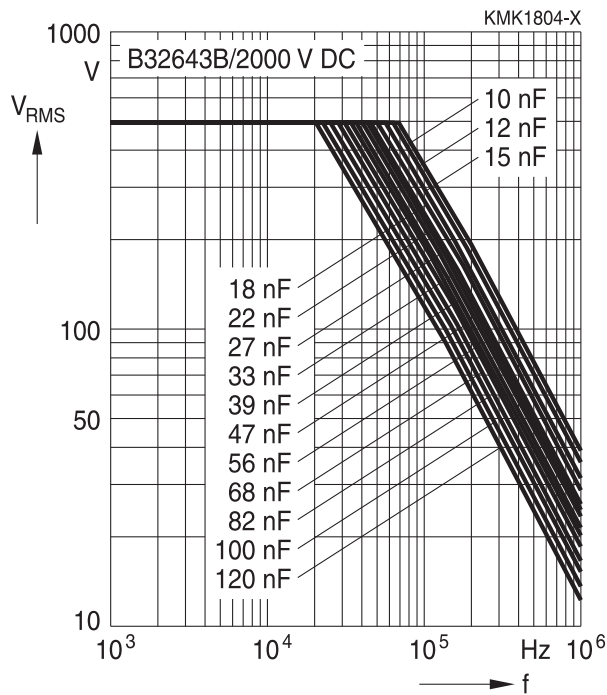

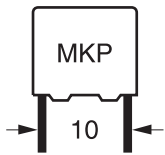

B32641B

High frequency

Permissible current I_{RMS} versus frequency f (for sinusoidal waveforms, $T_A \leq 85^\circ\text{C}$, $\Delta T \leq 15^\circ\text{C}$)

Lead spacing 10 mm

400 V DC/250 V AC

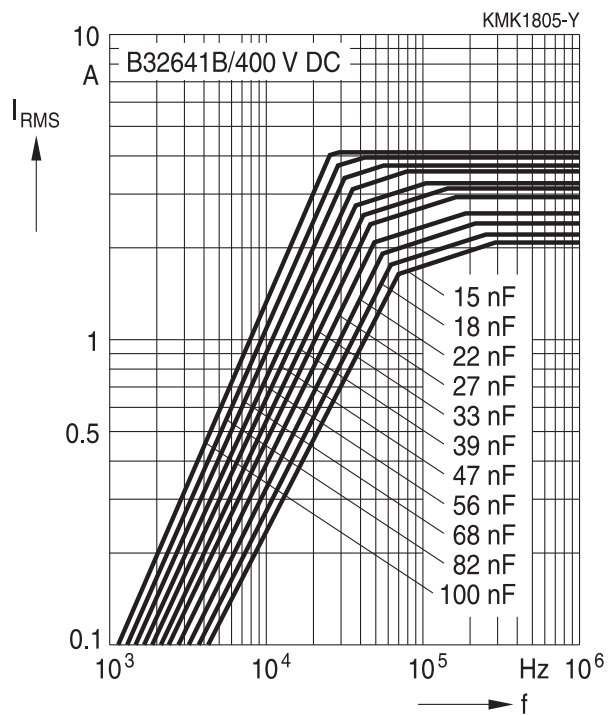

630 V DC/400 V AC

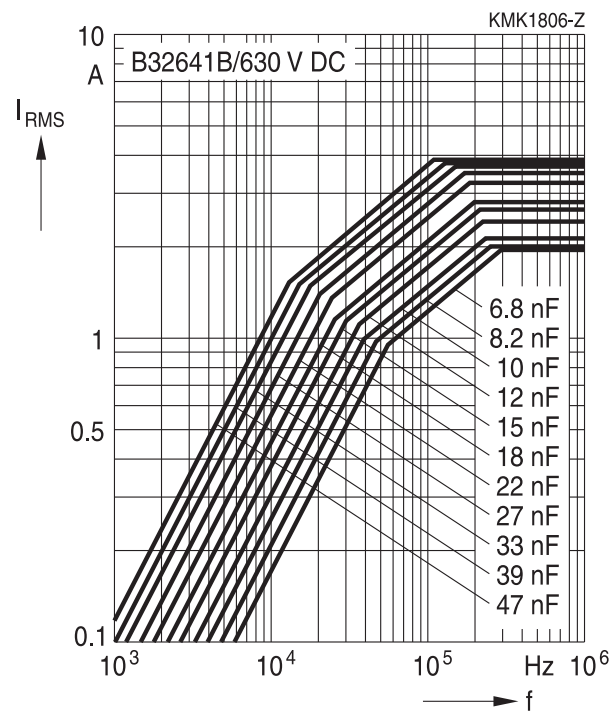

1000 V DC/500 V AC

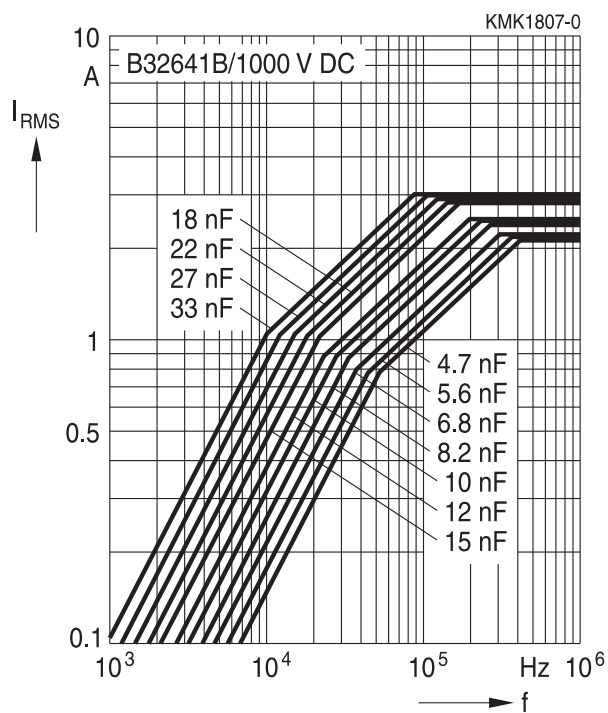

1600 V DC/500 V AC

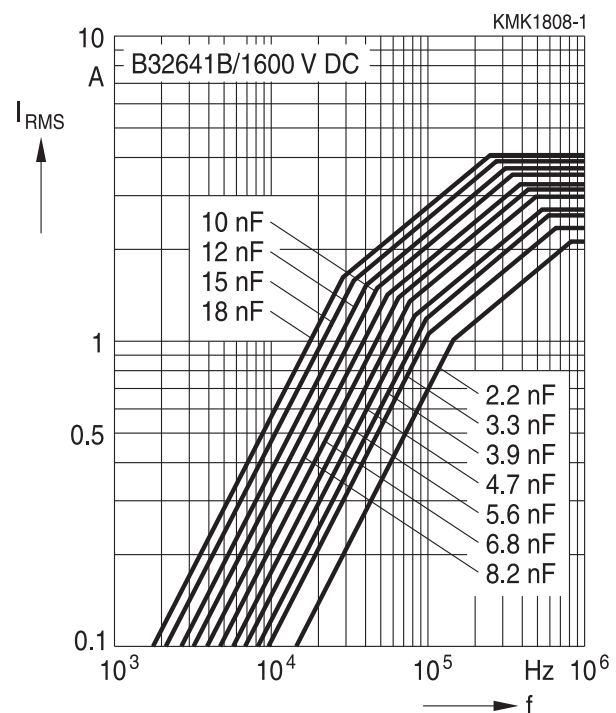

B32642B

High frequency

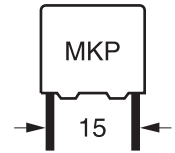

Permissible current I_{RMS} versus frequency f (for sinusoidal waveforms, $T_A \leq 85^\circ C$, $\Delta T \leq 15^\circ C$)

Lead spacing 15 mm

400 V DC/250 V AC

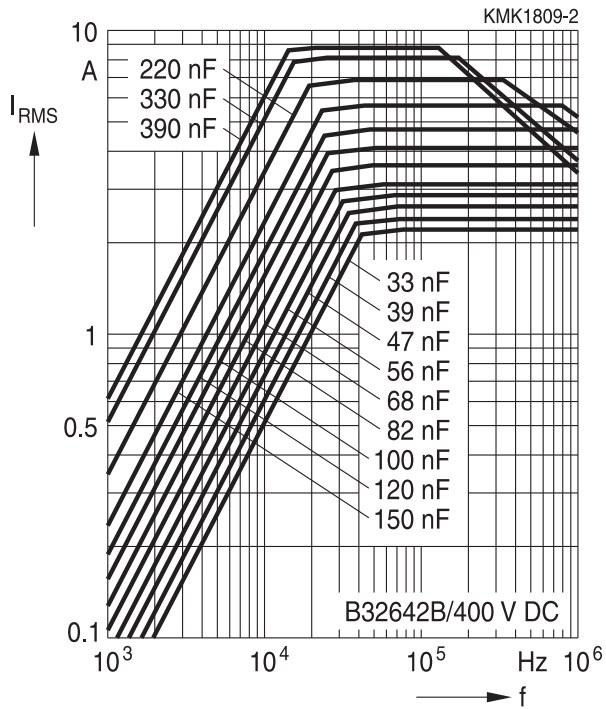

630 V DC/400 V AC

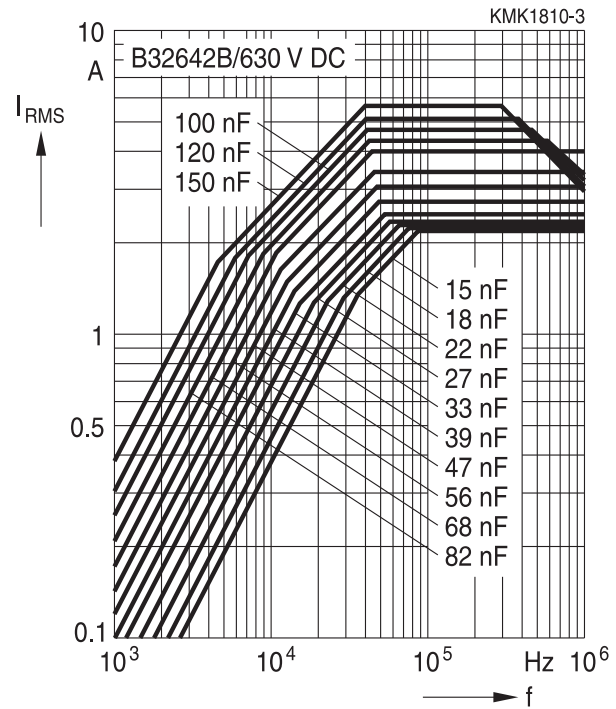

1000 V DC/500 V AC

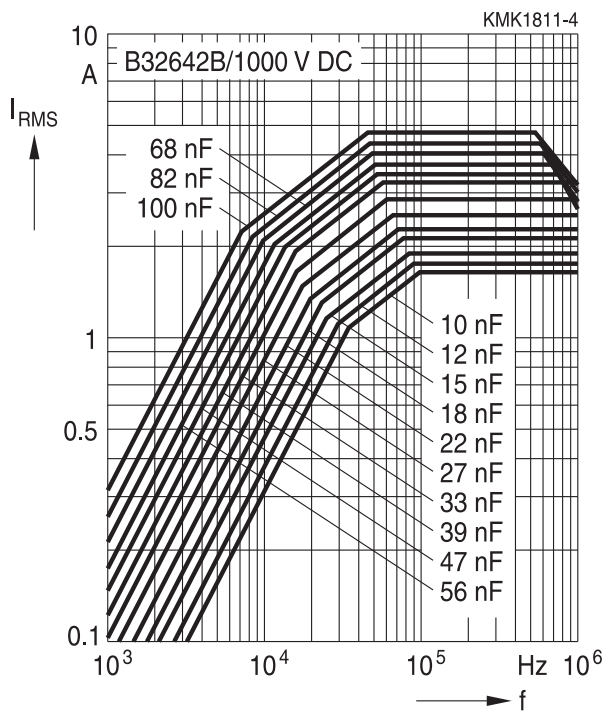

1600 V DC/500 V AC

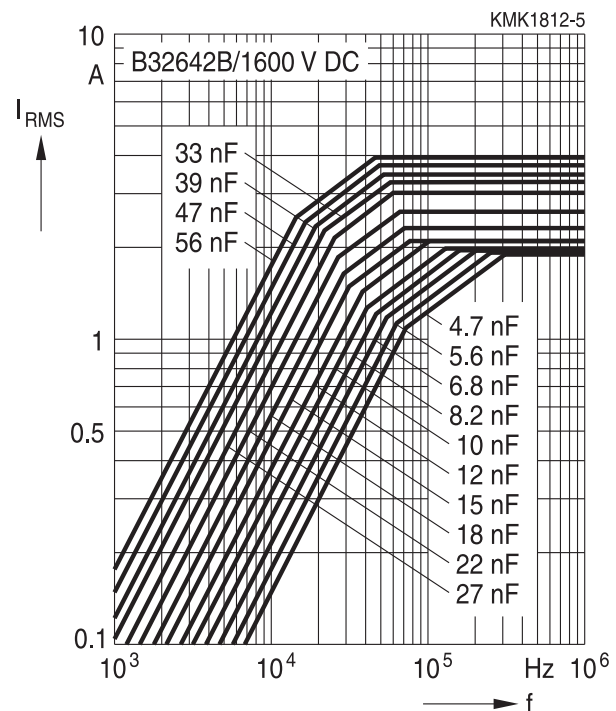

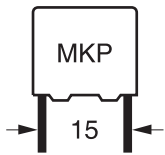

B32642B

High frequency

Permissible current I_{RMS} versus frequency f (for sinusoidal waveforms, $T_A \leq 85\text{ °C}$, $\Delta T \leq 15\text{ °C}$)

Lead spacing 15 mm

2000 V DC/500 V AC

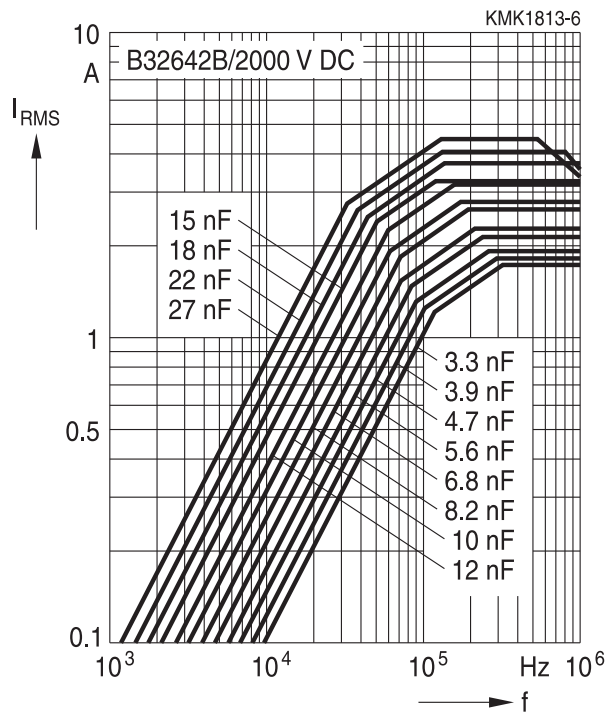

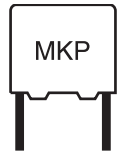

Permissible current I_{RMS} versus frequency f (for sinusoidal waveforms, $T_A \leq 85^\circ C$, $\Delta T \leq 15^\circ C$)

Lead spacing 22.5 mm

400 V DC/250 V AC

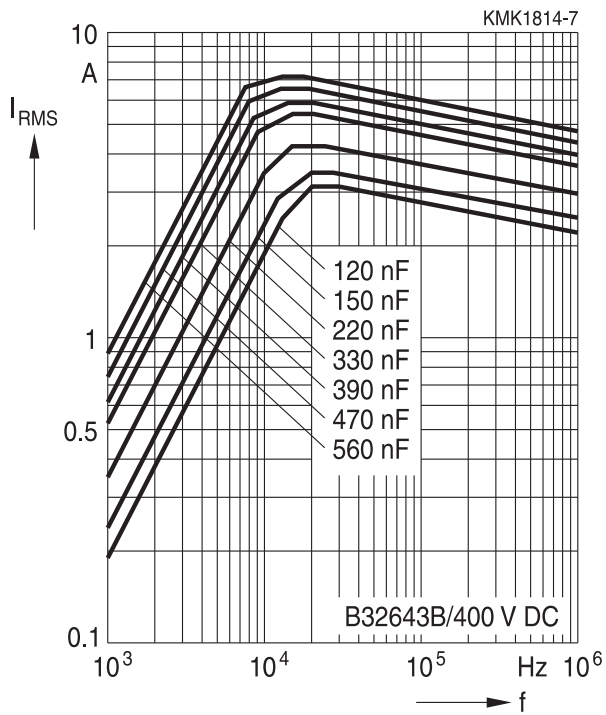

630 V DC/400 V AC

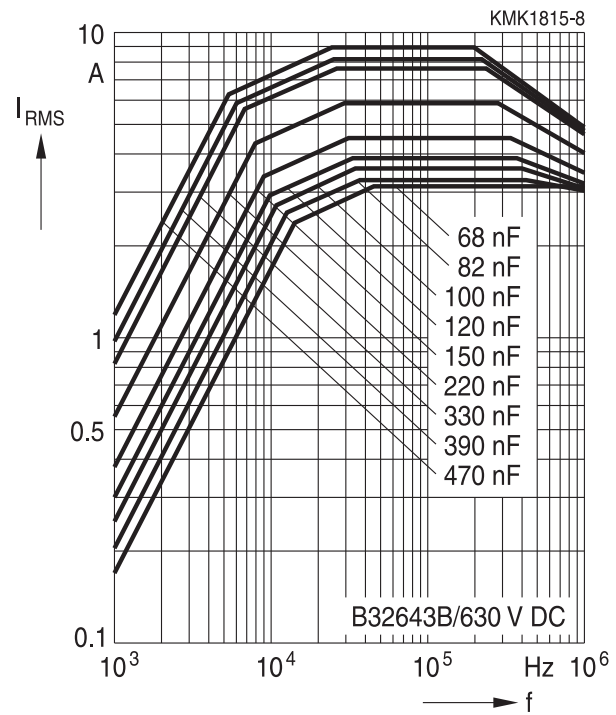

1000 V DC/500 V AC

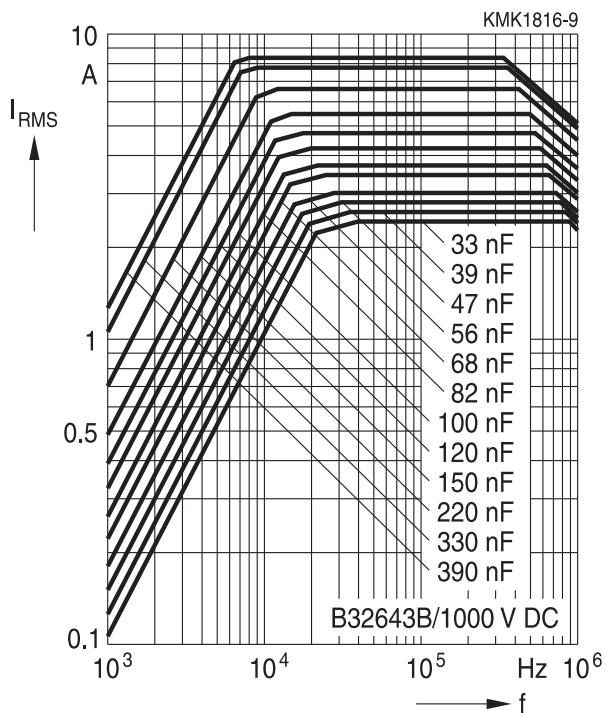

1600 V DC/500 V AC

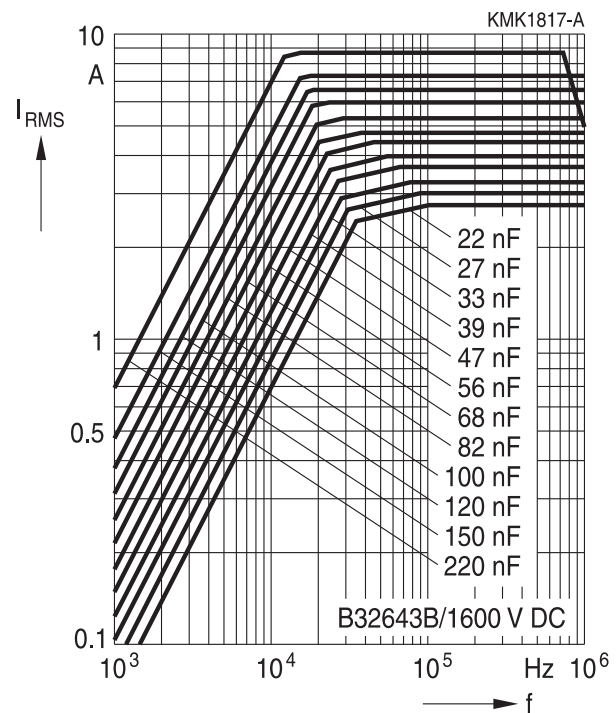

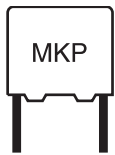

B32641B ... B32643B

High frequency

Permissible current I_{RMS} versus frequency f (for sinusoidal waveforms, $T_A \leq 85\text{ °C}$, $\Delta T \leq 15\text{ °C}$)

Lead spacing 22.5 mm

2000 V DC/500 V AC

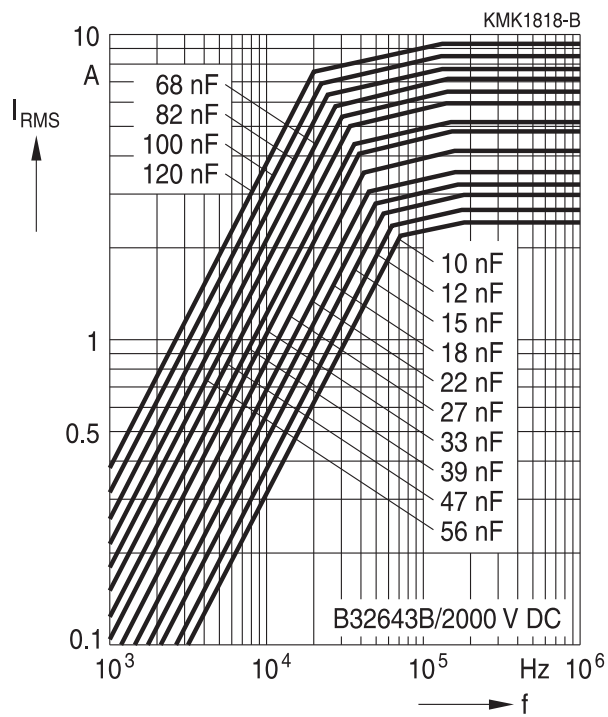

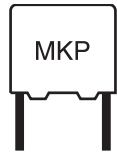

Curves Characteristics (I_{RMS} derating vs temperature)

The operating temperature, which is the sum of ambient temperature and self-heating, shall not exceed the max operation temperature assure this, a derating in the I_{RMS} shall be applied as follows:

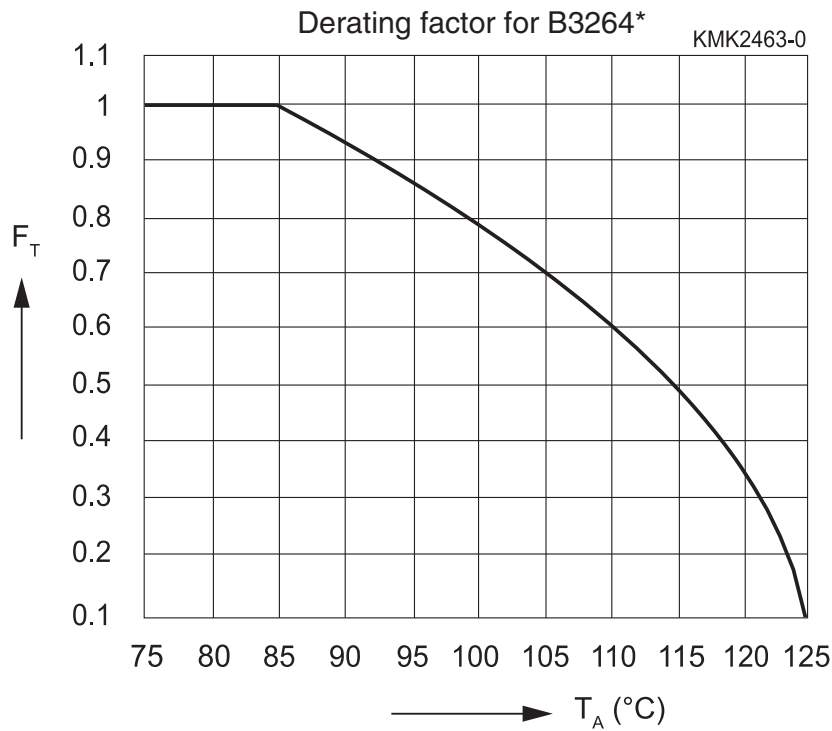

Maximum I_{RMS} current as function of the ambient temperature: $I_{RMS}(T_A) = F_T \cdot I_{RMS}(85\text{ °C})$

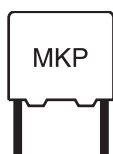

B32641B ... B32643B

High frequency

Testing and Standards

Test and IEC reference	Conditions of test	Failure criteria			
		Visible damages	$ \Delta C/C $	$\tan \delta$ (100kHz)	R_{ins}
Electrical parameters IEC 60384-16:2005	Capacitance: 1 KHz, 1.0 V Loss factor: 1 KHz, 1.0 V 100 KHz, 1.0V Voltage proof: 1.6 V_R , 1 min Insulation resistance: 500 V, 1 min	Yes		Within specified limits	<100 G Ω
Rapid change of temperature IEC 60384-16:2005	T_A = Lower category temperature T_B = Upper category temperature Five cycles, duration t = 30 min	Yes	–	–	–
Vibration IEC 60384-16:2005	10 Hz ~ 500 Hz 0.75 mm 6 hours per axe	Yes	–	–	–
Bump IEC 60384-16:2005	390 m/s ² 6 ms 3 axes, total number of bumps: 4000	Yes	> 2%	> upper limit value	< 50% of min. as-delivered value
Climatic sequence IEC 60384-1:2016	Dry heat: 16 hours Damp heat, one cycle Test Aa 2 hours	Yes	> 2%	> 1.5 × upper limit value	< 50% of min. as-delivered value
Damp heat, steady state IEC 60384-16:2005	40 °C / 93% relative humidity / 56 days	Yes	> 3%	> 1.5 × upper limit value	< 50% of min. as-delivered value
Advanced biased humidity	60 °C / 95% relative humidity with $V_{R,DC}$ / 1000 hours	Yes	> 5%	> 1.5 × upper limit value	< 50% of min. as-delivered value
Resistance to soldering heat IEC 60068-2-20:2008	Solder bath at +260 °C ±5°C	Yes	> 2%	> upper limit value	< 50% of min. as-delivered value
Endurance IEC 60384-16:2005	85 °C / 1.25 V_R / 1000 hours	Yes	> 5%	> 1.5 × upper limit value	< 50% of min. as-delivered value
Charge and discharge IEC 60384-16:2005	10000 pulses and with 2 times dV/dt according to detail specification	Yes	> 3%	> 1.5 × upper limit value	< 50% of min. as-delivered value

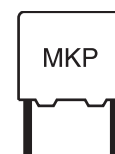

Mounting guidelines

1 Soldering

1.1 Solderability of leads

The solderability of terminal leads is tested to IEC 60068-2-20:2008, test Ta, method 1.

Before a solderability test is carried out, terminals are subjected to accelerated ageing (to IEC 60068-2-2:2007, test Ba: 4 h exposure to dry heat at 155 °C). Since the ageing temperature is far higher than the upper category temperature of the capacitors, the terminal wires should be cut off from the capacitor before the ageing procedure to prevent the solderability being impaired by the products of any capacitor decomposition that might occur.

Solder bath temperature	235 ±5 °C
Soldering time	2.0 ±0.5 s
Immersion depth	2.0 +0/−0.5 mm from capacitor body or seating plane
Evaluation criteria:	
Visual inspection	Wetting of wire surface by new solder ≥90%, free-flowing solder

1.2 Resistance to soldering heat

Resistance to soldering heat is tested to IEC 60068-2-20:2008, test Tb, method 1.

Conditions:

Series	Solder bath temperature	Soldering time
MKT boxed (except 2.5 × 6.5 × 7.2 mm) coated uncoated (lead spacing >10 mm)	260 ±5 °C	10 ±1 s
MFP MKP (lead spacing >7.5 mm)		
MKT boxed (case 2.5 × 6.5 × 7.2 mm)		5 ±1 s
MKT (lead spacing ≤7.5 mm)		<4 s
MKT uncoated (lead spacing ≤10 mm) insulated (B32559)		recommended soldering profile for MKT uncoated (lead spacing ≤ 10 mm) and insulated (B32559)

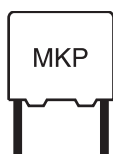

B32641B ... B32643B

High frequency

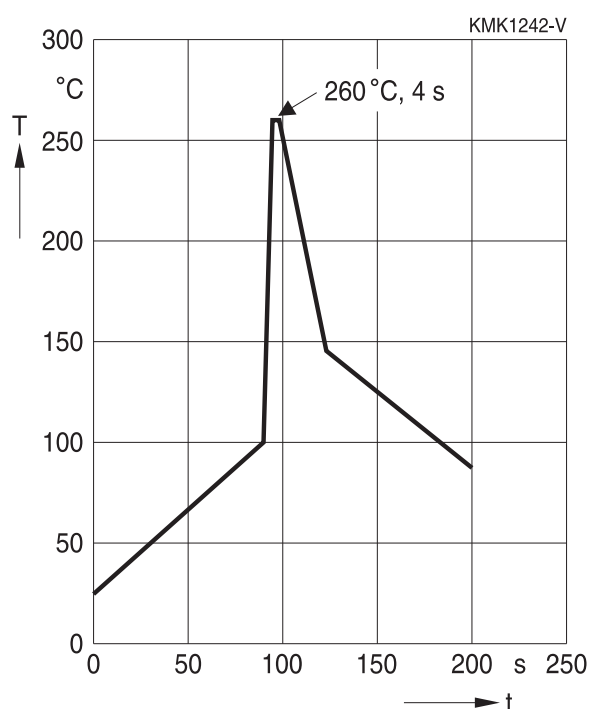

Immersion depth	2.0 +0/−0.5 mm from capacitor body or seating plane
Shield	Heat-absorbing board, (1.5 ±0.5) mm thick, between capacitor body and liquid solder
Evaluation criteria:	
Visual inspection	No visible damage
$\Delta C/C_0$	2% for MKT/MKP/MFP 5% for EMI suppression capacitors
$\tan \delta$	As specified in sectional specification

1.3 General notes on soldering

Permissible heat exposure loads on film capacitors are primarily characterized by the upper category temperature T_{max} . Long exposure to temperatures above this type-related temperature limit can lead to changes in the plastic dielectric and thus change irreversibly a capacitor's electrical characteristics. For short exposures (as in practical soldering processes) the heat load (and thus the possible effects on a capacitor) will also depend on other factors like:

- Pre-heating temperature and time
- Forced cooling immediately after soldering
- Terminal characteristics:
diameter, length, thermal resistance, special configurations (e.g. crimping)
- Height of capacitor above solder bath
- Shadowing by neighboring components
- Additional heating due to heat dissipation by neighboring components
- Use of solder-resist coatings

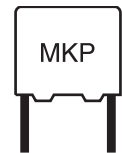

The overheating associated with some of these factors can usually be reduced by suitable countermeasures. For example, if a pre-heating step cannot be avoided, an additional or reinforced cooling process may possibly have to be included.

Recommendations

As a reference, the recommended wave soldering profile for our film capacitors is as follows:

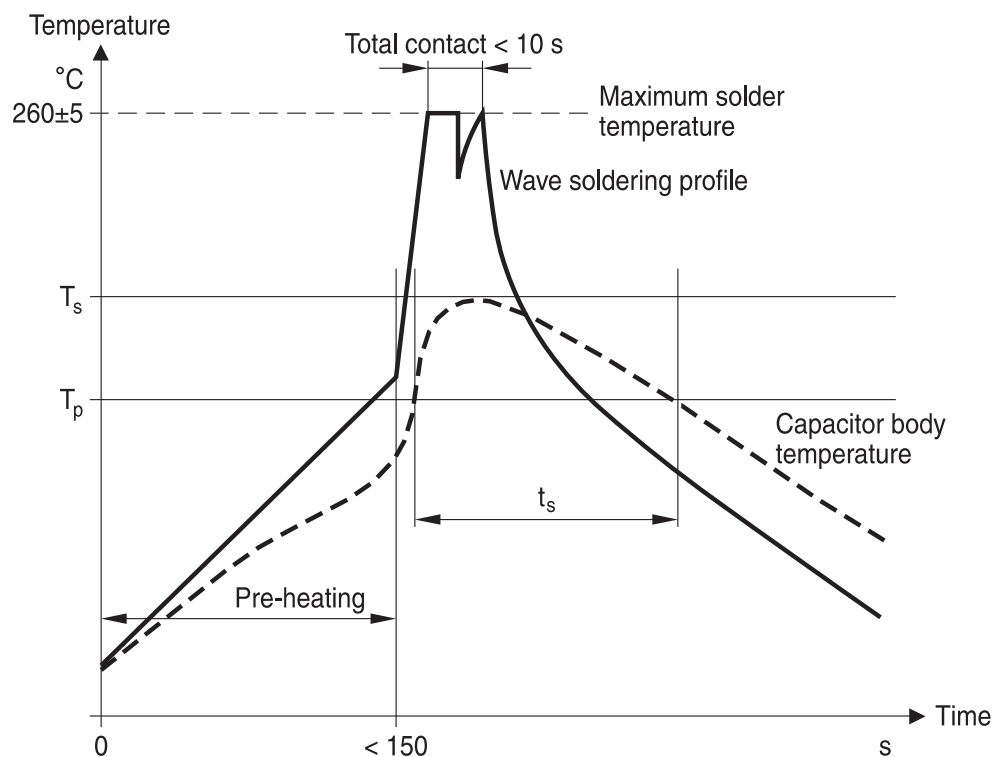

T_s : Capacitor body maximum temperature at wave soldering

T_p : Capacitor body maximum temperature at pre-heating

KMK1745-A-E

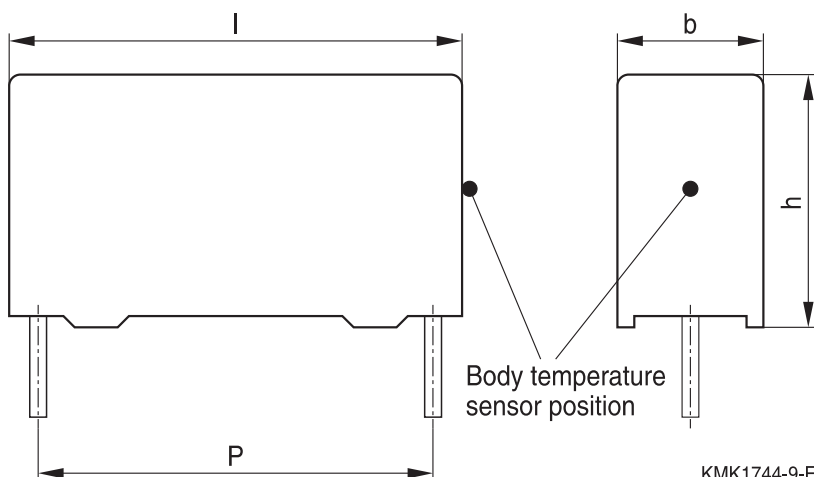

KMK1744-9-E

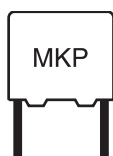

B32641B ... B32643B

High frequency

Body temperature should follow the description below:

- MKP capacitor
 - During pre-heating: $T_p \leq 110 \text{ }^\circ\text{C}$
 - During soldering: $T_s \leq 120 \text{ }^\circ\text{C}$, $t_s \leq 45 \text{ s}$
- MKT capacitor
 - During pre-heating: $T_p \leq 125 \text{ }^\circ\text{C}$
 - During soldering: $T_s \leq 160 \text{ }^\circ\text{C}$, $t_s \leq 45 \text{ s}$

When SMD components are used together with leaded ones, the film capacitors should not pass into the SMD adhesive curing oven. The leaded components should be assembled after the SMD curing step.

Leaded film capacitors are not suitable for reflow soldering.

In order to ensure proper conditions for manual or selective soldering, the body temperature of the capacitor (T_s) must be $\leq 120 \text{ }^\circ\text{C}$.

One recommended condition for manual soldering is that the tip of the soldering iron should be $< 360 \text{ }^\circ\text{C}$ and the soldering contact time should be no longer than 3 seconds.

For uncoated MKT capacitors with lead spacings $\leq 10 \text{ mm}$ (B32560/B32561) the following measures are recommended:

- pre-heating to not more than $110 \text{ }^\circ\text{C}$ in the preheater phase
- rapid cooling after soldering

Please refer to our Film Capacitors Data Book in case more details are needed.

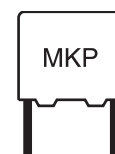

Cautions and warnings

- Do not exceed the upper category temperature (UCT).
- Do not apply any mechanical stress to the capacitor terminals.
- Avoid any compressive, tensile or flexural stress.
- Do not move the capacitor after it has been soldered to the PC board.
- Do not pick up the PC board by the soldered capacitor.
- Do not place the capacitor on a PC board whose PTH hole spacing differs from the specified lead spacing.
- Do not exceed the specified time or temperature limits during soldering.
- Avoid external energy inputs, such as fire or electricity.
- Avoid overload of the capacitors.
- Consult us if application is with severe temperature and humidity condition.
- There are no serviceable or repairable parts inside the capacitor. Opening the capacitor or any attempts to open or repair the capacitor will void the warranty and liability of TDK Electronics.
- Please note that the standards referred to in this publication may have been revised in the meantime.

The table below summarizes the safety instructions that must always be observed. A detailed description can be found in the relevant sections of the chapters "General technical information" and "Mounting guidelines".

Topic	Safety information	Reference chapter "General technical information"
Storage conditions	Make sure that capacitors are stored within the specified range of time, temperature and humidity conditions.	4.5 "Storage conditions"
Flammability	Avoid external energy, such as fire or electricity (passive flammability), avoid overload of the capacitors (active flammability) and consider the flammability of materials.	5.3 "Flammability"
Resistance to vibration	Do not exceed the tested ability to withstand vibration. The capacitors are tested to IEC 60068-2-6:2007. TDK Electronics offers film capacitors specially designed for operation under more severe vibration regimes such as those found in automotive applications. Consult our catalog "Film Capacitors for Automotive Electronics".	5.2 "Resistance to vibration"

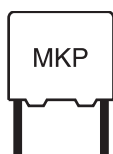

B32641B ... B32643B

High frequency

Topic	Safety information	Reference chapter "Mounting guidelines"
Soldering	Do not exceed the specified time or temperature limits during soldering.	1 "Soldering"
Cleaning	Use only suitable solvents for cleaning capacitors.	2 "Cleaning"
Embedding of capacitors in finished assemblies	When embedding finished circuit assemblies in plastic resins, chemical and thermal influences must be taken into account. Caution: Consult us first, if you also wish to embed other uncoated component types!	3 "Embedding of capacitors in finished assemblies"

Display of ordering codes for TDK Electronics products

The ordering code for one and the same product can be represented differently in data sheets, data books, other publications, on the company website, or in order-related documents such as shipping notes, order confirmations and product labels. The varying representations of the ordering codes are due to different processes employed and do not affect the specifications of the respective products.

Detailed information can be found on the Internet under www.tdk-electronics.tdk.com/orderingcodes.

Correlation of data sheet values and modelling tool outputs

Data sheet values and results of design tools may deviate as they have not been derived in the same context.

While data sheets show individual parameter statements without considering a possible dependency to other parameters. Tools model a complete given scenario as input and processed inside the tool.

Furthermore as we constantly strive to improve our models, the results of tools can change over time and be a non-binding indication only.

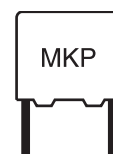
Symbols and terms

Symbol	English	German
α	Heat transfer coefficient	Wärmeübergangszahl
α_C	Temperature coefficient of capacitance	Temperaturkoeffizient der Kapazität
A	Capacitor surface area	Kondensatoroberfläche
β_C	Humidity coefficient of capacitance	Feuchtekoeffizient der Kapazität
C	Capacitance	Kapazität
C_R	Rated capacitance	Nennkapazität
ΔC	Absolute capacitance change	Absolute Kapazitätsänderung
$\Delta C/C$	Relative capacitance change (relative deviation of actual value)	Relative Kapazitätsänderung (relative Abweichung vom Ist-Wert)
$\Delta C/C_R$	Capacitance tolerance (relative deviation from rated capacitance)	Kapazitätstoleranz (relative Abweichung vom Nennwert)
dt	Time differential	Differentielle Zeit
Δt	Time interval	Zeitintervall
ΔT	Absolute temperature change (self-heating)	Absolute Temperaturänderung (Selbsterwärmung)
$\Delta \tan \delta$	Absolute change of dissipation factor	Absolute Änderung des Verlustfaktors
ΔV	Absolute voltage change	Absolute Spannungsänderung
dV/dt	Time differential of voltage function (rate of voltage rise)	Differentielle Spannungsänderung (Spannungsflankensteilheit)
$\Delta V/\Delta t$	Voltage change per time interval	Spannungsänderung pro Zeitintervall
E	Activation energy for diffusion	Aktivierungsenergie zur Diffusion
ESL	Self-inductance	Eigeninduktivität
ESR	Equivalent series resistance	Ersatz-Serienwiderstand
f	Frequency	Frequenz
f_1	Frequency limit for reducing permissible AC voltage due to thermal limits	Grenzfrequenz für thermisch bedingte Reduzierung der zulässigen Wechselspannung
f_2	Frequency limit for reducing permissible AC voltage due to current limit	Grenzfrequenz für strombedingte Reduzierung der zulässigen Wechselspannung
f_r	Resonant frequency	Resonanzfrequenz
F_D	Thermal acceleration factor for diffusion	Therm. Beschleunigungsfaktor zur Diffusion
F_T	Derating factor	Deratingfaktor
i	Current (peak)	Stromspitze
I_C	Category current (max. continuous current)	Kategoriestrom (max. Dauerstrom)

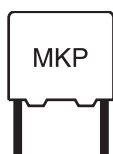

B32641B ... B32643B

High frequency

Symbol	English	German
I_{RMS}	(Sinusoidal) alternating current, root-mean-square value	(Sinusförmiger) Wechselstrom
i_z	Capacitance drift	Inkonstanz der Kapazität
k_0	Pulse characteristic	Impuls Kennwert
L_S	Series inductance	Serieninduktivität
λ	Failure rate	Ausfallrate
λ_0	Constant failure rate during useful service life	Konstante Ausfallrate in der Nutzungsphase
λ_{test}	Failure rate, determined by tests	Experimentell ermittelte Ausfallrate
P_{diss}	Dissipated power	Abgegebene Verlustleistung
P_{gen}	Generated power	Erzeugte Verlustleistung
Q	Heat energy	Wärmeenergie
ρ	Density of water vapor in air	Dichte von Wasserdampf in Luft
R	Universal molar constant for gases	Allg. Molarkonstante für Gas
R	Ohmic resistance of discharge circuit	Ohmscher Widerstand des Entladekreises
R_i	Internal resistance	Innenwiderstand
R_{ins}	Insulation resistance	Isolationswiderstand
R_P	Parallel resistance	Parallelwiderstand
R_S	Series resistance	Serienwiderstand
S	severity (humidity test)	Schärfegrad (Feuchtetest)
t	Time	Zeit
T	Temperature	Temperatur
τ	Time constant	Zeitkonstante
$\tan \delta$	Dissipation factor	Verlustfaktor
$\tan \delta_D$	Dielectric component of dissipation factor	Dielektrischer Anteil des Verlustfaktors
$\tan \delta_P$	Parallel component of dissipation factor	Parallelanteil des Verlustfaktors
$\tan \delta_S$	Series component of dissipation factor	Serienanteil des Verlustfaktors
T_A	Temperature of the air surrounding the component	Temperatur der Luft, die das Bauteil umgibt
T_{max}	Upper category temperature	Obere Kategorietemperatur
T_{min}	Lower category temperature	Untere Kategorietemperatur
t_{OL}	Operating life at operating temperature and voltage	Betriebszeit bei Betriebstemperatur und -spannung
T_{op}	Operating temperature, $T_A + \Delta T$	Betriebstemperatur, $T_A + \Delta T$
T_R	Rated temperature	Nenntemperatur
T_{ref}	Reference temperature	Referenztemperatur
t_{SL}	Reference service life	Referenz-Lebensdauer

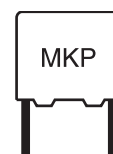

Symbol	English	German
V_{AC}	AC voltage	Wechselspannung
V_C	Category voltage	Kategorie spannung
$V_{C,RMS}$	Category AC voltage	(Sinusförmige) Kategorie-Wechselspannung
V_{CD}	Corona-discharge onset voltage	Teilentlade-Einsatzspannung
V_{ch}	Charging voltage	Ladespannung
V_{DC}	DC voltage	Gleichspannung
V_{FB}	Fly-back capacitor voltage	Spannung (Flyback)
V_i	Input voltage	Eingangsspannung
V_o	Output voltage	Ausgangsspannung
V_{op}	Operating voltage	Betriebsspannung
V_p	Peak pulse voltage	Impuls-Spitzen spannung
V_{pp}	Peak-to-peak voltage Impedance	Spannungshub
V_R	Rated voltage	Nennspannung
\hat{V}_R	Amplitude of rated AC voltage	Amplitude der Nenn-Wechselspannung
V_{RMS}	(Sinusoidal) alternating voltage, root-mean-square value	(Sinusförmige) Wechselspannung
V_{SC}	S-correction voltage	Spannung bei Anwendung "S-correction"
V_{sn}	Snubber capacitor voltage	Spannung bei Anwendung "Beschaltung"
Z	Impedance	Scheinwiderstand
e	Lead spacing	Rastermaß

Important notes

The following applies to all products named in this publication:

1. Some parts of this publication contain **statements about the suitability of our products for certain areas of application**. These statements are based on our knowledge of typical requirements that are often placed on our products in the areas of application concerned. We nevertheless expressly point out **that such statements cannot be regarded as binding statements about the suitability of our products for a particular customer application**. As a rule, we are either unfamiliar with individual customer applications or less familiar with them than the customers themselves. For these reasons, it is always ultimately incumbent on the customer to check and decide whether a product with the properties described in the product specification is suitable for use in a particular customer application.
2. We also point out that **in individual cases, a malfunction of electronic components or failure before the end of their usual service life cannot be completely ruled out in the current state of the art, even if they are operated as specified**. In customer applications requiring a very high level of operational safety and especially in customer applications in which the malfunction or failure of an electronic component could endanger human life or health (e.g. in accident prevention or lifesaving systems), it must therefore be ensured by means of suitable design of the customer application or other action taken by the customer (e.g. installation of protective circuitry or redundancy) that no injury or damage is sustained by third parties in the event of malfunction or failure of an electronic component.
3. **The warnings, cautions and product-specific notes must be observed.**
4. In order to satisfy certain technical requirements, **some of the products described in this publication may contain substances subject to restrictions in certain jurisdictions (e.g. because they are classed as hazardous)**. Useful information on this will be found in our Material Data Sheets on the Internet (www.tdk-electronics.tdk.com/material). Should you have any more detailed questions, please contact our sales offices.
5. We constantly strive to improve our products. Consequently, **the products described in this publication may change from time to time**. The same is true of the corresponding product specifications. Please check therefore to what extent product descriptions and specifications contained in this publication are still applicable before or when you place an order. We also **reserve the right to discontinue production and delivery of products**. Consequently, we cannot guarantee that all products named in this publication will always be available. The aforementioned does not apply in the case of individual agreements deviating from the foregoing for customer-specific products.
6. Unless otherwise agreed in individual contracts, **all orders are subject to our General Terms and Conditions of Supply**.

Important notes

7. **Our manufacturing sites serving the automotive business apply the IATF 16949 standard.** The IATF certifications confirm our compliance with requirements regarding the quality management system in the automotive industry. Referring to customer requirements and customer specific requirements (“CSR”) TDK always has and will continue to have the policy of respecting individual agreements. Even if IATF 16949 may appear to support the acceptance of unilateral requirements, we hereby like to emphasize that **only requirements mutually agreed upon can and will be implemented in our Quality Management System.** For clarification purposes we like to point out that obligations from IATF 16949 shall only become legally binding if individually agreed upon.
8. The trade names EPCOS, CarXield, CeraCharge, CeraDiode, CeraLink, CeraPad, CeraPlas, CSMP, CTVS, DeltaCap, DigiSiMic, ExoCore, FilterCap, FormFit, LeaXield, MiniBlue, MiniCell, MKD, MKK, ModCap, MotorCap, PCC, PhaseCap, PhaseCube, PhaseMod, PhiCap, PowerHap, PQSine, PQvar, SIFERRIT, SIFI, SIKOREL, SilverCap, SIMDAD, SiMic, SIMID, SineFormer, SIOV, ThermoFuse, WindCap, XieldCap are **trademarks registered or pending** in Europe and in other countries. Further information will be found on the Internet at www.tdk-electronics.tdk.com/trademarks.

Release 2020-06