



# MAX11068 Evaluation System

## General Description

The MAX11068 evaluation kit (EV kit) demonstrates the capabilities of the MAX11068 advanced smart battery-pack controller. The EV kit PCB is made up of two boards, each containing nearly identical MAX11068 circuits. The left side of the EV kit is referenced as side (A) and the right side is referenced as side (B). The two-boards-in-one design provides a simple demonstration of the MAX11068's SMBus™ ladder capability. Additional vertical headers allow for the connection of multiple EV kits, supporting the maximum 31-device ladder capability of the device's I<sup>2</sup>C bus system.

Integrated into the EV kit design are two MAX11080 12-channel high-voltage battery-pack fault monitors. The MAX11080 ICs work in conjunction with the MAX11068 ICs, providing redundant overvoltage and undervoltage monitoring.

The MAX11068 evaluation system (EV system) includes the MAX11068 EV kit and the MINIQUSB command module. The MINIQUSB provides an I<sup>2</sup>C interface to a PC. The supplied command module allows the kit to be evaluated with the MAX11068 EV kit software that can be downloaded from [www.maxim-ic.com/evkitsoftware](http://www.maxim-ic.com/evkitsoftware).

## Features

- ◆ On-Board Protection Fuse (Optional)
- ◆ Battery-Cell String Emulation
- ◆ I<sup>2</sup>C interface (MINIQUSB Connectivity)
- ◆ Windows® 2000-, Windows XP®, and Windows Vista® (32-Bit)-Compatible Software
- ◆ Fully Assembled and Tested

## Ordering Information

PART	TYPE
MAX11068EVMINIQU+	EV System

+Denotes lead(Pb)-free and RoHS compliant.

## Component Lists

### MAX11068 EV System

PART	QTY	DESCRIPTION
MAX11068EVKIT+	1	MAX11068 EV kit
MINIQUSB+	1	Maxim command module

Evaluates: MAX11068

SMBus is a trademark of Intel Corp.

Windows, Windows XP, and Windows Vista are registered trademarks of Microsoft Corp.



# MAX11068 Evaluation System

Evaluates: MAX11068

## Component Lists (continued)

### MAX11068 EV Kit

DESIGNATION	QTY	DESCRIPTION
ALRMINC_A, ALRMINC_B, ALRMINCA, ALRMINCB, ALRMLA1, ALRMLB1, ALRMOUTCA1, ALRMOUTCB1, ALRMU_A, ALRMU_B, ALRMUA, ALRMUB, GNDLA, GNDLB, GNDU1, GNDU3, REFA, REFB, SCLLA1, SCLLB1, SCLU_A, SCLU_B, SCLUA, SCLUB, SDALA1, SDALB1, SDAU_A, SDAU_B, SDAUA, SDAUB, SHDNINA1, SHDNINB1, SHDNINCA1, SHDNINCB1, TP2, TP3, VAAA, VAAB, VAACA, VAACB, VDDCPA, VDDCPB, VDDPCPA, VDDPCPB	44	Miniature test points
C1, C3, C25, C27, C40, C43, C44, C48, C49, C101, C103, C125, C127, C140, C143, C144, C148, C149	18	1 $\mu$ F $\pm$ 10%, 16V X7R ceramic capacitors (0603) Murata GRM188R71C105K TDK C1608X7R1C105K
C2, C102	2	0.47 $\mu$ F $\pm$ 10%, 6.3V X7R ceramic capacitors (0603) Murata GRM188R70J474KA TDK C1608X7R1C474K (16V)
C4, C104	0	Not installed, ceramic capacitors (2220)

DESIGNATION	QTY	DESCRIPTION
C5, C105	2	1 $\mu$ F $\pm$ 10%, 100V X7R ceramic capacitors (1206) Murata GRM31CR72A105KA TDK C3216X7R2A105K
C6–C17, C24, C28– C39, C46, C54, C55, C106–C117, C124, C128–C139, C146, C154, C155	56	0.1 $\mu$ F $\pm$ 10%, 100V X7R ceramic capacitors (0603) Murata GRM188R72A104KA
C18, C19, C20, C118, C119, C120	6	100pF $\pm$ 5%, 50V C0G ceramic capacitors (0402) Murata GRM1555C1H101J TDK C1005C0G1H101J
C21, C22, C23, C41, C121, C122, C123, C141	8	3300pF, 630V ceramic capacitors (1206) TDK C3216C0G2J332J ( $\pm$ 5%, C0G) Murata GRM31BR72J332KW ( $\pm$ 10%, X7R) Murata GCJ31BR72J332K ( $\pm$ 10%, X7R, automotive grade)
C26, C126	2	3.3 $\mu$ F $\pm$ 10%, 16V X7R ceramic capacitors (0805) Murata GRM21BR71C335K
C42, C142	2	0.01 $\mu$ F $\pm$ 10%, 100V X7R ceramic capacitors (0603) Murata GRM188R72A103KA
C45, C145	2	0.15 $\mu$ F $\pm$ 10%, 10V X7R ceramic capacitors (0603) Murata GRM188R71A154KA TDK C1608X7R1E154K (50V)
C47, C50, C51, C147, C150, C151	0	Not installed, ceramic capacitors—short (PC trace) (0603)
C52, C53, C152, C153	4	68000pF $\pm$ 5%, 16V X7R ceramic capacitors (0603) Murata GRM188R71C683K

# MAX11068 Evaluation System

## Component Lists (continued)

### MAX11068 EV Kit (continued)

DESIGNATION	QTY	DESCRIPTION
D1, D7, D15, D16, D33, D34, D101, D107, D115, D116, D133, D134	0	Not installed, zener diodes (SOT23)
D2, D6, D102, D106	4	5.6V zener diodes (SOT23) Fairchild MMBZ5232B Diodes Inc. MMBZ5232B-7-F
D3, D9, D103, D109	4	1A, 100V diodes (SMA) Fairchild S1B Diodes Inc. US1B-13-F
D4, D8, D104, D108	4	70V zener transient-voltage suppressors (SMC)
D5, D12, D13, D105, D112, D113	6	Signal diodes (SOT23) Central Semi CMPD1001
D10, D110	0	Not installed, signal diodes (SOD123)
D11, D14, D111, D114	4	100V small-signal diodes (SOD123) Fairchild MMSD4448 Diodes Inc. BAY19W-7-F
D17, D18, D19, D26–D29, D117, D118, D119, D126–D129	0	Not installed, zener diodes (SOD123)
D20–D25, D30, D120–D125, D130	0	Not installed, zener diodes (SOD123)
D31, D131	2	13V zener diodes (SMA) Central Semi CMZ5928B
D32, D35, D132, D135	4	1A rectifier diodes (SMA) Fairchild S1A
D36, D37, D136, D137	4	100V Schottky diodes (SOT23) STMicro BAT46FILM Vishay BAS70-00-V
F0, F14, F100, F114	4	22Ω resistors (axial) Optional: PolySwitch®, PTC resettable fuse (radial)
F1–F13, F101–F113	26	0Ω resistors (1206) Optional: 250mA fast-acting chip fuse (1206)

DESIGNATION	QTY	DESCRIPTION
F15, F16, F115, F116	0	Not installed, resettable fuses (radial)
GPIO0, GPIO1, GPIO2, GPIO100, GPIO101, GPIO102	6	Multipurpose test points
J1, J2, J101, J102	4	20-pin (2 x 10) dual-row headers, 0.1in centers
J3, J103	2	2 x 10 right-angle receptacles
J4–J7, J104–J107	0	Not installed, 20-pin headers, 0.1in centers
J8, J108	2	13-pin headers, 0.1in centers
JU0–JU11, JU12, JU20, JU21, JU24, JU25, JU26, JU31, JU32, JU100–JU111, JU112, JU120, JU121, JU124, JU125, JU126, JU131, JU132	40	2-pin headers, 0.1in centers
JU13–JU19, JU28, JU113–JU119, JU128	16	3-pin headers, 0.1in centers
JU22, JU23, JU29, JU30, JU122, JU123, JU129, JU130	0	Not installed, 2-pin headers, 0.1in centers
LED1, LED2, LED101, LED102	4	Surface-mount LEDs (0805)
P2	0	Not installed, RJ-11 jack (R/A 6 positions/6 contacts)
P3, P103	2	2 x 13-pin shrouded headers, 0.1in centers
Q1–Q12, Q101–Q112	0	Not installed, npn bipolar transistors (SOT23)
R1, R101	2	0Ω resistors (0603)
R2, R102	2	100kΩ ±5% resistors (0603)
R3–R15, R103–R115	26	10Ω ±1%, 1/2W resistors (1210)

Evaluates: MAX11068

PolySwitch is a registered trademark of Tyco International Ltd.

# MAX11068 Evaluation System

Evaluates: MAX11068

## Component Lists (continued)

### MAX11068 EV Kit (continued)

DESIGNATION	QTY	DESCRIPTION
R16–R28, R116–R128	0	Not installed, resistors—short (PC trace) (0805)
R29, R30, R129, R130	4	10k $\Omega$ $\pm$ 1% resistors (0402)
R31, R32, R33, R35, R36, R75, R131, R132, R133, R135, R136, R175	12	150k $\Omega$ $\pm$ 5% resistors (0402)
R34, R74, R134, R174	0	Not installed, resistors (0402)
R37, R137	2	200k $\Omega$ $\pm$ 5% resistors (0603)
R38, R41, R138, R141	4	330k $\Omega$ $\pm$ 5%, 1/8W resistors (0805)
R39, R86, R139, R186	4	1k $\Omega$ $\pm$ 5% resistors (0402)
R40, R140	2	20k $\Omega$ $\pm$ 5% resistors (0402)
R42–R53, R142–R153	24	2k $\Omega$ $\pm$ 0.1% resistors (0603)
R54–R57, R59, R80–R85, R87–R90, R154–R157, R159, R180–R185, R187–R190	30	0 $\Omega$ resistors (0402)

DESIGNATION	QTY	DESCRIPTION
R58, R79, R158, R179	4	22 $\Omega$ $\pm$ 5% resistors (0402)
R60–R71, R160–R171	24	10k $\Omega$ $\pm$ 1%, 1/4W resistors (1206)
R72, R172	2	0 $\Omega$ resistors (1206)
R73, R173	2	200k $\Omega$ $\pm$ 5% resistors (0402)
R76, R176	2	4.99k $\Omega$ $\pm$ 1% resistors (1206)
R77, R177	2	20k $\Omega$ $\pm$ 5% resistors (0603)
R91, R92, R191, R192	4	150 $\Omega$ $\pm$ 5% resistors (0603)
SW1, SW101	2	12-position SPST DIP switches
SW21, SW22, SW121, SW122	4	7-position SPST DIP switches
U1, U101	2	Daisy-chainable analog front-ends (38 TSSOP) MAX11068GUU+
U2, U102	2	High-voltage battery-pack fault monitors (38 TSSOP) MAX11080GUU+
—	56	Shunts
—	1	PCB: MAX11068 EVALUATION KIT+

## Component Suppliers

SUPPLIER	PHONE	WEBSITE
Central Semiconductor Corp.	631-435-1110	www.centralsemi.com
Diodes Incorporated	805-446-4800	www.diodes.com
Fairchild Semiconductor	888-522-5372	www.fairchildsemi.com
Murata Electronics North America, Inc.	770-436-1300	www.murata-northamerica.com
STMicroelectronics	408-452-8585	www.us.st.com
TDK Corp.	847-803-6100	www.component.tdk.com
Vishay	402-563-6866	www.vishay.com

**Note:** Indicate that you are using the MAX11068 when contacting these component suppliers.

# MAX11068 Evaluation System

## MAX11068 EV Kit Files

FILE	DESCRIPTION
INSTALL.EXE	Installs the EV kit files on your computer
MAX11068.EXE	Application program
11068config.csv	MAX11068 GUI configuration file
Revision History.txt	Software revision history (read only)
FTD2XX.INF	USB device driver file
UNINST.INI	Uninstalls the EV kit software
USB_Driver_Help.PDF	USB driver installation help file

## Quick Start

### Recommended Equipment

- MAX11068 EV system
  - MAX11068 EV kit
  - MINIUSB+ command module
  - MINIUSB board
  - MINIUSB-XHV board
- 6V to 60V dual DC power supplies (refer to the MAX11068 and MAX11080 IC data sheets for recommended operating ranges)
- User-supplied Windows 2000, Windows XP, or Windows Vista PC with a spare USB port

**Note:** In the following sections, software-related items are identified by bolding. Text in **bold** refers to items directly from the EV kit software. Text in **bold and underlined** refers to items from the Windows operating system.

### Procedure

The EV kit is fully assembled and tested. Follow the steps below to verify board operation. **Caution: Do not plug in the power adapter until all connections are completed.**

- 1) Visit [www.maxim-ic.com/evkitsoftware](http://www.maxim-ic.com/evkitsoftware) to download the latest version of the EV kit software, 11068Rxx.ZIP. Save the EV kit software to a temporary folder and uncompress the ZIP file.
- 2) Install the EV kit software on your computer by running the INSTALL.EXE program inside the temporary folder. The program files are copied and icons are created in the Windows **Start | Programs** menu.
- 3) Connect the MINIUSB board to the MINIUSB-XHV board.
- 4) Connect the USB cable from the PC to the MINIUSB board. A **Building Driver Database** window pops up in addition to a **New Hardware Found** message if this is the first time the EV kit board is connected

to the PC. If a window is not seen that is similar to the one described above after 30s, remove the USB cable from the MINIUSB and reconnect it. Administrator privileges are required to install the USB device driver on Windows 2000, Windows XP, and Windows Vista.

- 5) Follow the directions of the **Add New Hardware Wizard** to install the USB device driver. Choose the **Search for the best driver for your device** option. Specify the location of the device driver to be **C:\Program Files\MAX11068** (default installation directory) using the **Browse** button. Refer to the USB\_Driver\_Help.PDF document included with the software for additional information.
- 6) Ensure that all jumper shunts are installed in the default positions, as shown in Table 1.
- 7) Verify that all switches are configured, as shown in Table 2.
- 8) Ensure that a ribbon cable is connected between headers J2 and J101.
- 9) Configure the DC power supplies for 18V each. The power supplies should be isolated. Refer to the MAX11068 and MAX11080 IC data sheets for valid device operating ranges. The MAX11080 also has a minimum per-cell voltage requirement.
- 10) Connect one 18V supply between the PACKA+ and PACKA- PCB pads and the other 18V supply between the PACKB+ and PACKB- PCB pads, respectively.
- 11) Connect the MINIUSB-XHV board's P3 header to the EV kit's J3 header. The boards should be flush with one another.
- 12) Enable both of the DC power supplies.
- 13) Start the EV kit software by opening its icon in the **Start | Programs** menu. The EV kit software main window appears, as shown in Figure 7.

Evaluates: MAX11068

# MAX11068 Evaluation System

- 14) The EV kit software automatically establishes a connection with the EV kit. Once the status bar at the bottom of the window displays **Interface found**, proceed to the next step.
- 15) If checked, uncheck the **SHDN** checkbox.
- 16) Press the **Hello ALL** button.
- 17) Press the **Roll Call** button once it is activated.
- 18) Press the **Set Last Address** button once it is activated.
- 19) Verify that the **Device Addresses (0x01)** grid contains two device addresses and the status bar at the bottom indicates **Initialization Successful**.
- 20) The EV kit is now ready for further evaluation.

## Detailed Description of Software

The MAX11068 EV kit is evaluated in conjunction with the MAX11068 evaluation software. The graphical user interface (GUI) provides a friendly environment for reading and writing to all device registers, as well as executing the seven device commands. The GUI is divided into three sections, **Initialization** group box, register tabs, and command tabs.

The **Initialization** group box provides controls for the HELLOALL, ROLLCALL, and SETLASTADDRESS commands, as well as device-shutdown capability. The command tabs, located in the upper-right section of the GUI, provide controls for executing the WRITEALL, READALL, and STROBEALL commands. This group of tabs also includes a **Device Address** grid that displays

**Table 1. Default Jumper Settings**

JUMPER	SHUNT POSITION
JU0, JU1, JU20, JU24, JU25, JU26, JU100, JU101, JU120, JU124, JU125, JU126, JU128, JU131, JU132	1-2
JU2–JU11, JU12, JU21, JU102–JU112, JU121	On one pin only
JU13, JU16, JU18, JU19, JU113, JU116, JU118, JU119	1-2
JU14, JU15, JU17, JU28, JU114, JU115, JU117	2-3

**Note:** Jumper designators JU27 and JU127 are not used on this EV kit.

the address of each device in the SMBus ladder, a **Communication Log** that displays a summary of bus activity, and a **Short Cuts** tab that provides faster ways of executing useful software functions.

The seven register tabs provide access to all the devices in the SMBus ladder. Each tab includes a grid that is used to display the contents read from the registers. The grid is made of x columns and y rows, where x is the number of registers (shown above each grid) associated with that tab and y is the number of devices in the SMBus ladder. In addition, each tab includes various controls (checkboxes, edit boxes, buttons, labels, etc.) for configuring each device. Refer to the *I<sup>2</sup>C Interface* and *Register Map* sections in the MAX11068 IC data sheet for additional interface and register details.

The software also provides a few functions to facilitate the evaluation process. These include a PEC calculator, the capability to save ADC measurements to file, and the ability to save/load register configurations to/from a file. When evaluating the EV kit, the MAX11068 IC data sheet should also be referenced for additional details.

## System Initialization

The SMBus ladder of the EV kit is initialized using the controls provided in the **Initialization** group box on the EV kit software GUI. The recommended initialization sequence is as follows:

- 1) Verify that jumpers JU12, JU25, and JU26 are configured correctly. See the *Device Startup* section.
- 2) Uncheck the **SHDN** checkbox.

**Table 2. Quick-Start Switch Settings**

SWITCH	SETTING
SW1, SW101	Off (towards the right)
SW21, SW22, SW121, SW122	On (upwards)

**Table 3. HELLOALL Command Byte**

Bit 7	Bit 6	Bit 5	Bit 4	Bit 3	Bit 2	Bit 1	Bit 0
1	1	A0	A1	A2	A3	A4	0



# MAX11068 Evaluation System

- 3) Enter or select the HELLOALL command byte (Table 3) into the combo box adjacent to the **Hello ALL** button.
  - The value entered here contains the address (A[0:4]), least significant bit (LSB) first, of the first device in the SMBus ladder. The A[0:4] value is written to the ADDRESS register of the first device.
  - Refer to the *HELLOALL Command* section in the MAX11068 IC data sheet for additional details.
- 4) Press the **Hello ALL** button. Once this command has been executed the **Roll Call** button is enabled.
- 5) Press the **Roll Call** button to determine the number of MAX11068 devices in the SMBus ladder.
  - This button sends the ROLLCALL command down the I<sup>2</sup>C bus instructing all devices to send both bytes of their ADDRESS register (0x01). The ROLLCALL command consists of a sequence of 3 bytes sent by the host to the first device.
  - When this command sequence is completed, the host determines the address of the last device and the total number of devices in the SMBus ladder. The number of devices is displayed in the **Device Count** edit box.
  - See Table 4 and also refer to the *ROLLCALL Command* section in the MAX11068 IC data sheet for additional details.

The BROADCAST address (B[7:1]) is used by the ROLLCALL command and is by default set to 0x40 (0b0100000). After the first initialization of the SMBus ladder, the BROADCAST address can be changed. Refer to the *Address Byte Encoding* sec-

**Table 4. ROLLCALL Command**

BROADCAST ADDRESS (Write)							
Bit 7	Bit 6	Bit 5	Bit 4	Bit 3	Bit 2	Bit 1	Bit 0
B7	B6	B5	B4	B3	B2	B1	0
ADDRESS REGISTER ADDRESS							
Bit 7	Bit 6	Bit 5	Bit 4	Bit 3	Bit 2	Bit 1	Bit 0
0	0	0	0	0	0	0	1
BROADCAST ADDRESS (Read)							
Bit 7	Bit 6	Bit 5	Bit 4	Bit 3	Bit 2	Bit 1	Bit 0
B7	B6	B5	B4	B3	B2	B1	1

tion in the MAX11068 IC data sheet for complete BROADCAST address details.

Once the address of the last device on the stack is known, the host can issue the SETLASTADDRESS command. The SETLASTADDRESS command should only be issued after the ROLLCALL command has been issued and its sequence is complete.

- 6) Press the **Set Last Address** button.
  - This command writes the address of the last device (LA[4:0]) to the upper 8 bits of each device's 16-bit ADDRESS register. The SETLASTADDRESS command consists of a sequence of 5 bytes sent by the host to the first device.
  - See Table 5 and refer to the *SETLASTADDRESS Command* section in the MAX11068 IC data sheet.

The SMBus ladder has been initialized once all devices have been programmed with the address of the last device. The software is now fully operational and all active devices are configurable. Refer to the *I<sup>2</sup>C/SMBus Ladder Initialization Sequence* section in the MAX11068 IC data sheet for additional initial configuration recommendations.

**Table 5. SETLASTADDRESS Command**

BROADCAST ADDRESS (Write)							
Bit 7	Bit 6	Bit 5	Bit 4	Bit 3	Bit 2	Bit 1	Bit 0
B7	B6	B5	B4	B3	B2	B1	0
ADDRESS REGISTER ADDRESS							
Bit 7	Bit 6	Bit 5	Bit 4	Bit 3	Bit 2	Bit 1	Bit 0
0	0	0	0	0	0	0	1
ADDRESS REGISTER (Upper 8 bits)							
Bit 15	Bit 14	Bit 13	Bit 12	Bit 11	Bit 10	Bit 9	Bit 8
0	0	0	LA4	LA3	LA2	LA1	LA0
ADDRESS REGISTER (Lower 8 bits)							
Bit 7	Bit 6	Bit 5	Bit 4	Bit 3	Bit 2	Bit 1	Bit 0
X	X	X	X	X	X	X	X
PEC BYTE*							
Bit 7	Bit 6	Bit 5	Bit 4	Bit 3	Bit 2	Bit 1	Bit 0
8-bit value generated by the host using the first 4 bytes of this SETLASTADDRESS command sequence							

\*See the *PEC Byte* section.  
X = Don't care.

# MAX11068 Evaluation System

### Grid Initialization

When the SETLASTADDRESS command sequence is complete, the software updates the grids on the **Device Addresses (0x01)** tab and the **Thresholds, Voltage Measurement, AIN/DIAG/FMEA, Alert/Status, Enables, Configuration,** and **Broadcast/Version/Freq** tabs.

### Device Addresses Grid

The **Device Addresses (0x01)** tab is initialized after pressing the **Set Last Address** button. The grid contains the addresses of all the detected devices. Selecting a cell that contains a device address updates the **Active Device** drop-down list. For a two-device ladder with a start address of 0x01, the grid would be displayed as shown in Figure 1.

**Note:** A device's address is contained in the lower byte of its ADDRESS register (bit[5:1]), specified LSB first. A device address of 0x01 (A[4:0]) would be stored in the

device's ADDRESS register as 0xA0 (A[0:4]). This relationship is displayed in the **Active Device** drop-down list.

### Register Grids

The **Thresholds, Voltage Measurement, AIN/DIAG/FMEA, Alert/Status, Enables, Configuration,** and **Broadcast/Version/Freq** tabs all include grids that display the contents of the selected device registers. These tabs are all updated to contain n number of rows, where n equals the total number of detected devices.

For a two-device ladder with a start address of 0x01, the grids on each tab are configured with two rows, as shown in Figure 2. The number of columns in each grid is set by the number of registers associated with that grid. In addition, each row has an associated device number button that, when pressed, sets that device as the active device, updating the **Active Device** drop-down list.

**Table 6. ADDRESS Register**

Bit 15	Bit 14	Bit 13	Bit 12	Bit 11	Bit 10	Bit 9	Bit 8
0	0	0	LA4	LA3	LA2	LA1	LA0
Bit 7	Bit 6	Bit 5	Bit 4	Bit 3	Bit 2	Bit 1	Bit 0
1	0	A0	A1	A2	A3	A4	0

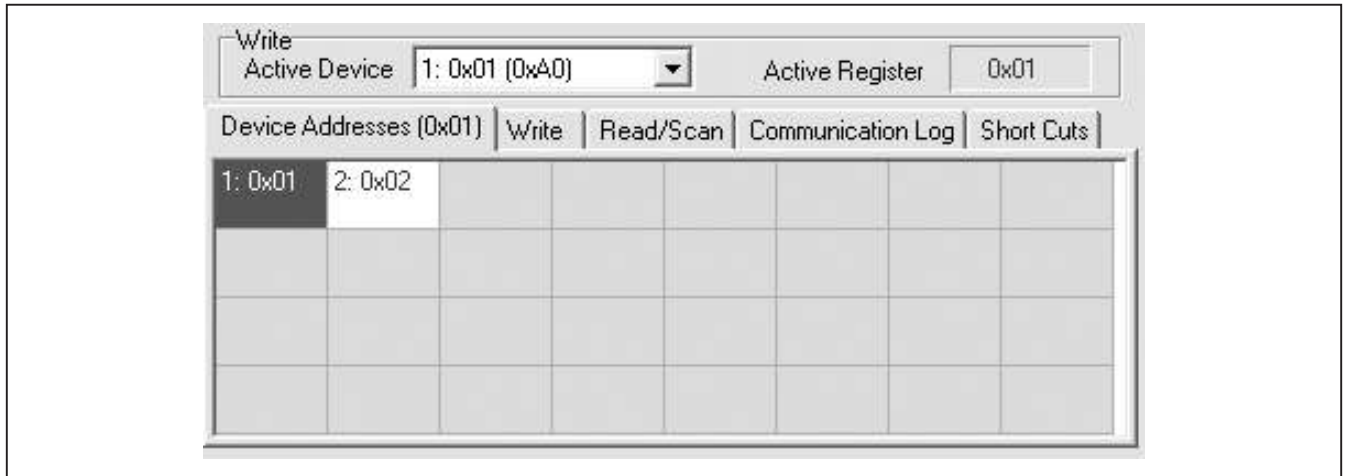

Figure 1. MAX11068 EV Kit Software (Device Address Grid)

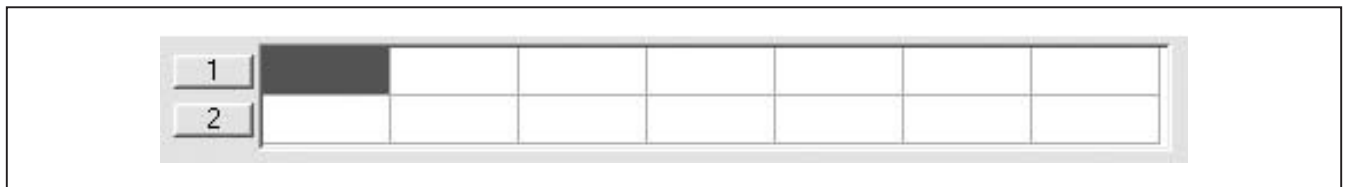

Figure 2. MAX11068 EV Kit Software (Device Rows)



# MAX11068 Evaluation System

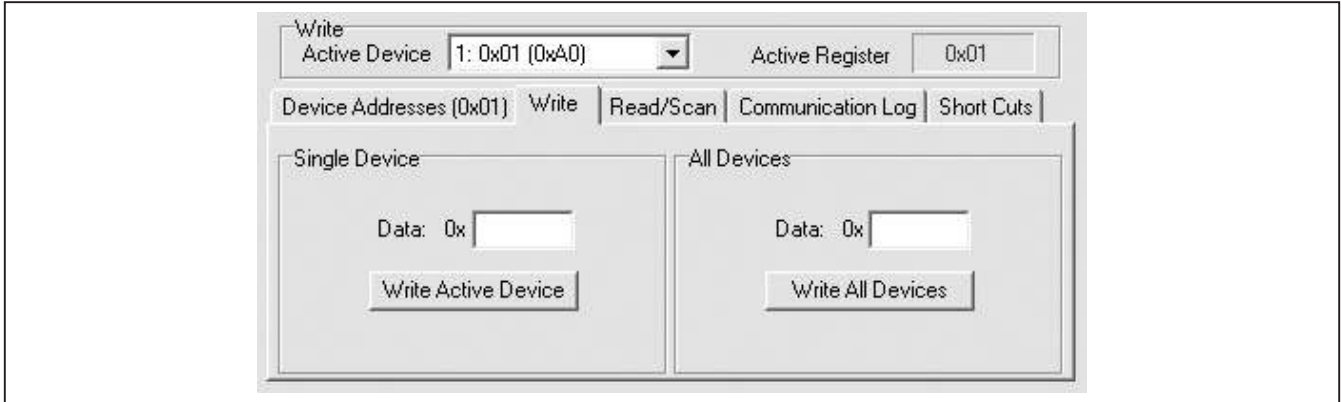

Figure 3. Write to Register Controls

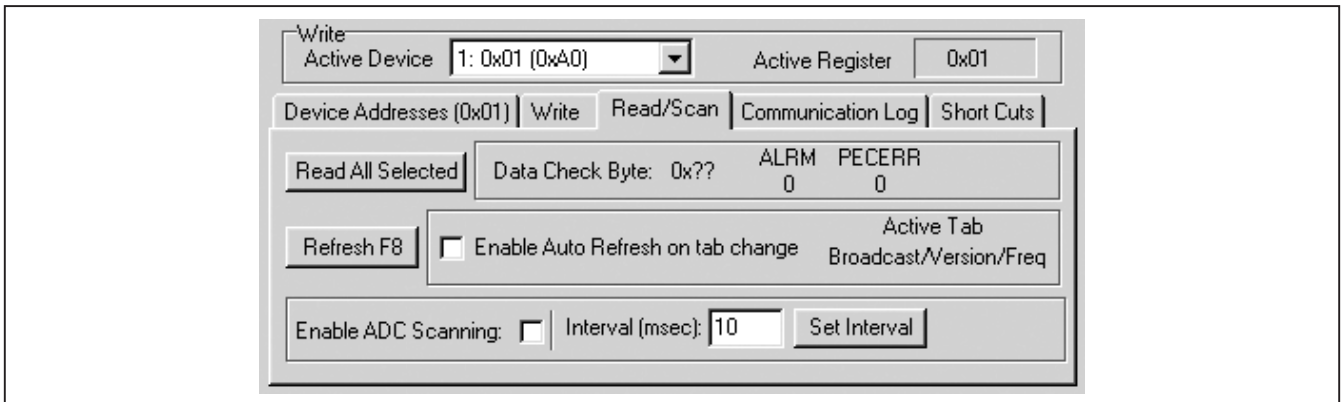

Figure 4. Read/Scan Tab Snapshot

## Write Registers

A specific device in the SMBus ladder can be written to by using the **Write** tab, **Active Register** group box, and **Active Device** drop-down list. To perform a write to a specific register of a single device:

- 1) Select the device to be written to from the **Active Device** drop-down list or from the grid on the **Device Addresses (0x01)** tab.
- 2) Select the register to be written to from the **Active Register** group box. The **Active Register** label also reflects the selected register.
- 3) Enter the hex value (####) into the **Data: 0x** edit box in the **Single Device** group box (Figure 3).
- 4) Press the **Write Active Device** button.

The **Write** tab can also be used to write an entered value into the active register of all the devices in the SMBus ladder. To perform a write to a specific register of all devices:

- 1) Select the register to be written to from the **Active Register** group box.
- 2) Enter the hex value (####) into the **Data: 0x** edit box in the **All Devices** group box.
- 3) Press the **Write All Devices** button.

## Read Registers

When performing a read operation, all the devices in the SMBus ladder are accessed. The read operation does not allow only one device to be read. The register checkboxes located on each register tab can be selected to enable a read of the associated register. In addition, each group of register checkboxes has an associated **ALL** checkbox that, when checked/unchecked, selects/deselects all the register checkboxes on that tab. The select all and deselect all operations can also be executed by selecting the **Actions | Active Tab | Select All Ctrl+A** or **Actions | Active Tab | Select None Ctrl+N** menu item. The read operations are performed using the controls on the **Read/Scan** tab or the keyboard short-

# MAX11068 Evaluation System

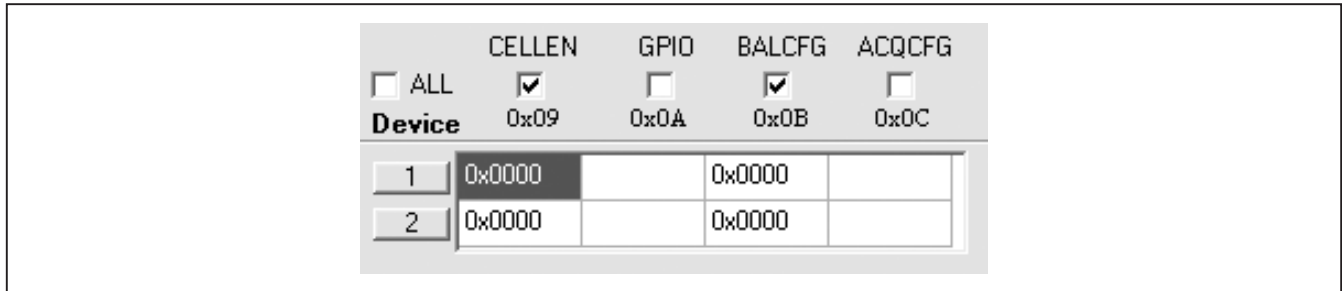

Figure 5. Configuration Grid after Executing "Read All Selected"

Table 7. Read Controls

CONTROL NAME	CONTROL TYPE	FUNCTION
<b>Read All Selected</b> Actions   Read All Selected F7	Button, Menu item	Reads all the selected registers. A register is selected by checking its associated register checkbox.
<b>Data Check Byte</b>	Label	Displays the contents of the data check byte as a hex value
<b>ALRM, PECERR</b>	Labels	Displays the status of the ALRM and PECERR bits of the data check byte
<b>Actions   Read All Registers</b>	Menu item	Read all registers of all devices in the SMBus ladder, regardless of the state of the register checkboxes
<b>Refresh F8</b> Actions   Refresh F8	Button, Menu item	Performs a read of all selected registers on the active/visible register tab
<b>Active Tab</b>	Label	Displays the name of the active/visible register tab
<b>Auto Refresh (tab change)</b>	Checkbox	When checked, the register tab is automatically refreshed when becoming active/visible.
<b>Enable ADC Scanning</b>	Checkbox	When checked, a scan of the ADC is initiated (STROBE bit set to 1) every x milliseconds, where x is set by the <b>Interval</b> controls below.*
<b>Interval (msec)</b>	Edit box	Used to enter the time interval between ADC scans
<b>Set Interval</b>	Button	Sets the time interval shown in the <b>Interval (msec)</b> edit box

\*See the ADC Scan section.

cuts listed under the **Actions** menu. At the completion of a read operation, the grid on the active register tab displays the data of the selected registers. Figure 4 is a snapshot of the **Read/Scan** tab and Figure 5 shows the result of a "Read All Selected" of the **Configuration** tab. Table 7 lists the available read controls and their function.

### Register Tabs

The 40 device registers are organized onto seven tab sheets: **Thresholds**, **Voltage Measurements**, **AIN1/AIN2/DIAG**, **Alter/Status**, **Enables**, **Configuration**, and **Broadcast/Version/Freq**. Each tab provides write access to each device in the SMBus ladder, as well as a grid that displays the contents of the devices' registers. The display grids are updated by performing read operations through the **Read/Scan** tab. See the *Read*

*Registers* section for more details. The write operations are performed using the **Write** tab or the individual write buttons located on each register tab.

### Thresholds Tab

The Thresholds tab (Figure 6) is used to configure the seven threshold registers. The data for the threshold registers are entered and displayed on the GUI as either a voltage or hex value. The threshold registers and their associated GUI controls are listed in Table 8.

The register buttons under the **Write to Active Device** label are used to write the entered data to the active device. The active device is selected from the **Device Addresses (0x01)** tab, or through the **Active Device** drop-down list. The **Write All** buttons under the **Write to ALL Devices** label are used to write the entered data to all devices in the SMBus ladder.

# MAX11068 Evaluation System

Evaluates: MAX11068

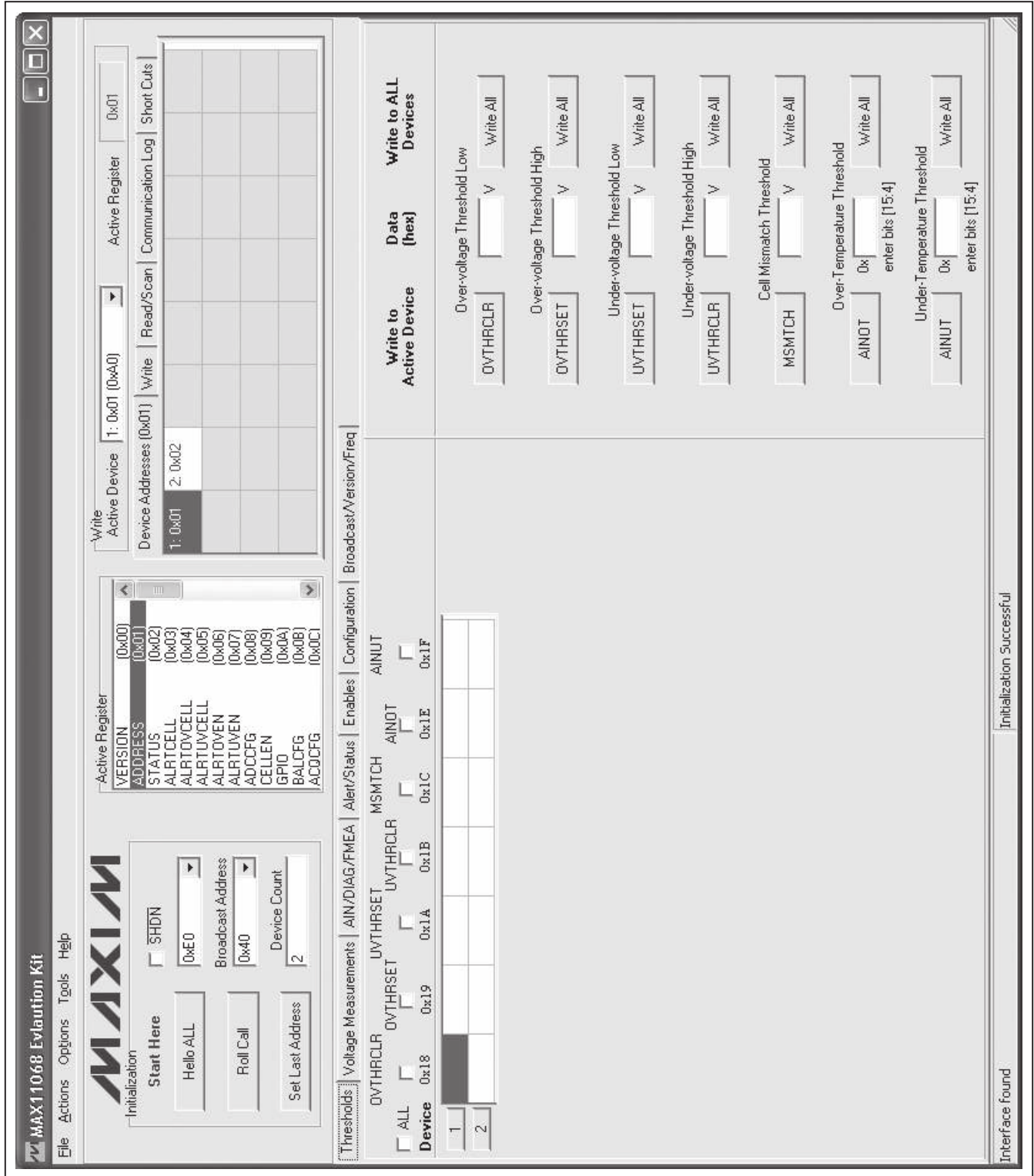

Figure 6. MAX11068 Evaluation Kit Software (Thresholds Tab)

# MAX11068 Evaluation System

**Table 8. Threshold Registers**

THRESHOLD REGISTER (ADDRESS)	GUI CONTROL	DISPLAY/DATA INPUT FORMAT
Overvoltage Clear (0x18)	OVTHRCLR	Voltage*
Overvoltage Set (0x19)	OVTHRSET	Voltage*
Undervoltage Set (0x1A)	UVTHRSET	Voltage*
Undervoltage Clear (0x1B)	UVTHRCLR	Voltage*
Cell Mismatch (0x1C)	MSMTCH	Voltage*
Auxiliary Analog Input Overtemperature (0x1E)	AINOT	Hex
Auxiliary Analog Input Undertemperature (0x1F)	AINUT	Hex

\*The maximum voltage setting is 5.0000V.

**Table 9. AIN1 and AIN2 Controls**

AIN_ GUI CONTROL	CONTROL TYPE	DESCRIPTION
<b>Conversion Value</b>	Label	Displays the 12-bit AIN_ conversion value
<b>Under Temperature Enable (COLDEN)</b>	Checkbox	Configures the COLDEN bit to enable/disable the ALRTHOT alarm*
<b>Over Temperature Enable (HOTEN)</b>	Checkbox	Configures the HOTEN bit to enable/disable the ALRTTCOLD alarm*
<b>Update Active Device</b>	Button	Configures the COLDEN and HOTEN bits of the active device
<b>Update All Devices</b>	Button	Configures the COLDEN and HOTEN bits of all devices

\*These bits work in parallel with the ALRMUTEN and ALRMOTEN registers.

For all the threshold registers, the data (D[11:0]) is contained in the upper 12 bits of the 16-bit register. When entering data into the **Under-Temperature Threshold** (AINUT) and **Over-Temperature Threshold** (AINOT) edit boxes, enter only the hex value of the upper 12 bits. The lower nibble of all threshold registers are ignored during a write and are read back as zeros.

### Voltage Measurements Tab

The **Voltage Measurements** tab (Figure 7) displays the results for the ADC conversions on cells 1–12, as well as the results for TOTAL, MAXCELL, and MINCELL. The register contents are displayed in the grid as voltages. The checkboxes at the top of the tab and their associated **Configure Cells (F9)** button are used to enable a cell for measurement. These checkboxes have the same function as the **CELL\_EN** checkboxes on the **Configuration** tab. See the *ADC Scan* section for details on setting up and initiating an ADC scan.

### AIN1/DIAG/FMEA Tab

The auxiliary analog inputs (AIN1 and AIN2), diagnostic (DIAG), and failure mode effects analysis (FMEA) registers are accessed from this tab (Figure 8). The tab is divided into four group boxes: **AIN1**, **AIN2**, **DIAG**, and **Failure Mode Effects Analysis (FMEA)**. The **DIAG** group box displays the 12-bit result of the self-diagnostic measurement and the **FMEA** group box displays the FMEA alerts and provides access to their associated mask bits. The **AIN\_** group boxes provide the controls listed in Table 9.

The AIN1, AIN2, and DIAG conversions must first be enabled before a valid conversion value can be read from the AIN or DIAG registers. A scan of the AIN\_ channel is enabled by selecting the **AIN\_EN** checkbox located on the **Enables** tab (Figure 10). A self-diagnostics conversion is enabled by selecting the **DIAGEN** checkbox located on the **Enables** tab. See the *Enables Tab* and *ADC Scan* sections.

# MAX11068 Evaluation System

Evaluates: MAX11068

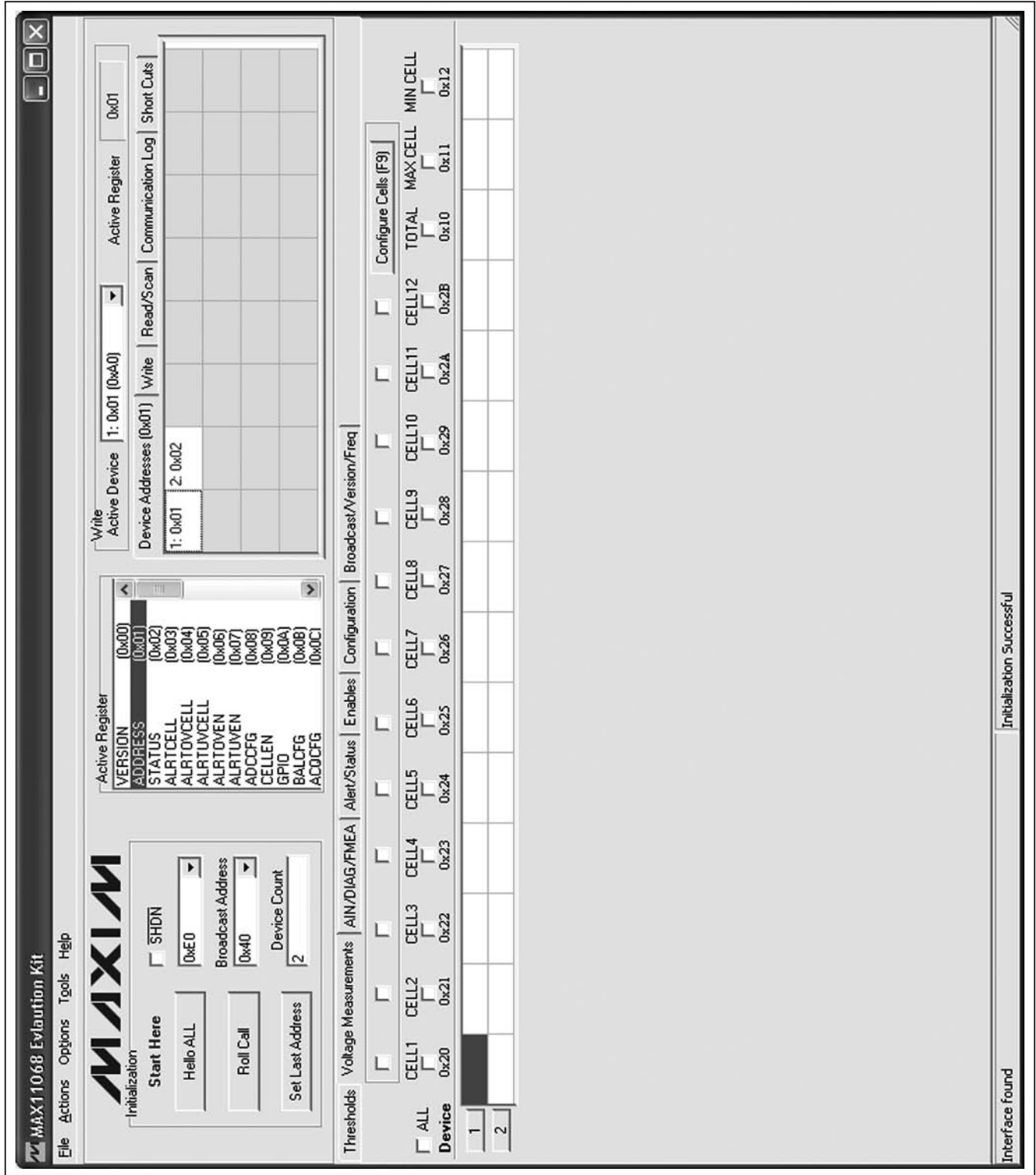

Figure 7. MAX11068 Evaluation Kit Software (Voltage Measurements Tab)

# MAX11068 Evaluation System

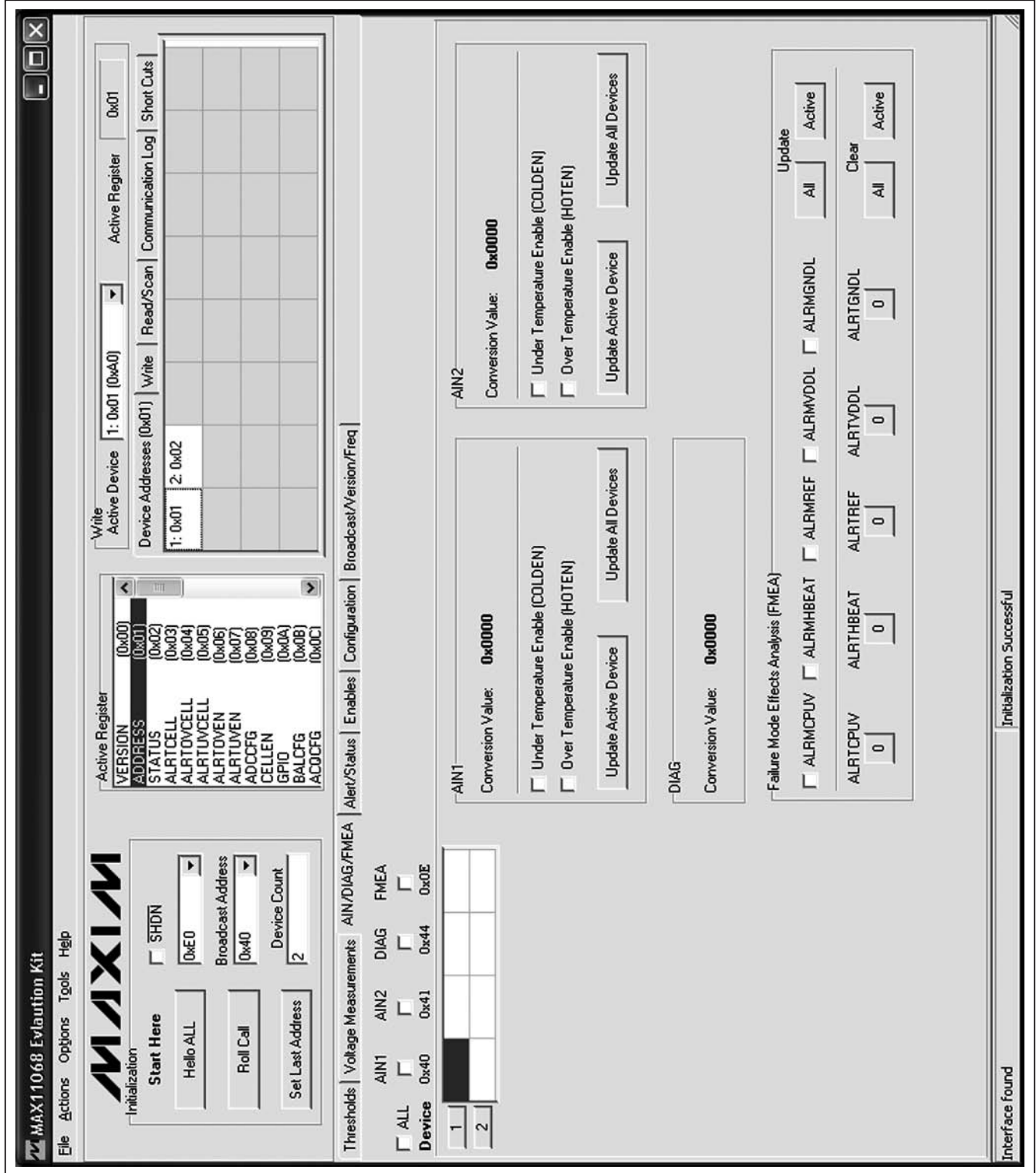

Figure 8. MAX11068 Evaluation Kit Software (AIN/DIAG/FMEA Tab)



# MAX11068 Evaluation System

## Alert/Status Tab

All device alerts are monitored from the **Alert/Status** tab (Figure 9). The right side of the tab is divided into two group boxes: **Status Flags (STATUS)** and **Alert Status (ALRTCELL, ALRTOVCELL, ALRTUVCELL)**. The **Status Flags (STATUS)** group box displays the alerts from the STATUS (0x02) register. The **Alert Status (ALRTCELL, ALRTOVCELL, ALRTUVCELL)** group box displays the alerts from the ALRTCELL (0x03), ALRTOV (0x04), and ALRTUV (0x05) registers. Refer to the *Auxiliary Analog Inputs and External Thermistor Supply Pin* and *Self-Diagnostics* sections in the MAX1068 IC data sheet for additional information.

Each group box contains buttons that are associated with that register's alert bits. When performing a read of these alert registers, the state of each alert bit is displayed on the buttons' faces. To clear an alert, a zero must be written to the bit position assigned to that specific alert. An alert is cleared by:

- 1) Selecting the alerts to be cleared:
  - Press the button displaying the alert. The button's label changes from 1 to 0.
- 2) Writing to the alert register(s):
  - Press the **Clear Active Device** button to clear the selected alerts of the active device (see the **Active Device** drop-down list), or
  - Press the **Clear All Devices** button to clear the selected alerts of all devices in the chain.

The alerts can be disabled by setting their associated alarm enable bit(s) to 0. The alarm enable bits for the status alerts are located in the ADCCFG (0x08) register. In addition, the AIN1 and AIN2 registers each contain 2 bits (HOTEN and COLDEN) that provide secondary enabling/disabling of the overtemperature and undertemperature alerts (ALRTTHOT and ALRTTCOLD).

The alarm enable bits for the ALRTOV and ALRTUV alerts are located in the OVALRTEN (0x06) and UVALRTEN (0x07) registers, respectively. The ALRTCELL alerts result from an ALRTOV or ALRTUV alert. Thus, to disable an ALRTCELL alert, both the ALRTOV and ALRTUV alerts for that cell must be disabled (i.e., to disable cell 12's alert (AL12), the OV12 and UV12 enable bits must be set to 0).

## Enables Tab

The MAX11068 alert and alarm functions are enabled/disabled by checking/unchecking the **Enables** tab (Figure 10) checkboxes and then pressing either the **Configure Active Device** or the **Configure All Devices** button. When enabled, the overvoltage and undervolt-

age alerts can be monitored and cleared using the buttons on the **Alert/Status** tab. See the *Alert/Status Tab* section. The overvoltage and undervoltage alert enable bits are contained in their register's lower 12 bits (`_VALRTEN[11:0]`).

The **General Configuration (ADCCFG)** group box provides **ALRM\_** checkboxes to enable/disable additional MAX11068 alert functions. These alerts are monitored and cleared using the buttons on the **Alert/Status** tab. The ADCCFG register is also used to enable self-diagnostic measurements (DIAGEN), enable conversions on the AUXIN1 and AUXIN2 inputs (AIN1EN and AIN2EN), and initiate an ADC scan. See the *ADC Scan* section for further scan details and refer to Table 13 in the IC data sheet for ADCCFG bit descriptions.

## Configuration Tab

The **Configuration** tab (Figure 11) is divided into four group boxes: **General Purpose I/O (GPIO)**, **Cell Balancing (BALCFG)**, **ADC acquisition time (ACQCFG)**, and **ADC Scan (CELLEN) – Global Setting**. Table 10 lists the configuration controls and their functions.

## Broadcast/Version/Freq Tab

This register tab (Figure 12) is used to change the broadcast address, read back each device's version number, and configure the I<sup>2</sup>C clock frequency. The broadcast address and version number are contained in the MAX11068 device registers, whereas the clock frequency is an interface configuration associated with the MINIQUSB command module.

**Broadcast Address:** The broadcast address is used by the host controller to communicate with all the devices in the SMBus ladder. This address is used by the host when executing roll call, write all, and read all commands. The broadcast address is contained in the lower 8 bits ([7:0]) of the 16-bit BROADCAST ADDRESS register and can be set in the 0x00 (0000 0000) through 0x7E (0111 1110) range. The **Broadcast Address** combo box provides a list of selectable addresses and allows a valid address to be entered into the edit box.

**Model and Version Number:** The lower nibble of the Version register (VER[3:0]) contains the IC's version number. The upper 12 bits (VER[15:4]) contain the MAX11068 model number, which is set to 0x068 (0000 0110 1000). The Version register is a read-only register.

**I<sup>2</sup>C Clock Frequency:** The I<sup>2</sup>C clock frequency is configured using the controls in the **I<sup>2</sup>C Clock Frequency** group box. The **Multiplier** and **Exponent** drop-down lists show the current or desired clock frequency.

# MAX11068 Evaluation System

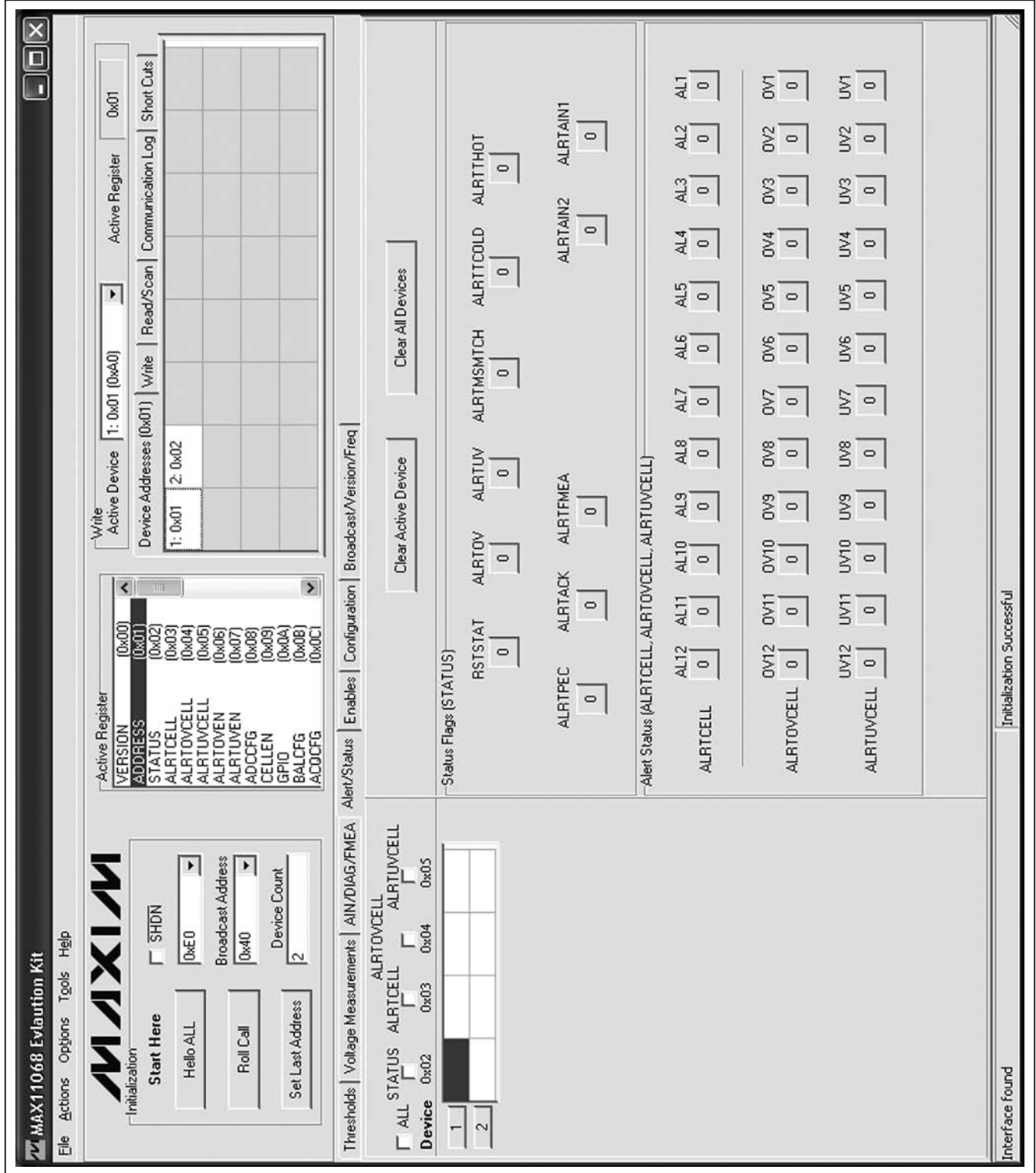

Figure 9. MAX11068 Evaluation Kit Software (Alert/Status Tab)

# MAX11068 Evaluation System

Evaluates: MAX11068

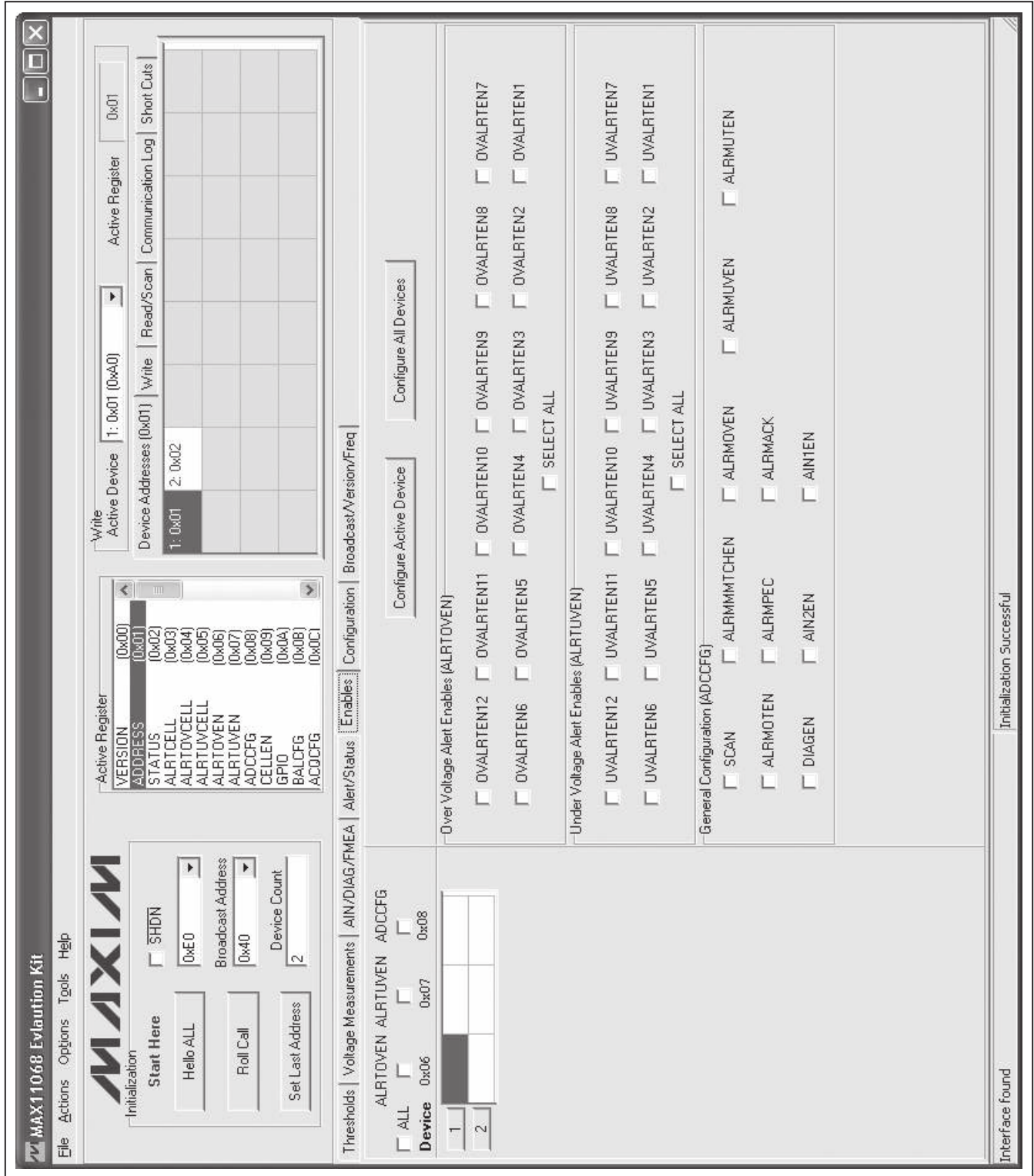

Figure 10. MAX11068 Evaluation Kit Software (Enables Tab)

# MAX11068 Evaluation System

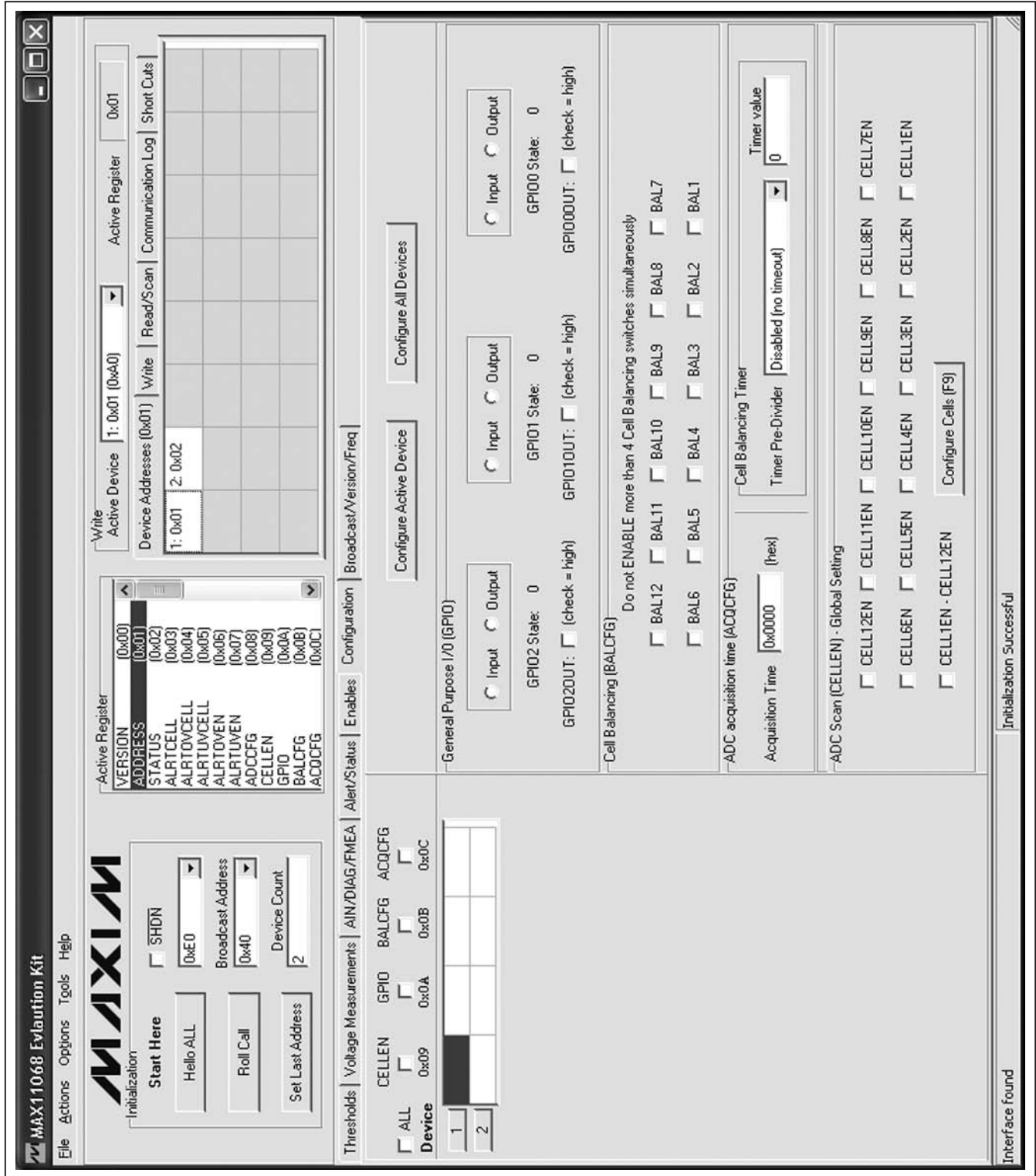

Figure 11. MAX11068 Evaluation Kit Software (Configuration Tab)



# MAX11068 Evaluation System

Evaluates: MAX11068

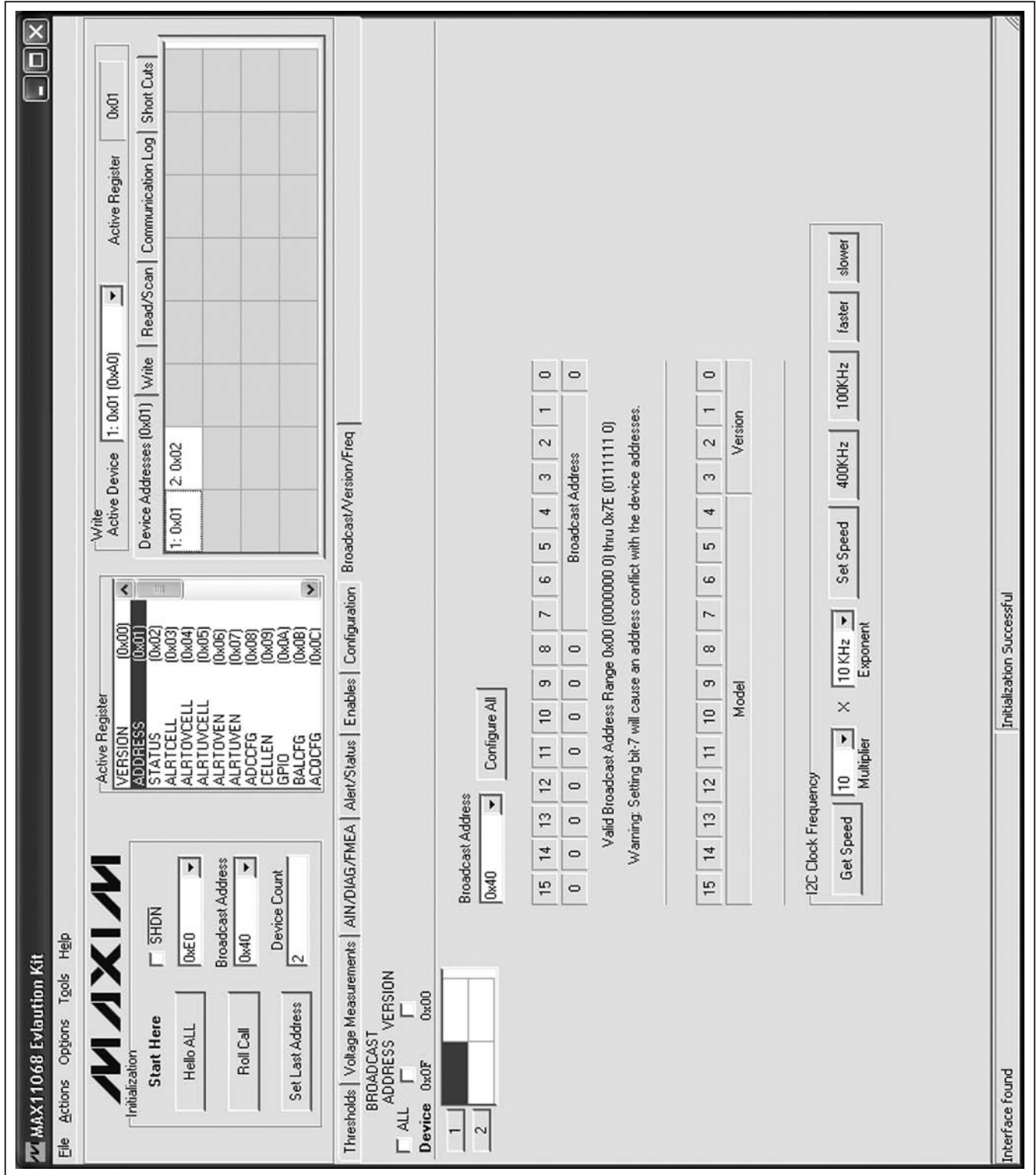

Figure 12. MAX11068 Evaluation Kit Software (Broadcast/Version/Freq Tab)

# MAX11068 Evaluation System

**Table 10. Configuration Controls**

CONTROL	CONTROL TYPE	FUNCTION
<b>General Purpose I/O (GPIO)</b>		
<b>Input</b>	Radio button	Configures the GPIO pin as an input
<b>Output</b>	Radio button	Configures the GPIO pin as an output
<b>GPIO_State</b>	Label	Displays the current state of the GPIO pin
<b>GPIO_OUT</b>	Checkbox	Control the GPIO pin when configured as an output
<b>Cell Balancing (BALCFG)</b>		
<b>BAL_</b>	Checkbox	Select which cell-balancing switches to enable/disable*
<b>ADC acquisition time (ACQCFG)</b>		
<b>Acquisition Time</b>	Edit box	6-bit acquisition time for AUXIN1/AUXIN2
<b>ADC Scan (CELLEN) - Global Setting</b>		
<b>CELL_EN</b>	Checkbox	Select which cell to enable for measurement
<b>CELL1EN - CELL12EN</b>	Checkbox	Selects all cells for measurement
<b>Configure Cells (F9)</b>	Button	Writes the <b>CELL_EN</b> checkbox settings to CELLEN register
<b>Configure Active Device**</b>	Button	Writes the configuration settings to the device listed in the <b>Active Device</b> drop-down list
<b>Configure All Devices**</b>	Button	Writes the configuration settings to all devices in the SMBus ladder

\*Do not enable more than four cell-balancing switches at a time.

\*\*Includes write to CELLCFG register.

**Table 11. Broadcast Address Byte**

Bit 7*	Bit 6	Bit 5	Bit 4	Bit 3	Bit 2	Bit 1	Bit 0
0	B6	B5	B4	B3	B2	B1	0

\*Setting bit 7 to 1 causes address conflicts with the device addresses.

**Table 12. Version Register**

Bit 15	Bit 14	Bit 13	Bit 12	Bit 11	Bit 10	Bit 9	Bit 8	Bit 7	Bit 6	Bit 5	Bit 4	Bit 3	Bit 2	Bit 1	Bit 0
0	0	0	0	0	1	1	0	1	0	0	0	VER[3:0]			

**Table 13. Read Controls**

CONTROL NAME	CONTROL TYPE	FUNCTION
<b>Get Speed</b>	Button	Determines the current bus speed setting and displays it in the two drop-down lists
<b>Multiplier</b>	Drop-down list	Selectable speed multiplier
<b>Exponent</b>	Drop-down list	Selectable speed exponent
<b>Set Speed</b>	Button	Sets clock frequency = (multiplier x exponent)
<b>400kHz</b>	Button	Sets the bus speed to 400kHz
<b>100kHz</b>	Button	Sets the bus speed to 100kHz
<b>faster</b>	Button	Increases the bus speed to the next faster setting
<b>slower</b>	Button	Decreases the bus speed to the next lowest setting



# MAX11068 Evaluation System

## ADC Scan

An ADC scan measures all enabled cell inputs, all enabled auxiliary inputs, and the self-diagnostics channel (if enabled). The conversion begins once the STROBE bit in the ADCCFG register is set. The following procedure outlines the steps to set up and initiate single or continuous ADC scanning.

### Set Up:

- 1) Enable the cells to measure:
  - Check the **CELL\_EN** checkboxes on the **Configuration** tab in the **ADC Scan (CELLEN) – Global Setting** group box.
  - Press the **Configure Cells (F9)** button.
- Note:** The cell channels can also be enabled with the checkboxes on the **Voltage Measurements** tab.
- 2) Select the cell registers to read:
  - Check the **CELL\_** checkboxes on the **Voltage Measurements** tab.
- 3) Enable the self-diagnostics and auxiliary inputs to measure:
  - Check the **DIAGEN**, **AIN2EN**, and **AIN1EN** checkboxes on the **Enables** tab in the **General Configuration (ADCCFG)** group box.
  - Press the **Configure Active Device** or the **Configure All Devices** button.
- 4) Select the self-diagnostics and auxiliary input registers for reading:
  - Check the **AIN1**, **AIN2**, and **DIAG** checkboxes on the **AIN1/DIAG/FMEA** tab.

### Initiate a Single ADC Scan:

- 1) Check the **SCAN** checkbox on the **Enables** tab, then press the **Configure All Devices** button, or
- 2) Select the **Voltage Measurements** tab and press F8 (Refresh) or F7 (Read All Selected) to read the selected cell registers.

**Note:** The STROBE bit is automatically set before a read is done on the **Voltage Measurements** tab.

### Initiate Continuous ADC Scanning:

- 1) Select the **Read/Scan** tab.
- 2) Enter the time delay between ADC scans into the **Interval (msec)** edit box.
- 3) Check the **Enable ADC scanning** checkbox.

**Note:** To save the data during a continuous ADC scan, perform the steps from the *Log Scanned Data* section in place of these steps.

## Log Scanned Data

The EV kit software allows the data, measured during continuous ADC scanning, to be saved to file. This feature is available by selecting the **File | Log Scan Data** menu item and should be set up before scanning is started. The steps below explain how to set up data logging:

- 1) Perform steps 1–4 in the *ADC Scan* section.
- 2) Select the **File | Log Scan Data** menu item or press CTRL+L. The following window appears:

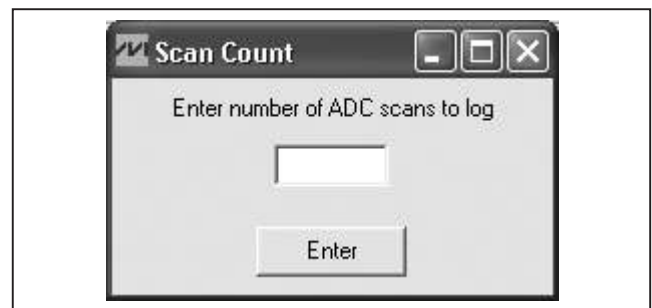

- 3) Enter the number (n) of ADC scans to record, and then press **Enter**.
- 4) Select the **Read/Scan** tab.
- 5) Enter the time delay between ADC scans into the **Interval (msec)** edit box.
- 6) Check the **Enable ADC scanning** checkbox. A red **Logging Data** label appears, notifying that data is being recorded.
- 7) Once n number of scans have been completed, the **Log Complete** window appears. Press **OK**.



- 8) A **Log Data** dialog box appears. The default file name is 11068all and the default file type is .xls (Excel spreadsheet). If a different name or file type is preferred, enter it into the **File name** edit field. Press **Save**.

At the completion of this process, data logging is disabled, but the continuous ADC scanning continues until the **Enable ADC Scanning** checkbox is unchecked. The file generated by the software logs the measured data of the enabled channels for all the devices in the SMBus ladder.

# MAX11068 Evaluation System

A	B	C	D	E	F	G	H	I	J	K	L	M	N	O	P	Q	R	S
1	Thu Dec 18 15:27:28 2008																	
2																		
3	MAX11068 Evaluation Kit - ADC DATA [2 Device(s)]																	
4																		
5																		
6	CELL1	CELL2	CELL3	CELL4	CELL5	CELL	CELL7	CELL8	CELL9	CELL10	CELL11	CELL12	TOTAL	MAX	MIN	AIN0	AIN1	DIAG
7	0x20	0x21	0x22	0x23	0x24	0x25	0x26	0x27	0x28	0x29	0x2A	0x2B	0x10	0x11	0x12	0x40	0x41	0x44
8	Device																	
9	1	3.8877	3.8962	3.8962	3.895	3.8974	3.8974	3.8987	3.8987	3.8999	3.9011	3.9035	46.7692	3.9035	(12)	3.8877	(1)	
10	2	3.8913	3.8999	3.8962	3.8974	3.8974	3.8987	3.8974	3.9011	3.9011	3.9011	3.9035	46.7827	3.9035	(12)	3.8913	(1)	
11	1	3.8889	3.895	3.8962	3.8974	3.8974	3.8974	3.8974	3.8987	3.9011	3.9011	3.9035	46.7705	3.9035	(12)	3.8889	(1)	
12	2	3.8913	3.8967	3.8974	3.895	3.8962	3.8974	3.8962	3.9011	3.9023	3.9023	3.9023	46.7766	3.9023	(12)	3.8913	(1)	
13	1	3.8901	3.895	3.8962	3.8974	3.8974	3.8974	3.8987	3.9011	3.8999	3.9011	3.9035	46.7729	3.9035	(12)	3.8901	(1)	
14	2	3.8913	3.8967	3.8974	3.8962	3.8967	3.8974	3.8987	3.9011	3.9011	3.9011	3.9035	46.7839	3.9035	(12)	3.8913	(1)	
15	1	3.8901	3.895	3.8962	3.8962	3.8962	3.8974	3.8974	3.8987	3.8999	3.9011	3.9035	46.768	3.9035	(12)	3.8901	(1)	
16	2	3.8913	3.8967	3.8967	3.8974	3.8967	3.8987	3.8962	3.9011	3.9023	3.9011	3.9048	46.7875	3.9048	(12)	3.8913	(1)	
17	1	3.8901	3.8938	3.8962	3.8962	3.8974	3.8962	3.8987	3.9011	3.8987	3.9023	3.9035	46.7705	3.9035	(12)	3.8901	(1)	
18	2	3.8901	3.8967	3.8974	3.8962	3.8974	3.8987	3.8974	3.8999	3.9011	3.9011	3.9035	46.779	3.9035	(12)	3.8901	(1)	
19	1	3.8889	3.895	3.8974	3.8962	3.8962	3.8974	3.8962	3.8999	3.8987	3.9011	3.9023	46.7656	3.9023	(12)	3.8889	(1)	
20	2	3.8913	3.8999	3.8967	3.8962	3.8974	3.8987	3.8974	3.8962	3.9011	3.9011	3.9023	46.7814	3.9023	(12)	3.8913	(1)	
21	1	3.8889	3.895	3.8962	3.8962	3.8974	3.8974	3.8987	3.8999	3.8999	3.8999	3.9023	46.768	3.9023	(12)	3.8889	(1)	
22	2	3.8926	3.8967	3.8974	3.8962	3.8974	3.8987	3.8974	3.8999	3.9023	3.8999	3.9023	46.7802	3.9023	(12)	3.8926	(1)	
23	1	3.8889	3.8938	3.8974	3.8962	3.8974	3.8987	3.8974	3.8999	3.8999	3.9011	3.9023	46.7692	3.9023	(12)	3.8889	(1)	
24	2	3.8913	3.8999	3.8974	3.895	3.8974	3.8962	3.8974	3.9011	3.9011	3.9035	3.9035	46.7827	3.9035	(12)	3.8913	(1)	
25	1	3.8877	3.895	3.8962	3.8962	3.8974	3.8962	3.8987	3.9011	3.8999	3.8999	3.9035	46.7692	3.9035	(12)	3.8877	(1)	
26	2	3.8901	3.8967	3.8962	3.8962	3.8974	3.8987	3.8974	3.9011	3.8999	3.9023	3.9035	46.779	3.9035	(12)	3.8901	(1)	
27	1	3.8889	3.8938	3.8962	3.8962	3.895	3.8962	3.8987	3.8987	3.8999	3.9011	3.9023	46.7656	3.9023	(12)	3.8889	(1)	
28	2	3.8913	3.8967	3.8974	3.8962	3.8987	3.8987	3.8974	3.9011	3.9023	3.9023	3.9023	46.7851	3.9023	(12)	3.8913	(1)	
29																		
30																		

Figure 13. File Generated by a 10-Measurement ADC Scan

# MAX11068 Evaluation System

Evaluates: MAX11068

## Save/Load Register Configuration

The software features a **Save Register Configuration** and **Load Register Configuration** function. This allows all current register configurations and GUI control settings to be saved and loaded at a later time. When saving, the software first performs a read of all the registers of each device in the SMBus ladder to obtain their current configurations. Once complete, a **Save All Data** dialog box appears asking for a file name and type (the default is 11068config.csv). When loading, a **Load Configuration** file window appears asking for a file to open (the default is 11068config.csv). The load function configures the GUI, writes the data from the file to the registers of all the devices in the SMBus ladder, and finishes by performing a read of all the selected device registers.

**Note:** Read-only data is not saved to the configuration file. Only configurable options are saved to the configuration file.

## PEC Byte

The EV kit software supports packet-error checking (PEC) by implementing a CRC-8 algorithm to maintain data integrity with the devices in the SMBus ladder. The software generates the PEC byte when executing the SETLASTADDRESS, WRITEALL, and WRITEDEVICE commands and verifies the PEC byte received from the devices after a READALL command. The software makes this algorithm available as a PEC calculator, which is found under the Tools menu. Figure 14 provides a snapshot of the PEC calculator.

## Detailed Description of Hardware

The MAX11068 evaluation kit (EV kit) is designed to allow for a thorough evaluation of the MAX11068 smart data-acquisition interface. The EV kit PCB is made up of two boards, each containing nearly identical MAX11068 circuits. The left side of the EV kit is referenced as side (A) and the right side is referenced as side (B). The two-boards-in-one design provides a simple demonstration

of the MAX11068's SMBus ladder capability. The additional dual-row headers (J1 and J102) provided on each board allow for a 31-device (max) SMBus ladder. Each side of the EV kit consists of several sections to facilitate the evaluation of the MAX11068 devices.

The MAX11068 device can be configured to operate with 2 to 12 battery cells. The cells can be directly connected to the EV kit, or can be routed through header P3. See the *Battery Cells* section. The EV kit also facilitates monitoring the alarm pins, utilizing the auxiliary pins, and accessing the general-purpose input/output (GPIO) pins.

The EV kit also includes two MAX11080 circuits that complement the MAX11068 devices, providing additional overvoltage and undervoltage monitoring. In addition, the MAX11080 devices are each capable of monitoring up to 12 battery cells and can also be daisy-chained with up to 31 devices.

The J3 connector, located on side (A) of the EV kit, is used to connect with Maxim's MINIQUSB command module, which provides I<sup>2</sup>C communication. When connected to the MINIQUSB command module, the EV kit can be evaluated with EV kit software. See the *Detailed Description of Software* section.

When evaluating the MAX11068 EV system, both the MAX11068 IC data sheet and this document should be referenced.

## Reference Designators and IC Pin Net Names

One EV kit includes two connected boards. This design demonstrates the cascading ability of the MAX11068 device. The left side of the EV kit is referenced as the (A) side and the right side of the EV kit is referenced as the (B) side. Both boards contain the same circuit design, with the exception of host interface headers (P2) located on the (A) side of the EV kit.

The two boards are mechanically connected at the center of the EV kit and are electrically connected with a

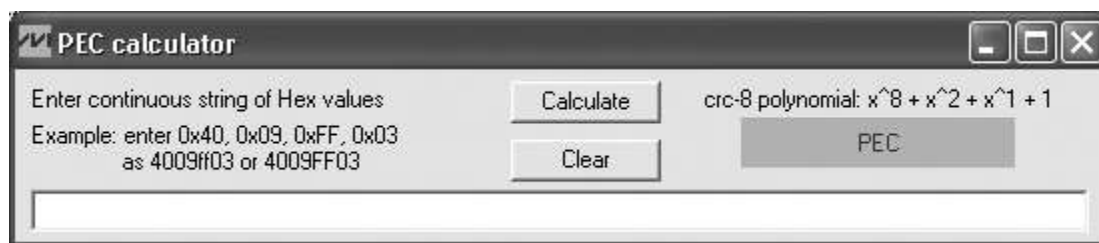

Figure 14. PEC Calculator

# MAX11068 Evaluation System

ribbon cable between headers J2 and J101. Each board can also be cascaded to another EV kit, allowing for up to 31 MAX11068 devices on a single SMBus ladder. Refer to the *I<sup>2</sup>C/SMBus Ladder Initialization Sequence* section in the MAX11068 IC data sheet.

To distinguish between the two separate (A) and (B) boards that make up the EV kit, the reference designators and IC pin net names used on the PCB and in the schematics follow the suffix scheme below:

The suffix represents either the (A) side of the EV kit or the (B) side of the EV kit. The boards are labeled in the upper-right corner with (A) or (B).

## Net Names:

- MAX11068 IC pin net names contain the IC pin name with an A or B suffix.
- MAX11080 IC pin net names contain the IC pin name with a CA or CB suffix.
- All other net names contain an A or \_A suffix if associated with the (A) side, and a B or \_B suffix if associated with the (B) side.

## Reference Designators:

- Board (A) has components numbered from 0 to 99.
- Board (B) has components numbered from 100 to 199.

**Example:** Component R1 on board (A) is the same circuit element as R101 on board (B).

## Device Startup

To start up the EV kit, apply at least 6V across the PACKA+ and PACKA- PCB pads and drive the SHDNINA net high by one of the methods that follow.

### Software SHDNINA Control:

- 1) Verify that a shunt is not installed on jumpers JU12, JU21, JU112, and JU121.
- 2) Install shunts on jumpers JU25, JU26, JU125, and JU126.
- 3) Using a USB cable, connect the MINIQUSB command module to a PC.
- 4) Connect the MINIQUSB command module to the EV kit's J3 header, using the MINIQUSB-XHV board.
- 5) Start the EV kit software.
- 6) Ensure that the **SHDN** checkbox on the MAX11068 software is not checked.

**Note:** The  $\overline{\text{SHDNINA}}$  net is pulled up to 3.3V by the MINIQUSB's K1 GPIO pin.

### Hardware SHDNINA Control:

- 1) Verify that shunts are not installed on jumpers JU25, JU26, JU125, and JU126.
- 2) Install shunts on jumpers JU12, JU21, JU112, and JU121.
- 3) Using a USB cable, connect the MINIQUSB command module to a PC.
- 4) Connect the MINIQUSB command module to the EV kit's J3 header, using the MINIQUSB-XHV board.

**Note:** The  $\overline{\text{SHDNINA}}$  net is pulled up to the MINIQUSB's 3.3V (VDD) supply.

Once  $\overline{\text{SHDNINA}}$  is pulled high, the MAX11068 VAA regulator is enabled and the device continues with the device power-up sequence. Refer to Figure 20 in the IC data sheet for further details. Once the power-up sequence is complete, the MAX11068 device is fully functional. If additional EV kit modules are connected to the SMBus ladder, their power-up sequence is initiated once the VDDU\_ signal of the lower module reaches regulation.

**Note:** This startup sequence assumes that side (A) is board 1 in the SMBus ladder, although the same startup sequence can be applied to an SMBus ladder that uses side (B) as board 1, where board 1 is the board connected to the MINIQUSB command module.

## Battery Cells

When evaluating the EV kit, the cell stack voltage is provided by cascading 2 to 12 battery cells between the C0\_A-to-C12\_A and C0\_B-to-C12\_B nodes, or by applying DC voltages between PACKA+ and PACKA- and between PACKB+ and PACKB-. The following sections explain how to configure the EV kit and connect the battery cells.

### Cell Configuration

A ribbon cable must be connected between headers J2 and J101 when evaluating the entire EV kit.

- 1) Configure switch SW1 and SW101 according to Table 14.
- 2) When using a DC power supply, the cascaded 2k $\Omega$  resistors provide divided-down voltages to the cell input pins. This, in effect, emulates the connection of 12 battery cells.
- 3) Configure jumpers JU2–JU11, and JU102–JU111 according to the number of battery cells (actual or emulated) that are connected to the system (see Table 15).

# MAX11068 Evaluation System

Evaluates: MAX11068

**Table 14. Switch SW1, SW101 Description**

SW1, SW101	CELL-STACK VOLTAGE	CONNECTION
All off*	2–12 battery cells	Cells cascaded between C0_A, C12_A and C0_B, C12_B nodes
All on	DC power supply to emulate battery	See step 10 in the <i>Quick Start, Procedure</i> section

\*Default position.

**Table 15. Jumpers JU2–JU11 and JU102–JU111 Description**

NO. OF CELLS	SHUNT POSITION									
	JU2, JU102	JU3, JU103	JU4, JU104	JU5, JU105	JU6, JU106	JU7, JU107	JU8, JU108	JU9, JU109	JU10, JU110	JU11, JU111
2	On	On	On	On	On	On	On	On	On	On
3	Off	On	On	On	On	On	On	On	On	On
4	Off	Off	On	On	On	On	On	On	On	On
5	Off	Off	Off	On	On	On	On	On	On	On
6	Off	Off	Off	Off	On	On	On	On	On	On
7	Off	Off	Off	Off	Off	On	On	On	On	On
8	Off	Off	Off	Off	Off	Off	On	On	On	On
9	Off	Off	Off	Off	Off	Off	Off	On	On	On
10	Off	Off	Off	Off	Off	Off	Off	Off	On	On
11	Off	Off	Off	Off	Off	Off	Off	Off	Off	On
12*	Off	Off	Off	Off	Off	Off	Off	Off	Off	Off

\*Default position.

**Table 16. 8-Cell Connection**

CELL	+ TERMINAL	- TERMINAL
1	C1_	C0_
2	C2_	C1_
3	C3_	C2_
4	C4_	C3_
5	C5_	C4_
6	C6_	C5_
7	C7_	C6_
8	C8_	C7_
—	C9_ shorted to C8_	
—	C10_ shorted to C9_	
—	C11_ shorted to C10_	
—	C12_ shorted to C11_	

**Table 17. Headers P3 and P103\* Cell Connections**

CELL	+ TERMINAL	- TERMINAL
1	P3-2	P3-4
2	P3-4	P3-6
3	P3-6	P3-8
4	P3-8	P3-10
5	P3-10	P3-12
6	P3-12	P3-14
7	P3-14	P3-16
8	P3-16	P3-18
9	P3-18	P3-20
10	P3-20	P3-22
11	P3-22	P3-24
12	P3-24	P3-26

\*P103 has same cell connections as P3.

# MAX11068 Evaluation System

## Cell Connections

When using actual or emulated battery cells, keep in mind the following cell-connection requirements (see Table 16 for an 8-cell example):

- A minimum of 2 cells must be connected to each MAX11068 device.
- A maximum of 12 cells can be connected to each MAX11068 device.
- The C0\_ to C1\_ cell inputs must always be populated with a battery cell.
- The remaining cells are populated between C1\_ and C2\_, C2\_ and C3\_, and so on, until all cells are connected.
- All unused cell inputs must be shorted together, using the appropriate JU2–JU11 or JU102–JU11 jumpers.

When using DC power supplies to emulate battery cells, set its output in the  $(n \times 0.5V)$  to  $(n \times 4.7V)$  range, where  $n$  is the number of cells being emulated by the DC power supply. Connect the power supplies between the PACK\_+ and PACK\_- PCB pads.

When using actual battery cells, connect them across the appropriate C#\_ PCB pads, or route them through the P3 and P103 shrouded headers. When connecting the cells through the P3 and P103 headers, use switches SW21, SW22, SW121, and SW122 to switch the battery cells in and out of the system (see Figures 16a–19).

## SMBus Ladder

The MAX11068 includes an I<sup>2</sup>C bus system that allows cascading of up to 31 MAX11068 devices. The EV kit facilitates device cascading by routing the I<sup>2</sup>C bus system to headers J1, J2, J101, and J102. These headers are used to cascade multiple EV kit boards together. As shipped, the EV kit comprises two boards, a simple SMBus ladder consisting of two MAX11068 devices. To achieve a 31-device SMBus ladder, 16 EV kits are needed, with only one of the boards on the 16th EV kit being used. See Figures 15a and 15b for illustrations of an EV kit SMBus ladder. See Tables 18–21 for J1, J2, J101, and J102 pinouts.

**Note:** A single EV kit can be broken into two boards. In doing so, an SMBus ladder can comprise only (A) boards, only (B) boards, or a combination of both (A) and (B) boards. When cascading EV kits, observe the following:

- Connect the host controller (e.g., MINIQUSB command module) to the J3 header of the lowest board (board 1).
- Ensure that the 3in ribbon cable is installed across headers J2 and J101, except in the case of the last EV kit on the SMBus ladder.
- Use the provided 6in ribbon cable to connect the lower EV kit's J102 header to the J1 header of the next EV kit.

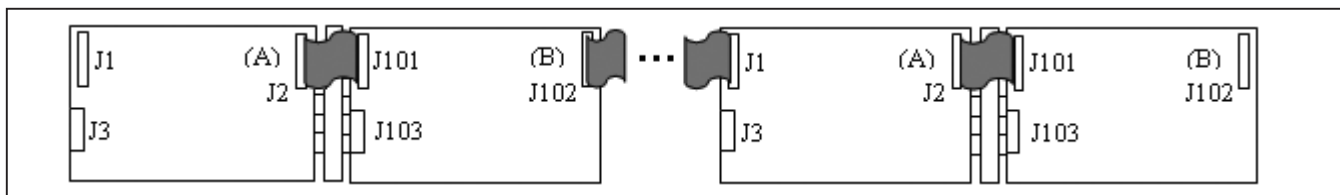

Figure 15a. MAX11068 EV Kit SMBus Ladder with Side (A) as Board 1

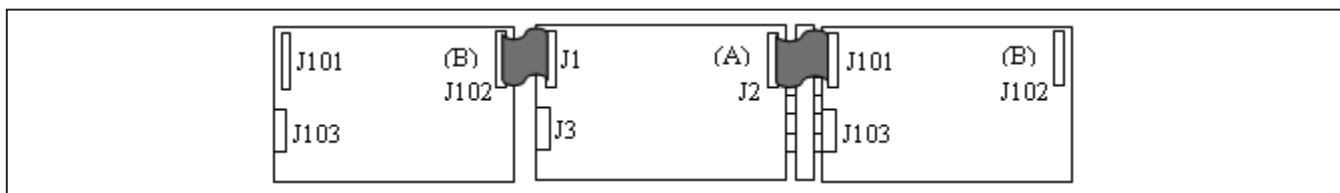

Figure 15b. MAX11068 EV Kit SMBus Ladder with Side (B) as Board 1



# MAX11068 Evaluation System

Tables 18–21 provide the complete pinouts for the inter-board connectors provided on the EV kit. The nets listed in the tables are not necessarily the same as the pins' actual net, as shown in the EV kit schematics. These nets are marked with an asterisk to signify that they are net associations of the header pin (see Figures 16a–19).

## Alarm Monitoring

The EV kit provides LED monitoring circuits for the alarm outputs of the MAX11068 and MAX11080 devices. The LED circuit is utilized by installing a shunt on the appropriate jumper (see Table 22). When the circuits are used, the LEDs provide visual indications of alert conditions. Refer to the *Alert and Alarm Status Functions* section in the MAX11068 IC data sheet for types of possible alerts and additional information.

**Table 18. Header J1**

PIN NO. (ODD)	NET	PIN NO. (EVEN)	NET
1	$\overline{\text{SHDNA}}^{**}$	2	GNDLA
3	SCLLA*	4	
5	SDALA*	6	
7	ALRMLA*	8	
9	C0_A	10	C0_A
11		12	
13	$\overline{\text{SHDNINCA}}^{**}$	14	AGNDCA
15	N.C.	16	
17	N.C.	18	
19	ALRMOUTCA*	20	

\*Net association.

\*\*Connected to both  $\overline{\text{SHDNINA}}$  and  $\overline{\text{SHDNINCA}}$ .

**Table 19. Header J2**

PIN NO. (ODD)	NET	PIN NO. (EVEN)	NET
1	CP+A*	2	GNDU1*
3	SCLU_A	4	
5	SDAU_A	6	
7	ALRMU_A	8	
9	C12_A	10	C12_A
11		12	
13	CP+CA*	14	GNDU2*
15	N.C.	16	
17	N.C.	18	
19	ALRMINC_A	20	

\*Net association.

**Note:** LED2 and LED102 on the EV kit can cause over-voltage level errors in the MAX11080 devices (U2 and U102). This is due to the current drawn by the LED. To avoid these errors, remove the shunts from jumpers JU24 and JU124 when performing a detailed evaluation of the MAX11080 devices.

## Auxiliary Inputs

The auxiliary inputs of the MAX1068 devices are routed to jumpers JU0, JU1, JU100, and JU101. This allows the auxiliary analog inputs to be used to measure external resistance temperature detector (RTD) components. A negative temperature coefficient (NTC) RTD can be configured with the AUXIN1 or AUXIN2 analog inputs to accurately monitor module or battery-cell temperature. When the auxiliary inputs are not used, a shunt can be installed on its associated jumper, providing a known pin state (AGNDA).

**Table 20. Header J101**

PIN NO. (ODD)	NET	PIN NO. (EVEN)	NET
1	$\overline{\text{SHDNINB}}^*$	2	GNDLB
3	SCLLB*	4	
5	SDALB*	6	
7	ALRMLB*	8	
9	C0_B	10	C0_B
11		12	
13	$\overline{\text{SHDNINCB}}^*$	14	AGNDCB
15	N.C.	16	
17	N.C.	18	
19	ALRMOUTCB*	20	

\*Net association.

**Table 21. Header J102**

PIN NO. (ODD)	NET	PIN NO. (EVEN)	NET
1	CP+B*	2	GNDU3*
3	SCLU_B	4	
5	SDAU_B	6	
7	ALRMU_B	8	
9	C12_B	10	C12_B
11		12	
13	CP+CB*	14	GNDU4*
15	N.C.	16	
17	N.C.	18	
19	ALRMINC_B	20	

\*Net association.

# MAX11068 Evaluation System

**Table 22. Alarm Jumpers**

ALARM OUTPUT (DEVICE)	JUMPER*	LED
ALRMLA (U1)	JU20	LED1
ALRMOUTCA (U2)	JU24	LED2
ALRMLB (U101)	JU120	LED101
ALRMOUTCB (U102)	JU124	LED102

\*To use the LED circuit, install a shunt on the jumper.

**Table 23. Auxiliary Jumpers**

AUXILIARY INPUT (DEVICE)	JUMPER*
AUXIN1A (U1)	JU0
AUXIN2A (U1)	JU1
AUXIN1B (U2)	JU100
AUXIN2B (U2)	JU101

\*To use the auxiliary input, remove the shunt from the jumper.

**Table 24. MAX11080 Overvoltage Threshold Configuration**

OVERVOLTAGE LEVEL (V)	SHUNT POSITION			
	JU16, JU116 (OVSEL3)	JU15, JU115 (OVSEL2)	JU14, JU114 (OVSEL1)	JU13, JU113 (OVSEL0)
3.3	2-3	2-3	2-3	2-3
3.4	2-3	2-3	2-3	1-2
3.5	2-3	2-3	1-2	2-3
3.6	2-3	2-3	1-2	1-2
3.7	2-3	1-2	2-3	2-3
3.8	2-3	1-2	2-3	1-2
3.9	2-3	1-2	1-2	2-3
4.0	2-3	1-2	1-2	1-2
4.1	1-2	2-3	2-3	2-3
4.2	1-2	2-3	2-3	1-2
4.3	1-2	2-3	1-2	2-3
4.4	1-2	2-3	1-2	1-2
4.5	1-2	1-2	2-3	2-3
4.6	1-2	1-2	2-3	1-2
4.7	1-2	1-2	1-2	2-3
4.8	1-2	1-2	1-2	1-2

## MAX11080 Battery-Pack Fault Monitor (U2, U102)

Included on the EV kit are two MAX11080 high-voltage battery-pack fault monitors. The MAX11080 devices complement the MAX11068 devices, providing redundant overvoltage- and undervoltage-fault detection. The overvoltage and undervoltage thresholds are configured by the jumpers on the OVSEL(3:0) and UVSEL(2:0) inputs of the MAX11080 devices. Jumpers JU13–JU19 are used to configure device U2 and jumpers JU113–JU119 are used to configure device U102 (see Tables 24 and 25).

In addition, when evaluating the MAX11080 devices, the TOPSELC\_ pin needs to be configured to indicate which

MAX11080 device is the top-most device in the ladder. This is set through jumper JU28 for device U2 and jumper JU128 for device U102 (see Table 26).

## I<sup>2</sup>C Interface

The EV kit interfaces with Maxim's MINIQUSB command module through header J3 or J103, depending on which side of the EV kit is used as board 1 in the SMBus ladder. The command module supports the I<sup>2</sup>C protocol, allowing for software control and monitoring of all cascaded MAX11068 devices. The lowest MAX11068 device of the SMBus ladder interfaces directly with the MINIQUSB command module (i.e., host controller).

# MAX11068 Evaluation System

**Table 25. Undervoltage Threshold Configuration**

UNDERVOLTAGE LEVEL (V)	SHUNT POSITION		
	JU17, JU117 (UVSEL2)	JU18, JU118 (UVSEL1)	JU19, JU119 (UVSEL0)
Disabled	2-3	2-3	2-3
1.6	2-3	2-3	1-2
1.8	2-3	1-2	2-3
2.0	2-3	1-2	1-2
2.2	1-2	2-3	2-3
2.4	1-2	2-3	1-2
2.6	1-2	1-2	2-3
2.8	1-2	1-2	1-2

**Table 26. TOPSECL\_ Jumpers (JU28, JU128)**

SHUNT POSITION	TOPSELC_ PIN	DESCRIPTION
1-2	Connected to VAAC_	Device is the top-most device in the device ladder
2-3	Connected to AGNDC_	Device is not the top-most device in the device ladder

**Table 27. Header J3 I<sup>2</sup>C Interface**

HEADER J3 (EV KIT)		HEADER P3 (MINIUSB-X)	
J3-3	SDALA	P3-3	SDA
J3-7	SCLLA	P3-7	SCL
J3-5	GNDLA	P3-5	GND
J3-1	SHDNINA*	P3-1	VDD
J3-11	SHDNA	P3-11	K1

\*Connected through jumper JU12.

**Table 28. Header J3 Pinout**

PIN NO. (ODD)	NET ASSOCIATION	PIN NO. (EVEN)	NET ASSOCIATION
1	SHDNINA	2	GNDLA
3	SDALA	4	GNDLA
5	GNDLA	6	GNDLA
7	SCLLA	8	GNDLA
9	N.C.	10	GNDLA
11	SHDNA	12	GNDLA
13	N.C.	14	GNDLA
15	N.C.	16	GNDLA
17	N.C.	18	GNDLA
19	GNDLA	20	—

All other MAX11068 devices in the SMBus ladder communicate with the host controller through the device below them, utilizing the device's level-shifted communication bus. Refer to the *I<sup>2</sup>C Interface* section in the MAX11068 IC data sheet for additional information.

### **MINIUSB Command Module**

The MINIUSB board has to be connected to the MINIUSB-XHV expander board (provided with the MINIUSB command model) before interfacing with the EV kit. The combination of the MINIUSB board and MINIUSB-XHV expander board is further referenced as the MINIUSB command module. The MINIUSB command module is powered by the host PC's USB port. Refer to the *MINIUSB User Guide* for additional information. See Table 27 for a pin-to-pin association between the MINIUSB command module and the EV kit's J3 header

The MINIUSB command module is also used to drive the shutdown pin of the first MAX11068 device in the SMBus ladder. For the EV kit, the U1 or U101 device is the first device in the SMBus ladder and their respective SHDN pin is driven by the MINIUSB command module (host controller). See Tables 28 and 29 for a complete pinout of headers J3 and J103, respectively.

# MAX11068 Evaluation System

**Table 29. Header J103 Pinout**

PIN NO. (ODD)	NET ASSOCIATION	PIN NO. (EVEN)	NET ASSOCIATION
1	$\overline{\text{SHDNIN}}$	2	GNDLB
3	SDALB	4	GNDLB
5	GNDLB	6	GNDLB
7	SCLLB	8	GNDLB
9	N.C.	10	GNDLB
11	$\overline{\text{SHDNB}}$	12	GNDLB
13	N.C.	14	GNDLB
15	N.C.	16	GNDLB
17	N.C.	18	GNDLB
19	GNDLB	20	—

**Table 30. Header J4 and J5 (U1 Fanout)**

PIN NO.	PIN NAME	
	J4	J5
1	DCINA	HVA
2	CP+A	C12A
3	CP-A	C11A
4	VDDUA	C10A
5	GNDUA	C9A
6	SCLUA	C8A
7	SDAUA	C7A
8	ALRMUA	C6A
9	N.C.	C5A
10	GPIO2A	C4A
11	GPIO1 A	C3A
12	GPIO0 A	C2A
13	VDDLA	C1A
14	GNDLA	C0A
15	SCLLA	VAAA
16	SDALA	AGNDA
17	ALRMLA	REFA
18	$\overline{\text{SHDNINA}}$	AUXIN1A
19	AUXIN2A	THRMA
20	N.C.	N.C.

### Reset

The MAX11068 device is reset when the device's VAA regulator drops below the power-on-reset (POR) threshold. A soft reset is accomplished in one of two ways, depending on the type of  $\overline{\text{SHDNIN}}$  control the EV kit is configured for (see the *Device Startup* section). A hard reset can also be initiated by cycling the power on the

**Table 31. Header J6 and J7 (U2 Fanout)**

PIN NO.	PIN NAME	
	J6	J7
1	DCINCA	CP+CA
2	HVCA	CP-CA
3	N.C.	VDDUCA
4	C12CA	GNDUCA
5	C11CA	ALRMINCA
6	C10CA	N.C.
7	C9CA	AGNDCA
8	C8CA	TOPSELCA
9	C7CA	AGNDCA
10	C6CA	AGNDCA
11	C5CA	CDCA
12	C4CA	ALRMOUTCA
13	C3CA	$\overline{\text{SHDNINCA}}$
14	C2CA	AGNDCA
15	C1CA	VAACA
16	C0CA	OVSEL3CA
17	UVSEL0CA	OVSEL2CA
18	UVSEL1CA	OVSEL1CA
19	UVSEL2CA	OVSEL0CA
20	N.C.	N.C.

DCIN input pin. After a reset, all the MAX11068 registers are restored to their POR values. Refer to the MAX11068 IC data sheet for additional details.

### Software $\overline{\text{SHDNIN}}$ Control:

- 1) Check the  $\overline{\text{SHDN}}$  checkbox.
- 2) Uncheck the  $\overline{\text{SHDN}}$  checkbox.

### Hardware $\overline{\text{SHDNIN}}$ Control:

- 1) Disconnect the  $\overline{\text{SHDNIN}}$  net from the MINIQUSB's 3.3V rail:
  - If board (A) is interfaced to the MINIQUSB command module, remove the shunt from its JU12 jumper.
  - If board (B) is interfaced to the MINIQUSB command module, remove the shunt from its JU112 jumper.
- 2) Reinstall the shunt.

### 20-Pin Header Footprints

Tables 30–33 provide the complete pinouts for each pair of the 20-pin single-row headers (J4 and J5, J6 and J7, J104 and J105, and J106 and J107) provided on the

# MAX11068 Evaluation System

EV kit. Between each pair of headers is a MAX11068 or MAX11080 device. Each MAX11068 and MAX11080 device has its pins fanned out to its associated 20-pin headers (see Figures 16a–19).

The header pairs are spaced approximately 2in apart (pin center to pin center) and accommodate a single-row 20-pin header with 0.1in centers.

### J4 and J5 Headers

The J4 and J5 header footprints provide direct access to the MAX11068 IC (U1) pins (see Table 30 for U1 fanout).

**Table 32. Headers J104 and J105 (U101 Fanout)**

PIN NO.	PIN NAME	
	J104	J105
1	DCINB	HVB
2	CP+B	C12B
3	CP-B	C11B
4	VDDUB	C10B
5	GNDUB	C9B
6	SCLUB	C8B
7	SDAUB	C7B
8	ALRMUB	C6B
9	N.C.	C5B
10	GPIO2B	C4B
11	GPIO1 B	C3B
12	GPIO0 B	C2B
13	VDDL B	C1B
14	GNDLB	C0B
15	SCLLB	VAAB
16	SDALB	AGNDB
17	ALRMLB	REFB
18	SHDNINB	AUXIN1B
19	AUXIN2B	THRMB
20	N.C.	N.C.

### J6 and J7 Headers

The J6 and J7 header footprints provide direct access to the MAX11080 IC (U2) pins (see Table 31 for U2 fanout).

### J104 and J105 Headers

The J104 and J105 header footprints provide direct access to the MAX11068 IC (U101) pins (see Table 32 for U101 fanout).

### J106 and J107 Headers

The J106 and J107 header footprints provide direct access to the MAX11080 IC (U102) pins (see Table 33 for U102 fanout).

**Table 33. Headers J106 and J107 (U102 Fanout)**

PIN NO.	PIN NAME	
	J106	J107
1	DCINCB	CP+CB
2	HVCB	CP-CB
3	N.C.	VDDUCB
4	C12CB	GNDUCB
5	C11CB	ALRMINCB
6	C10CB	N.C.
7	C9CB	AGNDCB
8	C8CB	TOPSELCB
9	C7CB	AGNDCB
10	C6CB	AGNDCB
11	C5CB	CDCB
12	C4CB	ALRMOUTCB
13	C3CB	SHDNINCB
14	C2CB	AGNDCB
15	C1CB	VAACB
16	C0CB	OVSEL3CB
17	UVSEL0CB	OVSEL2CB
18	UVSEL1CB	OVSEL1CB
19	UVSEL2CB	OVSEL0CB
20	N.C.	N.C.

Evaluates: MAX11068

# MAX11068 Evaluation System

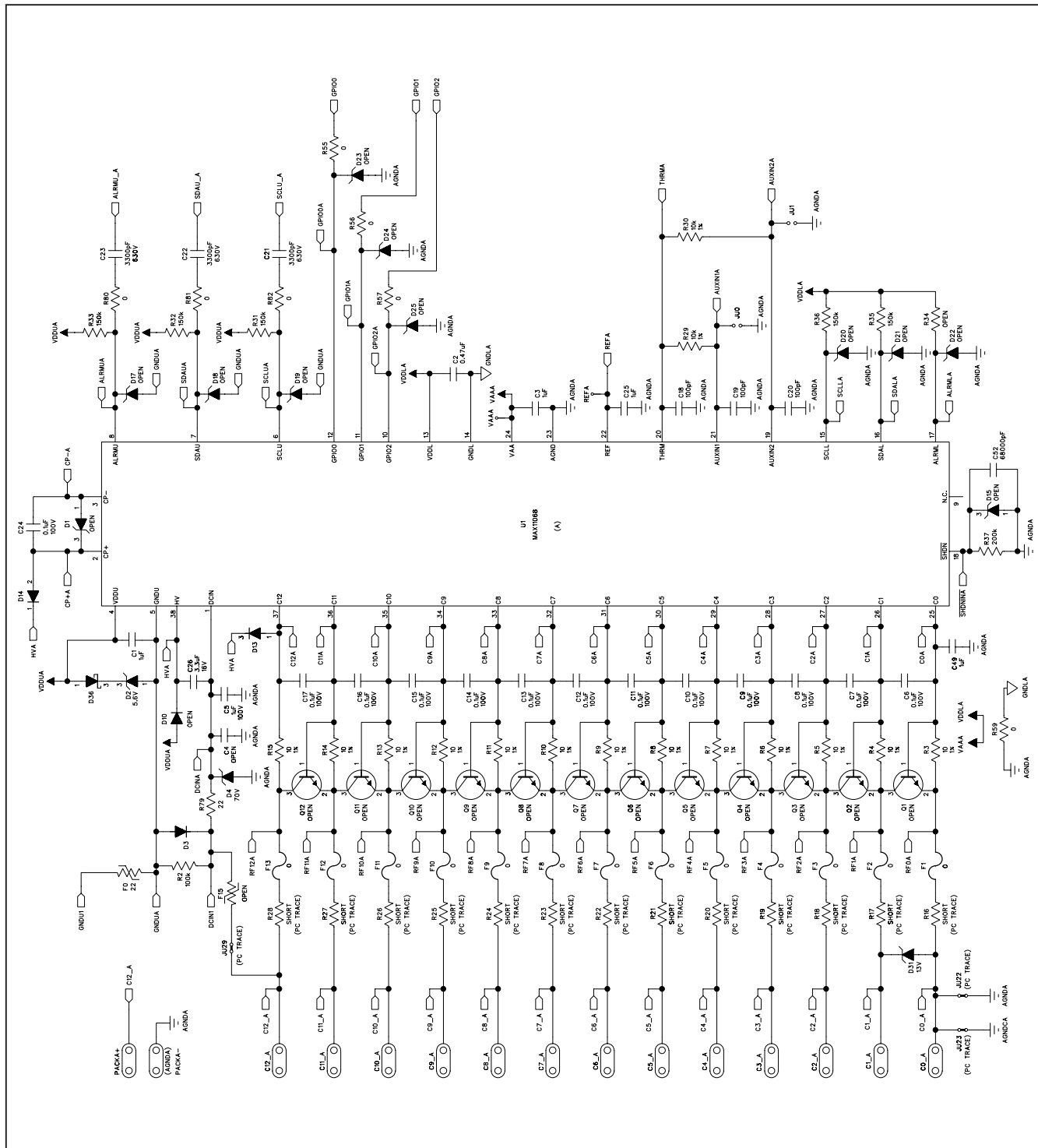

Figure 16a. MAX11068 EV Kit Schematic (Side A)—MAX11068 IC Circuit (U1)



# MAX11068 Evaluation System

Evaluates: MAX11068

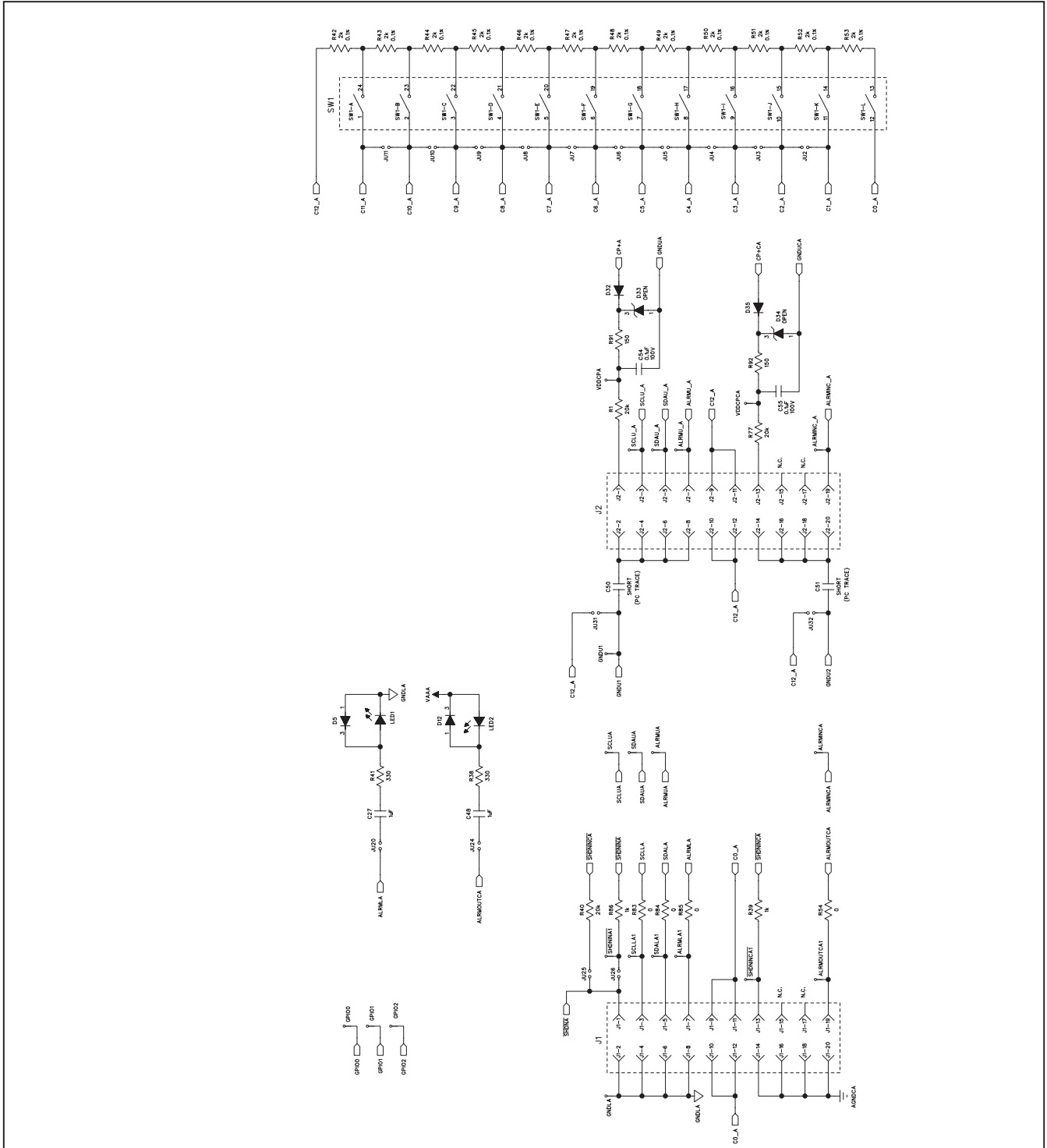

Figure 16b. MAX11068 EV Kit Schematic (Side A)—Cell Configuration, ALRMLA and ALRMOUTCA Circuits, GPIO Test Points, and Headers J1 and J2

# MAX11068 Evaluation System

Evaluates: MAX11068

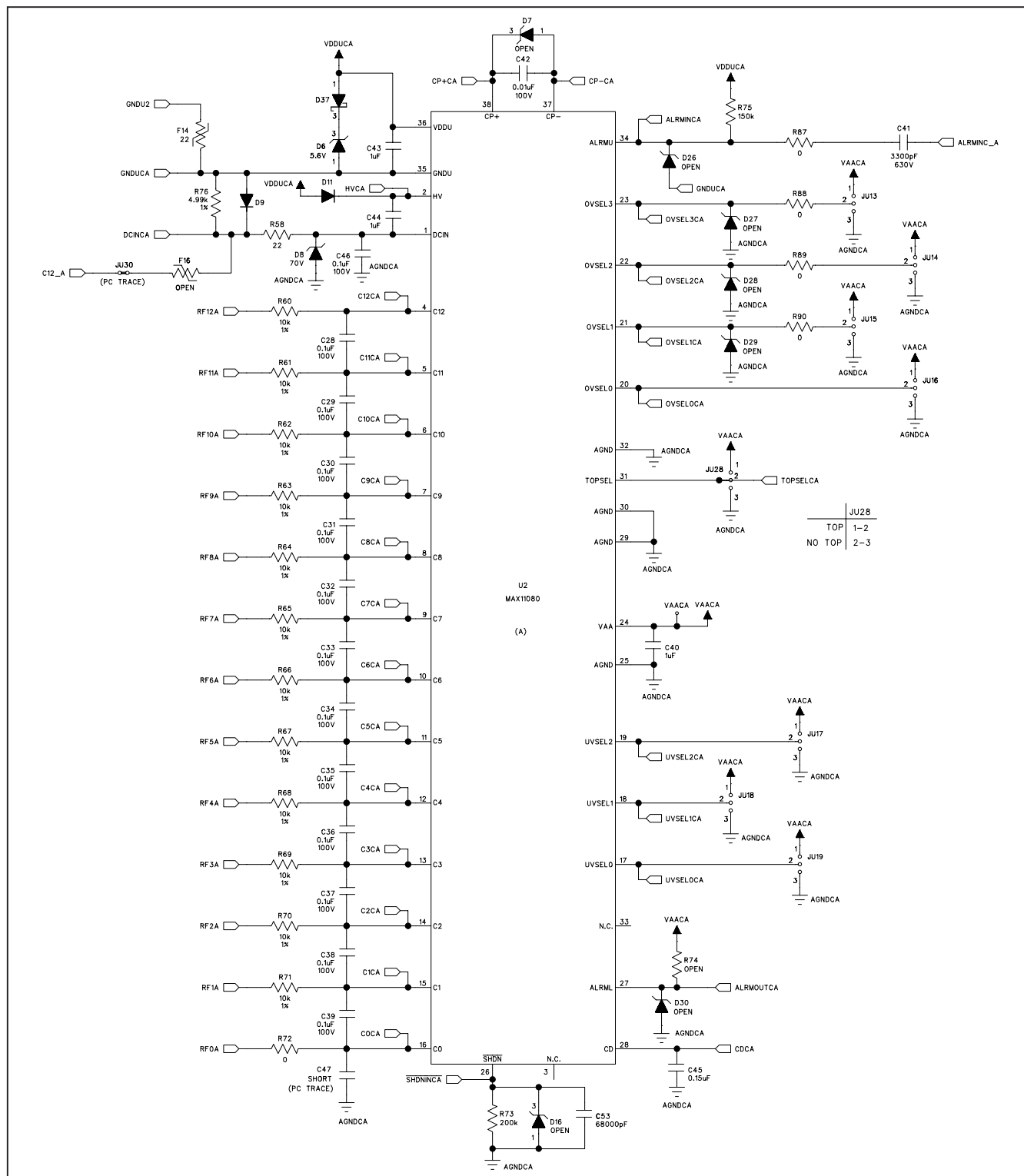

Figure 16c. MAX11068 EV Kit Schematic (Side A)—MAX11080 IC Circuit (U2)

# MAX11068 Evaluation System

Evaluates: MAX11068

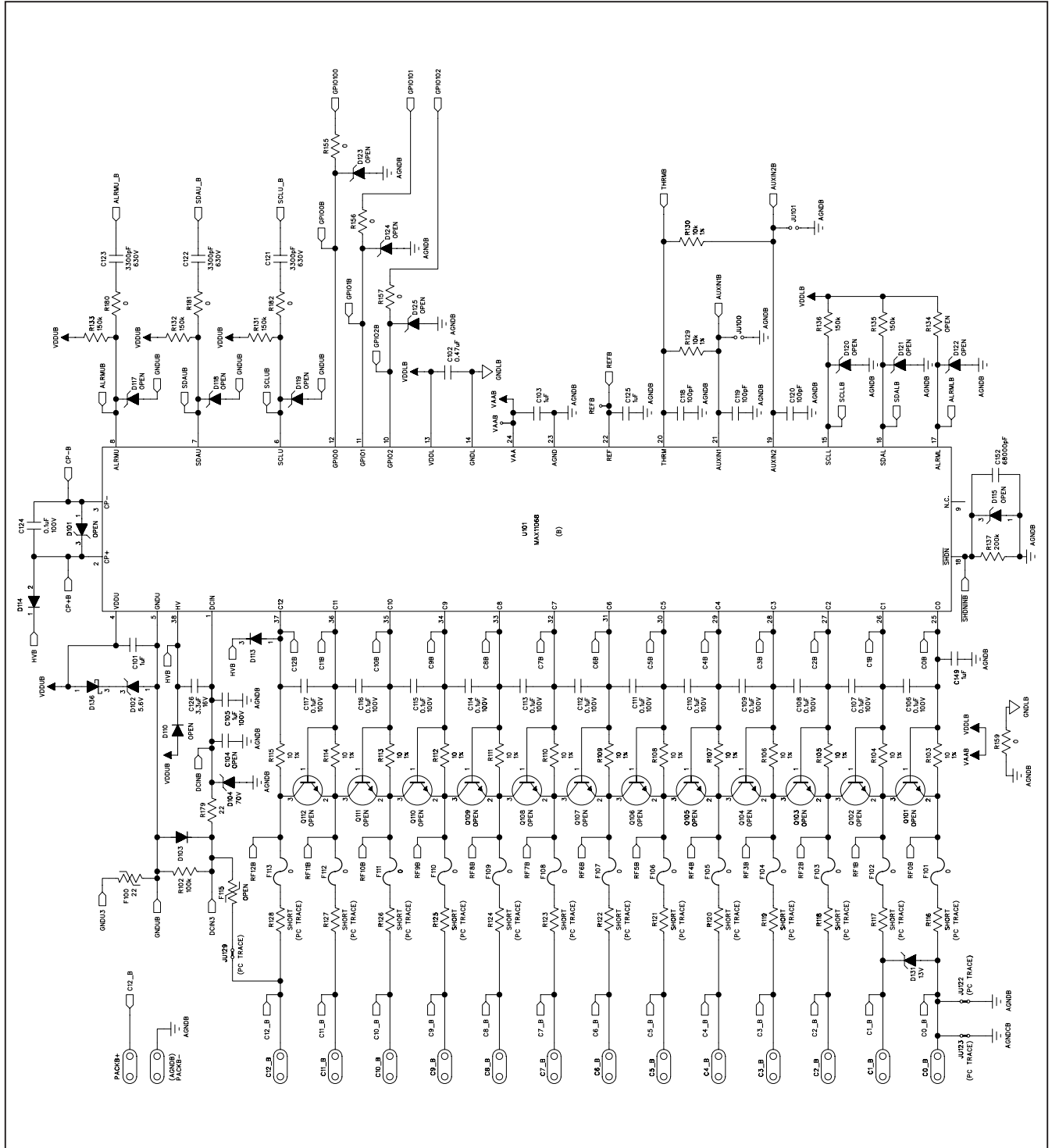

Figure 17a. MAX11068 EV Kit Schematic (Side B)—MAX11068 IC Circuit (U101)

# MAX11068 Evaluation System

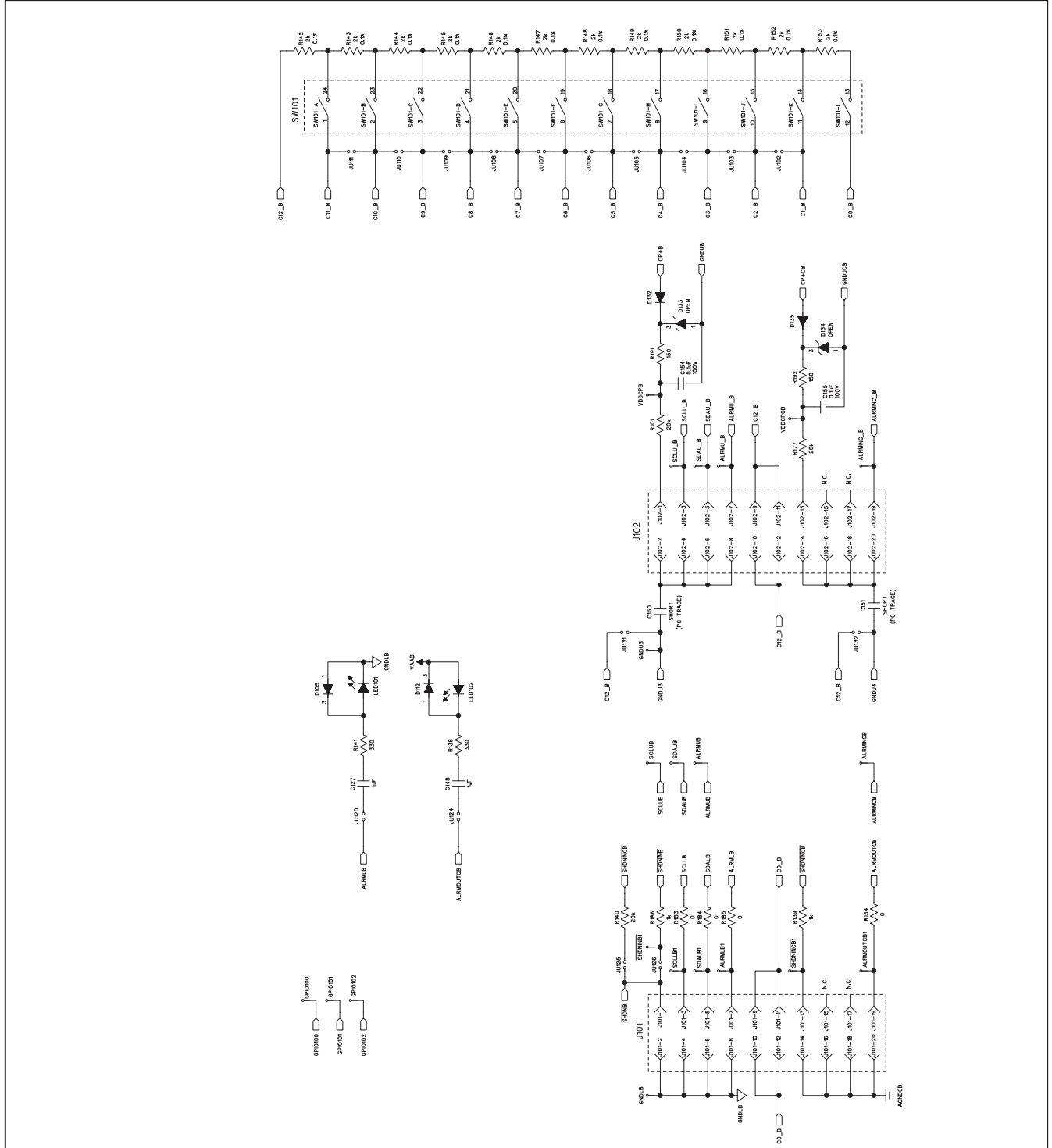

Figure 17b. MAX11068 EV Kit Schematic (Side B)—Cell Configuration, ALRMLB and ALRMOUTCB Circuits, GPIO Test Points, and Headers (J101 and J102)

# MAX11068 Evaluation System

Evaluates: MAX11068

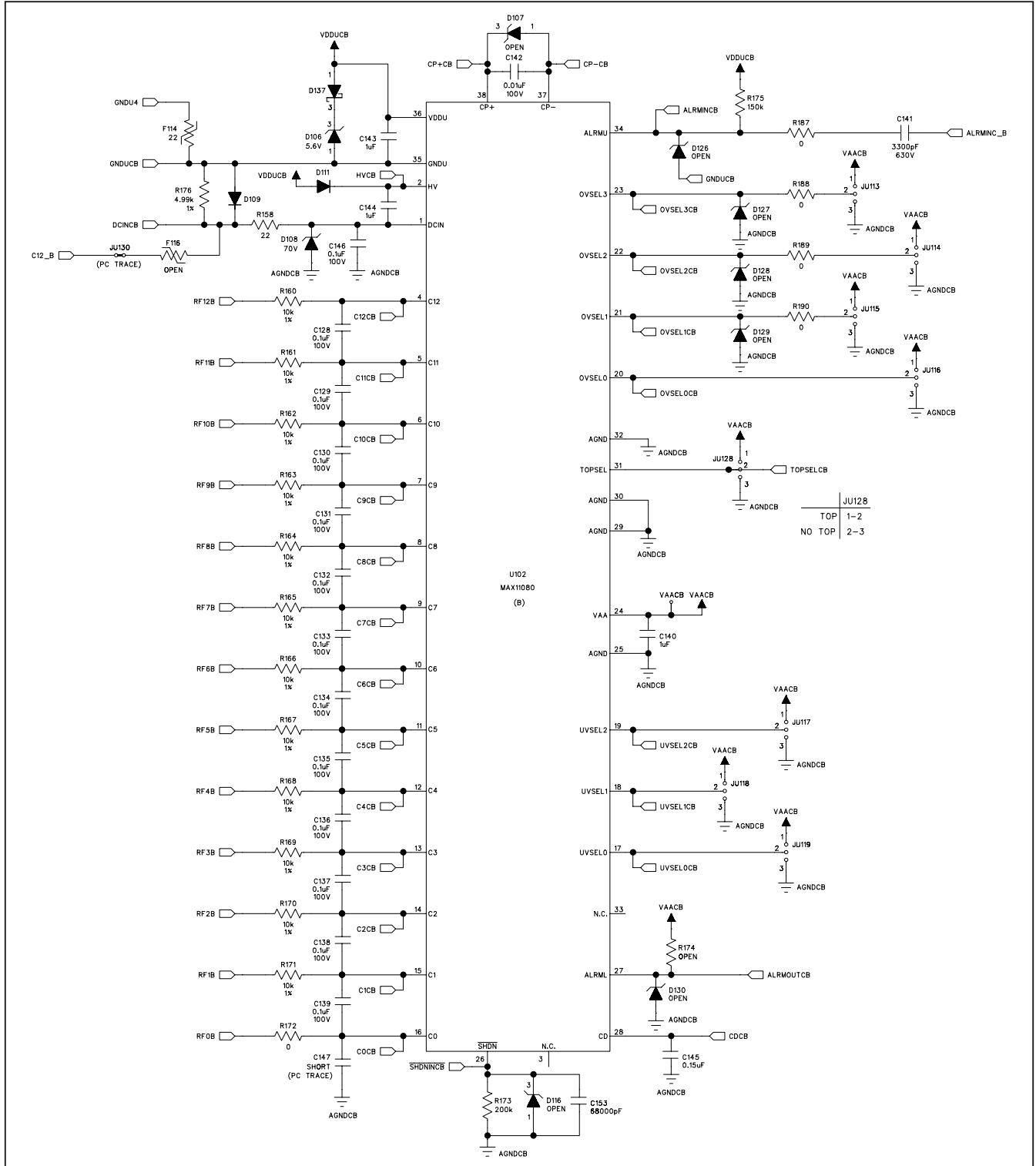

Figure 17c. MAX11068 EV Kit Schematic (Side B)—MAX11080 IC Circuit (U102)

# MAX11068 Evaluation System

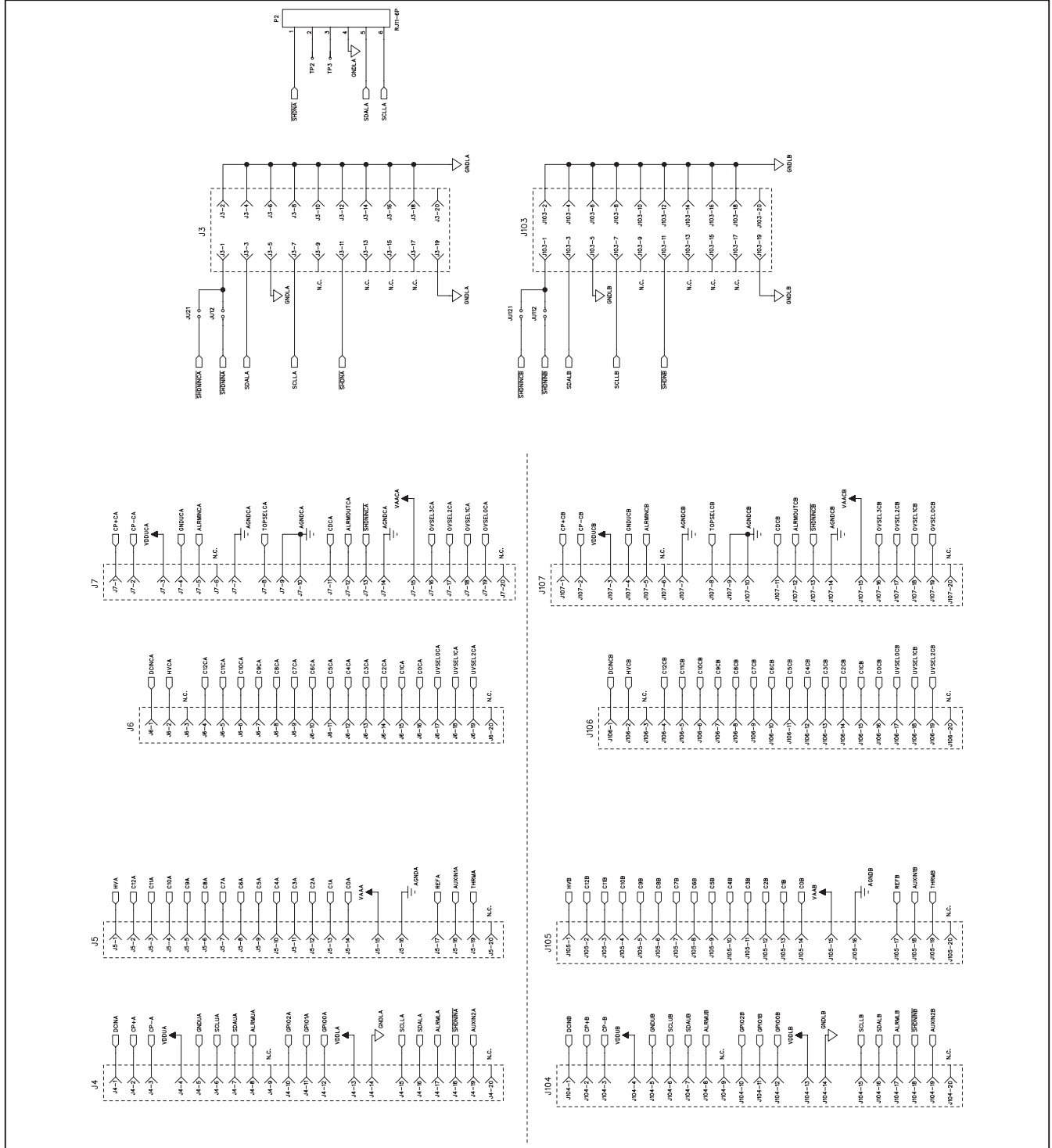

Figure 18. MAX11068 EV Kit Schematic (Interface Headers)—20-Pin Single-Row Headers (J4–J7 and J104–J107), Connector P2, and Interface Headers (J3 and J103)



# MAX11068 Evaluation System

Evaluates: MAX11068

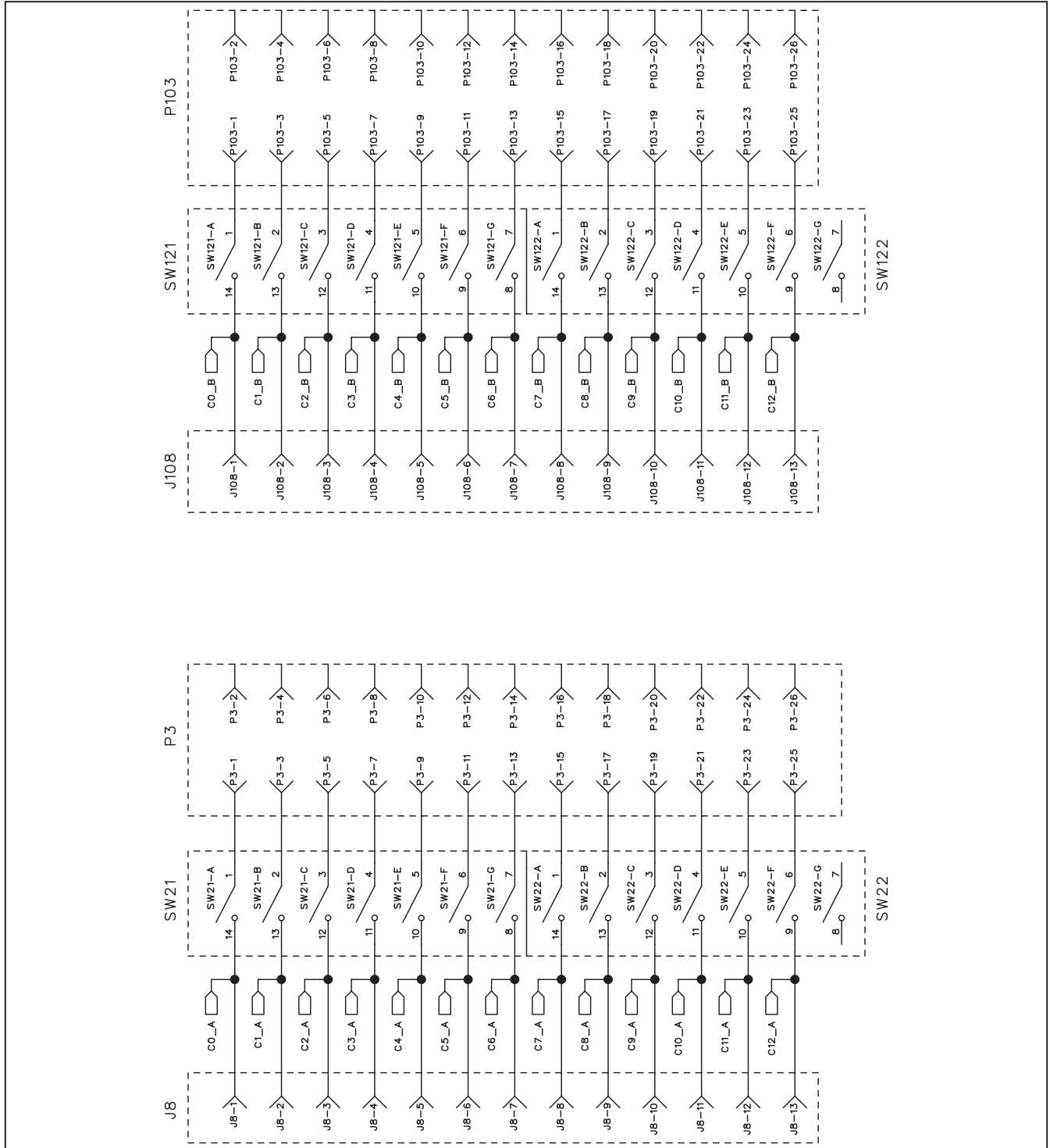

Figure 19. MAX11068 EV Kit Schematic (Cell-Connection Switches and Headers)—7-Position Switches (SW21, SW22, SW121, and SW122) and Headers (J8 and J108)

# MAX11068 Evaluation System

Evaluates: MAX11068

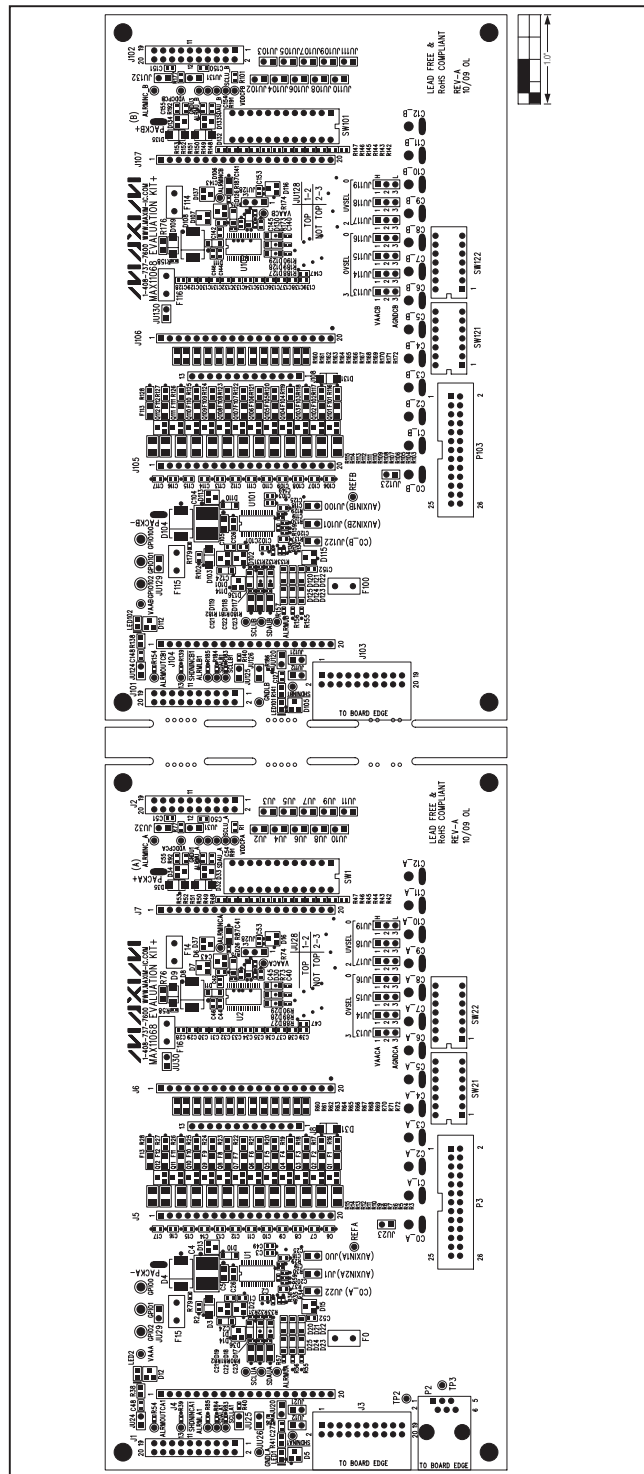

Figure 20. MAX11068 EV Kit Component Placement Guide—Component Side

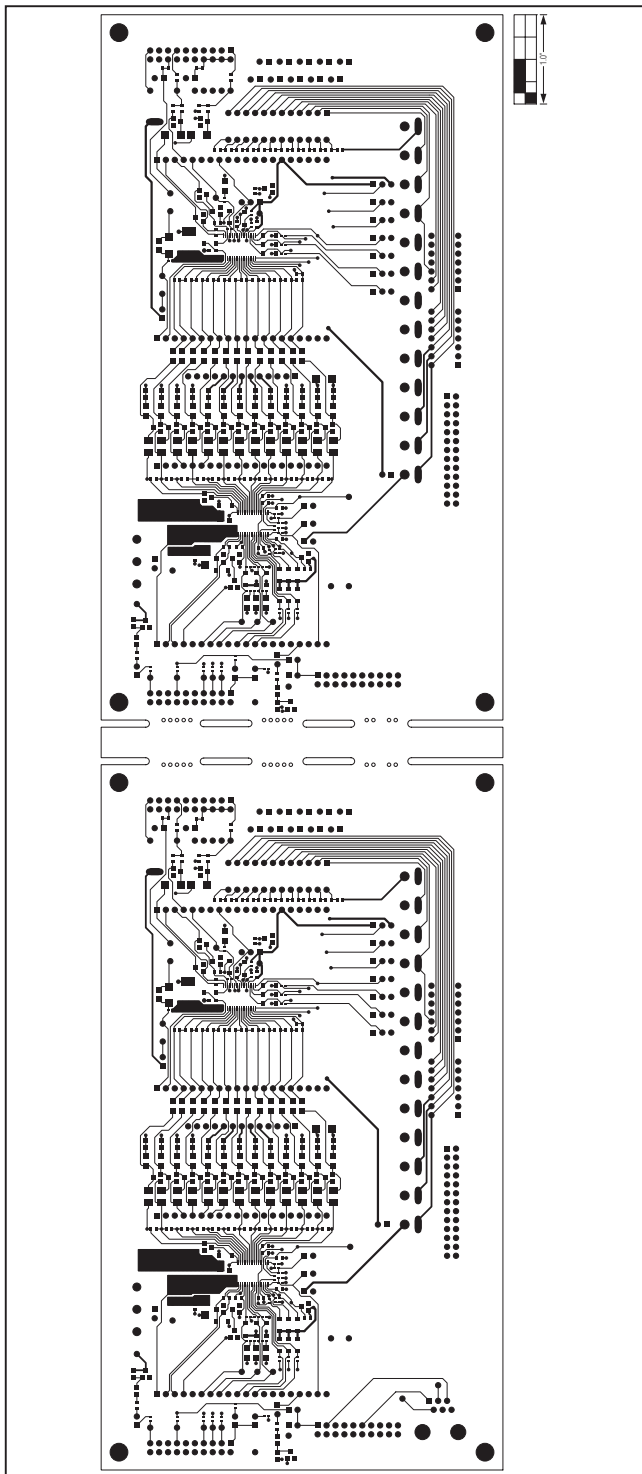

Figure 21. MAX11068 EV Kit PCB Layout—Component Side

# MAX11068 Evaluation System

Evaluates: MAX11068

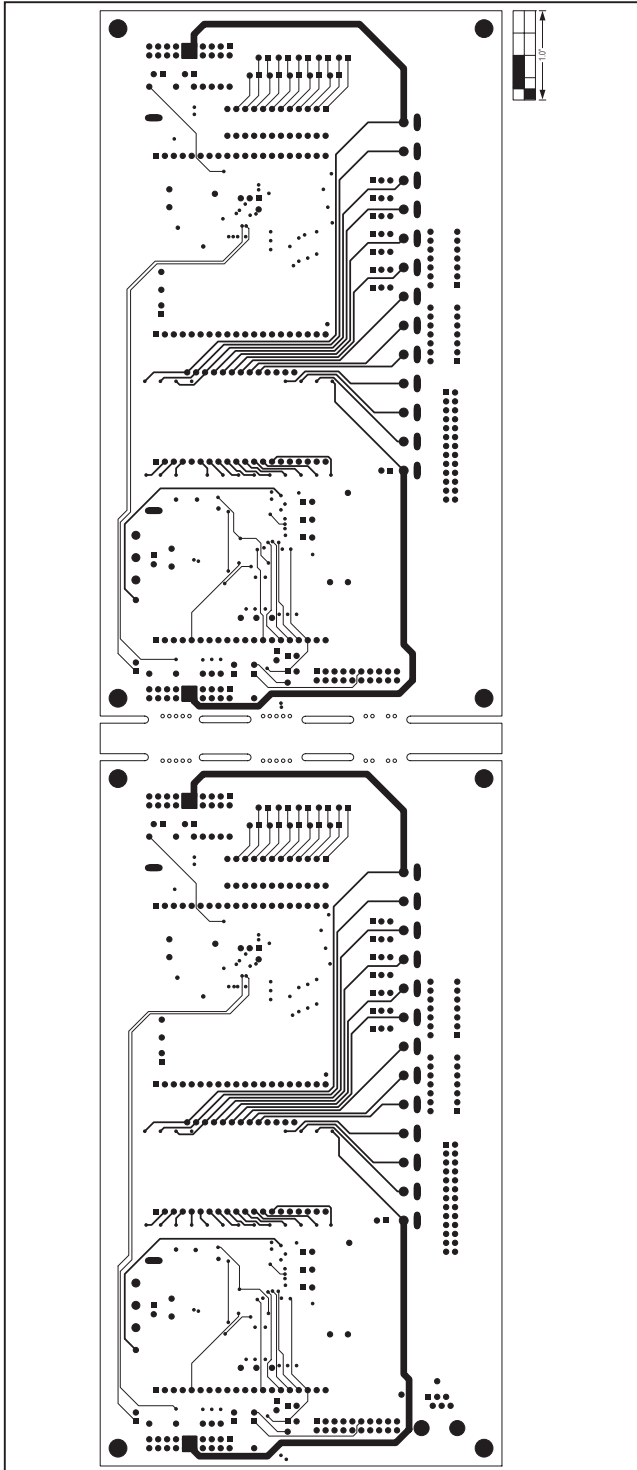

Figure 22. MAX11068 EV Kit PCB Layout—Internal Layer 2

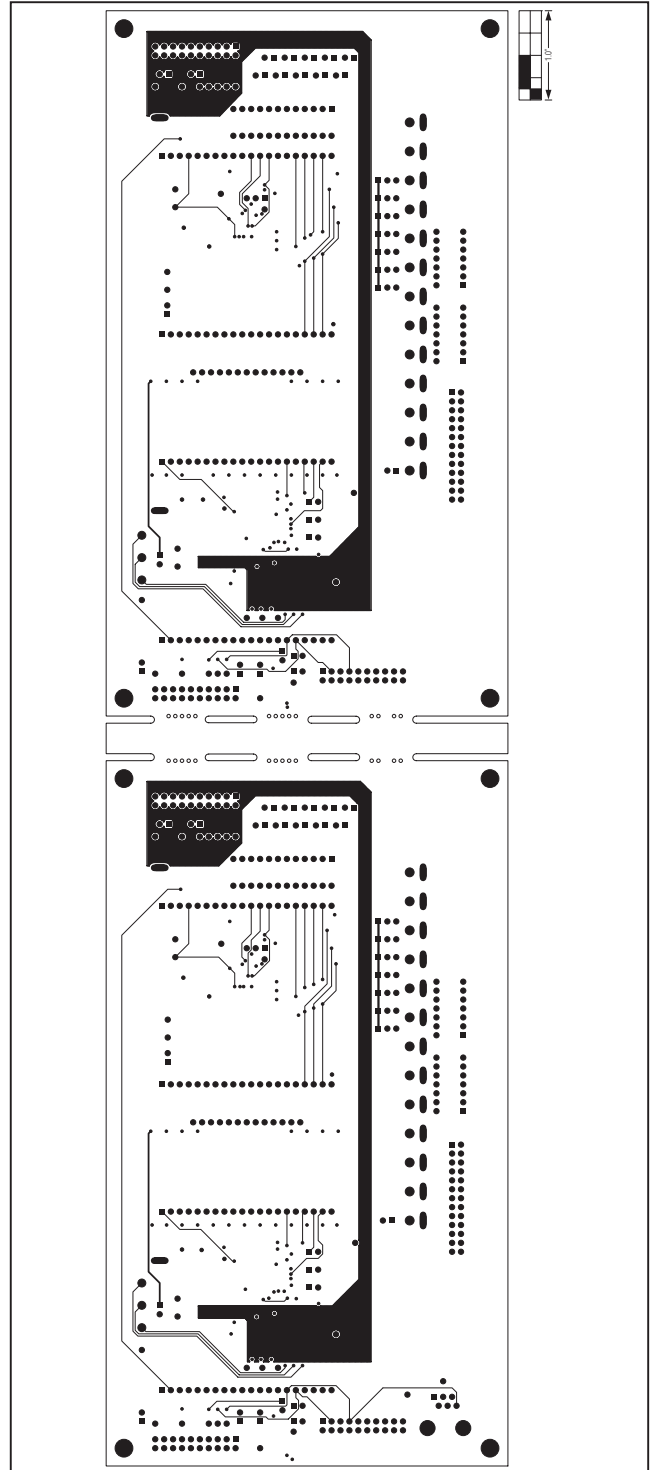

Figure 23. MAX11068 EV Kit PCB—Internal Layer 3

# MAX11068 Evaluation System

Evaluates: MAX11068

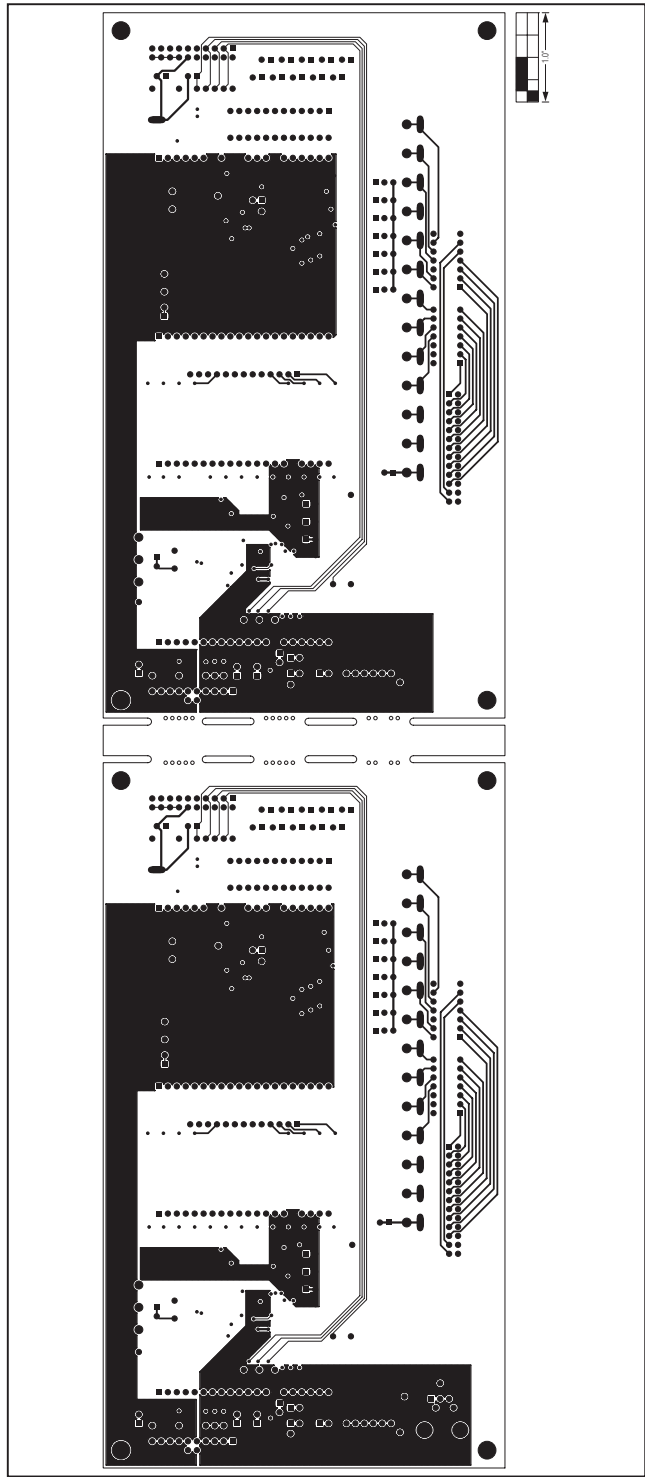

Figure 24. MAX11068 EV Kit PCB Layout—Solder Side

# MAX11068 Evaluation System

## Revision History

REVISION NUMBER	REVISION DATE	DESCRIPTION	PAGES CHANGED
0	12/09	Initial release	—
1	10/10	Updated <i>Component List</i> and <i>Component Suppliers</i> , and Tables 1, 2, and 15; <i>Threshold Tab</i> , <i>AIN1/DIAG/FMEA Tab</i> , <i>Cell Configuration</i> , and <i>Alarm Monitoring</i> sections; and Figures 6, 10, 16a, 16c, 17a, and 17c	3, 4, 6, 11, 12, 17, 24, 25, 27, 32, 34, 35, 37

Evaluates: MAX11068

Maxim cannot assume responsibility for use of any circuitry other than circuitry entirely embodied in a Maxim product. No circuit patent licenses are implied. Maxim reserves the right to change the circuitry and specifications without notice at any time.

Maxim Integrated Products, 120 San Gabriel Drive, Sunnyvale, CA 94086 408-737-7600 \_\_\_\_\_ 43