

DATA SHEET

Interface cable

USB 3.0 Type-A to Micro-B with screw locks, 8.0 m

Product code
12329

V1.0.0
2019-May-17



NOTICE

Malfunctions and short circuits by damaged cables and connectors

Provide sufficient strain relief for all cable connections.

Cable and connector dimensions

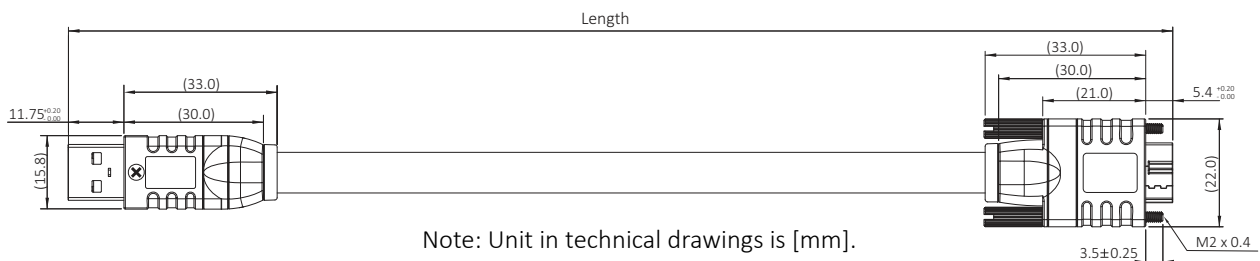

Connector 1:
USB 3.0 Type-A male

Cable

Connector 2:
USB 3.0 Micro-B male

Connector 1 and adapter description

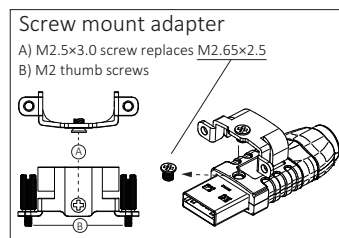
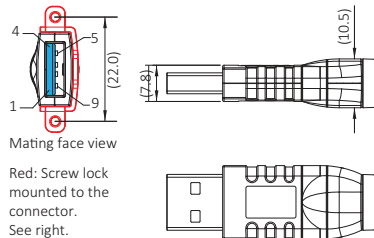

Connector 2 description

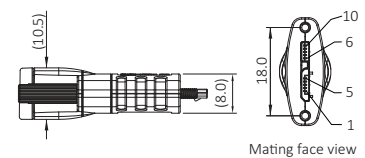

Wiring diagram

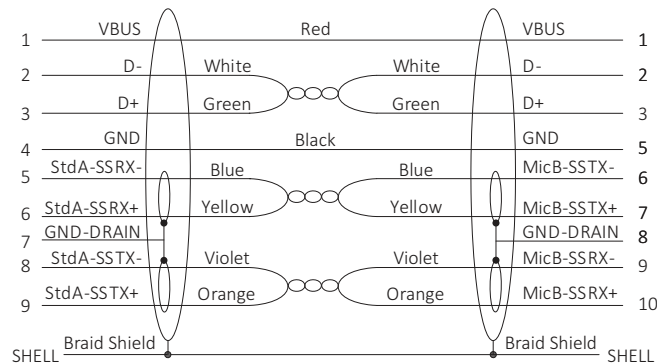

Specifications

Feature	Specification
Length	8.0 m ± 100 mm
Diameter	8.0 mm
Classifications	Industrial grade for static applications
Static bending radius	≥ 62 mm
Dynamic bending radius	For static applications only
Operating temperature range	-10°C to +60°C
Regulations	2011/65/EU, incl. amendment 2015/863/EU (RoHS), China RoHS, REACH, cable material: UL2725