

**SERIES:** PRF20 | **DESCRIPTION:** DC-DC CONVERTER

**FEATURES**

- up to 20 W isolated output
- 4:1 input range (43~160 V)
- smaller package
- single/dual regulated outputs
- meets European EN50155 railway standard
- 2,250 Vdc isolation
- continuous short circuit, over current protection, over voltage protection
- built-in remote on/off
- wide operating temperature range (-40~85°C)
- efficiency up to 90%



MODEL	input voltage		output voltage	output current		output power	ripple and noise <sup>1</sup>	efficiency
	typ (Vdc)	range (Vdc)	(Vdc)	min (mA)	max (mA)	max (W)	max (mVp-p)	typ (%)
PRF20-Q110-S5	110	43~160	5	0	4000	20	75	88.5
PRF20-Q110-S12	110	43~160	12	0	1670	20	100	90
PRF20-Q110-S15	110	43~160	15	0	1330	20	100	89.5
PRF20-Q110-D12	110	43~160	±12	0	±833	20	100	89
PRF20-Q110-D15	110	43~160	±15	0	±667	20	100	88.5

Note: 1. Ripple and noise are measured at 20 MHz BW by and 1µF ceramic capacitor across each output.

**PART NUMBER KEY**

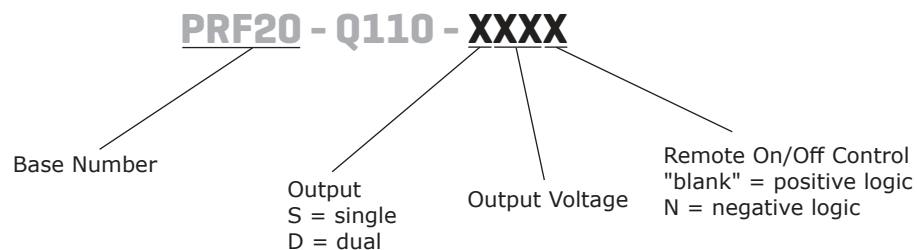

## INPUT

parameter	conditions/description	min	typ	max	units
operating input voltage		43	110	160	Vdc
under voltage shutdown	power up		40		Vdc
	power down		38		Vdc
surge voltage	for maximum of 100 ms			200	Vdc
start-up time	single output models		15		ms
	dual output models		25		ms
remote <sup>1</sup>	positive logic	models ON (open or 3.5~75 Vdc)			
		models OFF (0~1.2 Vdc)			
	negative logic	models ON (0~1.2 Vdc)			
		models OFF (open or 3.5~75 Vdc)			
filter	pi filter				

Note: 1. Open collector refer to -Vin.

## OUTPUT

parameter	conditions/description	min	typ	max	units
maximum capacitive load	5V output model			5600	μF
	12V output model			1000	μF
	15V output model			1000	μF
	±12V output model			±680	μF
	±15V output model			±350	μF
line regulation	from high line to low line			±0.2	%
load regulation	from full load to no load			±0.5	%
	single output models			±1	%
cross regulation	dual output models, load cross variation 10%/100%			±5	%
voltage accuracy				±1.5	%
adjustability <sup>2</sup>			±10		%
switching frequency			250		KHz
transient response	25% load step change			250	μs
temperature coefficient				±0.03	%/°C

Note: 2. Output trimming available on single output models only

## PROTECTIONS

parameter	conditions/description	min	typ	max	units
short circuit protection	continuous				
over current protection		110		160	%
over voltage protection	protected by internal zener or TVS clamp				
	5V output model		6.2		Vdc
	12V output model		15		Vdc
	15V output model		18		Vdc
	±12V output model		±15		Vdc
	±15V output model		±18		Vdc

## SAFETY AND COMPLIANCE

parameter	conditions/description	min	typ	max	units
isolation voltage	input to output for 1 minute	2,250			Vdc
isolation resistance		1000			MΩ
safety approvals	UL60950-1				
EMI/EMC	EN55022 class A, EN50155 (external circuit required)				
RoHS	2011/65/EU				

## ENVIRONMENTAL

parameter	conditions/description	min	typ	max	units
operating temperature	see derating curve	-40		85	°C
storage temperature		-55		125	°C
humidity	non-condensing			95	%
case temperature				105	°C
vibration	EN50155 (EN61373)				

## SOLDERABILITY

parameter	conditions/description	min	typ	max	units
wave soldering	see wave soldering profile			260	°C

- Notes:
1. Soldering materials: Sn/Cu/Ni
  2. Ramp up rate during preheat: 1.4°C/s (from 50°C to 100°C)
  3. Soaking temperature: 0.5°C/s (from 100°C to 130°C), 60±20 seconds
  4. Peak temperature: 260°C, above 250°C for 3~6 seconds
  5. Ramp down rate during cooling: -10°C/s (from 260°C to 150°C)

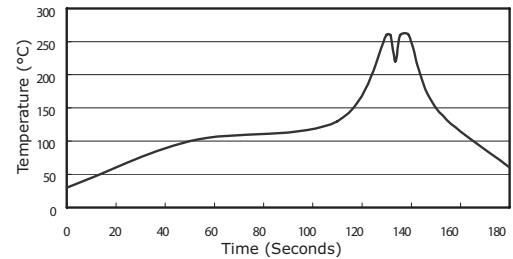

## MECHANICAL

parameter	conditions/description	min	typ	max	units
dimensions	2.00 x 1.00 x 0.40 (50.8 x 25.4 x 10.2 mm)				inch
case material	black coated copper with non-conductive base				
weight			35		g

## MECHANICAL DRAWING

units: inch[mm]

tolerance: X.XX = ±0.02[±0.5]

X.XXX = ±0.010[±0.25]

1.3 mm Plated Through hole  
2.5 mm Pad Size

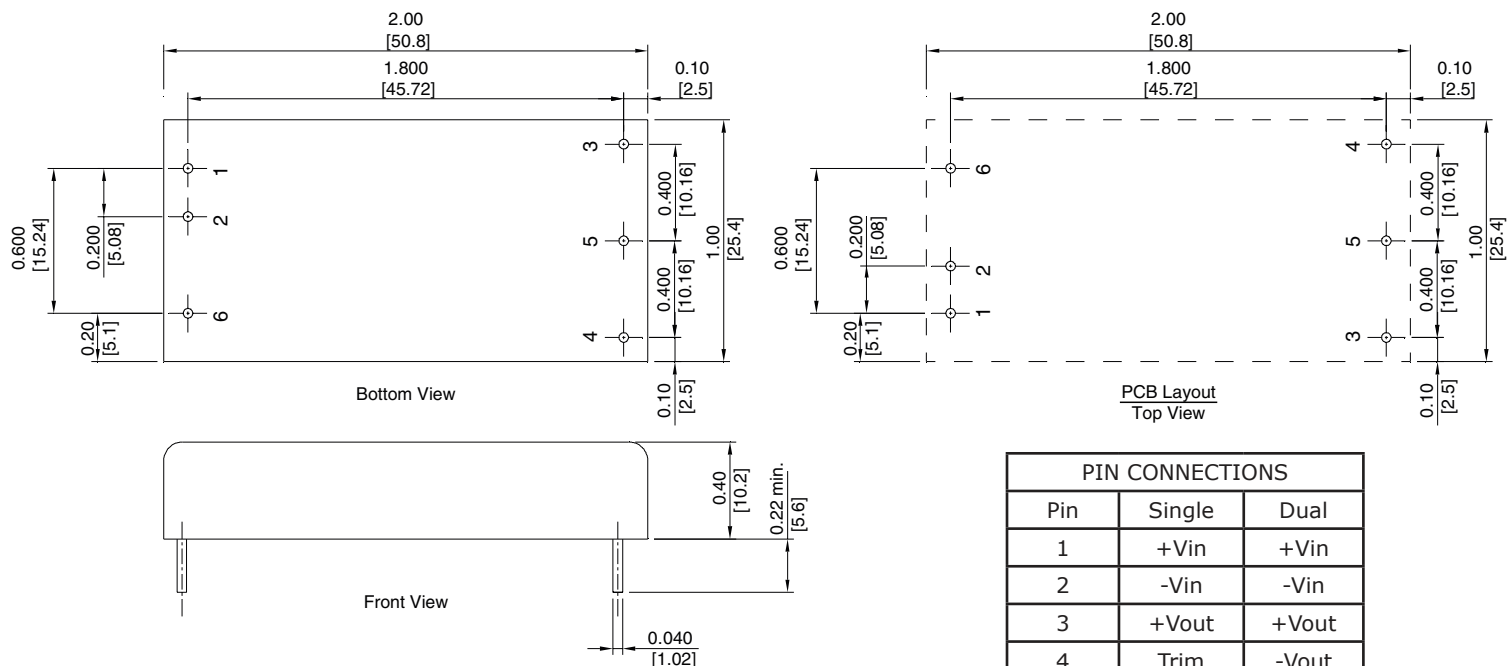

PIN CONNECTIONS		
Pin	Single	Dual
1	+Vin	+Vin
2	-Vin	-Vin
3	+Vout	+Vout
4	Trim	-Vout
5	-Vout	common
6	Remote ON/OFF	

## DERATING CURVES

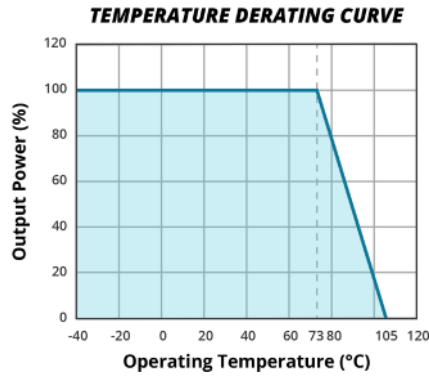

## EMC RECOMMENDED CIRCUIT

EN50155[EN50121-3-2]

Figure 1

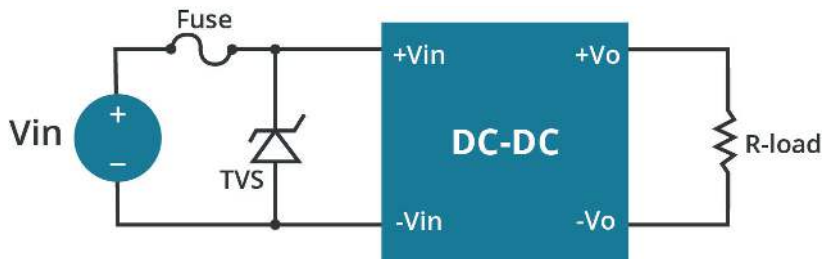

Table 1

External components
3A time delay fuse
TVS

## TEST CONFIGURATION

Figure 2

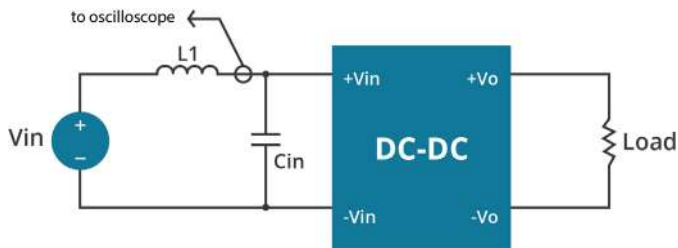

Table 2

External components	
Lin	12μH
Cin	22μF, ESR < 0.2Ω at 100 KHz

Note: Input reflected-ripple current is measured with an inductor L1 to simulate source impedance.

## APPLICATION NOTES

### Output Voltage Trimming

Leave open if not used.

**Figure 3**

Application Circuit for Trim pin

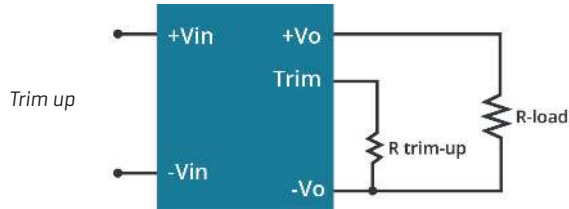

Formula for Trim Resistor

$$R_{trim - up} = \left( \frac{V_r \times R1 \times (R2 + R3)}{(V_o - V_{o, nom}) \times R2} \right) - R_t \text{ (K}\Omega\text{)}$$

$$R_{trim - down} = R1 \times \left( \frac{V_r \times R1}{(V_{o, nom} - V_o) \times R2} - 1 \right) - R_t \text{ (K}\Omega\text{)}$$

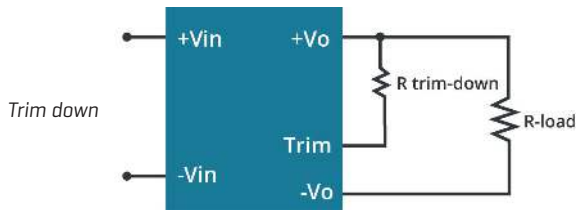

Note:  $R_{trim-up}$  is the external resistor in  $K\Omega$   
 $R_{trim-down}$  is the external resistor in  $K\Omega$   
 $V_{o, nom}$  is the nominal output voltage  
 $V_o$  is the desired output voltage  
 $R1, R2, R3, R_t,$  and  $V_r$  are internal (see table 3).

**Table 3**

Vout (Vdc)	R1 (KΩ)	R2 (KΩ)	R3 (KΩ)	Rt (KΩ)	Vr (V)
5	2.32	2.32	0	8.2	2.5
12	6.8	2.4	2.32	22	2.5
15	8.06	2.4	3.9	27	2.5

Note: 1. All specifications are measured at Ta=25°C, nominal input voltage and full output load unless otherwise specified.

## REVISION HISTORY

rev.	description	date
1.0	initial release	02/12/2014
1.01	company logo updated	02/16/2021
1.02	derating curve and circuit figures updated	08/23/2021
1.03	input section updated	03/10/2022

The revision history provided is for informational purposes only and is believed to be accurate.



**CUI INC**  
a bel group

**Headquarters**  
20050 SW 112th Ave.  
Tualatin, OR 97062  
**800.275.4899**

Fax 503.612.2383  
**cui.com**  
techsupport@cui.com

CUI offers a two (2) year limited warranty. Complete warranty information is listed on our website.

CUI reserves the right to make changes to the product at any time without notice. Information provided by CUI is believed to be accurate and reliable. However, no responsibility is assumed by CUI for its use, nor for any infringements of patents or other rights of third parties which may result from its use.

CUI products are not authorized or warranted for use as critical components in equipment that requires an extremely high level of reliability. A critical component is any component of a life support device or system whose failure to perform can be reasonably expected to cause the failure of the life support device or system, or to affect its safety or effectiveness.