

TPS92692 Boost and Boost-to-Battery LED Driver Evaluation Board

This user's guide describes the characteristics, operation, and use of the TPS92692 Boost and Boost-to-Battery Evaluation Module (EVM). A complete schematic diagram, printed-circuit board layouts, and bill of materials are included in this document.

Contents

1	Introduction	3
2	Description	3
	2.1 Typical Applications	3
	2.2 Features.....	3
3	Connector Description.....	4
	3.1 J2, Low Brightness, Full Brightness, GND	4
	3.2 Configuring for Boost or Boost-to-Battery (J1, J3)	4
	3.3 J4, Fault Response Setting.....	5
	3.4 J5, IADJ Input Select	5
	3.5 PWM Dimming (J6, J7)	5
	3.6 J8, Dither Modulation Setting	5
	3.7 TP2, Soft Start	5
	3.8 TP8, PWM	6
	3.9 TP7, IADJ.....	6
	3.10 TP6, IMON.....	6
4	Boost LED Driver Electrical Performance Specifications.....	6
5	Boost LED Driver Schematic	7
6	Performance Data and Typical Characteristic Curves	8
	6.1 Efficiency.....	8
	6.2 Line Regulation	9
	6.3 Load Regulation	10
	6.4 Temperature Characteristics.....	11
	6.5 Analog Adjust Settings.....	11
	6.6 Analog-to-PWM Dimming	11
	6.7 Direct External PWM Dimming	12
	6.8 Typical Waveforms	12
	6.9 EMI	14
7	Buck-Boost LED Driver Electrical Performance Specifications	15
8	Buck-Boost LED Driver Schematic.....	16
9	Performance Data and Typical Characteristic Curves.....	17
	9.1 Efficiency	17
	9.2 Line Regulation	17
	9.3 Load Regulation	18
	9.4 Typical Waveforms.....	18
10	TPS92692EVM-880 Assembly Drawing and PCB layout.....	19
11	Bill of Materials	21

List of Figures

1	Connection Diagram.....	4
2	TPS92692EVM-880 Schematic: Configured as a Boost LED Driver	7

3	Efficiency vs Input Voltage (Number of Series-Connected LEDs = 8).....	8
4	Efficiency vs Input Voltage (Number of Series-Connected LEDs = 13)	8
5	Efficiency vs Input Voltage (Number of Series-Connected LEDs = 18)	8
6	Output LED Current vs Input Voltage ($V_{IADJ} = 420\text{ mV}$)	9
7	Output LED Current vs Input Voltage ($V_{IADJ} = 1.26\text{ V}$)	9
8	Output LED Current vs Input Voltage ($V_{IADJ} = 2.1\text{ V}$)	9
9	Output LED Current vs LED String Configuration ($V_{IADJ} = 420\text{ mV}$)	10
10	Output LED Current vs LED String Configuration ($V_{IADJ} = 1.26\text{ V}$).....	10
11	Output LED Current vs LED String Configuration ($V_{IADJ} = 2.1\text{ V}$)	10
12	LED Current vs Ambient Temperature ($V_{IN} = 13\text{ V}$, Number of LEDs in Series = 8).....	11
13	LED Current vs DIM/PWM Voltage ($V_{IADJ} = 1.49\text{ V}$, Number of LEDs in Series = 13)	12
14	Normal Operation	12
15	Spread Spectrum Frequency Modulation	12
16	Startup Transient	12
17	Analog-to-PWM Dimming Transient	12
18	Direct PWM Dimming Transient.....	12
19	PWM Dimming Transient (Zoomed)	12
20	LED Open-Circuit Fault.....	13
21	LED Short-Circuit Fault.....	13
22	Conducted EMI Based on CISPR 25 Class 3 Limits (Dither Modulation Enabled).....	14
23	TPS92692EVM-880 Schematic: Configured as a Buck-Boost LED Driver	16
24	Efficiency vs Input Voltage (Number of Series-Connected LEDs = 7)	17
25	Output LED Current vs Input Voltage ($V_{IADJ} = 1.26\text{ V}$)	17
26	Output LED Current vs LED String Configuration ($V_{IADJ} = 1.26\text{ V}$).....	18
27	LED Short-Circuit Fault.....	18
28	LED Open-Circuit Fault.....	18
29	Assembly Drawing	19
30	Top Layer and Top Overlay (Top View).....	19
31	Bottom Layer and Bottom Overlay (Bottom View)	20

List of Tables

1	TPS92692EVM-880 Boost Configuration Electrical Performance Specifications	6
2	TPS92692EVM-880 Buck-Boost Configuration Electrical Performance Specifications	15
3	Bill of Materials	21

Trademarks

All trademarks are the property of their respective owners.

1 Introduction

The TPS92692EVM-880 evaluation module (EVM) helps designers evaluate the operation and performance of the TPS92692-Q1 and TPS92692: high-accuracy LED controllers designed for automotive lighting and general illumination applications. The TPS92692EVM-880 uses the TPS92692-Q1 (AEC Q100) device; however, for general illumination and other non-automotive applications, the TPS92692 is available in the same package and pin configuration and with identical performance characteristics. The TPS92692-Q1 device implements a fixed-frequency peak current mode control technique with programmable switching frequency, slope compensation, and startup timing. It incorporates a low offset rail-to-rail current sense amplifier that can directly measure LED current over an output voltage range of 0 V to 65 V. Additional features include wide input voltage range (4.5 V to 65 V), spread spectrum frequency modulation, analog-to-PWM translation circuit, direct PWM dimming capability, analog dimming capability, adjustable switching frequency, input undervoltage protection, output overvoltage protection, and switch cycle-by-cycle current limit. The controller can be used to implement a range of LED driver topologies including Boost, Buck-Boost (Boost-to-Battery), SEPIC, and Flyback, based on the output LED stack voltage.

2 Description

The TPS92692EVM-880 is a fully assembled and tested LED driver that can be configured as either a Boost or a Boost-to-Battery topology to power a single string of series-connected LEDs. High accuracy, closed-loop LED current regulation is achieved using a low-offset rail-to-rail current sense amplifier along with high-side current-sensing implementation. The DC LED current set point can be varied over a 15:1 ratio using the high-impedance analog adjust (IADJ) input. PWM dimming of LED current is achieved by directly modulating the DIM/PWM input pin with the desired duty cycle or by enabling the internal PWM generator circuit. The optional PDRV gate driver output can be used to drive an external P-Channel series MOSFET.

The TPS92692 and TPS92692-Q1 support continuous LED status checks through the current monitor (IMON) output. The device also includes an open-drain fault indicator output that indicates LED overcurrent, output overvoltage, and output undervoltage conditions.

2.1 Typical Applications

This converter design describes an application of the TPS92692-Q1 device as a Boost and Boost-to-Battery LED driver with the specifications described in [Table 1](#). For applications with a different input voltage range or different output voltage range, refer to the TPS92692-Q1 data sheet ([SLVSDD9](#)).

2.2 Features

- Versatile LED driver capable of driving a string of 1 to 20 series-connected white LEDs
- Wide input voltage range of 4.5 V to 18 V
- Better than $\pm 4\%$ LED current regulation using a high-side current sense resistor
- Spread spectrum frequency modulation for improved EMI
- Internal analog voltage to PWM duty cycle generator for stand-alone dimming operation
- Supports Boost, Buck-Boost (Boost-to-Battery), SEPIC, and Flyback LED driver topologies

3 Connector Description

This section describes the connectors and test points on the EVM and how to properly connect, setup, and use the TPS92692EVM-880.

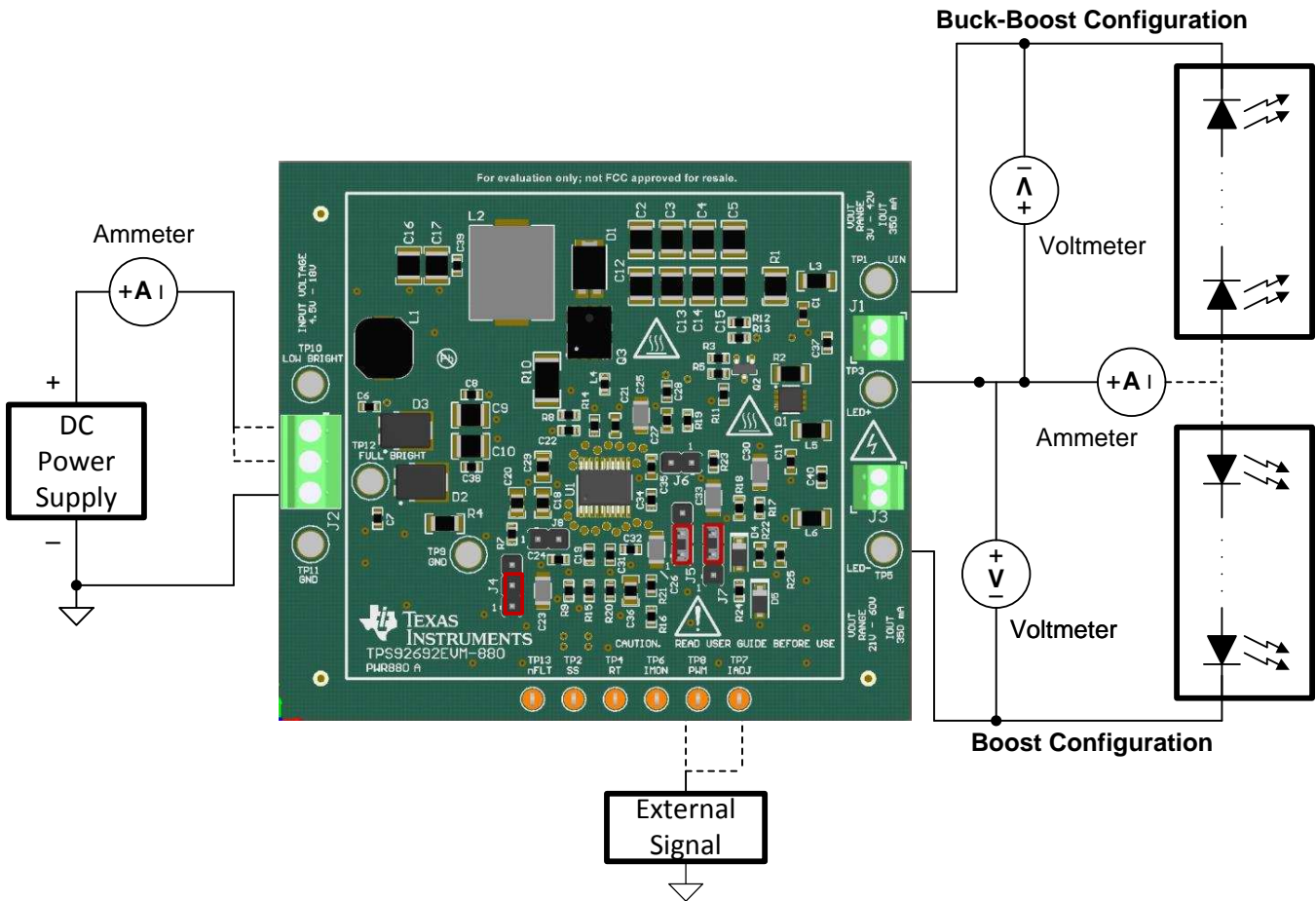

Figure 1. Connection Diagram

3.1 J2, Low Brightness, Full Brightness, GND

The 3-terminal screw-down connector, J2, is for connecting the EVM to the DC input voltage supply. To power the EVM, connect the positive terminal to pin 1 or pin 2 and the negative terminal to pin 3. The EVM can be configured to enter a low brightness state when power is applied to pin 1 and full brightness state when power is applied to pin 2. Other *Low Brightness* (TP10), *Full Brightness* (TP12), and *GND* (TP11) test points are provided on the board that can also be used for all purposes but input power.

3.2 Configuring for Boost or Boost-to-Battery (J1, J3)

The TPS92692EVM-880 can be configured as a boost regulator or a boost-to-battery regulator simply by connecting the LED load to either connector J1 or to connector J3 as described in this section. Do not attempt to use J1 and J3 simultaneously.

3.2.1 J1, LED+ , VIN (Boost-to-Battery)

The screw-down connector, J1, marked LED+ and VIN is for connecting the LED load to the board in the Boost-to-Battery (Buck-Boost) configuration. The positive terminal for the LED load connects to LED+ while the negative terminal connects to VIN. The Boost-to-Battery design is for approximately 1 to 11 white LEDs.

3.2.2 J3, LED+, GND (Boost)

The screw-down connector, J3, marked LED+ and LED- is for connecting the LED load to the board in the Boost configuration. The Boost design is for approximately 7 to 18 white LEDs.

3.3 J4, Fault Response Setting

The three-pin header marked J4 is used to select between fault indication mode and internal timer based hiccup mode. The default setting is a shunt placed between pins 1 and 2 of J4. This connects the $\overline{\text{FLT}}$ pin to the SS pin and enables hiccup mode operation under output short-circuit conditions. To enable fault indication mode, switch the shunt location to short pins 2 and 3 of J4. This connects the $\overline{\text{FLT}}$ pin to the VREF pin via a resistance and sets the active-low fault status flag under fault conditions.

3.4 J5, IADJ Input Select

The three-pin header marked J5 is used to select the method of setting the LED current using the IADJ pin of the device. The default setting is a shunt placed between pins 1 and 2 of J5. This sets the IADJ voltage using a resistor divider from VREF for a constant LED current. External control of the LED current set point can be achieved by placing the shunt between pins 2 and 3 of J5 and applying a DC or PWM signal to the IADJ test point, TP7. Direct analog dimming can be implemented by removing the shunt and applying voltage directly to pin 2 of J5.

3.5 PWM Dimming (J6, J7)

PWM dimming of LED current is achieved by directly modulating the DIM/PWM input pin with the desired duty cycle or by enabling the internal PWM generator circuit.

3.5.1 Dimming Using Internal Analog-to-PWM Conversion Circuit

The two-pin header marked J6, in conjunction with the three-pin header marked J7, is used to enable the internal analog-to-PWM conversion circuit. By default, the ramp generator is enabled by removing the shunt across pins 1 and 2 of J6. The three-pin header marked J7 can be used to set the DIM/PWM input voltage. In the default setting, a shunt is placed between pins 2 and 3 of J7. In this configuration, 100% duty cycle (full brightness) is achieved by connecting the input power supply to pin 2 of connector J2 and a fixed 8% duty cycle (low brightness) is achieved by connecting the input power supply to pin 1 of connector J2. External control of the LED current duty cycle can be achieved by placing the shunt between pins 1 and 2 of J7 and applying an analog signal to the PWM test point, TP8.

3.5.2 Direct PWM Dimming

Direct external PWM dimming mode is set by placing the shunt across pins 1 and 2 of J6. This connects a 249-k Ω resistor and results in a constant 2.49-V reference voltage. In this mode, it is necessary to connect the shunt across pins 1 and 2 of J7 and apply a 5-V external PWM signal to PWM test point, TP8. The PWM dimming frequency can be set between 100 Hz and 1 kHz. Do not leave PWM test point, TP8, floating when operating in this configuration.

3.6 J8, Dither Modulation Setting

The two-pin header marked J8 is used to enable or disable spread-spectrum frequency modulation (dither modulation). By default, dither modulation is enabled by not having the shunt across pins 1 and 2 of J8. This connects the external capacitor to the DM pin of the device. Placing the shunt across pins 1 and 2 shorts the DM pin to GND and disables dither modulation.

3.7 TP2, Soft Start

The test point SS connects through a 1-k Ω resistor to the SS pin of the TPS92692-Q1 device. The voltage range is from 0 V to 5 V, if driven externally. The SS voltage can be monitored with this test point. Pulling SS to GND will also serve to disable the part and put it into STANDBY mode.

3.8 TP8, PWM

The PWM test point connects through J7 to the DIM/PWM pin of the TPS92692-Q1 device. An analog voltage or PWM signal can be applied to set the LED current duty cycle based on the dimming configuration.

3.9 TP7, IADJ

The IADJ test point connects through a two-pole low-pass filter to the IADJ pin of the TPS92692-Q1 device. The default reference is set to 1.49 V through a resistor divider network connected to VREF, resulting in an output current of 356 mA. The voltage on IADJ can be externally set using either a pulse-width modulated signal from a function generator or a DC power supply between 140 mV to over 2.4 V. For more details on setting analog adjust voltage refer to [Section 6.5](#).

3.10 TP6, IMON

The IMON test point connects directly to the IMON pin of the TPS92692-Q1 device. The IMON voltage, corresponding to the measured LED current by the integrated rail-to-rail current sense amplifier, can be monitored with this test point. The pin can be connected to an external comparator or microcontroller to detect LED short-circuit, LED+ to VIN, and LED+ to GND fault conditions.

4 Boost LED Driver Electrical Performance Specifications

[Table 1](#) provides the EVM Boost configuration electrical performance specifications.

Table 1. TPS92692EVM-880 Boost Configuration Electrical Performance Specifications

Parameter	Test Conditions	MIN	TYP	MAX	Unit
Input Characteristics					
Input voltage range		7	14	18	V
Input UVLO setting			4.5		V
Maximum switch node voltage				100	V
Output Characteristics					
Output voltage, V_O	LED+ to LED-	21	40	60	V
LED current		100	350	500	mA
Maximum output power				25	W
Analog dimming range	$V_{IADJ} = 140 \text{ mV to } 2.1 \text{ V}$	15:1			
Internal RAMP generator frequency	Internal RAMP generator		240		Hz
Analog to PWM duty cycle set point (low brightness mode)			8		%
Analog to PWM duty cycle dimming range	$1 \leq V_{DIM} \leq 3$	4		100	%
Direct PWM dimming range	External PWM input signal, $100 \leq f_{PWM} \leq 1 \text{ kHz}$	1		100	%
Systems Characteristics					
Output overvoltage protection threshold			62		V
Output overvoltage protection hysteresis			3		V
Soft-start period			8		ms
Dither modulation frequency			600		Hz
Switching frequency			390		kHz

5 Boost LED Driver Schematic

Figure 2 illustrates the TPS92692EVM-880 schematic configured as a Boost LED driver.

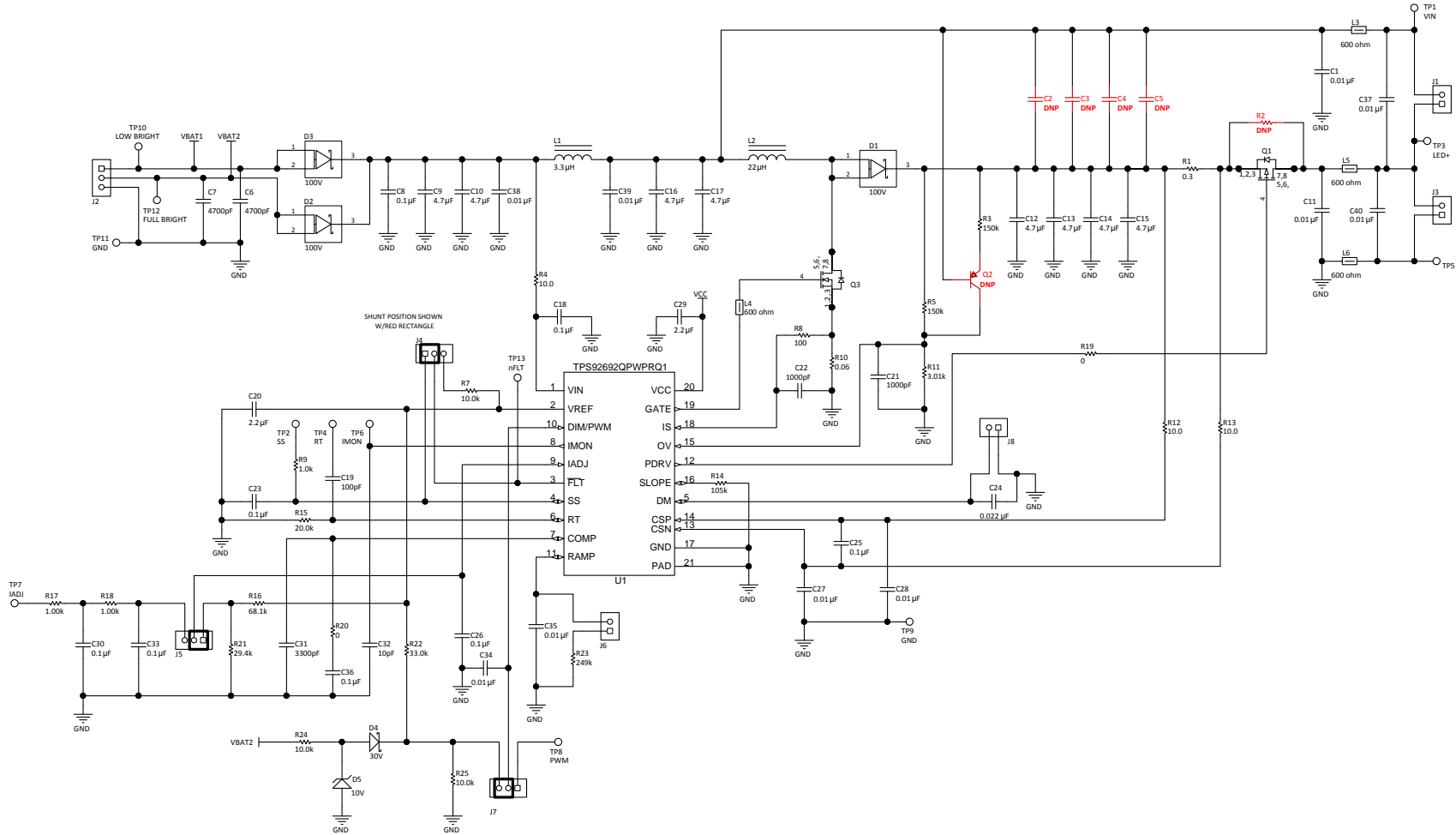

Figure 2. TPS92692EVM-880 Schematic: Configured as a Boost LED Driver

6 Performance Data and Typical Characteristic Curves

The following performance curves are presented for the EVM configured as a Boost LED driver (Figure 2).

6.1 Efficiency

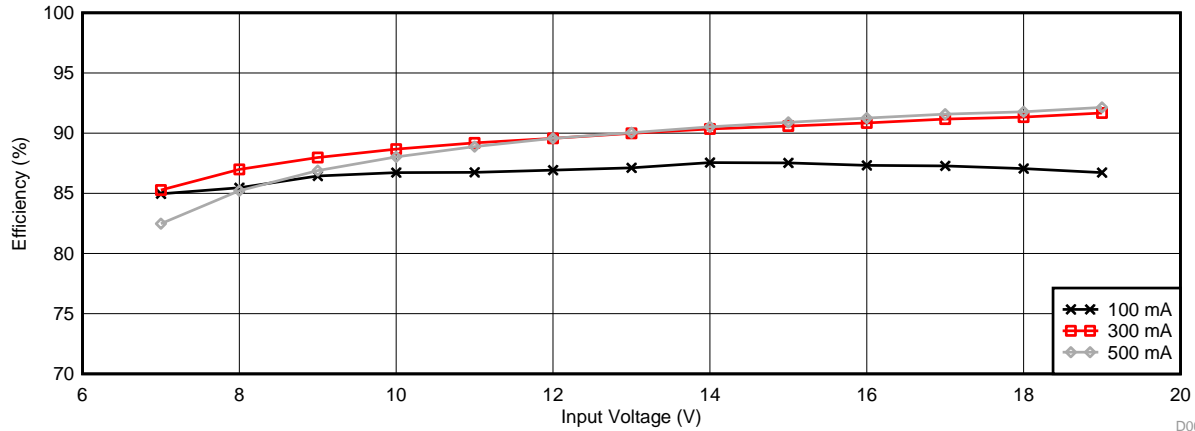

Figure 3. Efficiency vs Input Voltage (Number of Series-Connected LEDs = 8)

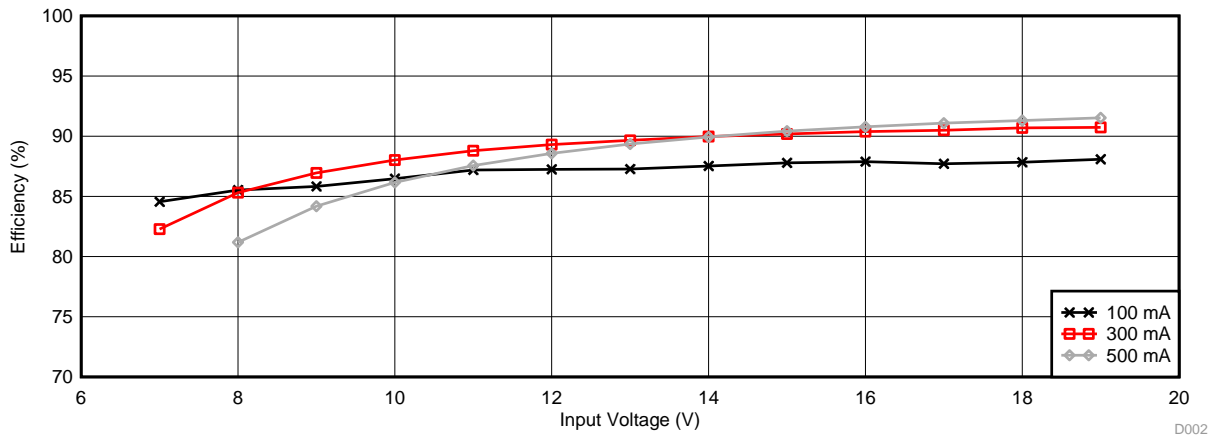

Figure 4. Efficiency vs Input Voltage (Number of Series-Connected LEDs = 13)

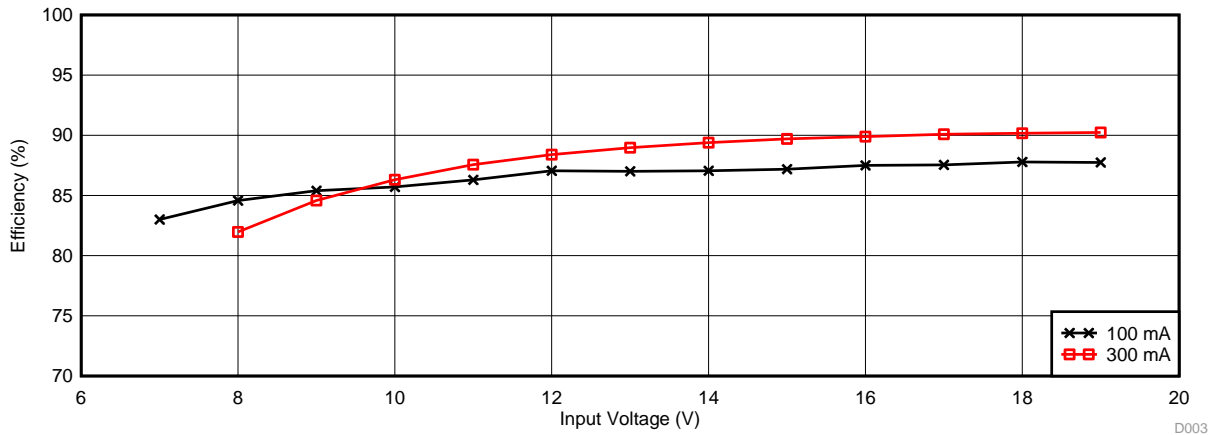

Figure 5. Efficiency vs Input Voltage (Number of Series-Connected LEDs = 18)

6.2 Line Regulation

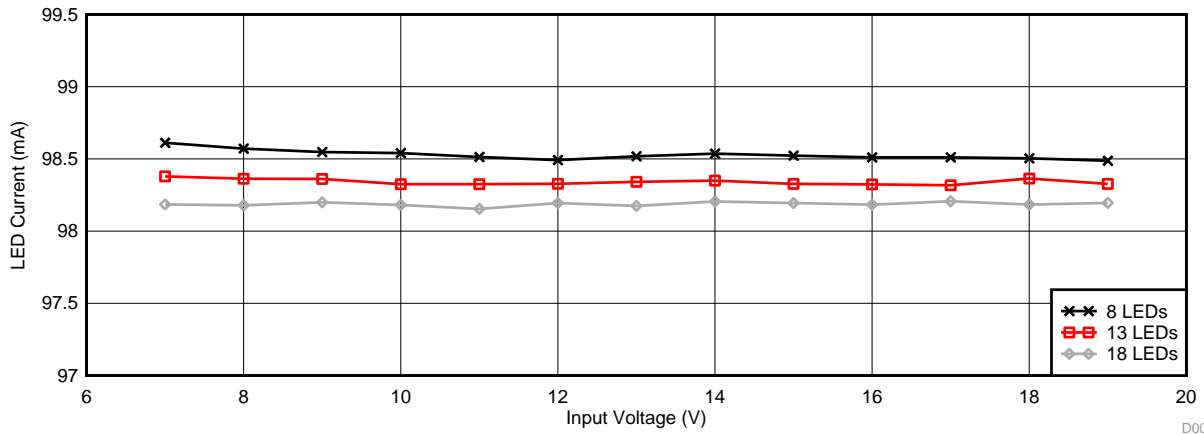

Figure 6. Output LED Current vs Input Voltage ($V_{IADJ} = 420 \text{ mV}$)

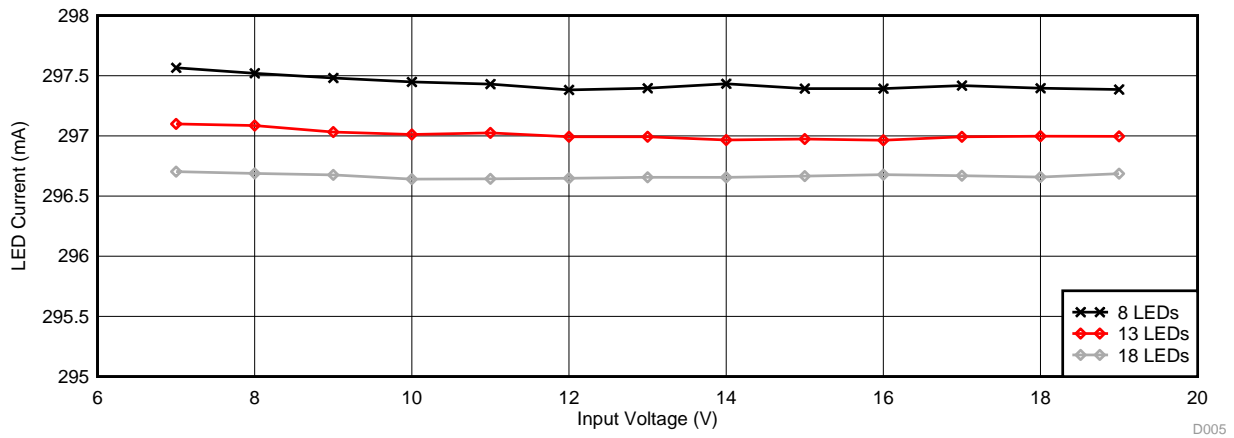

Figure 7. Output LED Current vs Input Voltage ($V_{IADJ} = 1.26 \text{ V}$)

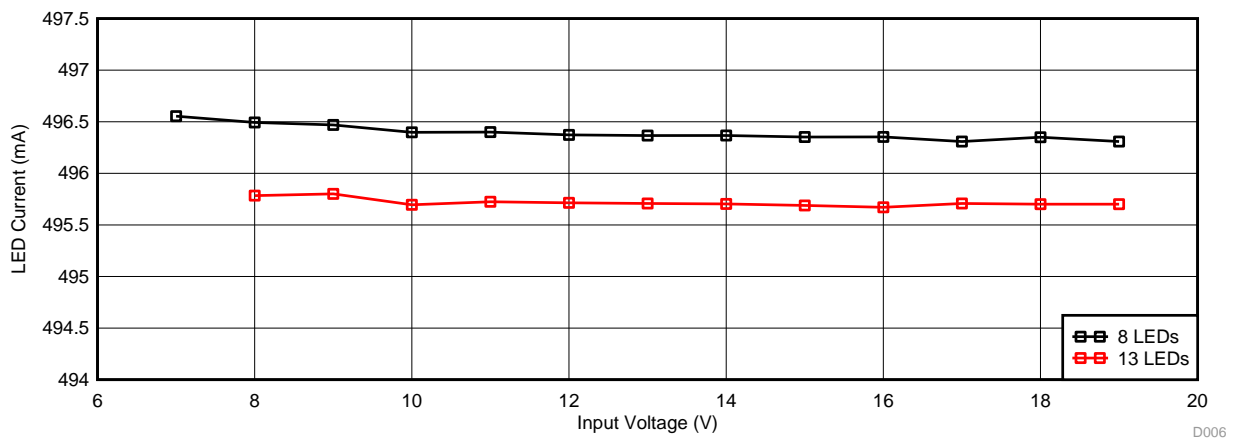

Figure 8. Output LED Current vs Input Voltage ($V_{IADJ} = 2.1 \text{ V}$)

6.3 Load Regulation

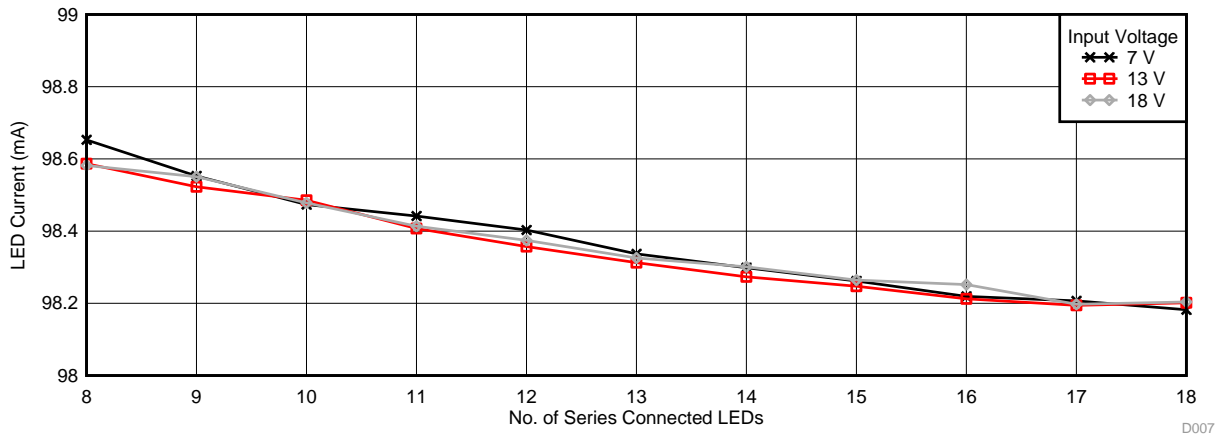

Figure 9. Output LED Current vs LED String Configuration ($V_{IADJ} = 420 \text{ mV}$)

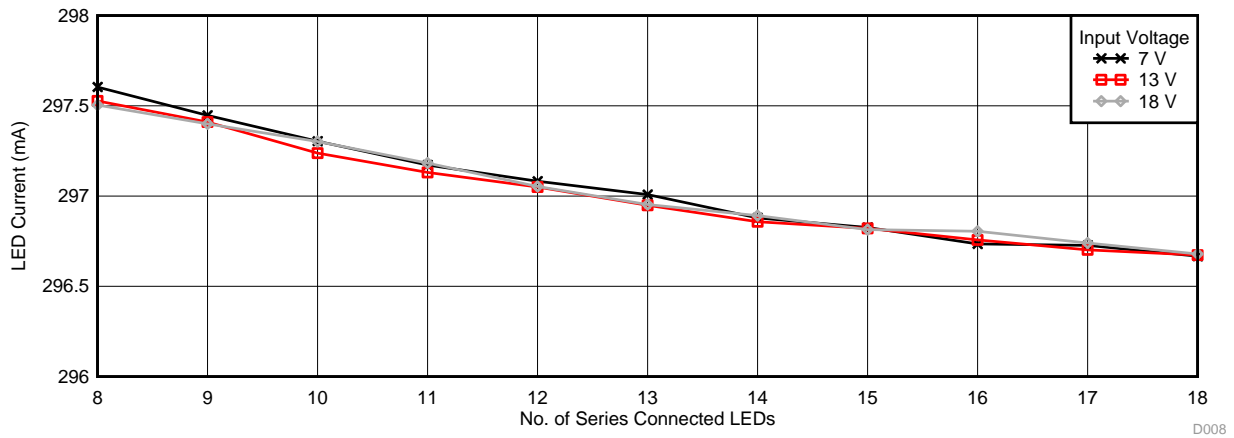

Figure 10. Output LED Current vs LED String Configuration ($V_{IADJ} = 1.26 \text{ V}$)

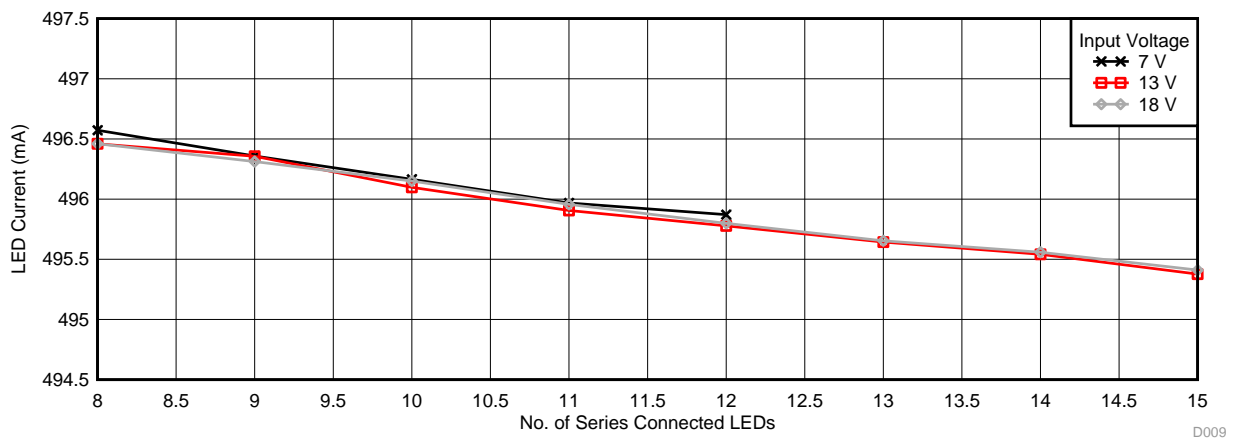

Figure 11. Output LED Current vs LED String Configuration ($V_{IADJ} = 2.1 \text{ V}$)

6.4 Temperature Characteristics

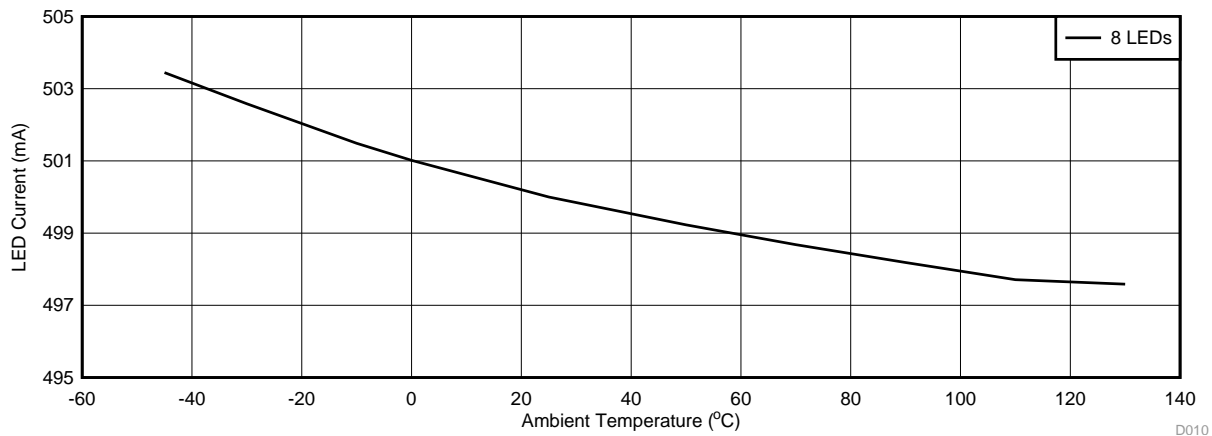

Figure 12. LED Current vs Ambient Temperature ($V_{IN} = 13\text{ V}$, Number of LEDs in Series = 8)

6.5 Analog Adjust Settings

The EVM is configured with the IADJ voltage, V_{IADJ} , set to 1.49 V using resistor divider network, R16 and R21 between VREF and GND. The resulting LED current is 356 mA for a current sense resistor, $R_{CS} = R1$, of 300 m Ω . Calculation is based on:

$$I_{LED} = \frac{V_{IADJ}}{14} \frac{1}{R_{CS}}$$

The desired LED current can be achieved by setting the corresponding voltage, V_{IADJ} , and reconfiguring the resistor divider network, R16 and R21. The internal reference clamp of 2.4 V can be activated by depopulating resistor R21 and connecting IADJ to VREF through pullup resistor R16.

External control via the IADJ test point, TP7, can be enabled by changing the shunt position to connect pins 2 and 3 of J5. The IADJ voltage and hence the LED current can be modulated over the entire operating range by connecting a DC power supply or a function generator across TP7 to GND. To ensure proper operation and limit temperature rise, the maximum output power should be limited to 25 W for any given LED stack voltage and LED current combination.

6.6 Analog-to-PWM Dimming

The EVM can be configured for Analog-to-PWM dimming operation by removing the shunt across J6, which connects the capacitor from the RAMP pin to GND. The EVM can be configured to operate with a fixed-duty cycle of 8% by connecting a shunt across pins 2 and 3 of J7. In this case the V_{DIM} voltage is set by the resistor divider, R22 and R25, between VREF and GND. The low-brightness mode is activated when the input power is applied across pins 1 and 3 of J2.

External control, via the PWM test point, TP8, can be enabled by changing the shunt position to connect pins 1 and 2 of J7. The DIM/PWM voltage and hence the LED current duty cycle is modulated based on the voltage supplied by the external DC power supply.

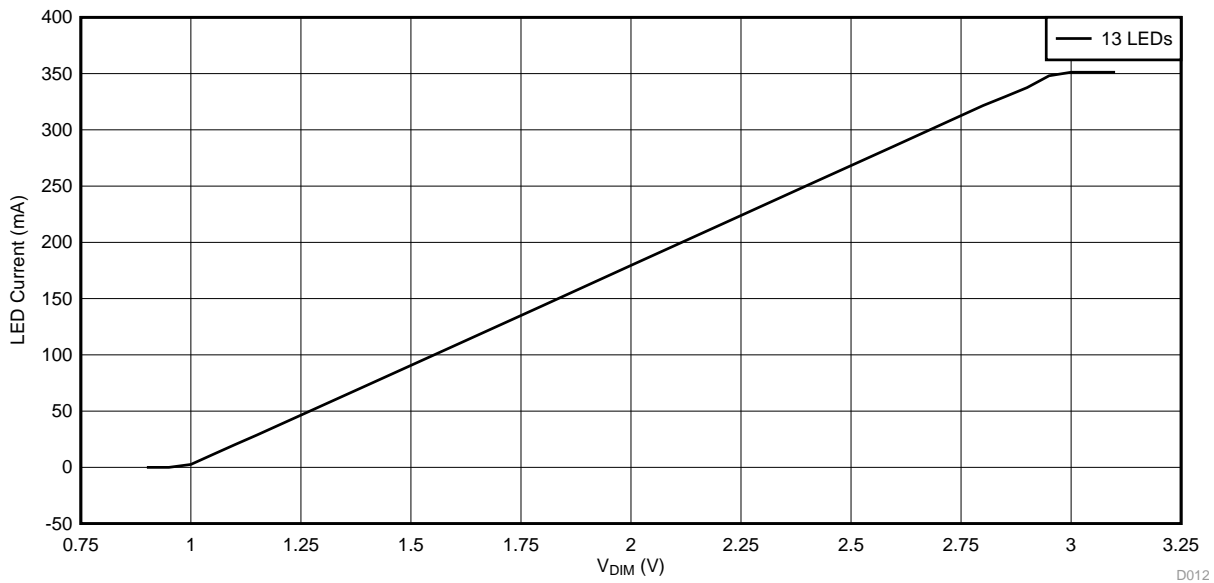
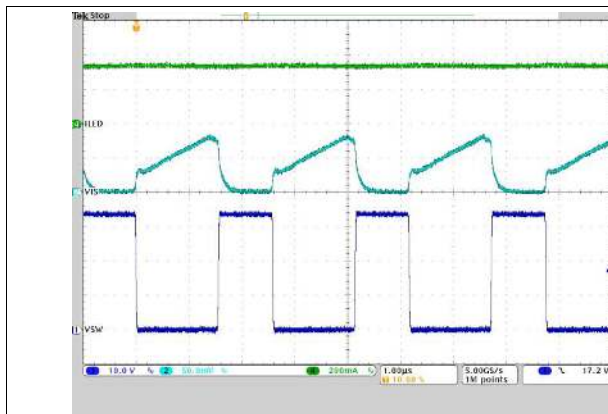

Figure 13. LED Current vs DIM/PWM Voltage ($V_{IADJ} = 1.49$ V, Number of LEDs in Series = 13)

6.7 Direct External PWM Dimming

The EVM can be configured for direct PWM dimming based on an external signal by changing the shunt position and shorting pins 1 and 2 of J6 and pins 1 and 2 of J7. An external function generator can be connected to PWM test point, TP8 and the LED current can be directly modulated based on the duty cycle of external PWM signal.

6.8 Typical Waveforms



Ch1: Switch node voltage
Ch2: Switch current sense voltage
Ch4: LED current; Time: 1 μ s/div

Figure 14. Normal Operation

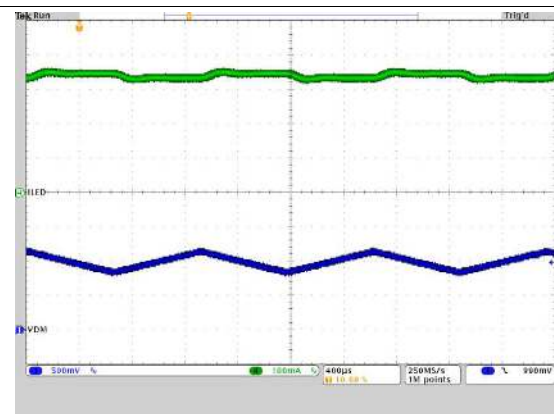

Ch1: Dither modulation voltage
Ch4: LED current; Time: 400 μ s/div

Figure 15. Spread Spectrum Frequency Modulation

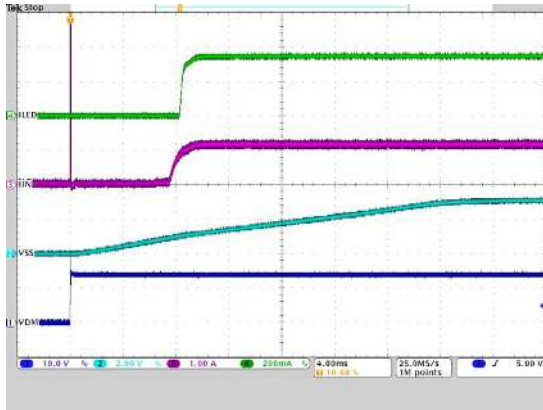

Ch1: Input voltage; Ch2: Soft-start (SS) voltage
Ch3: Input current
Ch4: LED current; Time: 4 ms/div
Figure 16. Startup Transient

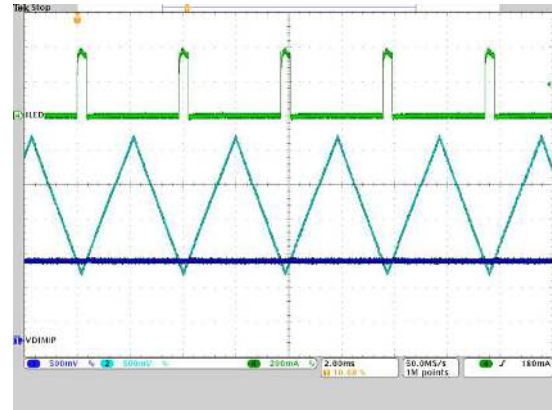

Ch1: Dim/PWM voltage
Ch2: RAMP pin voltage
Ch4: LED current; Time: 2 ms/div
Figure 17. Analog-to-PWM Dimming Transient

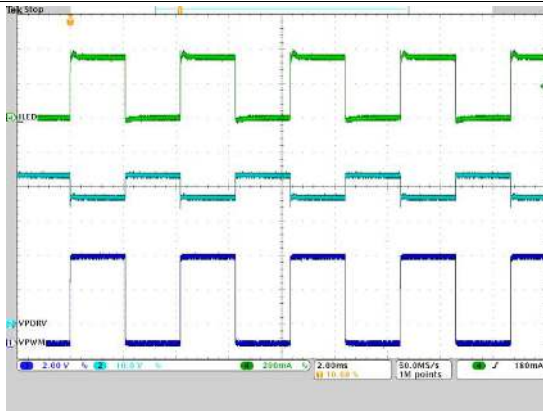

Ch1: External PWM input signal
Ch2: PDRV voltage
Ch4: LED current; Time: 2 ms/div
Figure 18. Direct PWM Dimming Transient

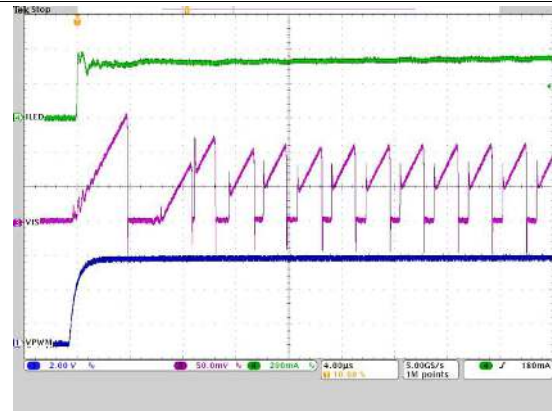

Ch1: External PWM input voltage
Ch3: Switch sense current resistor voltage
Ch4: LED current; Time: 4 µs/div
Figure 19. PWM Dimming Transient (Zoomed)

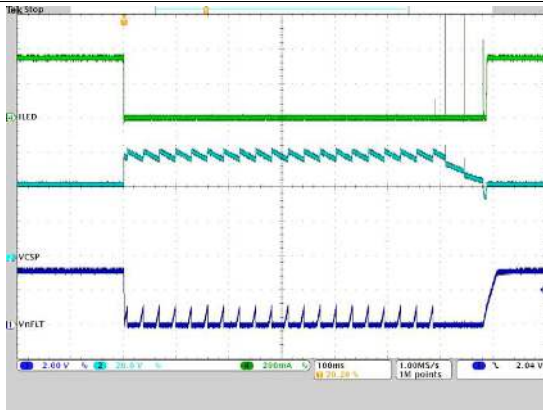

Ch1: FLT output
Ch2: GSP pin voltage
Ch4: LED current; Time: 100 ms/div
Figure 20. LED Open-Circuit Fault

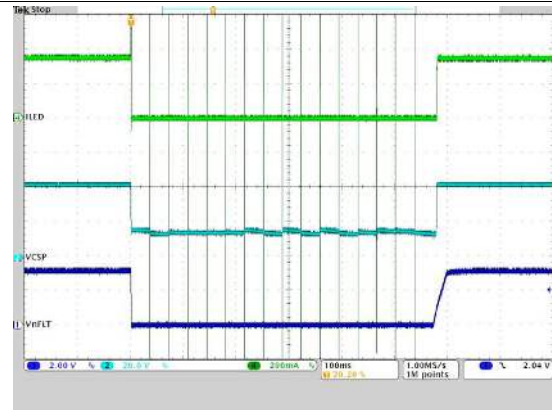

Ch1: FLT output
Ch2: GSP pin voltage
Ch4: LED current; Time: 100 ms/div
Figure 21. LED Short-Circuit Fault

6.9 EMI

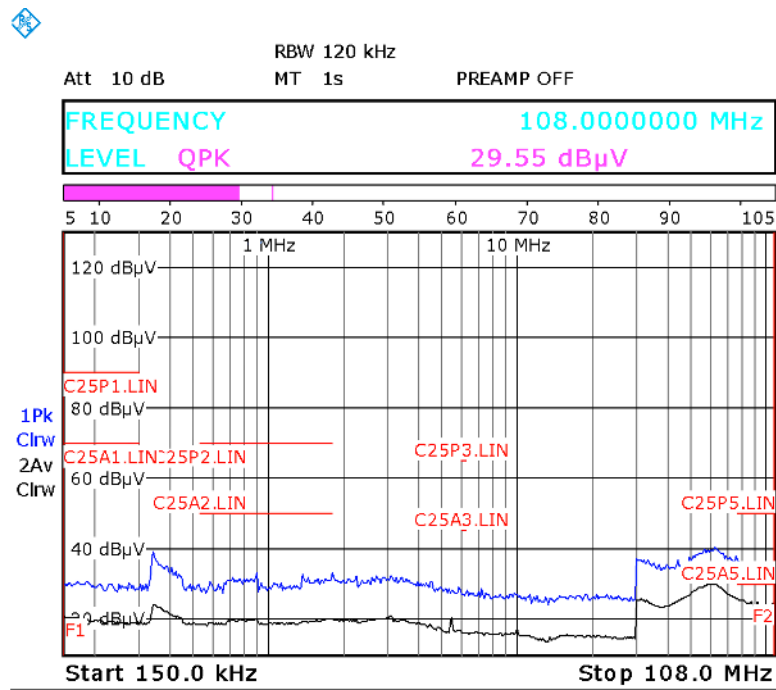

Figure 22. Conducted EMI Based on CISPR 25 Class 3 Limits (Dither Modulation Enabled)

7 Buck-Boost LED Driver Electrical Performance Specifications

Table 2 provides the EVM Buck-Boost configuration electrical performance specifications.

Table 2. TPS92692EVM-880 Buck-Boost Configuration Electrical Performance Specifications

Parameter	Test Conditions	MIN	TYP	MAX	Unit
Input Characteristics					
Input voltage range		7	14	18	V
Input UVLO setting			4.5		V
Maximum switch node voltage				100	V
Output Characteristics					
Output voltage, V_O	LED+ to VIN	3	21	39.6	V
LED current		100	350	500	mA
Maximum output power				20	W
Analog dimming range	$V_{IADJ} = 140 \text{ mV to } 2.1 \text{ V}$	15:1			
Internal RAMP generator frequency	Internal RAMP generator		240		Hz
Analog to PWM duty cycle set point (low brightness mode)			8		%
Analog to PWM duty cycle dimming range	$1 \leq V_{DIM} \leq 3$	4		100	%
Direct PWM dimming range	External PWM input signal, $100 \leq f_{PWM} \leq 1 \text{ kHz}$	1		100	%
Systems Characteristics					
Output overvoltage protection threshold			44		V
Output overvoltage protection hysteresis			3		V
Soft-start period			8		ms
Dither modulation frequency			600		Hz
Switching frequency			390		kHz

8 Buck-Boost LED Driver Schematic

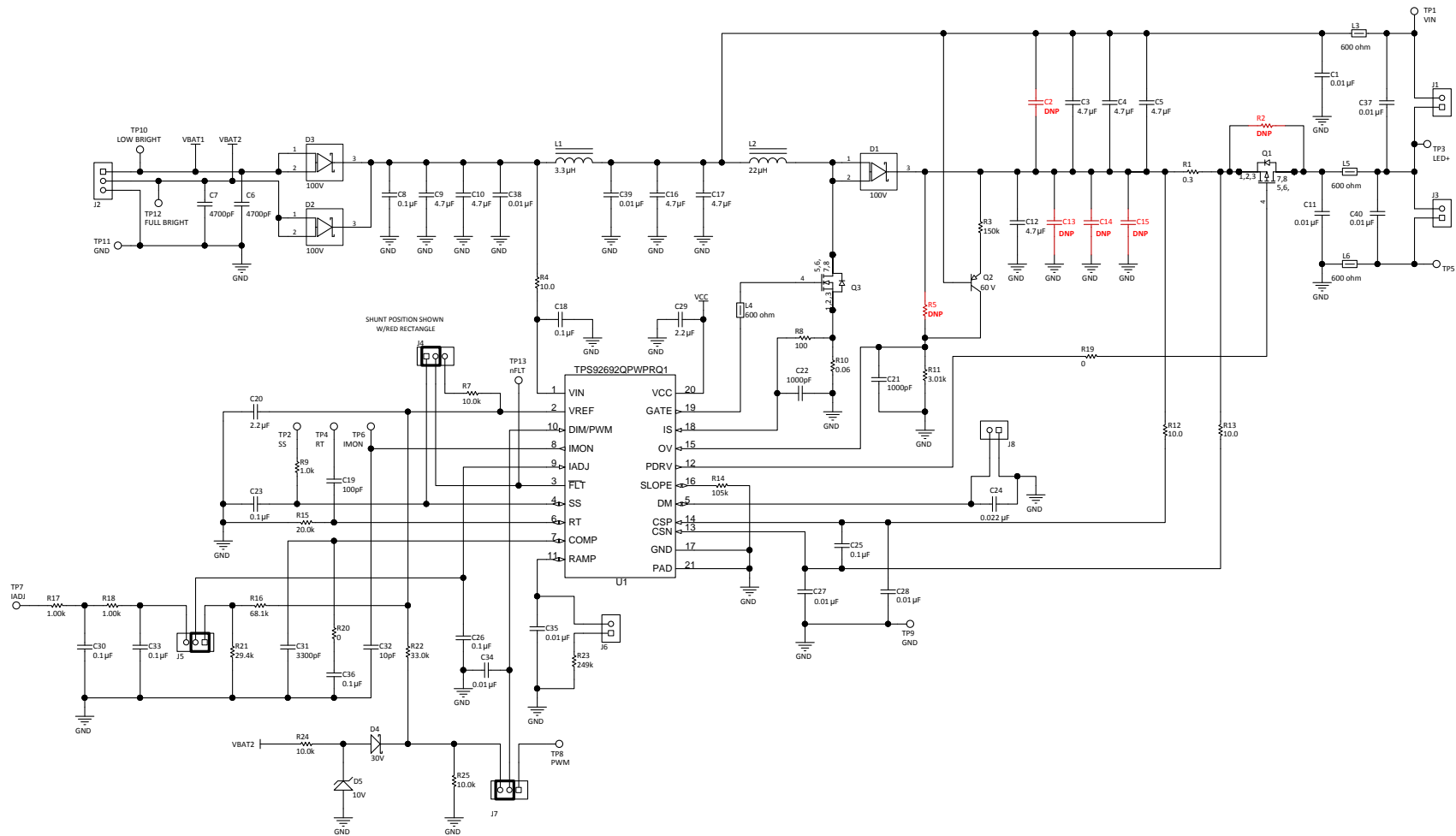

Figure 23. TPS92692EV-880 Schematic: Configured as a Buck-Boost LED Driver

9 Performance Data and Typical Characteristic Curves

The following performance curves are presented for the EVM configured as a Buck-Boost LED driver (Figure 23).

9.1 Efficiency

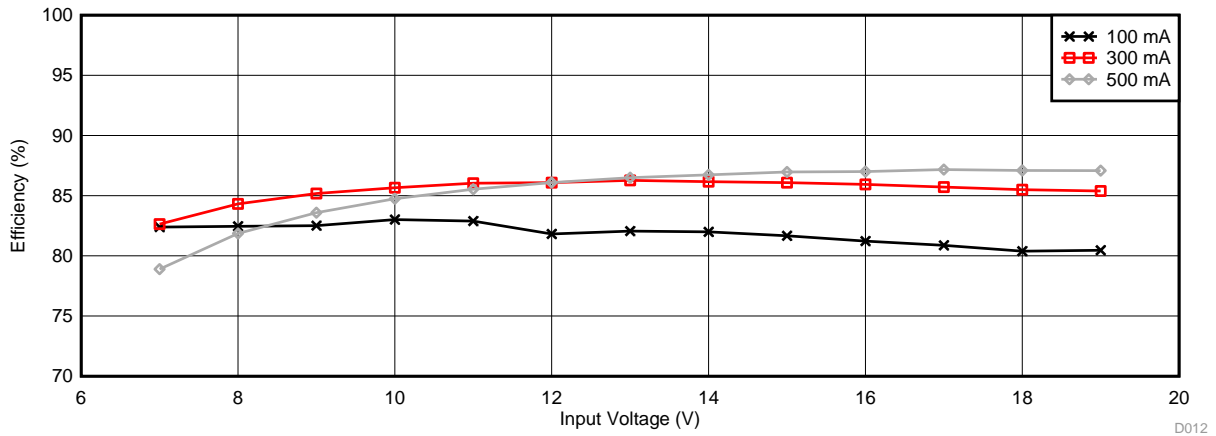

Figure 24. Efficiency vs Input Voltage (Number of Series-Connected LEDs = 7)

9.2 Line Regulation

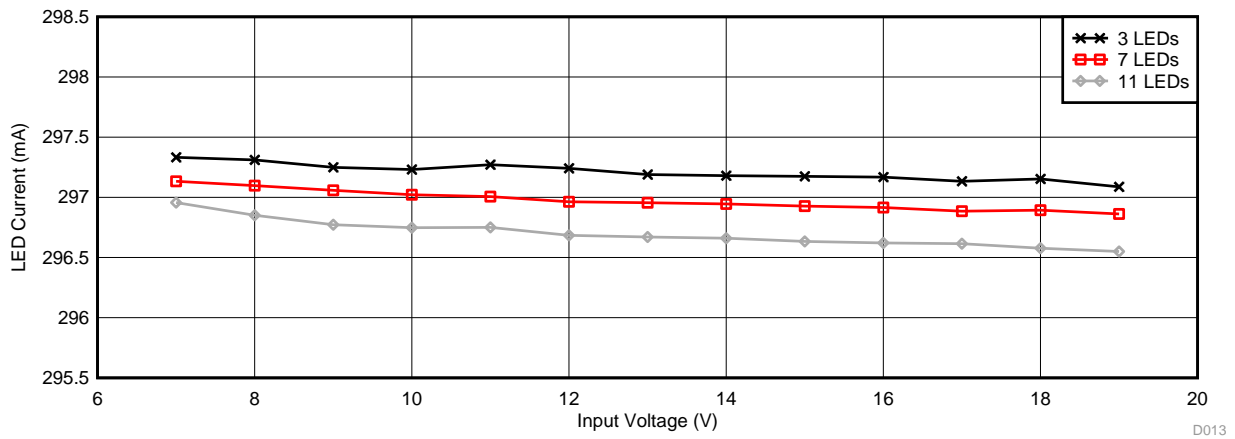

Figure 25. Output LED Current vs Input Voltage ($V_{IADJ} = 1.26$ V)

9.3 Load Regulation

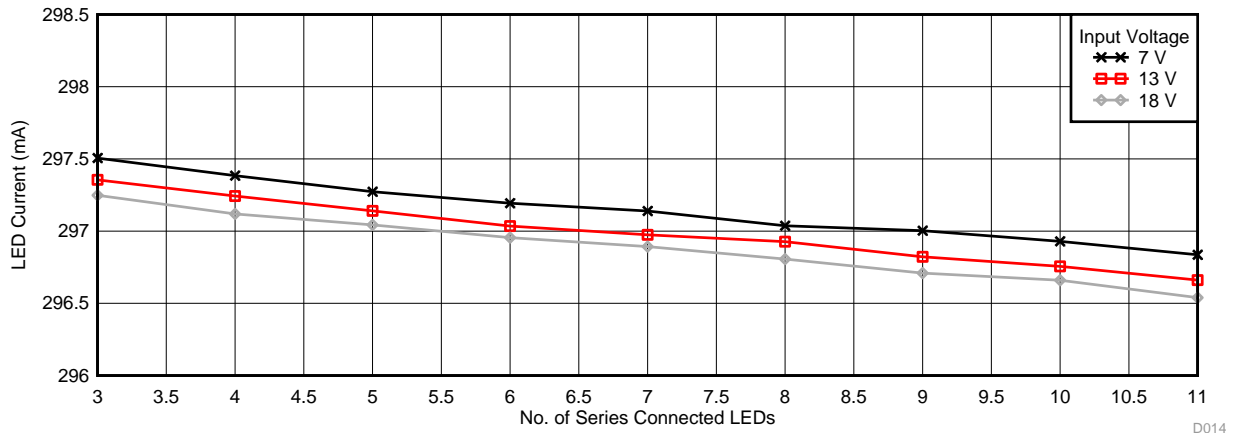
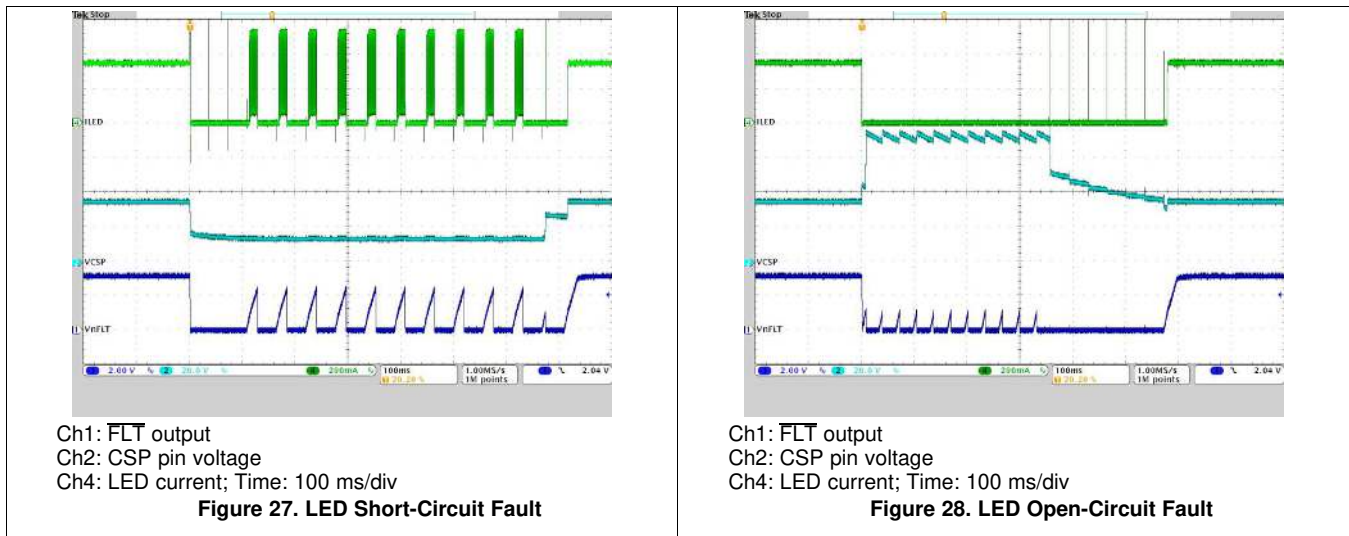

Figure 26. Output LED Current vs LED String Configuration ($V_{IADJ} = 1.26\text{ V}$)

9.4 Typical Waveforms



10 TPS92692EVM-880 Assembly Drawing and PCB layout

Figure 29, Figure 30, and Figure 31 show the design and assembly of the TPS92692EVM-880 printed-circuit board.

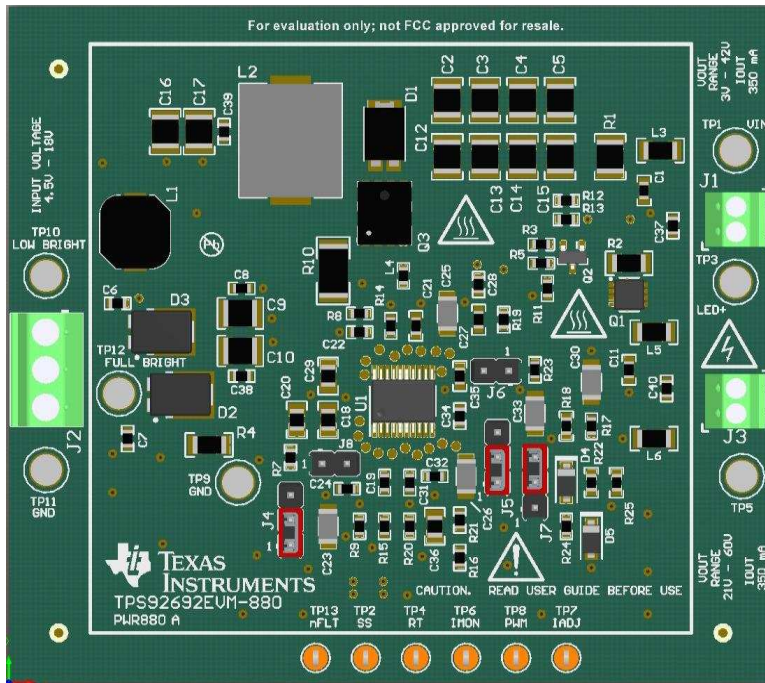

Figure 29. Assembly Drawing

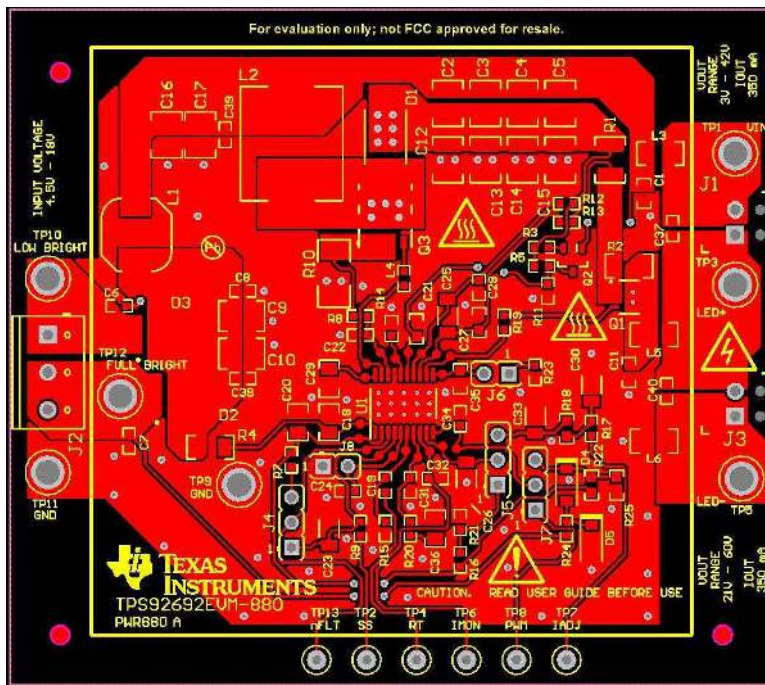

Figure 30. Top Layer and Top Overlay (Top View)

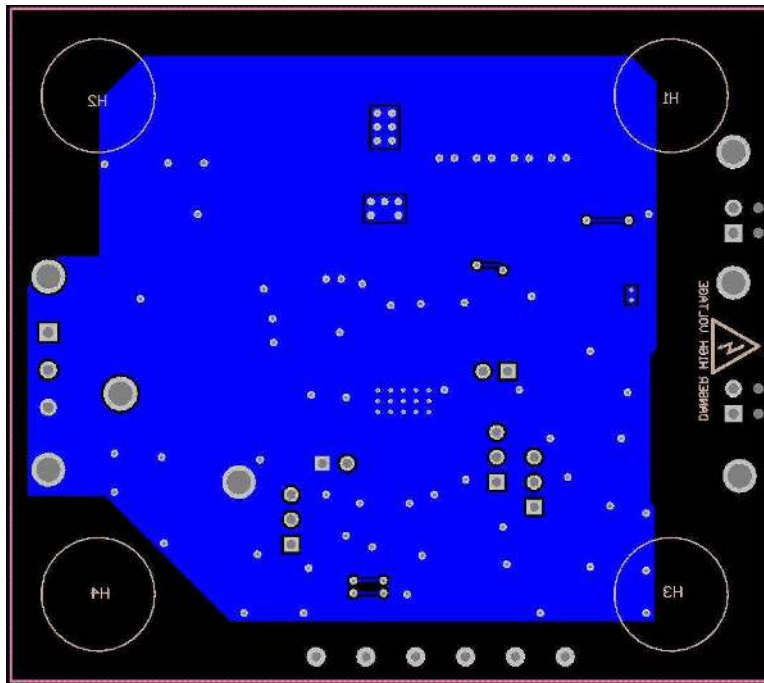

Figure 31. Bottom Layer and Bottom Overlay (Bottom View)

11 Bill of Materials

Table 3 lists the TPS92692EVM-880 components for Boost configuration according to the schematic shown in Figure 2.

Table 3. Bill of Materials

Designator	Qty	Value	Description	Package	Part Number	Manufacturer
U1	1		High Accuracy LED Controller With Spread Spectrum Frequency Modulation	PWP0020M	TPS92692QPWPRQ1	Texas Instruments
C1, C11, C34, C35, C37, C38, C39, C40	8	0.01uF	CAP, CERM, 0.01 μF, 100 V, ±10%, X7R, AEC-Q200 Grade 1, 0603	0603	CGA3E2X7R2A103K080AA	TDK
C6, C7	2	4700pF	CAP, CERM, 4700 pF, 100 V, ±10%, X7R, AEC-Q200 Grade 1, 0603	0603	CGA3E2X7R2A472K080AA	TDK
C8	1	0.1uF	CAP, CERM, 0.1 μF, 50 V, ±10%, X7R, AEC-Q200 Grade 1, 0603	0603	CGA3E2X7R1H104K080AA	TDK
C9, C10, C12, C13, C14, C15, C16, C17	8	4.7uF	CAP, CERM, 4.7 μF, 100 V, ±10%, X7S, AEC-Q200 Grade 1, 1210	1210	CGA6M3X7S2A475K200AB	TDK
C18	1	0.1uF	CAP, CERM, 0.1 μF, 100 V, ±10%, X7R, 0805	0805	C2012X7R2A104K125AA	TDK
C19	1	100pF	CAP, CERM, 100 pF, 100 V, ±1%, C0G/NP0, 0603	0603	C1608C0G2A101F080AA	TDK
C20, C29	2	2.2uF	CAP, CERM, 2.2 μF, 25 V, ±10%, X7R, AEC-Q200 Grade 1, 0805	0805	CGA4J3X7R1E225K125AB	TDK
C21, C22	2	1000pF	CAP, CERM, 1000 pF, 100 V, ±10%, X7R, AEC-Q200 Grade 1, 0603	0603	CGA3E2X7R2A102K080AA	TDK
C23, C25, C26, C30, C33	5	0.1uF	CAP, CERM, 0.1 μF, 100 V, ±10%, X7R, AEC-Q200 Grade 1, 1206	1206	CGA5L2X7R2A104K160AA	TDK
C24	1	0.022uF	CAP, CERM, 0.022 μF, 100 V, ±10%, X7R, AEC-Q200 Grade 1, 0603	0603	CGA3E2X7R2A223K080AA	TDK
C31	1	3300pF	CAP, CERM, 3300 pF, 50 V, ±10%, X7R, 0603	0603	GRM188R71H332KA01D	Murata
C32	1	10pF	CAP, CERM, 10 pF, 50 V, ±5%, C0G/NP0, AEC-Q200 Grade 1, 0603	0603	CGA3E2C0G1H100D080AA	TDK
C36	1	0.1uF	CAP, CERM, 0.1 μF, 50 V, ±10%, X7R, AEC-Q200 Grade 1, 0805	0805	CEU4J2X7R1H104K125AE	TDK
D1	1	100V	Diode, Schottky, 100 V, 3 A, AEC-Q101, PowerDI5	PowerDI5	PDS3100Q-13	Diodes Inc.
D2, D3	2	100V	Diode, Schottky, 100 V, 12 A, AEC-Q101, TO-277A	TO-277A	V12P10-M3/86A	Vishay-Semiconductor
D4	1	30V	Diode, Schottky, 30 V, 0.2 A, SOD-123	SOD-123	BAT42W-7-F	Diodes Inc.
D5	1	10V	Diode, Zener, 10 V, 500 mW, SOD-123	SOD-123	MMSZ5240B-7-F	Diodes Inc.
J1, J3	2		Terminal Block, 100mil, 2x1, 6A, 63V, TH	6.2x8.5x5.54 mm	1725656	Phoenix Contact
J2	1		Terminal Block Receptacle, 3x1, 3.81mm, R/A, TH	Term Block, 3 pos	1727023	Phoenix Contact
J4, J5, J7	3		Header, 2.54mm, 3x1, Tin, TH	3x1, TH	0022284033	Molex
J6, J8	2		Header, 2.54mm, 2x1, Tin, TH	2x1, TH	0022284023	Molex
L1	1	3.3uH	Inductor, Shielded, Ferrite, 3.3 μH, 5 A, 0.0213 ohm, SMD	6.2x4.5x5.9mm	CLF7045T-3R3N	TDK
L2	1	22uH	Inductor, Shielded Drum Core, Powdered Iron, 22 μH, 4.1 A, 0.0705 ohm, AEC-Q200 Grade 0, SMD	IHLP-4040DZ	IHLP4040DZER220M8A	Vishay-Dale
L3, L5, L6	3	600 ohm	Ferrite Bead, 600 ohm @ 100 MHz, 1.5 A, 1206	1206	MI1206K601R-10	Laird-Signal Integrity Products
L4	1	600 ohm	Ferrite Bead, 600 ohm @ 100 MHz, 1.3 A, 0603	0603	BLM18KG601SN1D	Murata

Table 3. Bill of Materials (continued)

Designator	Qty	Value	Description	Package	Part Number	Manufacturer
Q1	1	-60V	MOSFET, P-CH, -60 V, -3.6 A, PowerPAK 1212	PowerPAK 1212	SI7415DN-T1-GE3	Vishay-Siliconix
Q3	1	100V	MOSFET, N-CH, 100 V, 20 A, AEC-Q101, 8-PowerVDFN	8-PowerVDFN	STL8N10LF3	STMicroelectronics
R1	1	0.3	RES, 0.3, 1%, 0.5 W, 1210	1210	MCR25JZHFLR300	Rohm
R3, R5	2	150k	RES, 150 k, 1%, 0.1 W, 0603	0603	CRCW0603150KFKEA	Vishay-Dale
R4	1	10.0	RES, 10.0, 1%, 0.25 W, 1206	1206	CRCW120610R0FKEA	Vishay-Dale
R7, R24, R25	3	10.0k	RES, 10.0 k, 1%, 0.1 W, 0603	0603	CRCW060310K0FKEA	Vishay-Dale
R8	1	100	RES, 100, 1%, 0.1 W, 0603	0603	CRCW0603100RFKEA	Vishay-Dale
R9	1	1.0k	RES, 1.0 k, 5%, 0.1 W, 0603	0603	CRCW06031K00JNEA	Vishay-Dale
R10	1	0.06	RES, 0.06, 1%, 1 W, 2010	2010	CSRN2010FK60L0	Stackpole Electronics Inc
R11	1	3.01k	RES, 3.01 k, 1%, 0.1 W, 0603	0603	CRCW06033K01FKEA	Vishay-Dale
R12, R13	2	10.0	RES, 10.0, 1%, 0.1 W, 0603	0603	CRCW060310R0FKEA	Vishay-Dale
R14	1	105k	RES, 105 k, 1%, 0.1 W, 0603	0603	CRCW0603105KFKEA	Vishay-Dale
R15	1	20.0k	RES, 20.0 k, 1%, 0.1 W, 0603	0603	CRCW060320K0FKEA	Vishay-Dale
R16	1	68.1k	RES, 68.1 k, 1%, 0.1 W, 0603	0603	CRCW060368K1FKEA	Vishay-Dale
R17, R18	2	1.00k	RES, 1.00 k, 1%, 0.1 W, 0603	0603	CRCW06031K00FKEA	Vishay-Dale
R19, R20	2	0	RES, 0, 5%, 0.1 W, 0603	0603	CRCW06030000Z0EA	Vishay-Dale
R21	1	29.4k	RES, 29.4 k, 1%, 0.1 W, 0603	0603	CRCW060329K4FKEA	Vishay-Dale
R22	1	33.0k	RES, 33.0 k, 1%, 0.1 W, 0603	0603	CRCW060333K0FKEA	Vishay-Dale
R23	1	249k	RES, 249 k, 1%, 0.1 W, 0603	0603	CRCW0603249KFKEA	Vishay-Dale

STANDARD TERMS FOR EVALUATION MODULES

1. *Delivery:* TI delivers TI evaluation boards, kits, or modules, including any accompanying demonstration software, components, and/or documentation which may be provided together or separately (collectively, an "EVM" or "EVMs") to the User ("User") in accordance with the terms set forth herein. User's acceptance of the EVM is expressly subject to the following terms.
 - 1.1 EVMs are intended solely for product or software developers for use in a research and development setting to facilitate feasibility evaluation, experimentation, or scientific analysis of TI semiconductor products. EVMs have no direct function and are not finished products. EVMs shall not be directly or indirectly assembled as a part or subassembly in any finished product. For clarification, any software or software tools provided with the EVM ("Software") shall not be subject to the terms and conditions set forth herein but rather shall be subject to the applicable terms that accompany such Software
 - 1.2 EVMs are not intended for consumer or household use. EVMs may not be sold, sublicensed, leased, rented, loaned, assigned, or otherwise distributed for commercial purposes by Users, in whole or in part, or used in any finished product or production system.
2. *Limited Warranty and Related Remedies/Disclaimers:*
 - 2.1 These terms do not apply to Software. The warranty, if any, for Software is covered in the applicable Software License Agreement.
 - 2.2 TI warrants that the TI EVM will conform to TI's published specifications for ninety (90) days after the date TI delivers such EVM to User. Notwithstanding the foregoing, TI shall not be liable for a nonconforming EVM if (a) the nonconformity was caused by neglect, misuse or mistreatment by an entity other than TI, including improper installation or testing, or for any EVMs that have been altered or modified in any way by an entity other than TI, (b) the nonconformity resulted from User's design, specifications or instructions for such EVMs or improper system design, or (c) User has not paid on time. Testing and other quality control techniques are used to the extent TI deems necessary. TI does not test all parameters of each EVM. User's claims against TI under this Section 2 are void if User fails to notify TI of any apparent defects in the EVMs within ten (10) business days after delivery, or of any hidden defects with ten (10) business days after the defect has been detected.
 - 2.3 TI's sole liability shall be at its option to repair or replace EVMs that fail to conform to the warranty set forth above, or credit User's account for such EVM. TI's liability under this warranty shall be limited to EVMs that are returned during the warranty period to the address designated by TI and that are determined by TI not to conform to such warranty. If TI elects to repair or replace such EVM, TI shall have a reasonable time to repair such EVM or provide replacements. Repaired EVMs shall be warranted for the remainder of the original warranty period. Replaced EVMs shall be warranted for a new full ninety (90) day warranty period.
3. *Regulatory Notices:*
 - 3.1 *United States*
 - 3.1.1 *Notice applicable to EVMs not FCC-Approved:*

FCC NOTICE: This kit is designed to allow product developers to evaluate electronic components, circuitry, or software associated with the kit to determine whether to incorporate such items in a finished product and software developers to write software applications for use with the end product. This kit is not a finished product and when assembled may not be resold or otherwise marketed unless all required FCC equipment authorizations are first obtained. Operation is subject to the condition that this product not cause harmful interference to licensed radio stations and that this product accept harmful interference. Unless the assembled kit is designed to operate under part 15, part 18 or part 95 of this chapter, the operator of the kit must operate under the authority of an FCC license holder or must secure an experimental authorization under part 5 of this chapter.
 - 3.1.2 *For EVMs annotated as FCC – FEDERAL COMMUNICATIONS COMMISSION Part 15 Compliant:*

CAUTION

This device complies with part 15 of the FCC Rules. Operation is subject to the following two conditions: (1) This device may not cause harmful interference, and (2) this device must accept any interference received, including interference that may cause undesired operation.

Changes or modifications not expressly approved by the party responsible for compliance could void the user's authority to operate the equipment.

FCC Interference Statement for Class A EVM devices

NOTE: This equipment has been tested and found to comply with the limits for a Class A digital device, pursuant to part 15 of the FCC Rules. These limits are designed to provide reasonable protection against harmful interference when the equipment is operated in a commercial environment. This equipment generates, uses, and can radiate radio frequency energy and, if not installed and used in accordance with the instruction manual, may cause harmful interference to radio communications. Operation of this equipment in a residential area is likely to cause harmful interference in which case the user will be required to correct the interference at his own expense.

FCC Interference Statement for Class B EVM devices

NOTE: This equipment has been tested and found to comply with the limits for a Class B digital device, pursuant to part 15 of the FCC Rules. These limits are designed to provide reasonable protection against harmful interference in a residential installation. This equipment generates, uses and can radiate radio frequency energy and, if not installed and used in accordance with the instructions, may cause harmful interference to radio communications. However, there is no guarantee that interference will not occur in a particular installation. If this equipment does cause harmful interference to radio or television reception, which can be determined by turning the equipment off and on, the user is encouraged to try to correct the interference by one or more of the following measures:

- Reorient or relocate the receiving antenna.
- Increase the separation between the equipment and receiver.
- Connect the equipment into an outlet on a circuit different from that to which the receiver is connected.
- Consult the dealer or an experienced radio/TV technician for help.

3.2 Canada

3.2.1 For EVMs issued with an Industry Canada Certificate of Conformance to RSS-210 or RSS-247

Concerning EVMs Including Radio Transmitters:

This device complies with Industry Canada license-exempt RSSs. Operation is subject to the following two conditions:

(1) this device may not cause interference, and (2) this device must accept any interference, including interference that may cause undesired operation of the device.

Concernant les EVMs avec appareils radio:

Le présent appareil est conforme aux CNR d'Industrie Canada applicables aux appareils radio exempts de licence. L'exploitation est autorisée aux deux conditions suivantes: (1) l'appareil ne doit pas produire de brouillage, et (2) l'utilisateur de l'appareil doit accepter tout brouillage radioélectrique subi, même si le brouillage est susceptible d'en compromettre le fonctionnement.

Concerning EVMs Including Detachable Antennas:

Under Industry Canada regulations, this radio transmitter may only operate using an antenna of a type and maximum (or lesser) gain approved for the transmitter by Industry Canada. To reduce potential radio interference to other users, the antenna type and its gain should be so chosen that the equivalent isotropically radiated power (e.i.r.p.) is not more than that necessary for successful communication. This radio transmitter has been approved by Industry Canada to operate with the antenna types listed in the user guide with the maximum permissible gain and required antenna impedance for each antenna type indicated. Antenna types not included in this list, having a gain greater than the maximum gain indicated for that type, are strictly prohibited for use with this device.

Concernant les EVMs avec antennes détachables

Conformément à la réglementation d'Industrie Canada, le présent émetteur radio peut fonctionner avec une antenne d'un type et d'un gain maximal (ou inférieur) approuvé pour l'émetteur par Industrie Canada. Dans le but de réduire les risques de brouillage radioélectrique à l'intention des autres utilisateurs, il faut choisir le type d'antenne et son gain de sorte que la puissance isotrope rayonnée équivalente (p.i.r.e.) ne dépasse pas l'intensité nécessaire à l'établissement d'une communication satisfaisante. Le présent émetteur radio a été approuvé par Industrie Canada pour fonctionner avec les types d'antenne énumérés dans le manuel d'usage et ayant un gain admissible maximal et l'impédance requise pour chaque type d'antenne. Les types d'antenne non inclus dans cette liste, ou dont le gain est supérieur au gain maximal indiqué, sont strictement interdits pour l'exploitation de l'émetteur.

3.3 Japan

3.3.1 *Notice for EVMs delivered in Japan:* Please see http://www.tij.co.jp/lstds/ti_ja/general/eStore/notice_01.page 日本国内に輸入される評価用キット、ボードについては、次のところをご覧ください。
http://www.tij.co.jp/lstds/ti_ja/general/eStore/notice_01.page

3.3.2 *Notice for Users of EVMs Considered "Radio Frequency Products" in Japan:* EVMs entering Japan may not be certified by TI as conforming to Technical Regulations of Radio Law of Japan.

If User uses EVMs in Japan, not certified to Technical Regulations of Radio Law of Japan, User is required to follow the instructions set forth by Radio Law of Japan, which includes, but is not limited to, the instructions below with respect to EVMs (which for the avoidance of doubt are stated strictly for convenience and should be verified by User):

1. Use EVMs in a shielded room or any other test facility as defined in the notification #173 issued by Ministry of Internal Affairs and Communications on March 28, 2006, based on Sub-section 1.1 of Article 6 of the Ministry's Rule for Enforcement of Radio Law of Japan,
2. Use EVMs only after User obtains the license of Test Radio Station as provided in Radio Law of Japan with respect to EVMs, or
3. Use of EVMs only after User obtains the Technical Regulations Conformity Certification as provided in Radio Law of Japan with respect to EVMs. Also, do not transfer EVMs, unless User gives the same notice above to the transferee. Please note that if User does not follow the instructions above, User will be subject to penalties of Radio Law of Japan.

【無線電波を送信する製品の開発キットをお使いになる際の注意事項】 開発キットの中には技術基準適合証明を受けていないものがあります。技術適合証明を受けていないものご使用に際しては、電波法遵守のため、以下のいずれかの措置を取っていただく必要がありますのでご注意ください。

1. 電波法施行規則第6条第1項第1号に基づく平成18年3月28日総務省告示第173号で定められた電波暗室等の試験設備でご使用いただく。
2. 実験局の免許を取得後ご使用いただく。
3. 技術基準適合証明を取得後ご使用いただく。

なお、本製品は、上記の「ご使用にあたっての注意」を譲渡先、移転先に通知しない限り、譲渡、移転できないものとします。

上記を遵守頂けない場合は、電波法の罰則が適用される可能性があることをご留意ください。日本テキサス・インスツルメンツ株式会社
東京都新宿区西新宿 6 丁目 2 4 番 1 号
西新宿三井ビル

3.3.3 *Notice for EVMs for Power Line Communication:* Please see http://www.tij.co.jp/llds/ti_ja/general/eStore/notice_02.page
電力線搬送波通信についての開発キットをお使いになる際の注意事項については、次のところをご覧ください。 http://www.tij.co.jp/llds/ti_ja/general/eStore/notice_02.page

3.4 *European Union*

3.4.1 *For EVMs subject to EU Directive 2014/30/EU (Electromagnetic Compatibility Directive):*

This is a class A product intended for use in environments other than domestic environments that are connected to a low-voltage power-supply network that supplies buildings used for domestic purposes. In a domestic environment this product may cause radio interference in which case the user may be required to take adequate measures.

4 *EVM Use Restrictions and Warnings:*

4.1 EVMS ARE NOT FOR USE IN FUNCTIONAL SAFETY AND/OR SAFETY CRITICAL EVALUATIONS, INCLUDING BUT NOT LIMITED TO EVALUATIONS OF LIFE SUPPORT APPLICATIONS.

4.2 User must read and apply the user guide and other available documentation provided by TI regarding the EVM prior to handling or using the EVM, including without limitation any warning or restriction notices. The notices contain important safety information related to, for example, temperatures and voltages.

4.3 *Safety-Related Warnings and Restrictions:*

4.3.1 User shall operate the EVM within TI's recommended specifications and environmental considerations stated in the user guide, other available documentation provided by TI, and any other applicable requirements and employ reasonable and customary safeguards. Exceeding the specified performance ratings and specifications (including but not limited to input and output voltage, current, power, and environmental ranges) for the EVM may cause personal injury or death, or property damage. If there are questions concerning performance ratings and specifications, User should contact a TI field representative prior to connecting interface electronics including input power and intended loads. Any loads applied outside of the specified output range may also result in unintended and/or inaccurate operation and/or possible permanent damage to the EVM and/or interface electronics. Please consult the EVM user guide prior to connecting any load to the EVM output. If there is uncertainty as to the load specification, please contact a TI field representative. During normal operation, even with the inputs and outputs kept within the specified allowable ranges, some circuit components may have elevated case temperatures. These components include but are not limited to linear regulators, switching transistors, pass transistors, current sense resistors, and heat sinks, which can be identified using the information in the associated documentation. When working with the EVM, please be aware that the EVM may become very warm.

4.3.2 EVMs are intended solely for use by technically qualified, professional electronics experts who are familiar with the dangers and application risks associated with handling electrical mechanical components, systems, and subsystems. User assumes all responsibility and liability for proper and safe handling and use of the EVM by User or its employees, affiliates, contractors or designees. User assumes all responsibility and liability to ensure that any interfaces (electronic and/or mechanical) between the EVM and any human body are designed with suitable isolation and means to safely limit accessible leakage currents to minimize the risk of electrical shock hazard. User assumes all responsibility and liability for any improper or unsafe handling or use of the EVM by User or its employees, affiliates, contractors or designees.

4.4 User assumes all responsibility and liability to determine whether the EVM is subject to any applicable international, federal, state, or local laws and regulations related to User's handling and use of the EVM and, if applicable, User assumes all responsibility and liability for compliance in all respects with such laws and regulations. User assumes all responsibility and liability for proper disposal and recycling of the EVM consistent with all applicable international, federal, state, and local requirements.

5. *Accuracy of Information:* To the extent TI provides information on the availability and function of EVMs, TI attempts to be as accurate as possible. However, TI does not warrant the accuracy of EVM descriptions, EVM availability or other information on its websites as accurate, complete, reliable, current, or error-free.

6. *Disclaimers:*
- 6.1 EXCEPT AS SET FORTH ABOVE, EVMS AND ANY MATERIALS PROVIDED WITH THE EVM (INCLUDING, BUT NOT LIMITED TO, REFERENCE DESIGNS AND THE DESIGN OF THE EVM ITSELF) ARE PROVIDED "AS IS" AND "WITH ALL FAULTS." TI DISCLAIMS ALL OTHER WARRANTIES, EXPRESS OR IMPLIED, REGARDING SUCH ITEMS, INCLUDING BUT NOT LIMITED TO ANY EPIDEMIC FAILURE WARRANTY OR IMPLIED WARRANTIES OF MERCHANTABILITY OR FITNESS FOR A PARTICULAR PURPOSE OR NON-INFRINGEMENT OF ANY THIRD PARTY PATENTS, COPYRIGHTS, TRADE SECRETS OR OTHER INTELLECTUAL PROPERTY RIGHTS.
- 6.2 EXCEPT FOR THE LIMITED RIGHT TO USE THE EVM SET FORTH HEREIN, NOTHING IN THESE TERMS SHALL BE CONSTRUED AS GRANTING OR CONFERRING ANY RIGHTS BY LICENSE, PATENT, OR ANY OTHER INDUSTRIAL OR INTELLECTUAL PROPERTY RIGHT OF TI, ITS SUPPLIERS/LICENSORS OR ANY OTHER THIRD PARTY, TO USE THE EVM IN ANY FINISHED END-USER OR READY-TO-USE FINAL PRODUCT, OR FOR ANY INVENTION, DISCOVERY OR IMPROVEMENT, REGARDLESS OF WHEN MADE, CONCEIVED OR ACQUIRED.
7. *USER'S INDEMNITY OBLIGATIONS AND REPRESENTATIONS.* USER WILL DEFEND, INDEMNIFY AND HOLD TI, ITS LICENSORS AND THEIR REPRESENTATIVES HARMLESS FROM AND AGAINST ANY AND ALL CLAIMS, DAMAGES, LOSSES, EXPENSES, COSTS AND LIABILITIES (COLLECTIVELY, "CLAIMS") ARISING OUT OF OR IN CONNECTION WITH ANY HANDLING OR USE OF THE EVM THAT IS NOT IN ACCORDANCE WITH THESE TERMS. THIS OBLIGATION SHALL APPLY WHETHER CLAIMS ARISE UNDER STATUTE, REGULATION, OR THE LAW OF TORT, CONTRACT OR ANY OTHER LEGAL THEORY, AND EVEN IF THE EVM FAILS TO PERFORM AS DESCRIBED OR EXPECTED.
8. *Limitations on Damages and Liability:*
- 8.1 *General Limitations.* IN NO EVENT SHALL TI BE LIABLE FOR ANY SPECIAL, COLLATERAL, INDIRECT, PUNITIVE, INCIDENTAL, CONSEQUENTIAL, OR EXEMPLARY DAMAGES IN CONNECTION WITH OR ARISING OUT OF THESE TERMS OR THE USE OF THE EVMS , REGARDLESS OF WHETHER TI HAS BEEN ADVISED OF THE POSSIBILITY OF SUCH DAMAGES. EXCLUDED DAMAGES INCLUDE, BUT ARE NOT LIMITED TO, COST OF REMOVAL OR REINSTALLATION, ANCILLARY COSTS TO THE PROCUREMENT OF SUBSTITUTE GOODS OR SERVICES, RETESTING, OUTSIDE COMPUTER TIME, LABOR COSTS, LOSS OF GOODWILL, LOSS OF PROFITS, LOSS OF SAVINGS, LOSS OF USE, LOSS OF DATA, OR BUSINESS INTERRUPTION. NO CLAIM, SUIT OR ACTION SHALL BE BROUGHT AGAINST TI MORE THAN TWELVE (12) MONTHS AFTER THE EVENT THAT GAVE RISE TO THE CAUSE OF ACTION HAS OCCURRED.
- 8.2 *Specific Limitations.* IN NO EVENT SHALL TI'S AGGREGATE LIABILITY FROM ANY USE OF AN EVM PROVIDED HEREUNDER, INCLUDING FROM ANY WARRANTY, INDEMNITY OR OTHER OBLIGATION ARISING OUT OF OR IN CONNECTION WITH THESE TERMS, , EXCEED THE TOTAL AMOUNT PAID TO TI BY USER FOR THE PARTICULAR EVM(S) AT ISSUE DURING THE PRIOR TWELVE (12) MONTHS WITH RESPECT TO WHICH LOSSES OR DAMAGES ARE CLAIMED. THE EXISTENCE OF MORE THAN ONE CLAIM SHALL NOT ENLARGE OR EXTEND THIS LIMIT.
9. *Return Policy.* Except as otherwise provided, TI does not offer any refunds, returns, or exchanges. Furthermore, no return of EVM(s) will be accepted if the package has been opened and no return of the EVM(s) will be accepted if they are damaged or otherwise not in a resalable condition. If User feels it has been incorrectly charged for the EVM(s) it ordered or that delivery violates the applicable order, User should contact TI. All refunds will be made in full within thirty (30) working days from the return of the components(s), excluding any postage or packaging costs.
10. *Governing Law:* These terms and conditions shall be governed by and interpreted in accordance with the laws of the State of Texas, without reference to conflict-of-laws principles. User agrees that non-exclusive jurisdiction for any dispute arising out of or relating to these terms and conditions lies within courts located in the State of Texas and consents to venue in Dallas County, Texas. Notwithstanding the foregoing, any judgment may be enforced in any United States or foreign court, and TI may seek injunctive relief in any United States or foreign court.

IMPORTANT NOTICE FOR TI DESIGN INFORMATION AND RESOURCES

Texas Instruments Incorporated ("TI") technical, application or other design advice, services or information, including, but not limited to, reference designs and materials relating to evaluation modules, (collectively, "TI Resources") are intended to assist designers who are developing applications that incorporate TI products; by downloading, accessing or using any particular TI Resource in any way, you (individually or, if you are acting on behalf of a company, your company) agree to use it solely for this purpose and subject to the terms of this Notice.

TI's provision of TI Resources does not expand or otherwise alter TI's applicable published warranties or warranty disclaimers for TI products, and no additional obligations or liabilities arise from TI providing such TI Resources. TI reserves the right to make corrections, enhancements, improvements and other changes to its TI Resources.

You understand and agree that you remain responsible for using your independent analysis, evaluation and judgment in designing your applications and that you have full and exclusive responsibility to assure the safety of your applications and compliance of your applications (and of all TI products used in or for your applications) with all applicable regulations, laws and other applicable requirements. You represent that, with respect to your applications, you have all the necessary expertise to create and implement safeguards that (1) anticipate dangerous consequences of failures, (2) monitor failures and their consequences, and (3) lessen the likelihood of failures that might cause harm and take appropriate actions. You agree that prior to using or distributing any applications that include TI products, you will thoroughly test such applications and the functionality of such TI products as used in such applications. TI has not conducted any testing other than that specifically described in the published documentation for a particular TI Resource.

You are authorized to use, copy and modify any individual TI Resource only in connection with the development of applications that include the TI product(s) identified in such TI Resource. NO OTHER LICENSE, EXPRESS OR IMPLIED, BY ESTOPPEL OR OTHERWISE TO ANY OTHER TI INTELLECTUAL PROPERTY RIGHT, AND NO LICENSE TO ANY TECHNOLOGY OR INTELLECTUAL PROPERTY RIGHT OF TI OR ANY THIRD PARTY IS GRANTED HEREIN, including but not limited to any patent right, copyright, mask work right, or other intellectual property right relating to any combination, machine, or process in which TI products or services are used. Information regarding or referencing third-party products or services does not constitute a license to use such products or services, or a warranty or endorsement thereof. Use of TI Resources may require a license from a third party under the patents or other intellectual property of the third party, or a license from TI under the patents or other intellectual property of TI.

TI RESOURCES ARE PROVIDED "AS IS" AND WITH ALL FAULTS. TI DISCLAIMS ALL OTHER WARRANTIES OR REPRESENTATIONS, EXPRESS OR IMPLIED, REGARDING TI RESOURCES OR USE THEREOF, INCLUDING BUT NOT LIMITED TO ACCURACY OR COMPLETENESS, TITLE, ANY EPIDEMIC FAILURE WARRANTY AND ANY IMPLIED WARRANTIES OF MERCHANTABILITY, FITNESS FOR A PARTICULAR PURPOSE, AND NON-INFRINGEMENT OF ANY THIRD PARTY INTELLECTUAL PROPERTY RIGHTS.

TI SHALL NOT BE LIABLE FOR AND SHALL NOT DEFEND OR INDEMNIFY YOU AGAINST ANY CLAIM, INCLUDING BUT NOT LIMITED TO ANY INFRINGEMENT CLAIM THAT RELATES TO OR IS BASED ON ANY COMBINATION OF PRODUCTS EVEN IF DESCRIBED IN TI RESOURCES OR OTHERWISE. IN NO EVENT SHALL TI BE LIABLE FOR ANY ACTUAL, DIRECT, SPECIAL, COLLATERAL, INDIRECT, PUNITIVE, INCIDENTAL, CONSEQUENTIAL OR EXEMPLARY DAMAGES IN CONNECTION WITH OR ARISING OUT OF TI RESOURCES OR USE THEREOF, AND REGARDLESS OF WHETHER TI HAS BEEN ADVISED OF THE POSSIBILITY OF SUCH DAMAGES.

You agree to fully indemnify TI and its representatives against any damages, costs, losses, and/or liabilities arising out of your non-compliance with the terms and provisions of this Notice.

This Notice applies to TI Resources. Additional terms apply to the use and purchase of certain types of materials, TI products and services. These include; without limitation, TI's standard terms for semiconductor products (<http://www.ti.com/sc/docs/stdterms.htm>), [evaluation modules](#), and [samples](http://www.ti.com/sc/docs/sampterm.htm) (<http://www.ti.com/sc/docs/sampterm.htm>).

Mailing Address: Texas Instruments, Post Office Box 655303, Dallas, Texas 75265
Copyright © 2017, Texas Instruments Incorporated