



Main

Range of Product	Telemecanique Photoelectric sensors XU
Series name	Application packaging
Electronic sensor type	Photo-electric sensor
Sensor name	XUK
Sensor design	Compact 50 x 50
Detection system	Reflex
Material	Plastic
Type of output signal	Discrete
Supply circuit type	DC
Wiring Technique	3-wire
Discrete output type	PNP or NPN
Discrete output function	1 NO or 1 NC programmable
Electrical connection	Cable
Cable length	6.56 ft (2 m)
Product Specific Application	Detection of transparent object
Emission	Red reflex
[Sn] nominal sensing distance	4.92 ft (1.5 m) reflex need reflector XUZC50

Complementary

Enclosure Material	PC
Lens material	PMMA
Output Type	Solid state
Output function governance	Dark
Add on output	Without
Cable composition	2 x 0.34 mm ²
Wire insulation material	PVC
Cable outer diameter	0.24 in (6 mm)
Status LED	1 LED Output state
[Us] rated supply voltage	12...24 V DC reverse polarity protection
Supply voltage limits	10...30 V AC/DC
Switching capacity in mA	<= 100 mA (overload and short-circuit protection)
Switching frequency	<= 1.5 kHz
Maximum voltage drop	<2 V (closed state)
Current consumption	<= 35 mA no-load
Time delay range	0.1...5 s monostable, on-delay or off-delay (programmable)
Maximum delay first up	80 ms
Maximum delay response	0.3 ms
Maximum delay recovery	0.3 ms
Setting-up	Sensitivity adjustment by potentiometer
Depth	1.97 in (50 mm)
Height	1.97 in (50 mm)
Width	0.71 in (18 mm)
Net Weight	0.08 lb(US) (0.035 kg)
Kit composition	Bracket XULZ41 Sensor

Environment

Product Certifications	CE UL CSA
Ambient air temperature for operation	-13...131 °F (-25...55 °C)
Ambient Air Temperature for Storage	-40...158 °F (-40...70 °C)
Vibration resistance	7 gn +/- 2 mm 10...55 Hz) IEC 60068-2-6
Shock resistance	20 gn 11 ms) IEC 60068-2-27
IP degree of protection	IP65 IEC 60529 IP651 NF C 20-010





Ordering and shipping details

Category	22481-SENSORS, PHOTOELECTRIC
Discount Schedule	DS2
GTIN	3389110077216
Nbr. of units in pkg.	1
Package weight(Lbs)	8.96 oz (254.0 g)
Returnability	No
Country of origin	ID

Packing Units

Unit Type of Package 1	PCE
Package 1 Height	1.65 in (4.2 cm)
Package 1 width	3.82 in (9.7 cm)
Package 1 Length	5.20 in (13.2 cm)
Unit Type of Package 2	S02
Number of Units in Package 2	12
Package 2 Weight	7.61 lb(US) (3.45 kg)
Package 2 Height	5.91 in (15 cm)
Package 2 width	11.81 in (30 cm)
Package 2 Length	15.75 in (40 cm)

Offer Sustainability

Sustainable offer status	Green Premium product
California proposition 65	WARNING: This product can expose you to chemicals including: Diisononyl phthalate (DINP), which is known to the State of California to cause cancer, and Di-isodecyl phthalate (DIDP), which is known to the State of California to cause birth defects or other reproductive harm. For more information go to www.P65Warnings.ca.gov
REACH Regulation	 REACH Declaration
EU RoHS Directive	Pro-active compliance (Product out of EU RoHS legal scope)  EU RoHS Declaration
Mercury free	Yes
RoHS exemption information	 Yes
Environmental Disclosure	 Product Environmental Profile
Circularity Profile	 End Of Life Information

Contractual warranty

Warranty	18 months
----------	-----------

Dimensions

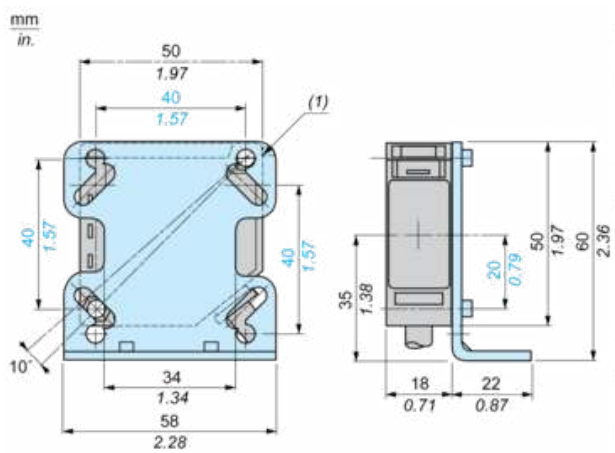

(1) Cover locking tongue

Bracket Fixing

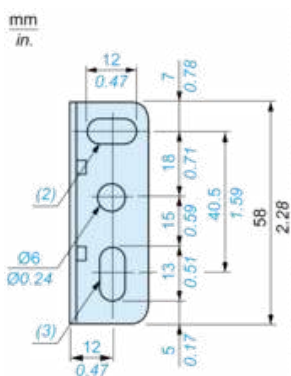

(2) 1 elongated hole \varnothing 6 x 12

(3) 1 elongated hole \varnothing 6 x 13

Wiring Schemes

Connector Scheme

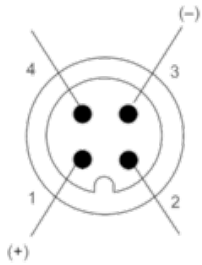

- 1 : (+)
- 2 : Alarm output
- 3 : (-)
- 4 : Output signal

NC Programmed

PNP programmed output

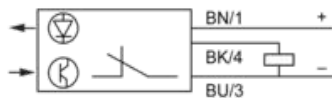

- BN : Brown
- BK : Black
- BU : Blue

NPN programmed output

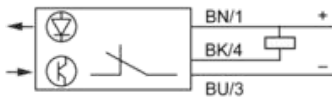

- BN : Brown
- BK : Black
- BU : Blue

NO Programmed

PNP programmed output

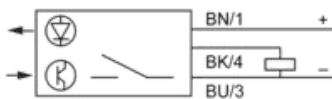

- BN : Brown
- BK : Black
- BU : Blue

NPN programmed output

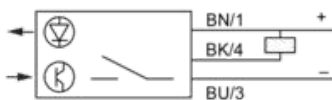

- BN : Brown
- BK : Black
- BU : Blue

Alarm Output

PNP programmed

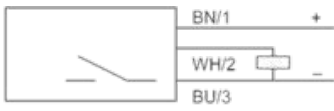

BN : Brown

WH : White

BU : Blue

NPN programmed

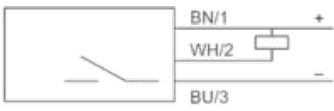

BN : Brown

WH : White

BU : Blue