

### FEATURES

**2.3 V to 5.5 V power supply**  
**MCLK speed: 16 MHz (B grade), 5 MHz (A grade)**  
**Output frequency up to 8 MHz**  
**Sinusoidal and triangular outputs**  
**On-board comparator**  
**3-wire SPI interface**  
**Extended temperature range: -40°C to +125°C**  
**Power-down option**  
**11 mW power consumption at 2.3 V**  
**20-lead LFCSP**

### APPLICATIONS

**Frequency stimulus/waveform generation**  
**Frequency phase tuning and modulation**  
**Low power RF/communications systems**  
**Liquid and gas flow measurement**  
**Sensory applications: proximity, motion, and defect detection**  
**Test and medical equipment**

### GENERAL DESCRIPTION

The **AD9838** is a low power DDS device capable of producing high performance sine and triangular outputs. It also has an on-board comparator that allows a square wave to be produced for clock generation. Consuming only 11 mW of power at 2.3 V, the AD9838 is an ideal candidate for power-sensitive applications.

Capability for phase modulation and frequency modulation is provided. The frequency registers are 28 bits wide: with a 16 MHz clock rate, resolution of 0.06 Hz can be achieved; with a 5 MHz clock rate, the AD9838 can be tuned to 0.02 Hz resolution. Frequency and phase modulation are configured by loading registers through the serial interface and by toggling the registers using software or the FSELECT and PSELECT pins, respectively.

The AD9838 is written to via a 3-wire serial interface. This serial interface operates at clock rates up to 40 MHz and is compatible with DSP and microcontroller standards.

The device operates with a power supply from 2.3 V to 5.5 V. The analog and digital sections are independent and can be run from different power supplies; for example, AVDD can equal 5 V with DVDD equal to 3 V.

The AD9838 has a power-down pin (SLEEP) that allows external control of the power-down mode. Sections of the device that are not being used can be powered down to minimize current consumption. For example, the DAC can be powered down when a clock output is being generated.

The AD9838 is available in a 20-lead LFCSP\_WQ package.

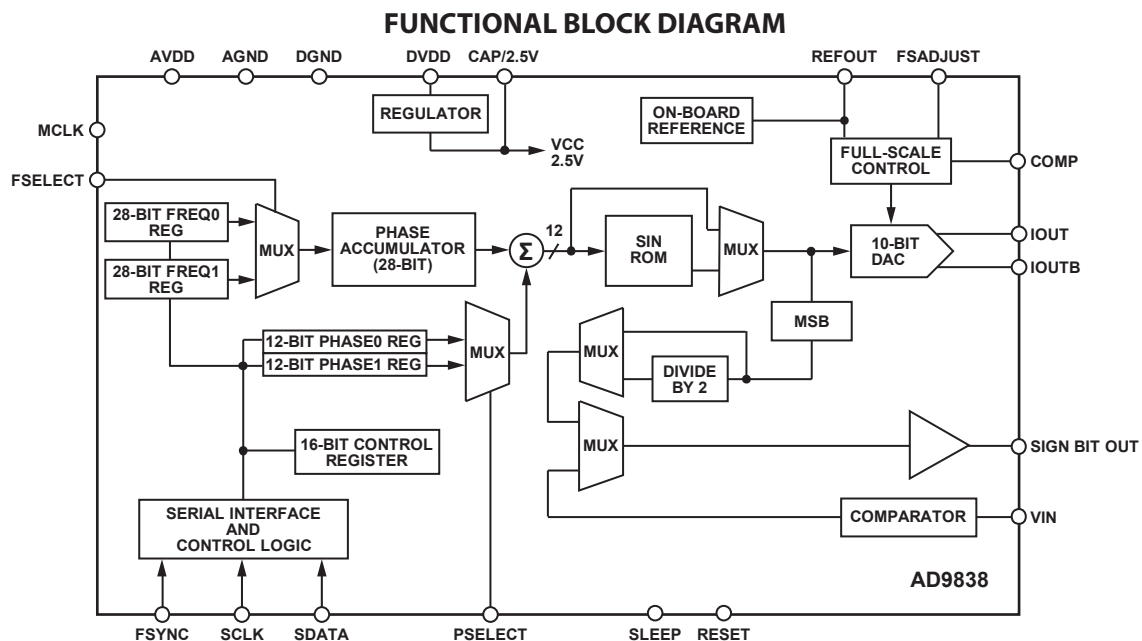

Figure 1.

#### Rev. A

Information furnished by Analog Devices is believed to be accurate and reliable. However, no responsibility is assumed by Analog Devices for its use, nor for any infringements of patents or other rights of third parties that may result from its use. Specifications subject to change without notice. No license is granted by implication or otherwise under any patent or patent rights of Analog Devices. Trademarks and registered trademarks are the property of their respective owners.

## TABLE OF CONTENTS

|  |    |   |    |
|--|----|---|----|
| Features .....   | 1  | Functional Description .....                | 17 |
| Applications .....   | 1  | Serial Interface .....                      | 17 |
| General Description .....                                  | 1  | Latency Period .....                        | 17 |
| Functional Block Diagram .....                             | 1  | Control Register .....                      | 17 |
| Revision History .....                                     | 2  | Frequency and Phase Registers .....         | 19 |
| Specifications .....                                       | 3  | Reset Function .....                        | 20 |
| Timing Characteristics .....                               | 5  | Sleep Function .....                        | 20 |
| Absolute Maximum Ratings .....                             | 6  | SIGN BIT OUT Pin .....                      | 21 |
| Thermal Resistance .....                                   | 6  | IOUT and IOUTB Pins .....                   | 21 |
| ESD Caution .....  | 6  | Powering Up the AD9838 .....                | 21 |
| Pin Configuration and Function Descriptions .....          | 7  | Applications Information .....              | 24 |
| Typical Performance Characteristics .....                  | 9  | Grounding and Layout .....                  | 24 |
| Test Circuit .....   | 12 | Interfacing to Microprocessors .....        | 24 |
| Terminology .....  | 13 | Evaluation Board .....                      | 26 |
| Theory of Operation .....                                  | 14 | System Demonstration Platform .....         | 26 |
| Circuit Description .....                                  | 15 | AD9838 to SPORT Interface .....             | 26 |
| Numerically Controlled Oscillator Plus Phase Modulator ... | 15 | Evaluation Kit .....                        | 26 |
| SIN ROM .....  | 15 | Crystal Oscillator vs. External Clock ..... | 26 |
| Digital-to-Analog Converter (DAC) .....                    | 15 | Power Supply .....                          | 26 |
| Comparator .....   | 15 | Evaluation Board Schematics .....           | 27 |
| Regulator .....  | 16 | Evaluation Board Layout .....               | 29 |
|  |    | Outline Dimensions .....                    | 30 |
|  |    | Ordering Guide .....                        | 30 |

## REVISION HISTORY

### 4/11—Rev. 0 to Rev. A

|                          |   |
|--------------------------|---|
| Change to Title .....    | 1 |
| Change to Figure 3 ..... | 5 |
| Change to Figure 8 ..... | 9 |

### 4/11—Revision 0: Initial Version

## SPECIFICATIONS

AVDD = DVDD = 2.3 V to 5.5 V, AGND = DGND = 0 V, T<sub>A</sub> = T<sub>MIN</sub> to T<sub>MAX</sub>, R<sub>SET</sub> = 6.8 k $\Omega$ , R<sub>LOAD</sub> = 200  $\Omega$  for IOUT and IOUTB, unless otherwise noted.

Table 1.

| Parameter <sup>1</sup>                   | Min  | Typ  | Max  | Unit              | Test Conditions/Comments   |
|--|------|------|------|-------------------|--|
| <b>SIGNAL DAC SPECIFICATIONS</b>         |      |      |      |                   |  |
| Resolution                               |      | 10   |      | Bits              |  |
| Update Rate                              |      |      |      |                   |  |
| A Grade                                  |      |      | 5    | MSPS              |  |
| B Grade                                  |      |      | 16   | MSPS              |  |
| I <sub>OUT</sub> Full Scale <sup>2</sup> |      | 3.0  |      | mA                |  |
| V <sub>OUT</sub> Maximum                 |      | 0.6  |      | V                 |  |
| V <sub>OUT</sub> Minimum                 |      | 30   |      | mV                |  |
| Output Compliance <sup>3</sup>           |      |      | 0.8  | V                 |  |
| DC Accuracy                              |      |      |      |                   |  |
| Integral Nonlinearity (INL)              |      | ±1   |      | LSB               |  |
| Differential Nonlinearity (DNL)          |      | ±0.5 |      | LSB               |  |
| <b>DDS SPECIFICATIONS</b>                |      |      |      |                   |  |
| Dynamic Specifications                   |      |      |      |                   |  |
| Signal-to-Noise Ratio (SNR)              |      |      |      |                   |  |
| A Grade                                  |      | -63  |      | dB                | f <sub>MCLK</sub> = 5 MHz, f <sub>OUT</sub> = f <sub>MCLK</sub> /4096  |
| B Grade                                  |      | -64  |      | dB                | f <sub>MCLK</sub> = 16 MHz, f <sub>OUT</sub> = f <sub>MCLK</sub> /4096 |
| Total Harmonic Distortion (THD)          |      |      |      |                   |  |
| A Grade                                  |      | -64  |      | dBc               | f <sub>MCLK</sub> = 5 MHz, f <sub>OUT</sub> = f <sub>MCLK</sub> /4096  |
| B Grade                                  |      | -64  |      | dBc               | f <sub>MCLK</sub> = 16 MHz, f <sub>OUT</sub> = f <sub>MCLK</sub> /4096 |
| Spurious-Free Dynamic Range (SFDR)       |      |      |      |                   |  |
| Wideband (0 to Nyquist)                  |      |      |      |                   |  |
| A Grade                                  |      | -68  |      | dBc               | f <sub>MCLK</sub> = 5 MHz, f <sub>OUT</sub> = f <sub>MCLK</sub> /50    |
| B Grade                                  |      | -66  |      | dBc               | f <sub>MCLK</sub> = 16 MHz, f <sub>OUT</sub> = f <sub>MCLK</sub> /50   |
| Narrow-Band ( $\pm 200$ kHz)             |      |      |      |                   |  |
| A Grade                                  |      | -97  |      | dBc               | f <sub>MCLK</sub> = 5 MHz, f <sub>OUT</sub> = f <sub>MCLK</sub> /50    |
| B Grade                                  |      | -92  |      | dBc               | f <sub>MCLK</sub> = 16 MHz, f <sub>OUT</sub> = f <sub>MCLK</sub> /50   |
| Clock Feedthrough                        |      |      |      |                   |  |
| A Grade                                  |      | -68  |      | dBc               | f <sub>MCLK</sub> = 5 MHz, f <sub>OUT</sub> = reset                    |
| B Grade                                  |      | -65  |      | dBc               | f <sub>MCLK</sub> = 16 MHz, f <sub>OUT</sub> = reset                   |
| Wake-Up Time                             |      | 1    |      | ms                |  |
| <b>COMPARATOR</b>                        |      |      |      |                   |  |
| Input Voltage Range                      |      |      | 1    | V p-p             | AC-coupled internally  |
| Input Capacitance                        |      | 10   |      | pF                |  |
| Input High-Pass Cutoff Frequency         |      | 3    |      | MHz               |  |
| Input DC Resistance                      |      | 5    |      | M $\Omega$        |  |
| Input Leakage Current                    |      |      | 10   | $\mu$ A           |  |
| <b>OUTPUT BUFFER</b>                     |      |      |      |                   |  |
| Output Rise/Fall Time                    |      | 12   |      | ns                | Using a 15 pF load   |
| Output Jitter                            |      | 120  |      | ps rms            | 3 MHz sine wave 0.6 V p-p  |
| <b>VOLTAGE REFERENCE</b>                 |      |      |      |                   |  |
| Internal Reference                       | 1.11 | 1.18 | 1.24 | V                 |  |
| REFOUT Output Impedance <sup>4</sup>     |      | 1    |      | k $\Omega$        |  |
| Reference TC                             |      | 100  |      | ppm/ $^{\circ}$ C |  |
| FSADJUST Voltage                         |      | 1.14 |      | V                 |  |

# AD9838

| Parameter <sup>1</sup>           | Min | Typ | Max | Unit    | Test Conditions/Comments                                |
|----------------------------------|-----|-----|-----|---------|---|
| LOGIC INPUTS                     |     |     |     |         |   |
| Input High Voltage, $V_{INH}$    | 1.7 |     |     | V       | 2.3 V to 2.7 V power supply                             |
|                                  | 2.0 |     |     | V       | 2.7 V to 3.6 V power supply                             |
|                                  | 2.8 |     |     | V       | 4.5 V to 5.5 V power supply                             |
| Input Low Voltage, $V_{INL}$     |     |     | 0.6 | V       | 2.3 V to 2.7 V power supply                             |
|                                  |     |     | 0.7 | V       | 2.7 V to 3.6 V power supply                             |
|                                  |     |     | 0.8 | V       | 4.5 V to 5.5 V power supply                             |
| Input Current, $I_{INH}/I_{INL}$ |     |     | 10  | $\mu$ A |   |
| Input Capacitance, $C_{IN}$      |     | 3   |     | pF      |   |
| POWER SUPPLIES                   |     |     |     |         |   |
| AVDD                             | 2.3 |     | 5.5 | V       | $f_{MCLK} = 16 \text{ MHz}$ , $f_{OUT} = f_{MCLK}/4096$ |
| DVDD                             | 2.3 |     | 5.5 | V       |   |
| $I_{AA}$ <sup>5</sup>            |     | 3.7 | 5   | mA      | $I_{DD}$ code dependent; see Figure 7                   |
| $I_{DD}$ <sup>5</sup>            |     |     |     |         |   |
| A Grade                          |     | 0.9 | 2   | mA      |   |
| B Grade                          |     | 1.2 | 2.4 | mA      |   |
| $I_{AA} + I_{DD}$ <sup>5</sup>   |     |     |     |         | See Figure 6  |
| A Grade                          |     | 4.6 | 7   | mA      |   |
| B Grade                          |     | 4.9 | 7.4 | mA      |   |
| Low Power Sleep Mode             |     |     |     |         | DAC powered down; see Table 17                          |
| A Grade                          |     | 0.4 |     | mA      |   |
| B Grade                          |     | 0.4 |     | mA      |   |

<sup>1</sup> Operating temperature range is  $-40^{\circ}\text{C}$  to  $+125^{\circ}\text{C}$ ; typical specifications are at  $25^{\circ}\text{C}$ .

<sup>2</sup> For compliance with the specified load of  $200 \Omega$ ,  $I_{OUT}$  full scale should not exceed 4 mA.

<sup>3</sup> Guaranteed by design.

<sup>4</sup> Applies when REFOUT is sourcing current. The impedance is higher when REFOUT is sinking current.

<sup>5</sup> Measured with the digital inputs static and equal to 0 V or DVDD.

**TIMING CHARACTERISTICS**

DVDD = 2.3 V to 5.5 V, AGND = DGND = 0 V, unless otherwise noted.

Table 2.

| Parameter <sup>1</sup> | Limit at T <sub>MIN</sub> to T <sub>MAX</sub> | Unit   | Description   |
|------------------------|---|--------|---|
| t <sub>1</sub>         | 200/62.5                                      | ns min | MCLK period (5 MHz/16 MHz)                          |
| t <sub>2</sub>         | 80/26   | ns min | MCLK high duration (5 MHz/16 MHz)                   |
| t <sub>3</sub>         | 80/26   | ns min | MCLK low duration (5 MHz/16 MHz)                    |
| t <sub>4</sub>         | 25  | ns min | SCLK period   |
| t <sub>5</sub>         | 10  | ns min | SCLK high duration                                  |
| t <sub>6</sub>         | 10  | ns min | SCLK low duration                                   |
| t <sub>7</sub>         | 5   | ns min | FSYNC to SCLK falling edge setup time               |
| t <sub>8</sub>         | 10  | ns min | SCLK falling edge to FSYNC rising edge time         |
|                        | t <sub>4</sub> - 5                            | ns max |   |
| t <sub>9</sub>         | 5   | ns min | Data setup time                                     |
| t <sub>10</sub>        | 3   | ns min | Data hold time                                      |
| t <sub>11</sub>        | 8   | ns min | FSELECT, PSELECT setup time before MCLK rising edge |
| t <sub>11A</sub>       | 8   | ns min | FSELECT, PSELECT setup time after MCLK rising edge  |
| t <sub>12</sub>        | 5   | ns min | SCLK high to FSYNC falling edge setup time          |

<sup>1</sup> Guaranteed by design; not production tested.

**Timing Diagrams**

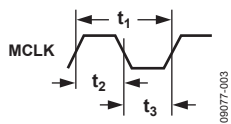

Figure 2. Master Clock

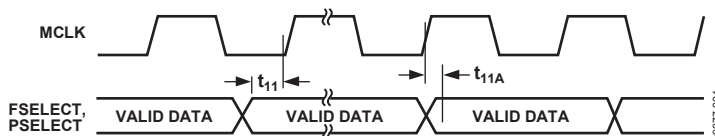

Figure 3. Control Timing

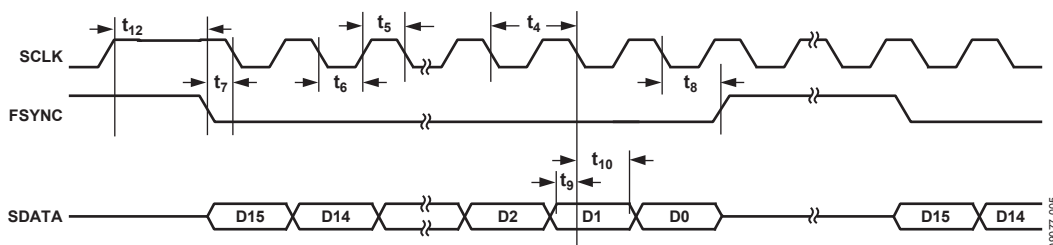

Figure 4. Serial Timing

## ABSOLUTE MAXIMUM RATINGS

$T_A = 25^\circ\text{C}$ , unless otherwise noted.

Table 3.

| Parameter                            | Rating                 |
|--------------------------------------|------------------------|
| AVDD to AGND                         | -0.3 V to +6 V         |
| DVDD to DGND                         | -0.3 V to +6 V         |
| AVDD to DVDD                         | -0.3 V to +0.3 V       |
| AGND to DGND                         | -0.3 V to +0.3 V       |
| CAP/2.5V                             | 2.75 V                 |
| Digital I/O Voltage to DGND          | -0.3 V to DVDD + 0.3 V |
| Analog I/O Voltage to AGND           | -0.3 V to AVDD + 0.3 V |
| Operating Temperature Range          |                        |
| Industrial (B Version)               | -40°C to +125°C        |
| Storage Temperature Range            | -65°C to +150°C        |
| Maximum Junction Temperature         | 150°C                  |
| Lead Temperature, Soldering (10 sec) | 300°C                  |
| IR Reflow, Peak Temperature          | 220°C                  |
| Reflow Soldering (Pb Free)           |                        |
| Peak Temperature                     | 260°C (+0/-5)          |
| Time at Peak Temperature             | 10 sec to 40 sec       |

Stresses above those listed under Absolute Maximum Ratings may cause permanent damage to the device. This is a stress rating only; functional operation of the device at these or any other conditions above those indicated in the operational section of this specification is not implied. Exposure to absolute maximum rating conditions for extended periods may affect device reliability.

### THERMAL RESISTANCE

$\theta_{JA}$  is specified for the worst-case conditions, that is, a device soldered in a circuit board for surface-mount packages.

Table 4. Thermal Resistance

| Package Type                | $\theta_{JA}$ | $\theta_{JC}$ | Unit                      |
|-----------------------------|---------------|---------------|---------------------------|
| 20-Lead LFCSP_WQ (CP-20-10) | 49.5          | 5.3           | $^\circ\text{C}/\text{W}$ |

### ESD CAUTION



**ESD (electrostatic discharge) sensitive device.** Charged devices and circuit boards can discharge without detection. Although this product features patented or proprietary protection circuitry, damage may occur on devices subjected to high energy ESD. Therefore, proper ESD precautions should be taken to avoid performance degradation or loss of functionality.

## PIN CONFIGURATION AND FUNCTION DESCRIPTIONS

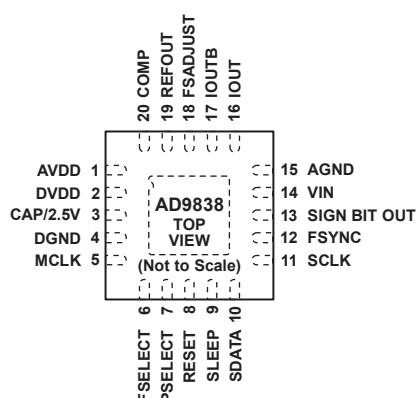

NOTES  
1. CONNECT EXPOSED PAD TO GROUND.

Figure 5. Pin Configuration

08077-006

Table 5. Pin Function Descriptions

| Pin No. | Mnemonic       | Description   |
|---------|----------------|---|
| 1       | AVDD           | Positive Power Supply for the Analog Section. AVDD can have a value from 2.3 V to 5.5 V. A 0.1 $\mu$ F decoupling capacitor should be connected between AVDD and AGND.  |
| 2       | DVDD           | Positive Power Supply for the Digital Section. DVDD can have a value from 2.3 V to 5.5 V. A 0.1 $\mu$ F decoupling capacitor should be connected between DVDD and DGND.   |
| 3       | CAP/2.5V       | The digital circuitry operates from a 2.5 V power supply. This 2.5 V is generated from DVDD using an on-board regulator when DVDD exceeds 2.7 V. The regulator requires a decoupling capacitor of 100 nF typical, which is connected from CAP/2.5V to DGND. If DVDD is less than or equal to 2.7 V, CAP/2.5V should be shorted to DVDD.         |
| 4       | DGND           | Digital Ground.   |
| 5       | MCLK           | Digital Clock Input. DDS output frequencies are expressed as a binary fraction of the frequency of MCLK. The output frequency accuracy and phase noise are determined by this clock.  |
| 6       | FSELECT        | Frequency Select Input. FSELECT controls which frequency register, FREQ0 or FREQ1, is used in the phase accumulator. The frequency register to be used can be selected using the FSELECT pin or the FSEL bit. When the FSEL bit is used to select the frequency register, the FSELECT pin should be tied to CMOS high or low.                   |
| 7       | PSELECT        | Phase Select Input. PSELECT controls which phase register, PHASE0 or PHASE1, is added to the phase accumulator output. The phase register to be used can be selected using the PSELECT pin or the PSEL bit. When the PSEL bit is used to select the phase register, the PSELECT pin should be tied to CMOS high or low.                         |
| 8       | RESET          | Active High Digital Input. This pin resets the appropriate internal registers to 0 (this corresponds to an analog output of midscale). RESET does not affect any of the addressable registers.  |
| 9       | SLEEP          | Active High Digital Input. When this pin is high, the DAC is powered down. This pin has the same function as the SLEEP12 control bit.   |
| 10      | SDATA          | Serial Data Input. The 16-bit serial data-word is applied to this input.  |
| 11      | SCLK           | Serial Clock Input. Data is clocked into the AD9838 on each falling edge of SCLK.   |
| 12      | FSYNC          | Active Low Control Input. FSYNC is the frame synchronization signal for the input data. When FSYNC is taken low, the internal logic is informed that a new word is being loaded into the device.  |
| 13      | SIGN BIT OUT   | Logic Output. The comparator output is available on this pin or, alternatively, the MSB from the NCO can be output on this pin. Setting the OPBITEN bit in the control register to 1 enables this output pin. The SIGN/PIB bit determines whether the comparator output or the MSB from the NCO is output on this pin.                          |
| 14      | VIN            | Input to Comparator. The comparator can be used to generate a square wave from the sinusoidal DAC output. The DAC output should be filtered appropriately before it is applied to the comparator to reduce jitter. When the OPBITEN and SIGN/PIB bits in the control register are set to 1, the comparator input is connected to VIN.           |
| 15      | AGND           | Analog Ground.  |
| 16, 17  | IOUT,<br>IOUTB | Current Output. This is a high impedance current source. A load resistor of nominally 200 $\Omega$ should be connected between IOUT and AGND. IOUTB should be tied to AGND through an external load resistor of 200 $\Omega$ , but it can be tied directly to AGND. A 20 pF capacitor to AGND is also recommended to prevent clock feedthrough. |

# AD9838

| Pin No. | Mnemonic | Description  |
|---------|----------|--|
| 18      | FSADJUST | Full-Scale Adjust Control. A resistor ( $R_{SET}$ ) is connected between this pin and AGND to determine the magnitude of the full-scale DAC current. The relationship between $R_{SET}$ and the full-scale current is as follows:<br>$I_{OUT\_FULL\ SCALE} = 18 \times FSADJUST / R_{SET}$ $FSADJUST = 1.14\text{ V nominal}, R_{SET} = 6.8\text{ k}\Omega\text{ typical}$ |
| 19      | REFOUT   | Voltage Reference Output. The AD9838 has an internal 1.20 V reference that is available at this pin.   |
| 20      | COMP     | DAC Bias Pin. This pin is used for decoupling the DAC bias voltage.  |
|         | EP       | Exposed Pad. Connect the exposed pad to ground.  |



# TYPICAL PERFORMANCE CHARACTERISTICS

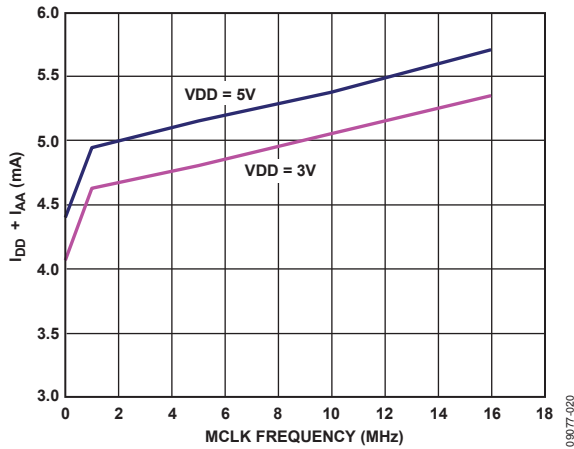

Figure 6. Typical Current Consumption ( $I_{DD} + I_{AA}$ ) vs. MCLK Frequency for  $f_{OUT} = MCLK/10$

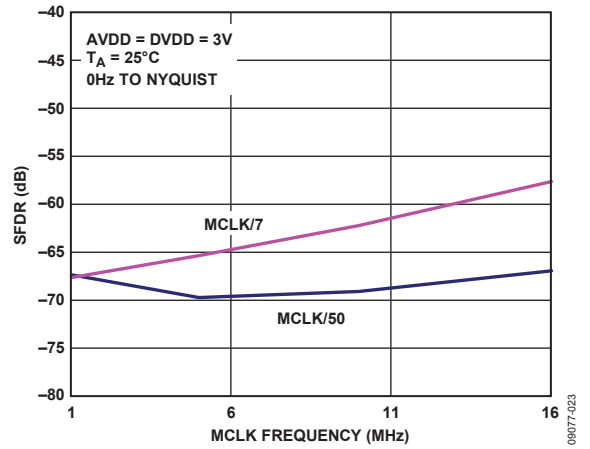

Figure 9. Wideband SFDR vs. MCLK Frequency

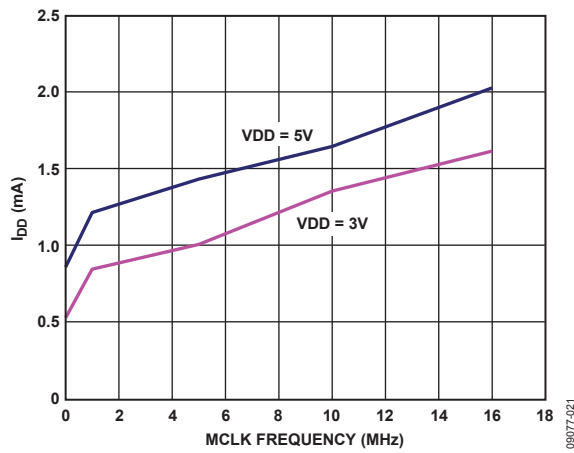

Figure 7. Typical Current Consumption ( $I_{DD}$ ) vs. MCLK Frequency for  $f_{OUT} = MCLK/10$

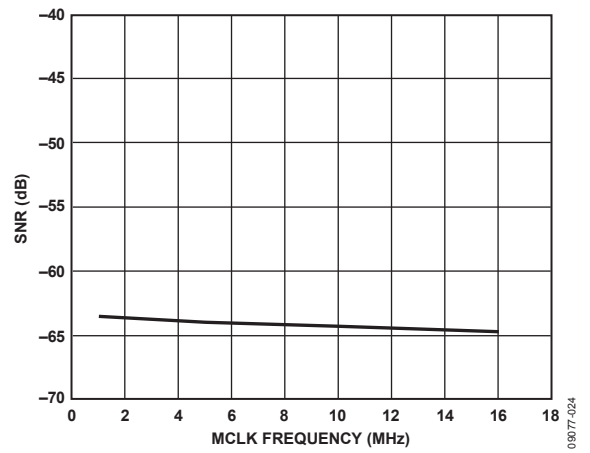

Figure 10. SNR vs. MCLK Frequency

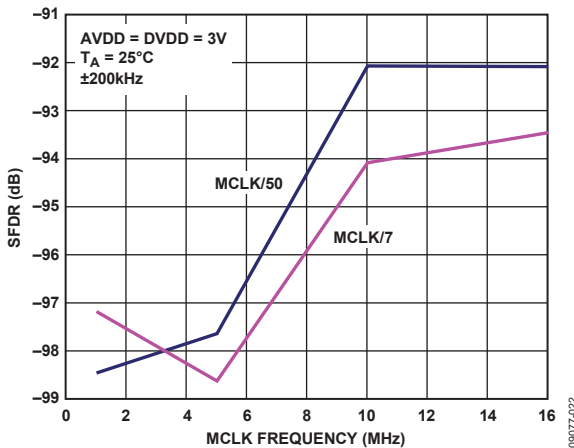

Figure 8. Narrow-Band SFDR vs. MCLK Frequency

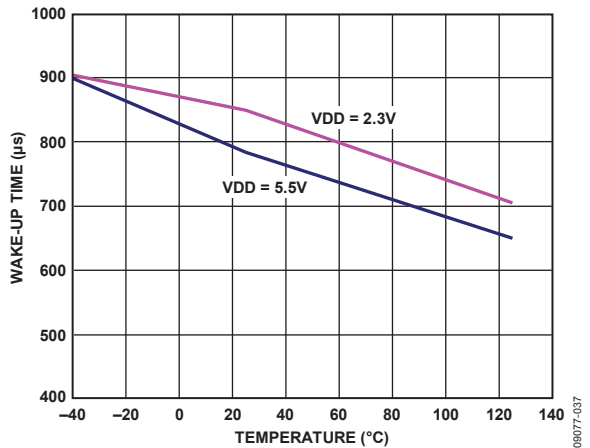

Figure 11. Wake-Up Time vs. Temperature

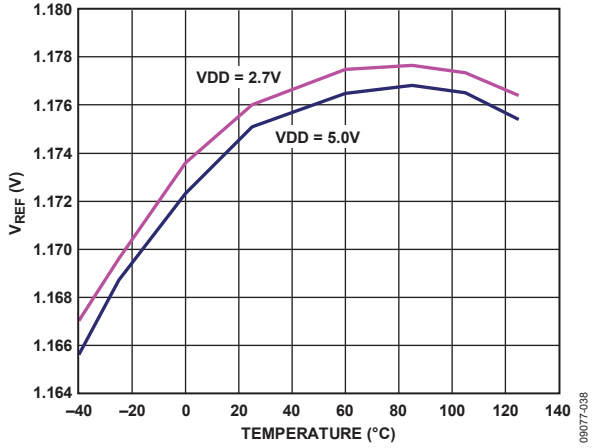

Figure 12.  $V_{REF}$  vs. Temperature

09077-038

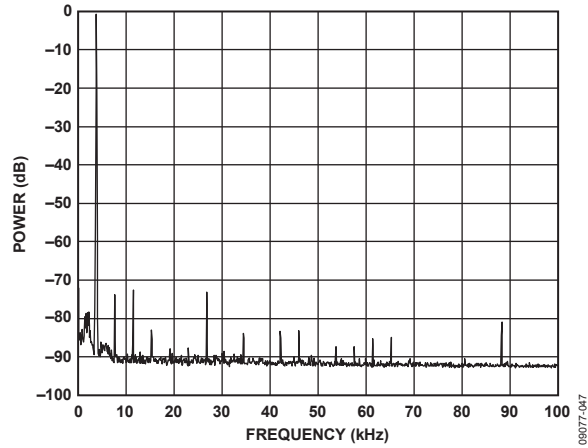

Figure 15. Power vs. Frequency,  $f_{MCLK} = 16$  MHz,  $f_{OUT} = 3.8$  kHz, Frequency Word = 0x000FBA9

09077-047

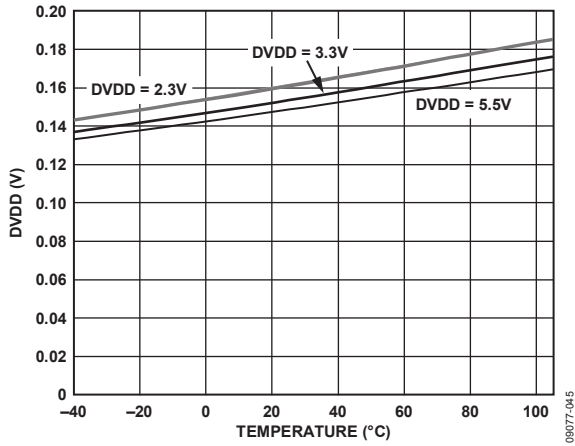

Figure 13. SIGN BIT OUT Pin, Low Level,  $I_{SINK} = 1$  mA

09077-045

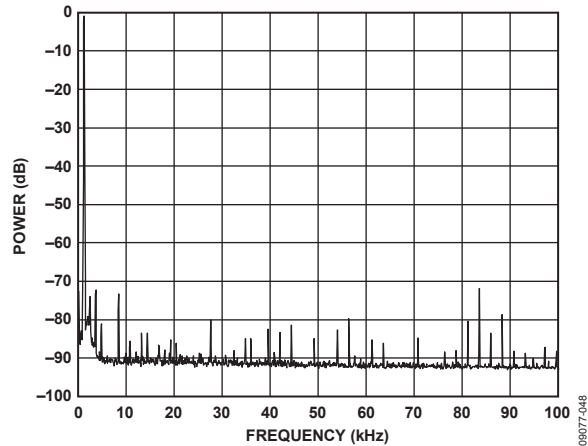

Figure 16. Power vs. Frequency,  $f_{MCLK} = 5$  MHz,  $f_{OUT} = 1.2$  kHz, Frequency Word = 0x000FBA9

09077-048

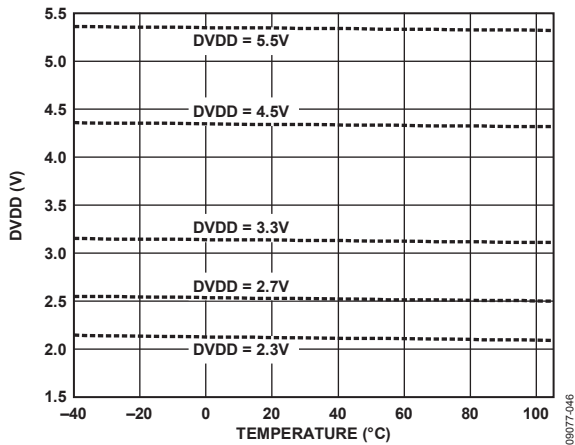

Figure 14. SIGN BIT OUT Pin, High Level,  $I_{SINK} = 1$  mA

09077-046

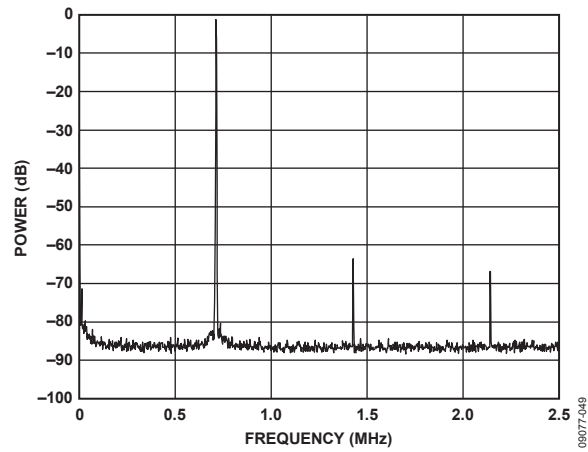

Figure 17. Power vs. Frequency,  $f_{MCLK} = 5$  MHz,  $f_{OUT} = 0.714$  MHz =  $f_{MCLK}/7$ , Frequency Word = 0x2492492

09077-049

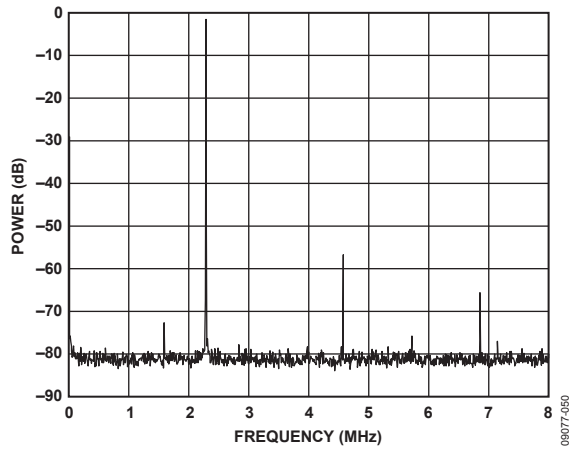

Figure 18. Power vs. Frequency,  $f_{MCLK} = 16$  MHz,  $f_{OUT} = 2.28$  MHz, Frequency Word = 0x2492492

# AD9838

## TEST CIRCUIT

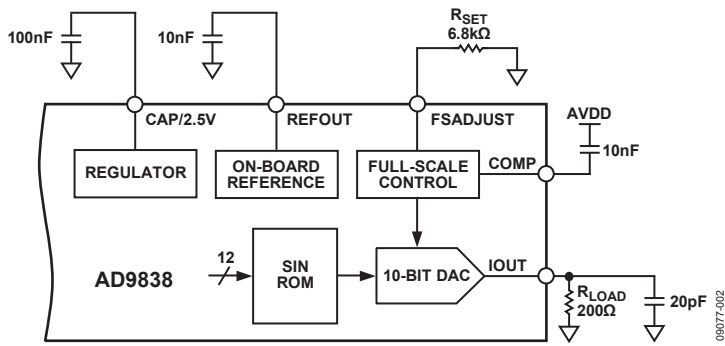

Figure 19. Test Circuit Used to Test Specifications

096377-002

## TERMINOLOGY

### Integral Nonlinearity (INL)

INL is the maximum deviation of any code from a straight line passing through the endpoints of the transfer function. The endpoints of the transfer function are zero scale, a point 0.5 LSB below the first code transition (000 ... 00 to 000 ... 01), and full scale, a point 0.5 LSB above the last code transition (111 ... 10 to 111 ... 11). The error is expressed in LSBs.

### Differential Nonlinearity (DNL)

DNL is the difference between the measured and ideal 1 LSB change between two adjacent codes in the DAC. A specified DNL of  $\pm 1$  LSB maximum ensures monotonicity.

### Output Compliance

Output compliance refers to the maximum voltage that can be generated at the output of the DAC to meet the specifications. When voltages greater than that specified for the output compliance are generated, the AD9838 may not meet the specifications listed in the data sheet.

### Spurious-Free Dynamic Range (SFDR)

Along with the frequency of interest, harmonics of the fundamental frequency and images of these frequencies are present at the output of a DDS device. The spurious-free dynamic range (SFDR) refers to the largest spur or harmonic present in the band of interest. The wideband SFDR gives the magnitude of the largest spur or harmonic relative to the magnitude of the fundamental frequency in the 0 to Nyquist bandwidth. The narrow-band SFDR gives the attenuation of the largest spur or harmonic in a bandwidth of  $\pm 200$  kHz about the fundamental frequency.

### Total Harmonic Distortion (THD)

Total harmonic distortion (THD) is the ratio of the rms sum of harmonics to the rms value of the fundamental. For the AD9838, THD is defined as

$$THD = 20 \log \sqrt{\frac{V_2^2 + V_3^2 + V_4^2 + V_5^2 + V_6^2}{V_1^2}}$$

where:

$V_1$  is the rms amplitude of the fundamental.

$V_2, V_3, V_4, V_5,$  and  $V_6$  are the rms amplitudes of the second through sixth harmonics.

### Signal-to-Noise Ratio (SNR)

SNR is the ratio of the rms value of the measured output signal to the rms sum of all other spectral components below the Nyquist frequency. The value for SNR is expressed in decibels.

### Clock Feedthrough

There is feedthrough from the MCLK input to the analog output. Clock feedthrough refers to the magnitude of the MCLK signal relative to the fundamental frequency in the output spectrum of the AD9838.

## THEORY OF OPERATION

Sine waves are typically thought of in terms of their magnitude form:  $a(t) = \sin(\omega t)$ . However, sine waves are nonlinear and not easy to generate except through piecewise construction. On the other hand, the angular information is linear in nature; that is, the phase angle rotates through a fixed angle for each unit of time. The angular rate depends on the frequency of the signal by the traditional rate of  $\omega = 2\pi f$ .

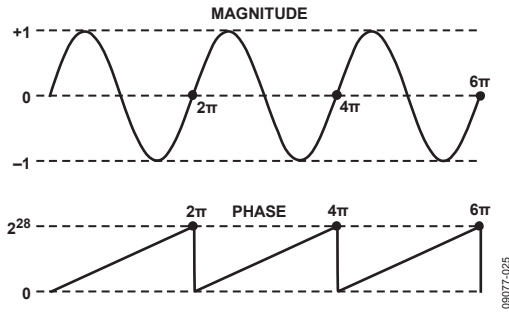

Figure 20. Sine Wave

Knowing that the phase of a sine wave is linear and given a reference interval (clock period), the phase rotation for that period can be determined as follows:

$$\Delta Phase = \omega \Delta t \tag{1}$$

Solving for  $\omega$ ,

$$\omega = \Delta Phase / \Delta t = 2\pi f \tag{2}$$

Solving for  $f$  and substituting the reference clock frequency for the reference period ( $1/f_{MCLK} = \Delta t$ ),

$$f = \Delta Phase \times f_{MCLK} / 2\pi \tag{3}$$

The AD9838 builds the output based on this simple equation. A simple DDS chip can implement this equation with three major subcircuits: numerically controlled oscillator (NCO) plus phase modulator, SIN ROM, and digital-to-analog converter (DAC). Each subcircuit is described in the Circuit Description section.

## CIRCUIT DESCRIPTION

The AD9838 is a fully integrated direct digital synthesis (DDS) chip. The chip requires one reference clock, one low precision resistor, and eight decoupling capacitors to provide digitally created sine waves up to 8 MHz. In addition to the generation of this RF signal, the chip is fully capable of a broad range of simple and complex modulation schemes. These modulation schemes are fully implemented in the digital domain, allowing accurate and simple realization of complex modulation algorithms using DSP techniques.

The internal circuitry of the AD9838 consists of the following main sections: a numerically controlled oscillator (NCO), frequency and phase modulators, SIN ROM, a digital-to-analog converter, a comparator, and a regulator.

### NUMERICALLY CONTROLLED OSCILLATOR PLUS PHASE MODULATOR

The AD9838 consists of two frequency select registers, a phase accumulator, two phase offset registers, and a phase offset adder. The main component of the NCO is a 28-bit phase accumulator. Continuous time signals have a phase range of 0 to  $2\pi$ . Outside this range of numbers, the sinusoid functions repeat themselves in a periodic manner. The digital implementation is no different. The accumulator simply scales the range of phase numbers into a multibit digital word. The phase accumulator in the AD9838 is implemented with 28 bits. Therefore, in the AD9838,  $2\pi = 2^{28}$ . Likewise, the  $\Delta\text{Phase}$  term is scaled into this range of numbers:

$$0 < \Delta\text{Phase} < 2^{28} - 1$$

With these substitutions, Equation 3 becomes

$$f = \Delta\text{Phase} \times f_{\text{MCLK}} / 2^{28} \quad (4)$$

where  $0 < \Delta\text{Phase} < 2^{28} - 1$ .

The input to the phase accumulator can be selected from either the FREQ0 register or the FREQ1 register and is controlled by the FSELECT pin or the FSEL bit in the control register. NCOs inherently generate continuous phase signals, thus avoiding any output discontinuity when switching between frequencies.

Following the NCO, a phase offset can be added to perform phase modulation using the 12-bit phase registers. The contents of one of these phase registers is added to the MSBs of the NCO. The AD9838 has two phase registers; their resolution is  $2\pi/4096$ .

### SIN ROM

To make the output from the NCO useful, it must be converted from phase information into a sinusoidal value. Because phase information maps directly to amplitude, the SIN ROM uses the digital phase information as an address to a lookup table and converts the phase information into amplitude.

Although the NCO contains a 28-bit phase accumulator, the output of the NCO is truncated to 12 bits. Using the full resolution of the phase accumulator is impractical and unnecessary because a lookup table of  $2^{28}$  entries would be required. It is only necessary to have sufficient phase resolution such that the errors due to truncation are smaller than the resolution of the 10-bit DAC. Therefore, the SIN ROM must have two bits of phase resolution more than the 10-bit DAC.

The SIN ROM is enabled using the OPBITEN and MODE bits (Bit D5 and Bit D1) in the control register (see Table 19).

### DIGITAL-TO-ANALOG CONVERTER (DAC)

The AD9838 includes a high impedance, current source, 10-bit DAC capable of driving a wide range of loads. The full-scale output current can be adjusted for optimum power and external load requirements using a single external resistor ( $R_{\text{SET}}$ ).

The DAC can be configured for single-ended or differential operation. The IOUT and IOUTB pins can be connected through equal external resistors to AGND to develop complementary output voltages. The load resistors can be of any value required, as long as the full-scale voltage developed across them does not exceed the output compliance range. Because full-scale current is controlled by  $R_{\text{SET}}$ , adjustments to  $R_{\text{SET}}$  can balance changes made to the load resistors.

### COMPARATOR

The AD9838 can be used to generate synthesized digital clock signals. This is accomplished by using the on-board self-biasing comparator that converts the sinusoidal signal of the DAC to a square wave. The output from the DAC can be filtered externally before being applied to the comparator input. The comparator reference voltage is the time average of the signal applied to VIN. The comparator can accept signals in the range of approximately 100 mV p-p to 1 V p-p. The comparator input is ac-coupled; therefore, to operate correctly as a zero-crossing detector, the comparator requires a minimum input frequency of 3 MHz typical. The comparator output is a square wave with an amplitude from 0 V to DVDD.

The AD9838 provides a sampled signal with its output following Nyquist sampling theorem. Specifically, its output spectrum contains the fundamental plus aliased signals (images) that occur at multiples of the reference clock frequency and the selected output frequency. A graphical representation of the sampled spectrum, with aliased images, is shown in Figure 21.

The prominence of the aliased images depends on the ratio of  $f_{OUT}$  to MCLK. If the ratio is small, the aliased images are very prominent and of a relatively high energy level as determined by the  $\sin(x)/x$  roll-off of the quantized DAC output. In fact, depending on the  $f_{OUT}$ /reference clock ratio, the first aliased image can be on the order of  $-3$  dB below the fundamental.

A low-pass filter is generally placed between the output of the DAC and the input of the comparator to further suppress the effects of aliased images. To avoid unwanted (and unexpected) output anomalies, it is necessary to consider the relationship of the selected output frequency and the reference clock frequency.

To apply the AD9838 as a clock generator, limit the selected output frequency to  $<33\%$  of the reference clock frequency. In this way, the user can prevent the generation of aliased signals that fall within, or close to, the output band of interest (generally the dc selected output frequency). This practice reduces the complexity (and cost) of the external filter requirement for the clock generator application. For more information, see the [AN-837 Application Note](#).

To enable the comparator, the SIGN/PIB and OPBITEN bits in the control register must be set to 1 (see Table 18).

## REGULATOR

The AD9838 has separate power supplies for the analog and digital sections. AVDD provides the power supply required for the analog section, and DVDD provides the power supply for the digital section. Both supplies can have a value of 2.3 V to 5.5 V and are independent of each other. For example, the analog section can be operated at 5 V, and the digital section can be operated at 3 V, or vice versa.

The internal digital section of the AD9838 is operated at 2.5 V. An on-board regulator steps down the voltage applied at DVDD to 2.5 V. The digital interface (serial port) of the AD9838 also operates from DVDD. These digital signals are level shifted within the AD9838 to make them 2.5 V compatible.

If the voltage applied at the DVDD pin of the AD9838 is less than or equal to 2.7 V, the CAP/2.5V and DVDD pins should be tied together to bypass the on-board regulator.

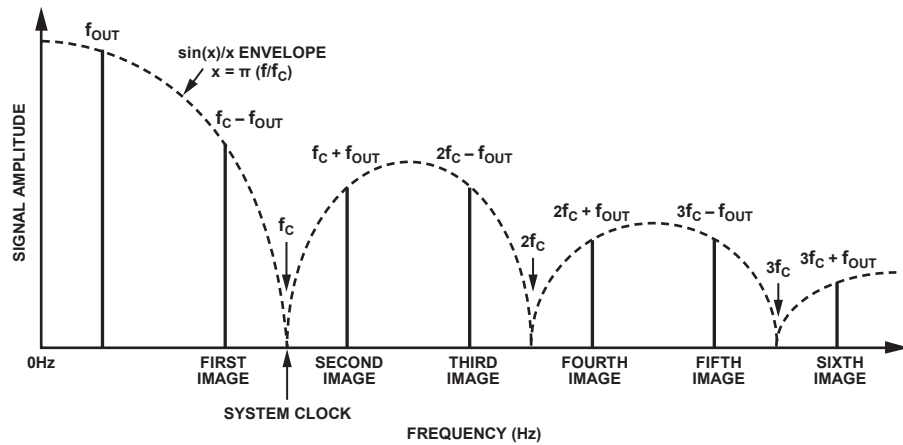

Figure 21. DAC Output Spectrum

06077-040



# FUNCTIONAL DESCRIPTION

## SERIAL INTERFACE

The AD9838 has a standard 3-wire serial interface that is compatible with the SPI, QSPI™, MICROWIRE®, and DSP interface standards.

Data is loaded into the device as a 16-bit word under the control of a serial clock input, SCLK. The timing diagram for this operation is given in Figure 4.

FSYNC is a level triggered input that acts as a frame synchronization and chip enable input. Data can be transferred into the device only when FSYNC is low. To start the serial data transfer, FSYNC should be taken low, observing the minimum FSYNC to SCLK falling edge setup time,  $t_7$  (see Table 2). After FSYNC goes low, serial data is shifted into the input shift register of the device on the falling edges of SCLK for 16 clock pulses. FSYNC can be taken high after the 16th falling edge of SCLK, observing the minimum SCLK falling edge to FSYNC rising edge time,  $t_8$ . Alternatively, FSYNC can be kept low for a multiple of 16 SCLK pulses and then brought high at the end of the data transfer. In this way, a continuous stream of 16-bit words can be loaded while FSYNC is held low; FSYNC goes high only after the 16th SCLK falling edge of the last word loaded.

The SCLK can be continuous, or it can idle high or low between write operations. In either case, it must be high when FSYNC goes low ( $t_{12}$ ).

For an example of how to program the AD9838, see the [AN-1070 Application Note](#) on the Analog Devices, Inc., website. The AD9838 has the same register settings as the [AD9833/AD9834](#).

## LATENCY PERIOD

A latency period is associated with each operation. When the FSELECT and PSELECT pins change value, there is a pipeline delay before control is transferred to the selected register.

When the  $t_{11}$  and  $t_{11A}$  timing specifications are met (see Figure 3), FSELECT and PSELECT have latencies of eight MCLK cycles. When the  $t_{11}$  and  $t_{11A}$  timing specifications are not met, the latency is increased by one MCLK cycle.

Similarly, a latency period is associated with each asynchronous write operation. If a selected frequency or phase register is loaded with a new word, there is a delay of eight or nine MCLK cycles before the analog output changes. The delay can be eight or nine MCLK cycles, depending on the position of the MCLK rising edge when the data is loaded into the destination register.

The negative transitions of the RESET and SLEEP pins are sampled on the internal falling edge of MCLK. Therefore, they also have a latency period associated with them.

## CONTROL REGISTER

The AD9838 contains a 16-bit control register that allows the user to configure the operation of the AD9838. All control bits other than the MODE bit are sampled on the internal falling edge of MCLK.

Figure 22 illustrates the functions of the control bits. Table 7 describes the individual bits of the control register. The different functions and the various output options of the AD9838 are described in more detail in the following sections.

To inform the AD9838 that the contents of the control register will be altered, Bit D15 and Bit D14 must be set to 0, as shown in Table 6.

**Table 6. Control Register Bits**

| D15 | D14 | D13 to D0    |
|-----|-----|--------------|
| 0   | 0   | Control bits |

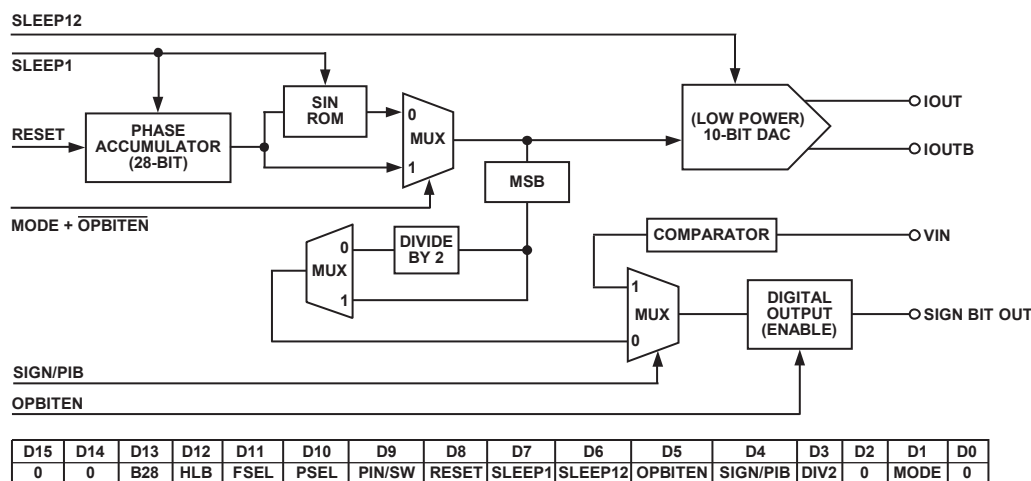

Figure 22. Function of Control Bits

Table 7. Control Register Bit Descriptions

| Bit | Bit Name | Description   |
|-----|----------|---|
| D13 | B28      | Two write operations are required to load a complete word into either of the frequency registers.<br>B28 = 1 allows a complete word to be loaded into a frequency register in two consecutive writes. The first write contains the 14 LSBs of the frequency word, and the second write contains the 14 MSBs. The first two bits of each 16-bit word define the frequency register to which the word is loaded and should, therefore, be the same for both consecutive writes. See Table 11 for the appropriate addresses. The write to the frequency register occurs after both words have been loaded, so the register never holds an intermediate value. An example of a complete 28-bit write is shown in Table 12. Note, however, that consecutive 28-bit writes to the same frequency register are not allowed; to execute consecutive 28-bit writes, you must alternate between the frequency registers.<br>B28 = 0 configures the 28-bit frequency register to operate as two 14-bit registers, one containing the 14 MSBs and the other containing the 14 LSBs. In this way, the 14 MSBs of the frequency word can be altered independently of the 14 LSBs, and vice versa. To alter the 14 MSBs or the 14 LSBs, a single write is made to the appropriate frequency address. Bit D12 (HLB) informs the AD9838 whether the bits to be altered are the 14 MSBs or the 14 LSBs. |
| D12 | HLB      | This control bit allows the user to continuously load the MSBs or LSBs of a frequency register while ignoring the remaining 14 bits. This is useful if the complete 28-bit resolution is not required. The HLB bit is used in conjunction with the B28 bit (Bit D13). The HLB bit indicates whether the 14 bits to be loaded are transferred to the 14 MSBs or the 14 LSBs of the addressed frequency register. Bit D13 (B28) must be set to 0 to change the MSBs or LSBs of a frequency word separately. When Bit D13 (B28) is set to 1, the HLB bit is ignored.<br>HLB = 1 allows a write to the 14 MSBs of the addressed frequency register.<br>HLB = 0 allows a write to the 14 LSBs of the addressed frequency register.   |
| D11 | FSEL     | The FSEL bit defines whether the FREQ0 register or the FREQ1 register is used in the phase accumulator (see Table 9).   |
| D10 | PSEL     | The PSEL bit defines whether the PHASE0 register data or the PHASE1 register data is added to the output of the phase accumulator (see Table 10).   |
| D9  | PIN/SW   | The following functions can be implemented using either software or hardware: frequency register selection, phase register selection, reset of internal registers, and DAC power-down. The PIN/SW bit selects the source of control for these functions.<br>PIN/SW = 1 selects the control pins to implement the register selection, reset, and DAC power-down functions.<br>PIN/SW = 0 selects the control bits to implement the register selection, reset, and DAC power-down functions.  |
| D8  | RESET    | When the PIN/SW bit is set to 0, this bit controls the reset function.<br>RESET = 1 resets internal registers to 0, which corresponds to an analog output of midscale.<br>RESET = 0 disables the reset function (see the Reset Function section).   |
| D7  | SLEEP1   | This bit enables or disables the internal MCLK.<br>SLEEP1 = 1 disables the internal MCLK. The DAC output remains at its present value because the NCO is no longer accumulating.<br>SLEEP1 = 0 enables the internal MCLK (see the Sleep Function section).  |
| D6  | SLEEP12  | When the PIN/SW bit is set to 0, this bit powers down the on-chip DAC.<br>SLEEP12 = 1 powers down the on-chip DAC. This is useful when the AD9838 is used to output the MSB of the DAC data.<br>SLEEP12 = 0 implies that the DAC is active (see the Sleep Function section).  |
| D5  | OPBITEN  | This bit controls whether an output is available at the SIGN BIT OUT pin. If the user is not using the SIGN BIT OUT pin, this bit should be set to 0.<br>OPBITEN = 1 enables the SIGN BIT OUT pin.<br>OPBITEN = 0 places the SIGN BIT OUT output buffer into a high impedance state (no output is available at the SIGN BIT OUT pin).   |
| D4  | SIGN/PIB | This bit controls the output at the SIGN BIT OUT pin when the OPBITEN bit (Bit D5) is set to 1.<br>SIGN/PIB = 1 connects the on-board comparator to the SIGN BIT OUT pin. After filtering the sinusoidal output from the DAC, the waveform can be applied to the comparator to generate a square waveform (see Table 18).<br>SIGN/PIB = 0 connects the MSB (or MSB/2) of the DAC data to the SIGN BIT OUT pin. Bit D3 (DIV2) controls whether the output is the MSB or MSB/2.   |
| D3  | DIV2     | DIV2 is used when the OPBITEN bit (Bit D5) is set to 1 and the SIGN/PIB bit (Bit D4) is set to 0 (see Table 18).<br>DIV2 = 1 causes the MSB of the DAC data to be output at the SIGN BIT OUT pin.<br>DIV2 = 0 causes the MSB/2 of the DAC data to be output at the SIGN BIT OUT pin.  |
| D2  | Reserved | This bit must be set to 0.  |
| D1  | MODE     | This bit, in association with the OPBITEN bit (Bit D5), controls the output at the IOUT and IOUTB pins. This bit should be set to 0 if the OPBITEN bit is set to 1 (see Table 19).<br>MODE = 1 bypasses the SIN ROM, resulting in a triangle output from the DAC.<br>MODE = 0 uses the SIN ROM to convert the phase information into amplitude information, resulting in a sinusoidal signal at the output.   |
| D0  | Reserved | This bit must be set to 0.  |

## FREQUENCY AND PHASE REGISTERS

The AD9838 contains two frequency registers and two phase registers, which are described in Table 8.

**Table 8. Frequency and Phase Registers**

| Register | Size    | Description   |
|----------|---------|---|
| FREQ0    | 28 bits | Frequency Register 0.<br>When the FSEL bit or FSELECT pin = 0, the FREQ0 register defines the output frequency as a fraction of the MCLK frequency.     |
| FREQ1    | 28 bits | Frequency Register 1.<br>When the FSEL bit or FSELECT pin = 1, the FREQ1 register defines the output frequency as a fraction of the MCLK frequency.     |
| PHASE0   | 12 bits | Phase Offset Register 0.<br>When the PSEL bit or PSELECT pin = 0, the contents of the PHASE0 register are added to the output of the phase accumulator. |
| PHASE1   | 12 bits | Phase Offset Register 1.<br>When the PSEL bit or PSELECT pin = 1, the contents of the PHASE1 register are added to the output of the phase accumulator. |

The analog output from the AD9838 is

$$f_{MCLK}/2^{28} \times FREQREG$$

where *FREQREG* is the value loaded into the selected frequency register.

This signal is phase shifted by

$$2\pi/4096 \times PHASEREG$$

where *PHASEREG* is the value contained in the selected phase register.

The relationship of the selected output frequency and the reference clock frequency must be considered to avoid unwanted output anomalies.

### Selecting a Frequency or Phase Register

Access to the frequency and phase registers is controlled by the FSELECT and PSELECT pins or by the FSEL and PSEL control bits. If the PIN/SW control bit (Bit D9) = 1, the pins control the function; if the PIN/SW control bit = 0, the bits control the function (see Table 9 and Table 10). If the FSEL and PSEL bits are used, the pins should be held at CMOS logic high or low. Control of the frequency and phase registers is interchangeable from the pins to the bits.

**Table 9. Selecting a Frequency Register**

| FSELECT Pin | FSEL Bit | PIN/SW Bit | Selected Register |
|-------------|----------|------------|-------------------|
| 0           | X        | 1          | FREQ0             |
| 1           | X        | 1          | FREQ1             |
| X           | 0        | 0          | FREQ0             |
| X           | 1        | 0          | FREQ1             |

**Table 10. Selecting a Phase Register**

| PSELECT Pin | PSEL Bit | PIN/SW Bit | Selected Register |
|-------------|----------|------------|-------------------|
| 0           | X        | 1          | PHASE0            |
| 1           | X        | 1          | PHASE1            |
| X           | 0        | 0          | PHASE0            |
| X           | 1        | 0          | PHASE1            |

The FSELECT and PSELECT pins are sampled on the internal falling edge of MCLK. It is recommended that the data on these pins not change within the time window of the falling edge of MCLK (see Figure 3 for timing). If the FSELECT or PSELECT pin changes value when a falling edge occurs, there is an uncertainty of one MCLK cycle as it pertains to when control is transferred to the other frequency/phase register.

The flowcharts in Figure 26 and Figure 27 show the routine for selecting and writing to the frequency and phase registers of the AD9838.

### Writing to a Frequency Register

When writing to a frequency register, Bit D15 and Bit D14 of the control register give the address of the frequency register (see Table 11).

**Table 11. Frequency Register Bits**

| D15 | D14 | D13 to D0              |
|-----|-----|------------------------|
| 0   | 1   | 14 FREQ0 register bits |
| 1   | 0   | 14 FREQ1 register bits |

To change the entire contents of a frequency register, two consecutive writes to the same address must be performed because the frequency registers are 28 bits wide. The first write contains the 14 LSBs, and the second write contains the 14 MSBs. For this mode of operation, the B28 control bit (Bit D13) must be set to 1. An example of a 28-bit write is shown in Table 12.

**Table 12. Writing 0xFFFC000 to the FREQ0 Register**

| SDATA Input         | Result of Input Word   |
|---------------------|--|
| 0010 0000 0000 0000 | Control word write<br>(D15, D14 = 00), B28 (D13) = 1,<br>HLB (D12) = X |
| 0100 0000 0000 0000 | FREQ0 register write<br>(D15, D14 = 01), 14 LSBs = 0x0000              |
| 0111 1111 1111 1111 | FREQ0 register write<br>(D15, D14 = 01), 14 MSBs = 0x3FFF              |

Note, however, that continuous writes to the same frequency register may result in intermediate updates during the writes. If a frequency sweep, or something similar, is required, it is recommended that users alternate between the two frequency registers.

# AD9838

In some applications, the user does not need to alter all 28 bits of the frequency register. With coarse tuning, only the 14 MSBs are altered; with fine tuning, only the 14 LSBs are altered. By setting the B28 control bit (Bit D13) to 0, the 28-bit frequency register operates as two 14-bit registers, one containing the 14 MSBs and the other containing the 14 LSBs. In this way, the 14 MSBs of the frequency word can be altered independently of the 14 LSBs, and vice versa. The HLB bit (Bit D12) in the control register identifies which 14 bits are being altered (see Table 13 and Table 14).

**Table 13. Writing 0x3FFF to the 14 LSBs of the FREQ1 Register**

| SDATA Input         | Result of Input Word  |
|---------------------|---|
| 0000 0000 0000 0000 | Control word write (D15, D14 = 00), B28 (D13) = 0, HLB (D12) = 0, that is, LSBs |
| 1011 1111 1111 1111 | FREQ1 register write (D15, D14 = 10), 14 LSBs = 0x3FFF                          |

**Table 14. Writing 0x00FF to the 14 MSBs of the FREQ0 Register**

| SDATA Input         | Result of Input Word  |
|---------------------|---|
| 0001 0000 0000 0000 | Control word write (D15, D14 = 00), B28 (D13) = 0, HLB (D12) = 1, that is, MSBs |
| 0100 0000 1111 1111 | FREQ0 register write (D15, D14 = 01), 14 MSBs = 0x00FF                          |

## Writing to a Phase Register

When writing to a phase register, Bit D15 and Bit D14 are set to 11. Bit D13 identifies the phase register that is being loaded.

**Table 15. Phase Register Bits**

| D15 | D14 | D13 | D12 | D11 to D0               |
|-----|-----|-----|-----|-------------------------|
| 1   | 1   | 0   | X   | 12 PHASE0 register bits |
| 1   | 1   | 1   | X   | 12 PHASE1 register bits |

## RESET FUNCTION

The reset function resets the appropriate internal registers to 0 to provide an analog output of midscale. A reset does not reset the phase, frequency, or control registers. When the AD9838 is powered up, the part should be reset (see the Powering Up the AD9838 section). To reset the AD9838, set the RESET pin or bit to 1. To take the part out of reset, set the RESET pin or bit to 0. A signal appears at the DAC output eight or nine MCLK cycles after the RESET pin or bit is set to 0.

The reset function is controlled by either the RESET pin or the RESET control bit. If the PIN/SW control bit = 0, the RESET bit controls the function; if the PIN/SW control bit = 1, the RESET pin controls the function (see Table 16).

**Table 16. Applying the Reset Function**

| RESET Pin | RESET Bit | PIN/SW Bit | Result                   |
|-----------|-----------|------------|--------------------------|
| 0         | X         | 1          | No reset applied         |
| 1         | X         | 1          | Internal registers reset |
| X         | 0         | 0          | No reset applied         |
| X         | 1         | 0          | Internal registers reset |

The effect of asserting the RESET pin is immediately evident at the output—that is, the 0-to-1 transition of this pin is not sampled. However, the negative (1-to-0) transition of the RESET pin is sampled on the internal falling edge of MCLK.

## SLEEP FUNCTION

Sections of the AD9838 that are not in use can be powered down to minimize power consumption by using the sleep function. The parts of the chip that can be powered down are the internal clock and the DAC. The DAC can be powered down using hardware or software (see Table 17).

**Table 17. Applying the Sleep Function**

| SLEEP Pin | SLEEP1 Bit | SLEEP12 Bit | PIN/SW Bit | Result                                       |
|-----------|------------|-------------|------------|--|
| 0         | X          | X           | 1          | No power-down                                |
| 1         | X          | X           | 1          | DAC powered down                             |
| X         | 0          | 0           | 0          | No power-down                                |
| X         | 0          | 1           | 0          | DAC powered down                             |
| X         | 1          | 0           | 0          | Internal clock disabled                      |
| X         | 1          | 1           | 0          | DAC powered down and internal clock disabled |

### DAC Powered Down

When the AD9838 is used to output the MSB of the DAC data only, the DAC is not required. The DAC can be powered down to reduce power consumption.

### Internal Clock Disabled

When the internal clock of the AD9838 is disabled, the DAC output remains at its present value because the NCO is no longer accumulating. New frequency, phase, and control words can be written to the part when the SLEEP1 control bit is active. Because the synchronizing clock (FSYNC) remains active, the selected frequency and phase registers can also be changed either at the pins or by using the control bits. Setting the SLEEP1 bit to 0 enables the MCLK. Any changes made to the registers while SLEEP1 was active are observed at the output after a latency period (see the Latency Period section).

The effect of asserting the SLEEP pin is immediately evident at the output—that is, the 0-to-1 transition of this pin is not sampled. However, the negative (1-to-0) transition of the SLEEP pin is sampled on the internal falling edge of MCLK.

## SIGN BIT OUT PIN

The AD9838 offers a variety of outputs from the chip. The digital outputs are available from the SIGN BIT OUT pin. The available outputs are the comparator output or the MSB of the DAC data. The bits controlling the SIGN BIT OUT pin are listed in Table 18.

**Table 18. Outputs from the SIGN BIT OUT Pin**

| OPBITEN Bit | MODE Bit | SIGN/PIB Bit | DIV2 Bit | SIGN BIT OUT Pin  |
|-------------|----------|--------------|----------|-------------------|
| 0           | X        | X            | X        | High impedance    |
| 1           | 0        | 0            | 0        | DAC data MSB/2    |
| 1           | 0        | 0            | 1        | DAC data MSB      |
| 1           | 0        | 1            | 0        | Reserved          |
| 1           | 0        | 1            | 1        | Comparator output |
| 1           | 1        | X            | X        | Reserved          |

The SIGN BIT OUT pin must be enabled before use. The OPBITEN bit (Bit D5) in the control register enables and disables this pin. When OPBITEN = 1, the SIGN BIT OUT pin is enabled. Note that if OPBITEN = 1, the MODE bit (Bit D1) in the control register should be set to 0.

### Comparator Output

The AD9838 has an on-board comparator. To connect this comparator to the SIGN BIT OUT pin, the OPBITEN bit (Bit D5) and the SIGN/PIB bit (Bit D4) must be set to 1. After filtering the sinusoidal output from the DAC, the waveform can be applied to the comparator to generate a square waveform.

### MSB of the DAC Data

The MSB of the DAC data can be output from the AD9838. By setting the OPBITEN bit (Bit D5) to 1 and the SIGN/PIB bit (Bit D4) to 0, the MSB of the DAC data is available at the SIGN BIT OUT pin. This output is useful as a coarse clock source. The square wave can also be divided by 2 before being output. The DIV2 bit (Bit D3) in the control register controls the frequency of this output from the SIGN BIT OUT pin.

## IOUT AND IOUTB PINS

The analog outputs from the AD9838 are available from the IOUT and IOUTB pins. The available outputs are a sinusoidal output or a triangular output (see Table 19).

Note that the SLEEP pin and the SLEEP12 bit must be set to 0 (the DAC is enabled) when using the IOUT and IOUTB pins.

**Table 19. Outputs from the IOUT and IOUTB Pins**

| OPBITEN Bit | MODE Bit | IOUT and IOUTB Pin Output |
|-------------|----------|---------------------------|
| 0           | 0        | Sinusoid                  |
| 0           | 1        | Triangle                  |
| 1           | 0        | Sinusoid                  |
| 1           | 1        | Reserved                  |

### Sinusoidal Output

The SIN ROM converts the phase information from the frequency and phase registers into amplitude information, resulting in a sinusoidal signal at the output. To obtain a sinusoidal output from the IOUT and IOUTB pins, set the MODE bit (Bit D1) to 0.

### Triangle Output

The SIN ROM can be bypassed so that the truncated digital output from the NCO is sent to the DAC. In this case, the output is no longer sinusoidal. The DAC produces a 10-bit linear triangular function (see Figure 23). To obtain a triangle output from the IOUT and IOUTB pins, set the MODE bit (Bit D1) to 1 and the OPBITEN bit (Bit D5) to 0.

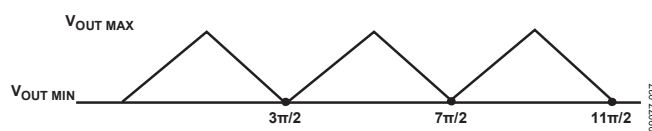

Figure 23. Triangle Output

## POWERING UP THE AD9838

The flowchart in Figure 24 shows the operating routine for the AD9838. When the AD9838 is powered up, the part should be reset. This resets the appropriate internal registers to 0 to provide an analog output of midscale. To avoid spurious DAC outputs during AD9838 initialization, the RESET pin or the RESET bit should be set to 1 until the part is ready to begin generating an output.

A reset does not reset the phase, frequency, or control registers. These registers will contain invalid data and, therefore, should be set to known values by the user. The RESET pin or bit should then be set to 0 to begin generating an output. The data appears on the DAC output eight or nine MCLK cycles after the RESET pin or bit is set to 0.

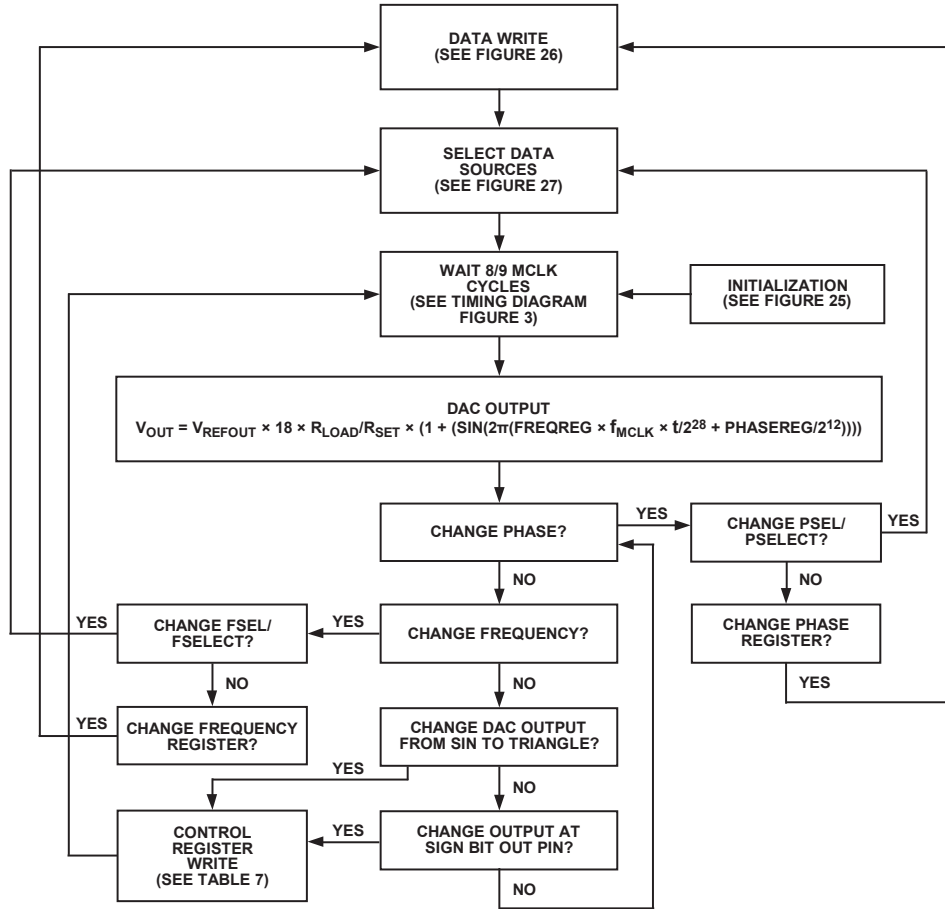

Figure 24. Flowchart for AD9838 Initialization and Operation

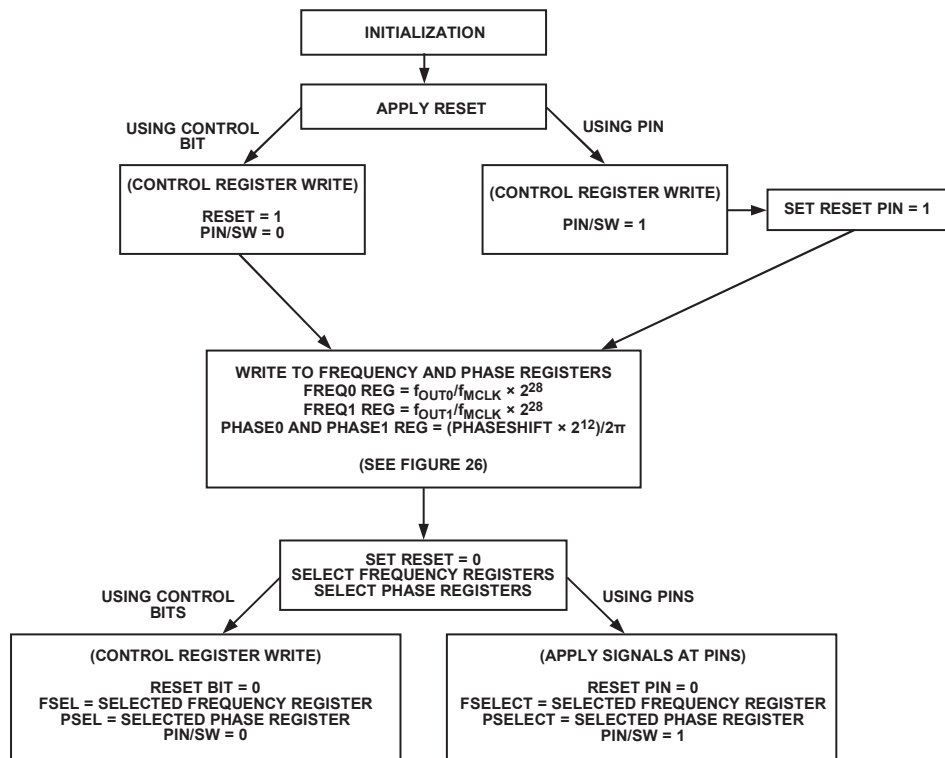

Figure 25. Flowchart for Initialization

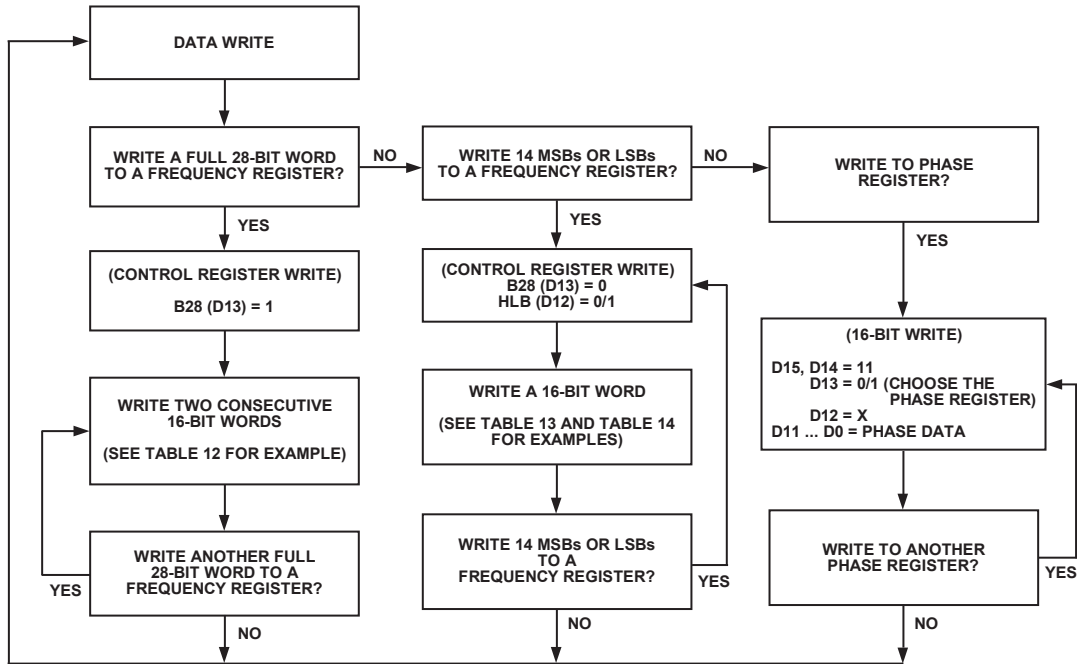

Figure 26. Flowchart for Data Writes

08077-030

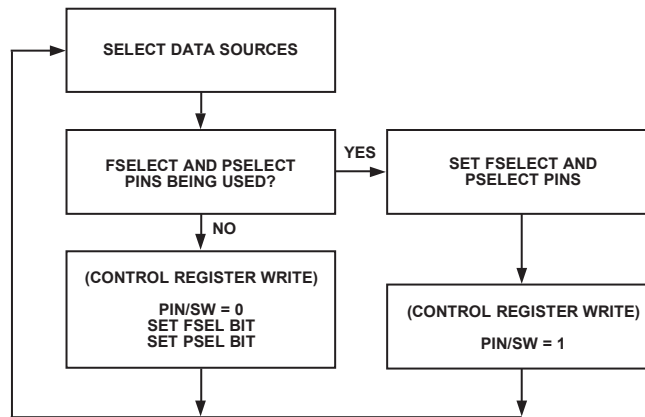

Figure 27. Flowchart for Selecting Data Sources

08077-031

## APPLICATIONS INFORMATION

The various output options available from the AD9838 make the part suitable for a wide variety of applications, including modulation applications. The AD9838 can be used to perform simple modulation, such as frequency shift keying (FSK). More complex modulation schemes, such as Gaussian minimum shift keying (GMSK) and quadrature phase shift keying (QPSK), can also be implemented using the AD9838.

In an FSK application, the two frequency registers of the AD9838 are loaded with different values. One frequency represents the space frequency, and the other represents the mark frequency. The digital data stream is fed to the FSELECT pin, causing the AD9838 to modulate the carrier frequency between the two values.

The AD9838 has two phase registers, enabling the part to perform phase shift keying (PSK). With PSK, the carrier frequency is phase shifted, that is, the phase is altered by an amount that is related to the bit stream input to the modulator.

The AD9838 is also suitable for signal generator applications. Using the on-board comparator, the device can be used to generate a square wave.

With its low current consumption, the part is also suitable for applications in which it can be used as a local oscillator.

### GROUNDING AND LAYOUT

The printed circuit board that houses the AD9838 should be designed so that the analog and digital sections are separated and confined to certain areas of the board. This facilitates the use of ground planes that can be separated easily. A minimum etch technique is generally best for ground planes because it provides the best shielding. Digital and analog ground planes should be joined in one place only. If the AD9838 is the only device that requires an AGND to DGND connection, the ground planes should be connected at the AGND and DGND pins of the AD9838. If the AD9838 is in a system where multiple devices require AGND to DGND connections, the connection should be made at one point only, a star ground point that should be established as close as possible to the AD9838.

Avoid running digital lines under the device; these lines couple noise onto the die. The analog ground plane should be allowed to run under the AD9838 to avoid noise coupling. The power supply lines to the AD9838 should use as large a track as possible to provide low impedance paths and reduce the effects of glitches on the power supply line. Fast switching signals, such as clocks, should be shielded with digital ground to avoid radiating noise to other sections of the board.

Avoid crossover of digital and analog signals. Traces on opposite sides of the board should run at right angles to each other to reduce the effects of feedthrough through the board. A microstrip technique is by far the best but is not always possible with a double-sided board. In this technique, the component side of the board is dedicated to ground planes and signals are placed on the other side.

Good decoupling is important. The analog and digital supplies to the AD9838 are independent and separately pinned out to minimize coupling between the analog and digital sections of the device. All analog and digital supplies should be decoupled to AGND and DGND, respectively, with 0.1  $\mu$ F ceramic capacitors in parallel with 10  $\mu$ F tantalum capacitors. To achieve the best performance from the decoupling capacitors, they should be placed as close as possible to the device, ideally right up against the device.

In systems where a common supply is used to drive both the AVDD and DVDD pins of the AD9838, it is recommended that the system's AVDD supply be used. This supply should have the recommended analog supply decoupling between the AVDD pin of the AD9838 and AGND, as well as the recommended digital supply decoupling capacitors between the DVDD pin and DGND.

Proper operation of the comparator requires good layout strategy. The layout must minimize the parasitic capacitance between  $V_{IN}$  and the SIGN BIT OUT pin by using a ground plane to add isolation. For example, in a multilayered board, the  $V_{IN}$  signal can be connected to the top layer, and the SIGN BIT OUT pin can be connected to the bottom layer. In this way, isolation is provided by the power and ground planes between  $V_{IN}$  and the SIGN BIT OUT pin.

### INTERFACING TO MICROPROCESSORS

The AD9838 has a standard serial interface that allows the part to interface directly with several microprocessors. The device uses an external serial clock to write the data or control information into the device. The serial clock can have a frequency of 40 MHz maximum. The serial clock can be continuous, or it can idle high or low between write operations. When data or control information is written to the AD9838, FSYNC is taken low and is held low until the 16 bits of data are written into the AD9838. The FSYNC signal frames the 16 bits of information that are loaded into the AD9838.



### AD9838 to 68HC11/68L11 Interface

Figure 28 shows the serial interface between the AD9838 and the 68HC11/68L11 microcontroller. The microcontroller is configured as the master by setting the MSTR bit in the SPCR to 1. This setting provides a serial clock on SCK; the MOSI output drives the serial data line, SDATA. Because the microcontroller does not have a dedicated frame sync pin, the FSYNC signal is derived from a port line (PC7). The setup conditions for correct operation of the interface are as follows:

- SCK idles high between write operations (CPOL = 0)
- Data is valid on the SCK falling edge (CPHA = 1)

When data is to be transmitted to the AD9838, the FSYNC line (PC7) is taken low. Serial data from the 68HC11/68L11 is transmitted in 8-bit bytes with only eight falling clock edges occurring in the transmit cycle. Data is transmitted MSB first. To load data into the AD9838, PC7 is held low after the first eight bits are transferred, and a second serial write operation is performed to the AD9838. Only after the second eight bits are transferred should FSYNC be taken high again.

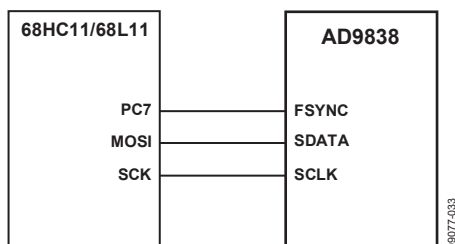

Figure 28. 68HC11/68L11 to AD9838 Interface

### AD9838 to 80C51/80L51 Interface

Figure 29 shows the serial interface between the AD9838 and the 80C51/80L51 microcontroller. The microcontroller is operated in Mode 0 so that TxD of the 80C51/80L51 drives SCLK of the AD9838, and RxD drives the serial data line, SDATA. The FSYNC signal is derived from a bit programmable pin on the port (P3.3 is shown in Figure 29).

When data is to be transmitted to the AD9838, P3.3 is taken low. The 80C51/80L51 transmits data in 8-bit bytes with only eight falling SCLK edges occurring in each cycle. To load the remaining eight bits to the AD9838, P3.3 is held low after the first eight bits are transmitted, and a second write operation is initiated to transmit the second byte of data. P3.3 is taken high following the completion of the second write operation. SCLK should idle high between the two write operations.

The 80C51/80L51 outputs the serial data in a format that has the LSB first. The AD9838 accepts the MSB first (the four MSBs are the control information, the next four bits are the address, and the eight LSBs contain the data when writing to a destination register). Therefore, the transmit routine of the 80C51/80L51 must take this into account and rearrange the bits so that the MSB is output first.

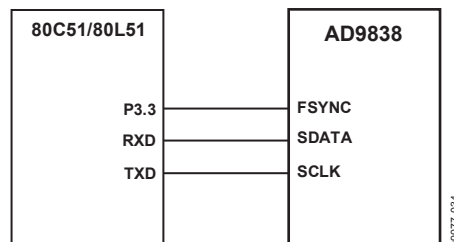

Figure 29. 80C51/80L51 to AD9838 Interface

### AD9838 to DSP56002 Interface

Figure 30 shows the interface between the AD9838 and the DSP56002. The DSP56002 is configured for normal mode asynchronous operation with a gated internal clock (SYN = 0, GCK = 1, SCKD = 1). The frame sync pin is generated internally (SC2 = 1), the transfers are 16 bits wide (WL1 = 1, WL0 = 0), and the frame sync signal frames the 16 bits (FSL = 0). The frame sync signal is available on the SC2 pin, but it must be inverted before it is applied to the AD9838. The interface to the DSP56000/DSP56001 is similar to that of the DSP56002.

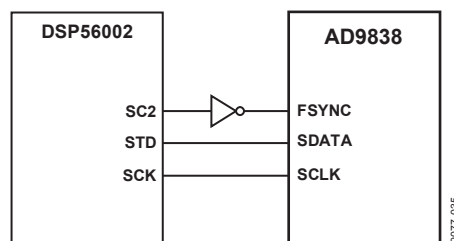

Figure 30. DSP56002 to AD9838 Interface

# AD9838

## EVALUATION BOARD

The AD9838 evaluation board allows designers to evaluate the high performance AD9838 DDS modulator with a minimum of effort.

### SYSTEM DEMONSTRATION PLATFORM

The system demonstration platform (SDP) is a hardware and software evaluation tool for use in conjunction with product evaluation boards. The SDP board is based on the Blackfin® ADSP-BF527 processor with USB connectivity to the PC through a USB 2.0 high speed port. For more information, see the SDP board product page.

Note that the SDP board is sold separately from the AD9838 evaluation board.

### AD9838 TO SPORT INTERFACE

The Analog Devices SDP board has a SPORT serial port that is used to control the serial inputs to the AD9838. The connections are shown in Figure 31.

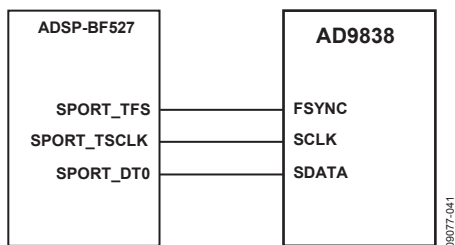

Figure 31. SDP to AD9838 Interface

### EVALUATION KIT

The DDS evaluation kit includes a populated, tested AD9838 printed circuit board (PCB). The schematics of the evaluation board are shown in Figure 33 and Figure 34.

The software provided in the evaluation kit allows the user to easily program the AD9838 (see Figure 32). The evaluation software runs on any IBM-compatible PC with Microsoft® Windows® software installed (including Windows 7). The software is compatible with both 32-bit and 64-bit operating systems.

More information about the evaluation software is available on the software CD and on the AD9838 product page.



Figure 32. AD9838 Evaluation Software Interface

### CRYSTAL OSCILLATOR VS. EXTERNAL CLOCK

The AD9838 can operate with master clocks up to 16 MHz. A 16 MHz oscillator is included on the evaluation board. This oscillator can be removed and, if required, an external CMOS clock can be connected to the part. Options for the general oscillator include the following:

- AEL 301-Series oscillators, AEL Crystals
- SG-310SCN oscillators, Epson Electronics

### POWER SUPPLY

Power to the AD9838 evaluation board can be provided from the USB connector or externally through pin connections. The power leads should be twisted to reduce ground loops.

EVALUATION BOARD SCHEMATICS

09077-042

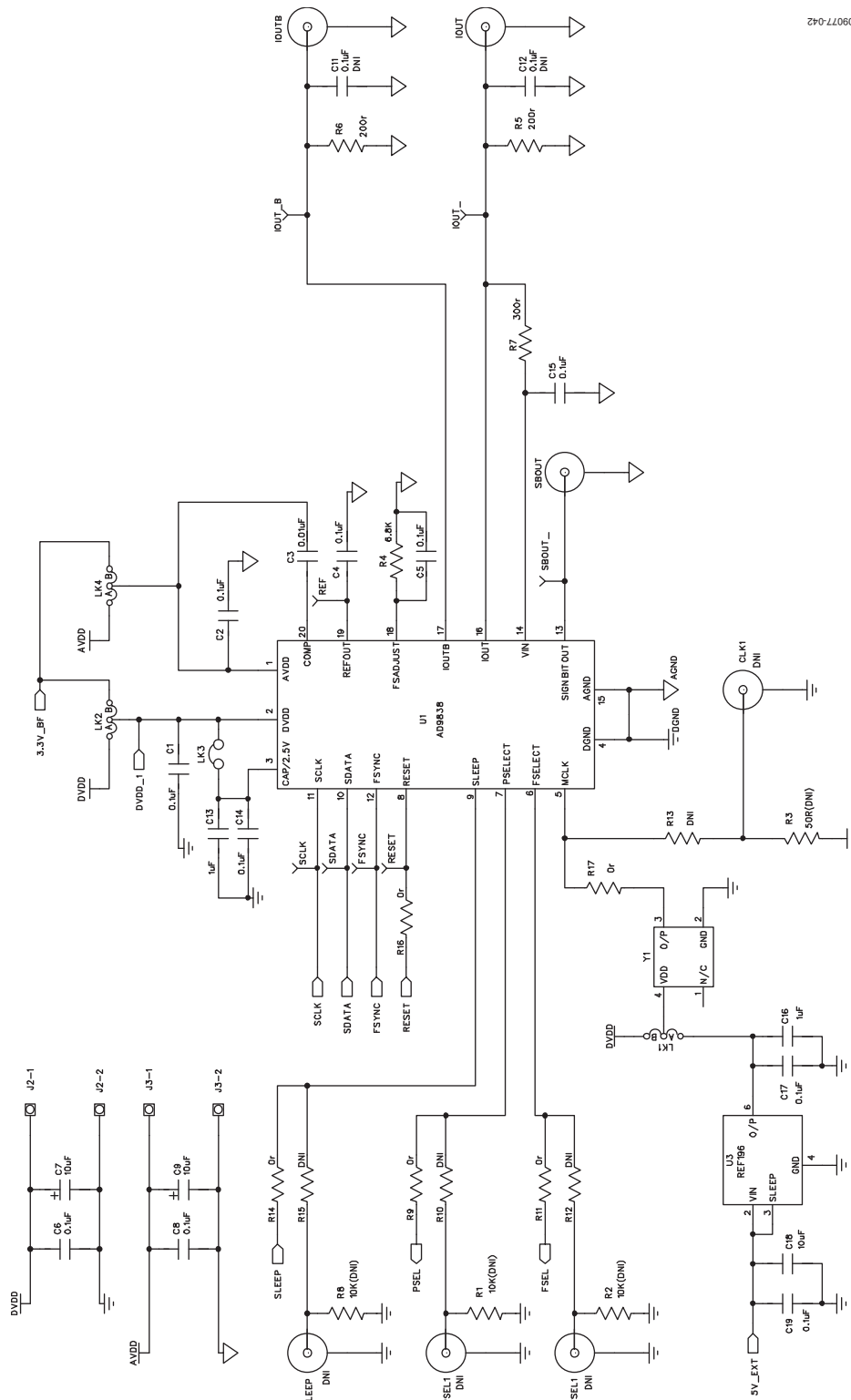
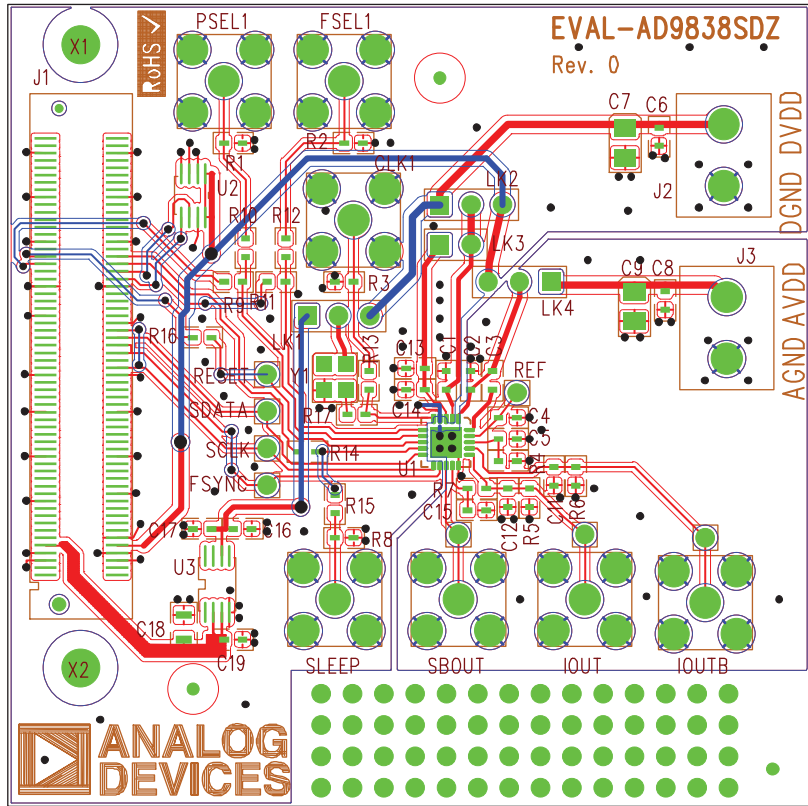

Figure 33. Evaluation Board Schematic



EVALUATION BOARD LAYOUT



EVAL-AD9838SDZ (Rev. 0) - Component Side View  
Layer 1 - Component Side  
Layer 2 - Solder Side  
Silkscreen

Figure 35. Evaluation Board Layout

## OUTLINE DIMENSIONS

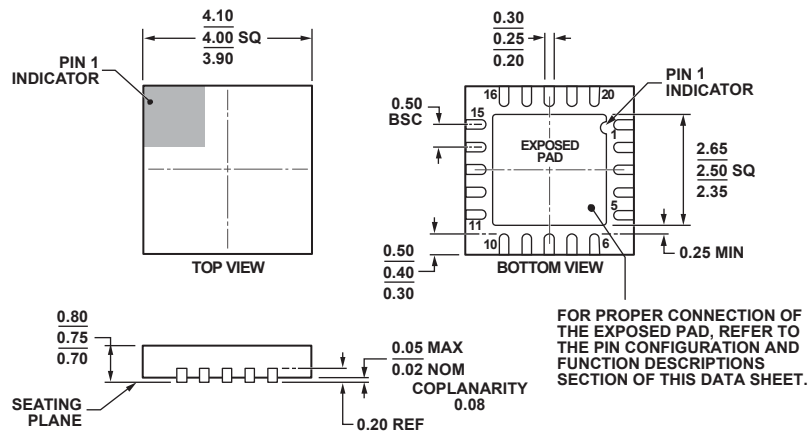

COMPLIANT TO JEDEC STANDARDS MO-220-WGGD.

Figure 36. 20-Lead Lead Frame Chip Scale Package [LFCSP\_WQ]  
 4 mm × 4 mm Body, Very Very Thin Quad  
 (CP-20-10)  
 Dimensions shown in millimeters

061609-B

## ORDERING GUIDE

| Model <sup>1,2</sup> | Temperature Range | Max MCLK | Package Description                              | Package Option |
|----------------------|-------------------|----------|--|----------------|
| AD9838BCPZ-RL        | -40°C to +125°C   | 16 MHz   | 20-Lead Lead Frame Chip Scale Package [LFCSP_WQ] | CP-20-10       |
| AD9838BCPZ-RL7       | -40°C to +125°C   | 16 MHz   | 20-Lead Lead Frame Chip Scale Package [LFCSP_WQ] | CP-20-10       |
| AD9838ACPZ-RL        | -40°C to +125°C   | 5 MHz    | 20-Lead Lead Frame Chip Scale Package [LFCSP_WQ] | CP-20-10       |
| AD9838ACPZ-RL7       | -40°C to +125°C   | 5 MHz    | 20-Lead Lead Frame Chip Scale Package [LFCSP_WQ] | CP-20-10       |
| EVAL-AD9838SDZ       |                   |          | Evaluation Board                                 |                |

<sup>1</sup> Z = RoHS Compliant Part.

<sup>2</sup> The evaluation board for the AD9838 requires the system demonstration platform (SDP) board, which is sold separately.

**NOTES**

**AD9838**

**NOTES**