

TPS6256x 2.25-MHz, 600-mA Step-Down Converter in TSOT and 2 × 2 × 0.8-mm QFN Package

1 Features

- Output Current up to 600 mA
- Input Voltage Range from 2.5 V to 5.5 V
- Output Voltage Accuracy in PWM Mode $\pm 2.5\%$
- Typical 15- μA Quiescent Current
- 100% Duty Cycle for Lowest Dropout
- Soft Start
- Available in a Small SOT, and 2 mm × 2 mm × 0.8 mm SON Package
- For Improved Features Set, See the TPS62290 device ([SLVS764](#))

2 Applications

- PDAs, Pocket PCs, Portable Media Players
- Low-Power DSP Supply
- Point-of-Load (POL) Applications

3 Description

The TPS62560 device is a high efficiency synchronous step down converter, optimized for battery powered portable applications. It provides up to 600-mA output current from batteries, such as single Li-Ion or other common chemistry AA and AAA cells.

With an input voltage range of 2.5 V to 5.5 V, the device is targeted to power a large variety of portable handheld equipment or POL applications.

The TPS62560 family operates at 2.25-MHz fixed switching frequency and enters a Power Save Mode operation at light load currents to maintain a high efficiency over the entire load current range.

The Power Save Mode is optimized for low output voltage ripple. For low noise applications, the device can be forced into fixed frequency PWM mode by pulling the MODE pin high. In the shutdown mode the current consumption is reduced to less than 1 μA . The TPS62560 allows the use of small inductors and capacitors to achieve a small solution size.

TPS62560 and TPS62562 are available in a 2-mm × 2-mm, 6-pin SON package, whereas the TPS62561 is available in a 5-pin SOT package.

Device Information⁽¹⁾

PART NUMBER	PACKAGE	BODY SIZE (NOM)
TPS62560, TPS62562	SON (6)	2.00 mm × 2.00 mm
TPS62561	SOT (5)	2.90 mm × 1.60 mm

(1) For all available packages, see the orderable addendum at the end of the data sheet.

Typical Application Schematic

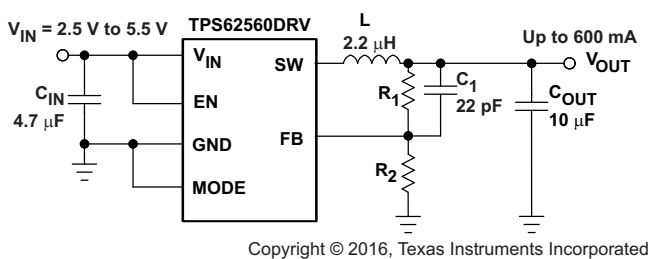

Efficiency vs Output Current

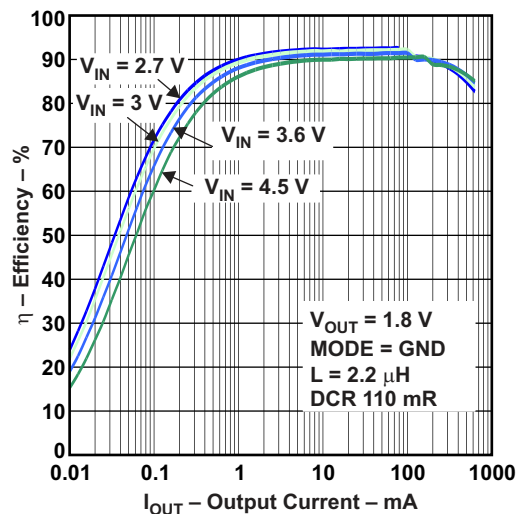

Table of Contents

1 Features	1	9 Application and Implementation	11
2 Applications	1	9.1 Application Information.....	11
3 Description	1	9.2 Typical Application	11
4 Revision History	2	9.3 System Examples	18
5 Device Comparison Table	4	10 Power Supply Recommendations	18
6 Pin Configuration and Functions	4	11 Layout	19
7 Specifications	5	11.1 Layout Guidelines	19
7.1 Absolute Maximum Ratings	5	11.2 Layout Examples.....	19
7.2 ESD Ratings.....	5	12 Device and Documentation Support	21
7.3 Recommended Operating Conditions.....	5	12.1 Device Support	21
7.4 Thermal Information	5	12.2 Related Links	21
7.5 Electrical Characteristics.....	6	12.3 Receiving Notification of Documentation Updates	21
7.6 Typical Characteristics	7	12.4 Community Resources.....	21
8 Detailed Description	8	12.5 Trademarks	21
8.1 Overview	8	12.6 Electrostatic Discharge Caution.....	21
8.2 Functional Block Diagram	8	12.7 Glossary	21
8.3 Feature Description.....	9	13 Mechanical, Packaging, and Orderable	
8.4 Device Functional Modes.....	10	Information	22

4 Revision History

NOTE: Page numbers for previous revisions may differ from page numbers in the current version.

Changes from Revision C (December 2009) to Revision D	Page
• Added <i>ESD Ratings</i> table, <i>Feature Description</i> section, <i>Device Functional Modes</i> , <i>Application and Implementation</i> section, <i>Power Supply Recommendations</i> section, <i>Layout</i> section, <i>Device and Documentation Support</i> section, and <i>Mechanical, Packaging, and Orderable Information</i> section.	1
• Removed <i>Ordering Information</i> table	1
• Changed text string From ".....up to 1000-mA output current.." To ".....up to 600-mA output current.." in Description	1
• Corrected typographical errors in Figure 32 ; from " $V_{IN} = 2\text{ V to }6\text{ V}$ " to " $V_{IN} = 2.5\text{ V to }5.5\text{ V}$ "	18

Changes from Revision B (March 2009) to Revision C	Page
• Deleted High Efficiency Step Down Converter	1
• Deleted "Wide" from Features bullet	1
• Deleted "for Li-Ion Batteries With Extended Voltage Range" from Features	1
• Deleted "Adjustable and Fixed Output-Voltage Options" from Features.....	1
• Deleted "2.25 MHz Fixed Frequency Operation" from Features	1
• Deleted "Power Save Mode at Light Load Currents" from Features	1
• Deleted "Voltage Positioning at Light Loads" from Features.....	1
• Deleted "Allows < 1-mm Solution Height" from Features.....	1
• Changed Description to better reflect device capabilities and differences to TPS62260.....	1

Changes from Revision A (July 2008) to Revision B	Page
• Added TPS62562 device number.....	1

Changes from Original (January 2008) to Revision A

Page

-
- Changed at all levels. Revision A is a complete rewrite of this data sheet. **1**
-

5 Device Comparison Table

Part Number	Package	Mode Pin	Output Voltage ⁽¹⁾	Device Marking ⁽²⁾
TPS62560	SON (6)	yes	Adjustable	GEY
TPS62561	SOT (5)	forced PWM only	Adjustable	CVO
TPS62562	SON (6)	yes	1.8 V fixed	NXT

(1) Contact TI for other fixed output voltage options

(2) For the most current package and ordering information, see [Mechanical, Packaging, and Orderable Information](#), or see the TI website at www.ti.com

6 Pin Configuration and Functions



Pin Functions

NAME	PIN		I/O	DESCRIPTION
	No. QFN-6	No. TSOT23-5		
EN	4	3	I	This is the enable pin of the device. Pulling this pin to low forces the device into shutdown mode. Pulling this pin to high enables the device. This pin must be terminated.
FB	3	4	I	Feedback pin for the internal regulation loop. Connect the external resistor divider to this pin. In the fixed-output-voltage option, connect this terminal directly to the output capacitor.
GND	6	2	—	GND supply pin
MODE	2	N/A	I	This pin is only available as a QFN package option. MODE pin = high forces the device to operate in the fixed-frequency PWM mode. MODE pin = low enables the power-save mode with automatic transition from PFM mode to fixed-frequency PWM mode.
SW	1	5	O	This is the switch pin and is connected to the internal MOSFET switches. Connect the external inductor between this pin and the output capacitor.
V_{IN}	5	1	—	V_{IN} power-supply pin
Exposed Thermal Pad	—	N/A	—	Must be soldered to achieve appropriate power dissipation. Should be connected to GND.

7 Specifications

7.1 Absolute Maximum Ratings

over operating free-air temperature range (unless otherwise noted)⁽¹⁾

	MIN	MAX	UNIT
Input voltage range ⁽²⁾	-0.3	7	V
Voltage range at EN, MODE	-0.3	$V_{IN} + 0.3, \leq 7$	
Voltage on SW	-0.3	7	
Peak output current	Internally limited		A
T _J Maximum operating junction temperature	-40	125	°C
T _{stg} Storage temperature	-65	150	°C

- (1) Stresses beyond those listed under *absolute maximum ratings* may cause permanent damage to the device. These are stress ratings only and functional operation of the device at these or any other conditions beyond those indicated under *recommended operating conditions* is not implied. Exposure to absolute-maximum-rated conditions for extended periods may affect device reliability.
- (2) All voltage values are with respect to the network ground terminal.

7.2 ESD Ratings

	VALUE	UNIT
V _(ESD) Electrostatic discharge ⁽¹⁾	Human-body model (HBM), per ANSI/ESDA/JEDEC JS-001 ⁽²⁾	±2000
	Charged-device model (CDM), per JEDEC specification JESD22-C101 ⁽³⁾	±1000
	Machine model	±200

- (1) The human-body model is a 100-pF capacitor discharged through a 1.5-kΩ resistor into each terminal. The machine model is a 200-pF capacitor discharged directly into each terminal.
- (2) JEDEC document JEP155 states that 500-V HBM allows safe manufacturing with a standard ESD control process. Manufacturing with less than 500-V HBM is possible with the necessary precautions.
- (3) JEDEC document JEP157 states that 250-V CDM allows safe manufacturing with a standard ESD control process. Manufacturing with less than 250-V CDM is possible with the necessary precautions.

7.3 Recommended Operating Conditions

	MIN	MAX	UNIT
V _{IN} Supply voltage	2.5	5.5	V
V _{OUT} Output voltage range for adjustable voltage	0.85	V _{IN}	V
T _A Operating ambient temperature	-40	85	°C
T _J Operating junction temperature	-40	125	°C

7.4 Thermal Information

THERMAL METRIC ⁽¹⁾	TPS62560, TPS62562	TPS62561	UNIT
	DRV (SON)	DDC (SOT)	
	6 PINS	5 PINS	
R _{θJA} Junction-to-ambient thermal resistance	67.8	226.9	°C/W
R _{θJC(top)} Junction-to-case (top) thermal resistance	88.5	40.7	°C/W
R _{θJB} Junction-to-board thermal resistance	37.2	48.8	°C/W
ψ _{JT} Junction-to-top characterization parameter	2.0	0.5	°C/W
ψ _{JB} Junction-to-board characterization parameter	37.6	48.1	°C/W
R _{θJC(bot)} Junction-to-case (bottom) thermal resistance	7.9	n/a	°C/W

- (1) For more information about traditional and new thermal metrics, see the *Semiconductor and IC Package Thermal Metrics* application report, [SPRA953](#).

7.5 Electrical Characteristics

Over full operating ambient temperature range, typical values are at $T_A = 25^\circ\text{C}$. Unless otherwise noted, specifications apply for condition $V_{IN} = EN = 3.6\text{ V}$. External components $C_{IN} = 4.7\ \mu\text{F}$ 0603, $C_{OUT} = 10\ \mu\text{F}$ 0603, $L = 2.2\ \mu\text{H}$

PARAMETER		TEST CONDITIONS	MIN	TYP	MAX	UNIT
SUPPLY						
V_{IN}	Input voltage range		2.5		5.5	V
I_{OUT}	Output current	$V_{IN} = 2.5\text{ V to }5.5\text{ V}$			600	mA
I_Q	Operating quiescent current	$I_{OUT} = 0\text{ mA}$, PFM mode enabled (MODE = GND), device not switching		15		μA
		$I_{OUT} = 0\text{ mA}$, PFM mode enabled (MODE = GND), device switching, $V_{OUT} = 1.8\text{ V}$, See (1)		18.5		
		$I_{OUT} = 0\text{ mA}$, switching with no load (MODE = V_{IN}), PWM operation, $V_{OUT} = 1.8\text{ V}$, $V_{IN} = 3\text{ V}$		3.8		mA
I_{SD}	Shutdown current	EN = GND		0.5		μA
UVLO	Undervoltage lockout threshold	Falling		1.85		V
		Rising		1.95		
ENABLE, MODE						
V_{IH}	High-level input voltage, EN, MODE	$2\text{ V} \leq V_{IN} \leq 5.5\text{ V}$	1		V_{IN}	V
V_{IL}	Low-level input voltage, EN, MODE	$2\text{ V} \leq V_{IN} \leq 5.5\text{ V}$	0		0.4	V
I_{IN}	Input bias current, EN, MODE	EN, MODE = GND or V_{IN}		0.01	1	μA
POWER SWITCH						
$R_{DS(on)}$	High side MOSFET on-resistance	$V_{IN} = V_{GS} = 3.6\text{ V}$, $T_A = 25^\circ\text{C}$		252	492	m Ω
	Low side MOSFET on-resistance			194	391	
I_{LIMF}	Forward current limit, high and low side MOSFET	$V_{IN} = V_{GS} = 3.6\text{ V}$	0.8	1	1.2	A
T_{SD}	Thermal shutdown	Increasing junction temperature		140		$^\circ\text{C}$
	Thermal-shutdown hysteresis	Decreasing junction temperature		20		
OSCILLATOR						
f_{SW}	Oscillator frequency	$2\text{ V} \leq V_{IN} \leq 5.5\text{ V}$		2.25		MHz
OUTPUT						
V_{OUT}	Adjustable-output voltage range		0.85		V_{IN}	V
V_{OUT}	TPS62562 fixed output voltage	$V_{IN} \geq 1.8\text{ V}$		1.8		V
V_{ref}	Reference voltage			600		mV
V_{FB}	Feedback voltage, PWM mode	MODE = V_{IN} , PWM operation, for fixed-output-voltage versions $V_{FB} = V_{OUT}$, $2.5\text{ V} \leq V_{IN} \leq 5.5\text{ V}$, $0\text{ mA} \leq I_{OUT} \leq 600\text{ mA}$ (2)	-2.5%	0%	2.5%	
	Feedback voltage, PFM mode	MODE = GND, device in PFM mode, voltage positioning active (1)		1%		
	Load regulation	PWM mode		-1		
$t_{Start\ Up}$	Start-up time	Time from active EN to reach 95% of V_{OUT} nominal		500		μs
t_{Ramp}	V_{OUT} ramp-up time	Time to ramp from 5% to 95% of V_{OUT}		250		μs
I_{ikg}	Leakage current into SW terminal	$V_{IN} = 3.6\text{ V}$, $V_{IN} = V_{OUT} = V_{SW}$, EN = GND (3)		0.5	1	μA

(1) In PFM mode, the internal reference voltage is set to typ. $1.01 \times V_{ref}$. See the section.

(2) For $V_{IN} = V_{OUT} + 0.6\text{ V}$

(3) In fixed-output-voltage versions, the internal resistor divider network is disconnected from the FB terminal.

7.6 Typical Characteristics

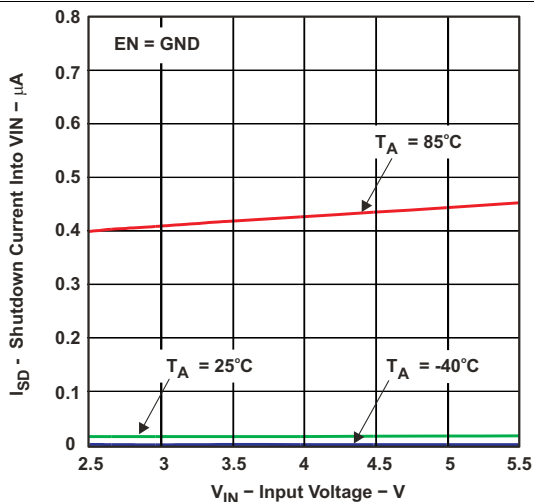

Figure 1. Shutdown Current into VIN vs Input Voltage

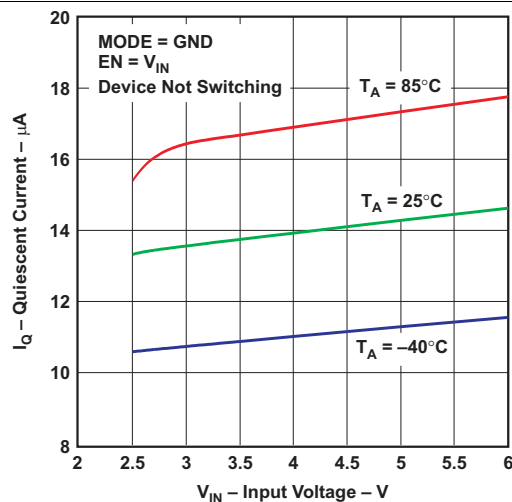

Figure 2. Quiescent Current vs Input Voltage

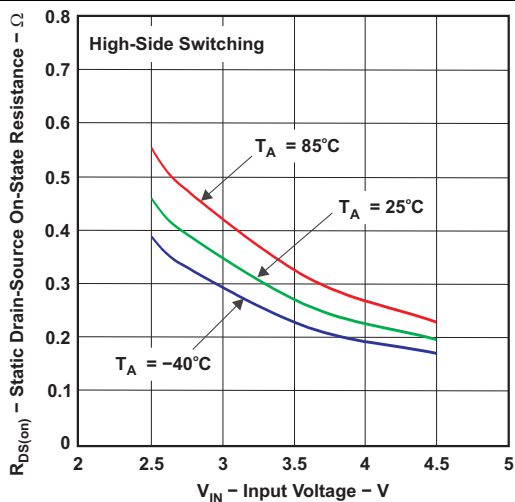

Figure 3. Static Drain-Source ON-State Resistance

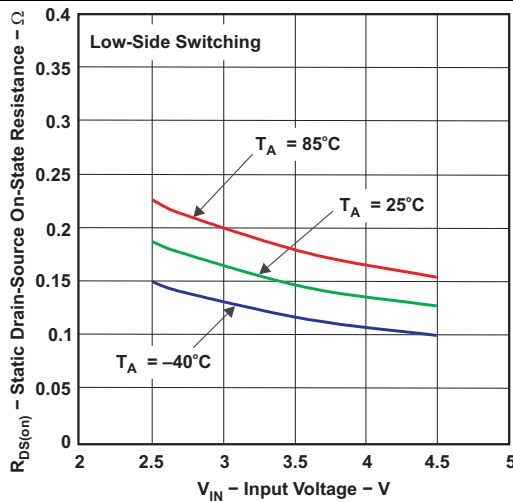

Figure 4. Static Drain-Source ON-State Resistance vs Input Voltage

8 Detailed Description

8.1 Overview

The TPS62560/62 step-down converters operate with typically 2.25-MHz fixed-frequency pulse-width modulation (PWM) at moderate to heavy load currents. At light load currents, the converter can automatically enter power-save mode, and then operates in PFM mode. However, the TPS62561 operates with fixed-frequency PWM only, also at light load conditions.

During PWM operation, the converter uses a unique fast-response voltage-mode control scheme with input-voltage feed-forward to achieve good line and load regulation, allowing the use of small ceramic input and output capacitors. At the beginning of each clock cycle initiated by the clock signal, the high-side MOSFET switch is turned on. The current flows from the input capacitor via the high-side MOSFET switch through the inductor to the output capacitor and load. During this phase, the current ramps up until the PWM comparator trips and the control logic turns off the switch. The current-limit comparator also turns off the switch in case the current limit of the high-side MOSFET switch is exceeded. After a dead time, which prevents shoot-through current, the low-side MOSFET rectifier is turned on and the inductor current ramps down. The current flows from the inductor to the output capacitor and to the load. It returns back to the inductor through the low-side MOSFET rectifier.

The next cycle is initiated by the clock signal again turning off the low-side MOSFET rectifier and turning on the on the high-side MOSFET switch.

8.2 Functional Block Diagram

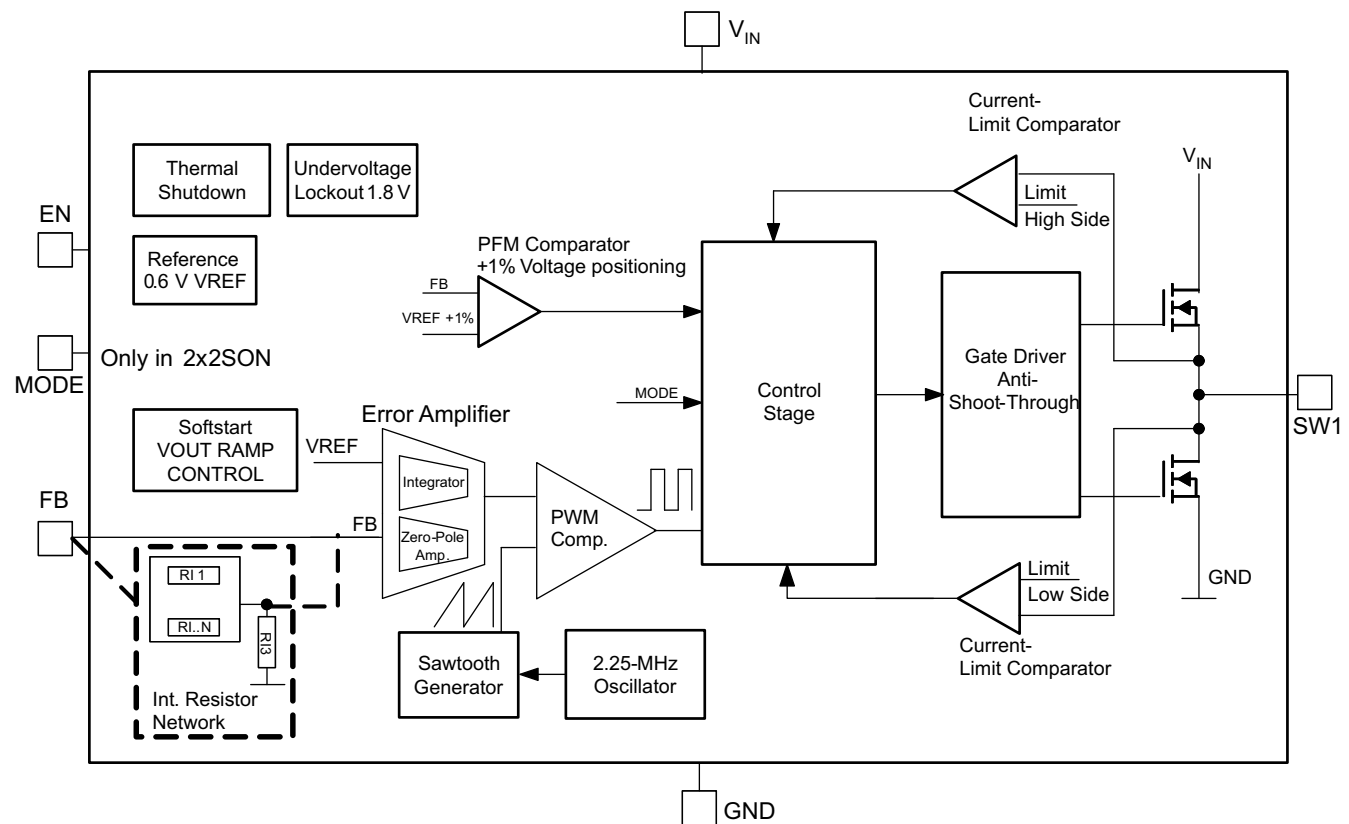

Copyright © 2016, Texas Instruments Incorporated

8.3 Feature Description

8.3.1 Dynamic Voltage Positioning

This feature reduces the voltage under/overshoots at load steps from light to heavy load and vice versa. It is active in power-save mode and regulates the output voltage 1% higher than the nominal value. This provides more headroom for both the voltage drop at a load step, and the voltage increase at a load throw-off.

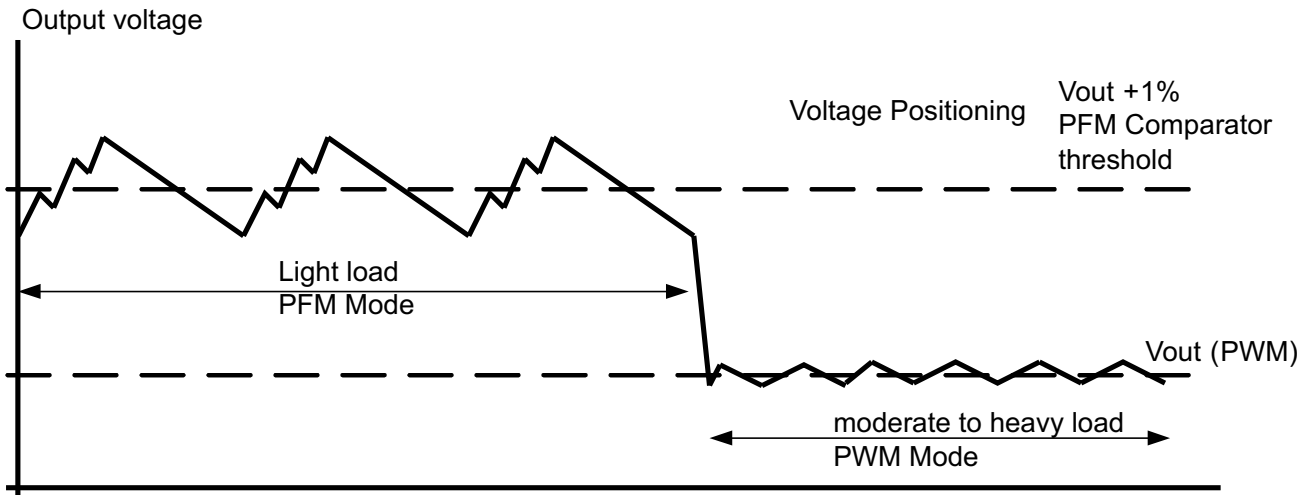

Figure 5. Power Save Mode Operation With Automatic Mode Transition

8.3.2 Undervoltage Lockout

The undervoltage lockout circuit prevents the device from malfunctioning at low input voltages and from excessive discharge of the battery and disables the output stage of the converter. The undervoltage lockout threshold is typically 1.85 V with falling V_{IN} .

8.3.3 Mode Selection

The MODE terminal allows mode selection between forced-PWM mode and power-save mode.

Connecting this terminal to GND enables the power-save mode with automatic transition between PWM and PFM modes. Pulling the MODE terminal high forces the converter to operate in fixed-frequency PWM mode even at light load currents. This allows simple filtering of the switching frequency for noise-sensitive applications. In this mode, the efficiency is lower compared to the power-save mode during light loads.

The state of the MODE terminal can be changed during operation to allow efficient power management by adjusting the operation mode of the converter to the specific system requirements.

8.3.4 Enable

The device is enabled by setting the EN terminal to high. During the start-up time $t_{Start Up}$, the internal circuits are settled and the soft-start circuit is activated. The EN input can be used to control power sequencing in a system with various dc/dc converters. The EN terminal can be connected to the output of another converter, to drive the EN terminal high to achieve a sequencing of the given supply rails. With EN = GND, the device enters shutdown mode, in which all internal circuits are disabled. In fixed-output-voltage versions, the internal resistor divider network is then disconnected from the FB terminal.

8.3.5 Thermal Shutdown

As soon as the junction temperature, T_J , exceeds 140°C (typical), the device goes into thermal shutdown. In this mode, the high-side and low-side MOSFETs are turned off. The device continues its operation when the junction temperature falls below the thermal shutdown hysteresis.

8.4 Device Functional Modes

8.4.1 Soft-Start

The TPS62560 has an internal soft-start circuit that controls the ramp-up of the output voltage. The output voltage ramps up from 5% to 95% of its nominal value typically within 250 μ s. This limits the inrush current into the converter during ramp-up and prevents possible input voltage drops when a battery or high-impedance power source is used. The soft-start circuit is enabled within the start-up time $t_{Start Up}$.

8.4.2 Power-Save Mode

The power-save mode is enabled with the MODE terminal set to the low level. If the load current decreases, the converter enters the power-save mode of operation automatically. During power-save mode, the converter skips switching and operates with reduced frequency in PFM mode with a minimum quiescent current to maintain high efficiency. The converter positions the output voltage typically 1% above the nominal output voltage. This voltage positioning feature minimizes voltage drops caused by a sudden load step.

The transition from PWM mode to PFM mode occurs once the inductor current in the low-side MOSFET switch becomes zero, which indicates discontinuous conduction mode.

During the power-save mode, the output voltage is monitored with a PFM comparator. As the output voltage falls below the PFM comparator threshold of V_{OUT} nominal + 1%, the device starts a PFM current pulse. The high-side MOSFET switch turns on, and the inductor current ramps up. After the on-time expires, the switch is turned off and the low-side MOSFET switch is turned on until the inductor current becomes zero.

The converter effectively delivers a current to the output capacitor and the load. If the load is below the delivered current, the output voltage rises. If the output voltage is equal to or higher than the PFM comparator threshold, the device stops switching and enters a sleep mode with typical 15- μ A current consumption.

If the output voltage is still below the PFM comparator threshold, a sequence of further PFM current pulses is generated until the PFM comparator threshold is reached. The converter starts switching again once the output voltage drops below the PFM comparator threshold.

With a fast single-threshold comparator, the output-voltage ripple during PFM-mode operation can be kept small. The PFM pulse is time controlled, which allows modifying the charge transferred to the output capacitor by the value of the inductor. The resulting PFM output-voltage ripple and PFM frequency depend primarily on the size of the output capacitor and the inductor value. Increasing output capacitor values and inductor values minimizes the output ripple. The PFM frequency decreases with smaller inductor values and increases with larger values.

The PFM mode is left and PWM mode entered in case the output current can no longer be supported in PFM mode. The power-save mode can be disabled by setting the MODE terminal to high. The converter then operates in the fixed-frequency PWM mode.

8.4.2.1 100% Duty-Cycle Low-Dropout Operation

The device starts to enter 100% duty-cycle mode once the input voltage comes close to the nominal output voltage. In order to maintain the output voltage, the high-side MOSFET switch is turned on 100% for one or more cycles.

With further decreasing V_{IN} , the high-side MOSFET switch is turned on completely. In this case, the converter offers a low input-to-output voltage difference. This is particularly useful in battery-powered applications to achieve longest operation time by taking full advantage of the whole battery-voltage range.

The minimum input voltage to maintain regulation depends on the load current and output voltage; and, can be calculated as:

$$V_{INmin} = V_{OUTmax} + I_{OUTmax} \times (R_{DS(on)}max + R_L)$$

where

- I_{OUTmax} = maximum output current plus inductor ripple current
- $R_{DS(on)}max$ = maximum P-channel switch $R_{DS(on)}$
- R_L = dc resistance of the inductor
- V_{OUTmax} = nominal output voltage plus maximum output voltage tolerance

(1)

Device Functional Modes (continued)

8.4.2.2 Short-Circuit Protection

The high-side and low-side MOSFET switches are short-circuit protected with maximum switch current = I_{LIMF} . The current in the switches is monitored by current-limit comparators. Once the current in the high-side MOSFET switch exceeds the threshold of its current-limit comparator, it turns off and the low-side MOSFET switch is activated to ramp down the current in the inductor and high-side MOSFET switch. The high-side MOSFET switch can only turn on again after the current in the low-side MOSFET switch has decreased below the threshold of its current-limit comparator.

9 Application and Implementation

NOTE

Information in the following applications sections is not part of the TI component specification, and TI does not warrant its accuracy or completeness. TI's customers are responsible for determining suitability of components for their purposes. Customers should validate and test their design implementation to confirm system functionality.

9.1 Application Information

The TPS6256x devices are high-efficiency synchronous step-down DC–DC converter featuring power-save mode or 2.25-MHz fixed frequency operation.

9.2 Typical Application

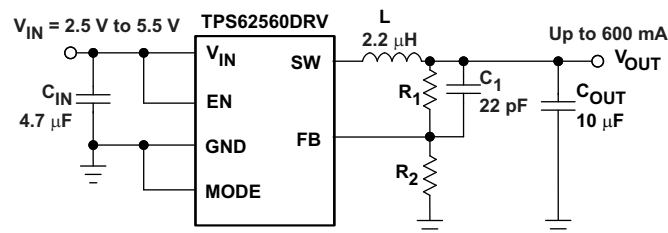

Copyright © 2016, Texas Instruments Incorporated

Figure 6. TPS62560DRV Adjustable

9.2.1 Design Requirements

The TPS6256x is a highly integrated DC/DC converter. The output voltage is set with an external voltage divider for the adjustable output voltage version. The output voltage is fixed to 1.8V for the TPS62562. For proper operation a input- and output capacitor and an inductor is required. Table 2 shows the components used for the application characteristic curves.

9.2.2 Detailed Design Procedure

9.2.2.1 Output Voltage Setting

For adjustable output voltage versions, the output voltage can be calculated by Equation 2 with the internal reference voltage $V_{REF} = 0.6$ V typically.

$$V_{OUT} = V_{REF} \times \left(1 + \frac{R_1}{R_2} \right) \quad (2)$$

To minimize the current through the feedback divider network, R_2 should be 180 k Ω or 360 k Ω . The sum of R_1 and R_2 should not exceed ~ 1 M Ω , to keep the network robust against noise. An external feed-forward capacitor C_1 is required for optimum load transient response. The value of C_1 should be in the range between 22 pF and 33 pF.

In case of using the fixed output voltage version (TPS62562), V_{out} has to be connected to the feedback pin FB.

Typical Application (continued)

Route the FB line away from noise sources, such as the inductor or the SW line.

9.2.2.2 Output Filter Design (inductor and Output Capacitor)

The TPS62560 is designed to operate with inductors in the range of 1.5 μH to 4.7 μH and with output capacitors in the range of 4.7 μF to 22 μF . The part is optimized for operation with a 2.2- μH inductor and 10- μF output capacitor.

Larger or smaller inductor values can be used to optimize the performance of the device for specific operation conditions. For stable operation, the L and C values of the output filter may not fall below 1 μH effective inductance and 3.5 μF effective capacitance.

9.2.2.2.1 Inductor Selection

The inductor value has a direct effect on the ripple current. The selected inductor must be rated for its dc resistance and saturation current. The inductor ripple current (ΔI_L) decreases with higher inductance and increases with higher V_{IN} or V_{OUT} .

The inductor selection also impacts the output voltage ripple in PFM mode. Higher inductor values lead to lower output voltage ripple and higher PFM frequency; lower inductor values lead to a higher output voltage ripple but lower PFM frequency.

[Equation 3](#) calculates the maximum inductor current in PWM mode under static load conditions. The saturation current of the inductor should be rated higher than the maximum inductor current as calculated with [Equation 4](#). This is recommended because during heavy load transients the inductor current rises above the calculated value.

$$\Delta I_L = V_{\text{OUT}} \times \frac{1 - \frac{V_{\text{OUT}}}{V_{\text{IN}}}}{L \times f} \quad (3)$$

$$I_{L \text{ max}} = I_{\text{out max}} + \frac{\Delta I_L}{2}$$

where

- f = Switching frequency (2.25 MHz, typical)
 - L = Inductor value
 - ΔI_L = Peak-to-peak inductor ripple current
 - $I_{L \text{ max}}$ = Maximum inductor current
- (4)

A more conservative approach is to select the inductor current rating just for the switch current limit $I_{L \text{ LIMF}}$ of the converter.

Accepting larger values of ripple current allows the use of lower inductance values, but results in higher output voltage ripple, greater core losses, and lower output current capability.

The total losses of the coil have a strong impact on the efficiency of the dc/dc conversion and consist of both the losses in the dc resistance (R_{DC}) and the following frequency-dependent components:

- The losses in the core material (magnetic hysteresis loss, especially at high switching frequencies)
- Additional losses in the conductor from the skin effect (current displacement at high frequencies)
- Magnetic field losses of the neighboring windings (proximity effect)
- Radiation losses

Table 1. List of Inductors

DIMENSIONS, mm	INDUCTANCE, μH	INDUCTOR TYPE	SUPPLIER ⁽¹⁾
2,5 × 2 × 1 max	2	MIPS2520D2R2	FDK
2,5 × 2 × 1,2 max	2	MIPSA2520D2R2	FDK
2,5 × 2 × 1 max	2.2	KSLI-252010AG2R2	Hitachi Metals
2,5 × 2 × 1,2 max	2.2	LQM2HPN2R2MJ0L	Murata
3 × 3 × 1,5 max	2.2	LPS3015 2R2	Coilcraft

(1) See [Third-Party Products Disclaimer](#)

9.2.2.2.2 Output Capacitor Selection

The advanced fast-response voltage-mode control scheme of the TPS62560 allows the use of tiny ceramic capacitors. Ceramic capacitors with low ESR values have the lowest output voltage ripple and are recommended. The output capacitor requires either an X7R or X5R dielectric. Y5V and Z5U dielectric capacitors, aside from their wide variation in capacitance over temperature, become resistive at high frequencies.

At nominal load current, the device operates in PWM mode, and the RMS ripple current is calculated by [Equation 5](#):

$$I_{\text{RMS}C_{\text{OUT}}} = V_{\text{OUT}} \times \frac{1 - \frac{V_{\text{OUT}}}{V_{\text{IN}}}}{L \times f} \times \frac{1}{2\sqrt{3}} \quad (5)$$

At nominal load current, the device operates in PWM mode, and the overall output voltage ripple is the sum of the voltage spike caused by the output capacitor ESR plus the voltage ripple caused by charging and discharging the output capacitor shown in [Equation 6](#):

$$\Delta V_{\text{OUT}} = V_{\text{OUT}} \times \frac{1 - \frac{V_{\text{OUT}}}{V_{\text{IN}}}}{L \times f} \times \left(\frac{1}{8 \times C_{\text{OUT}} \times f} + \text{ESR} \right) \quad (6)$$

At light load currents, the converter operates in power-save mode, and the output voltage ripple is dependent on the output capacitor and inductor values. Larger output capacitor and inductor values minimize the voltage ripple in PFM mode and tighten dc output accuracy in PFM mode.

9.2.2.2.3 Input Capacitor Selection

An input capacitor is required for best input voltage filtering and minimizing the interference with other circuits caused by high input voltage spikes. For most applications, a 4.7- μF to 10- μF ceramic capacitor is recommended. Because a ceramic capacitor loses up to 80% of its initial capacitance at 5 V, it is recommended that 10- μF input capacitors be used for input voltages > 4.5 V. The input capacitor can be increased without any limit for better input voltage filtering. Take care when using only small ceramic input capacitors. When a ceramic capacitor is used at the input and the power is being supplied through long wires, such as from a wall adapter, a load step at the output or V_{IN} step on the input can induce ringing at the V_{IN} terminal. This ringing can couple to the output and be mistaken as loop instability or could even damage the part by exceeding the maximum ratings.

Table 2. List of Capacitors⁽¹⁾

CAPACITANCE	TYPE	SIZE	SUPPLIER
4.7 μF	GRM188R60J475K	0603—1,6 × 0,8 × 0,8 mm	Murata
10 μF	GRM188R60J106M69D	0603—1,6 × 0,8 × 0,8 mm	Murata

(1) See [Third-Party Products Disclaimer](#)

9.2.3 Application Curves

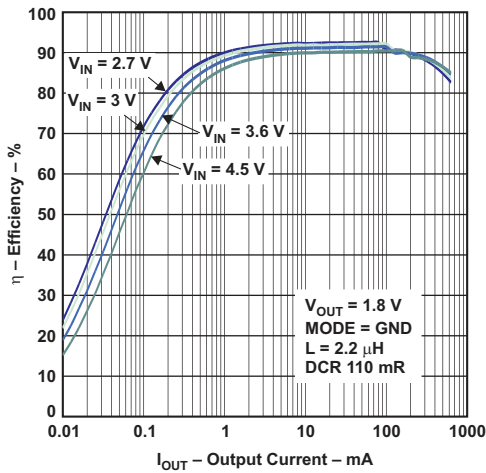

Figure 7. Efficiency vs Output Current

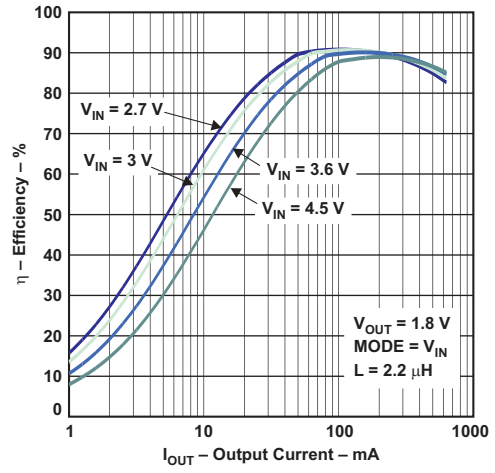

Figure 8. Efficiency vs Output Current

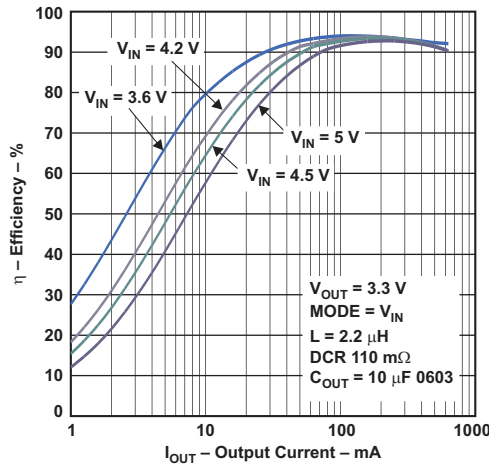

Figure 9. Efficiency vs Output Current

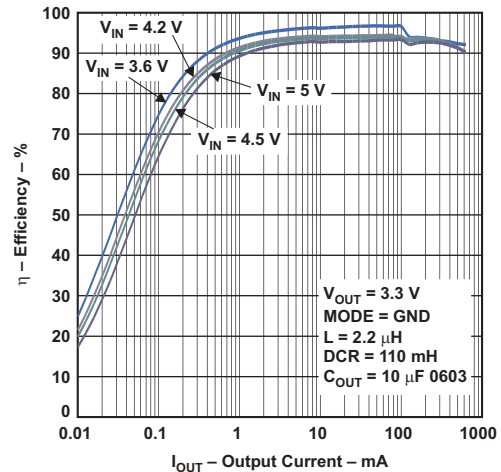

Figure 10. Efficiency vs Output Current

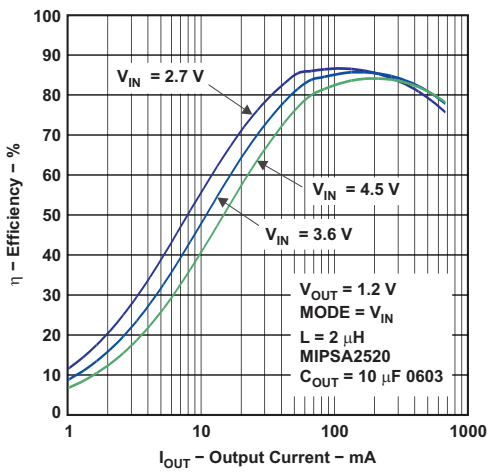

Figure 11. Efficiency vs Output Current

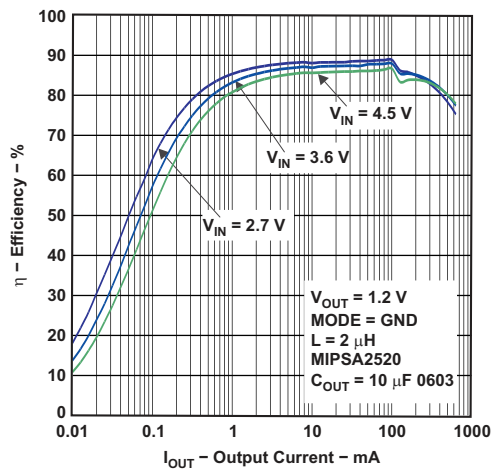

Figure 12. Efficiency vs Output Current

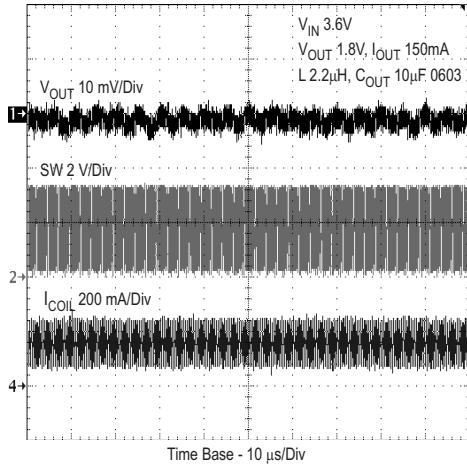

Figure 13. Typical Operation - PWM Mode

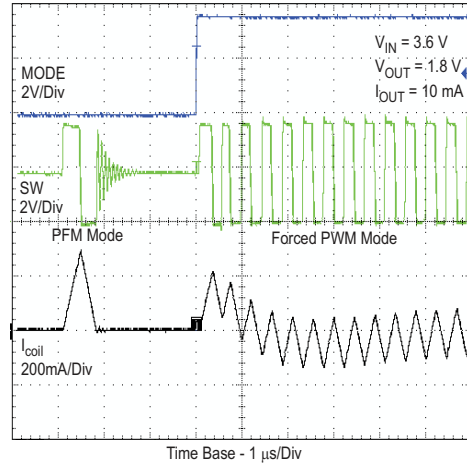

Figure 14. Mode Pin Transition from PFM to FORCED PWM Mode at Light Load

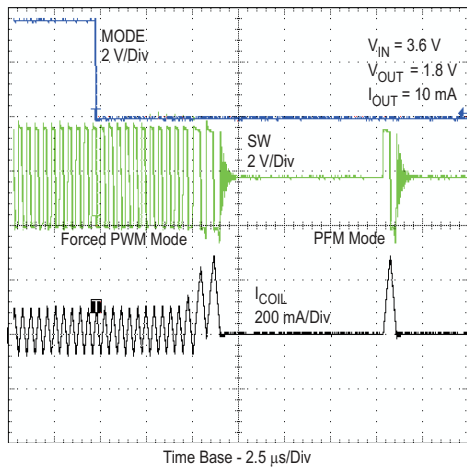

Figure 15. Mode Pin Transition from PWM to PFM MODE at Light Load

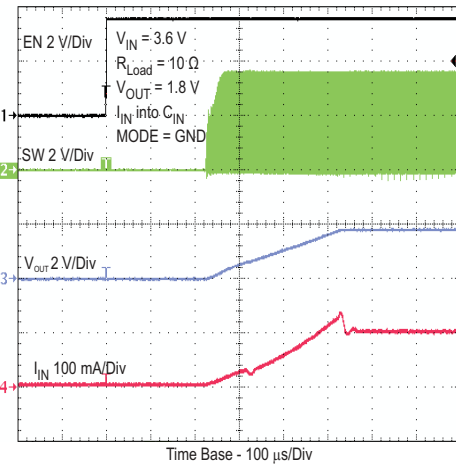

Figure 16. Start-UP Timing

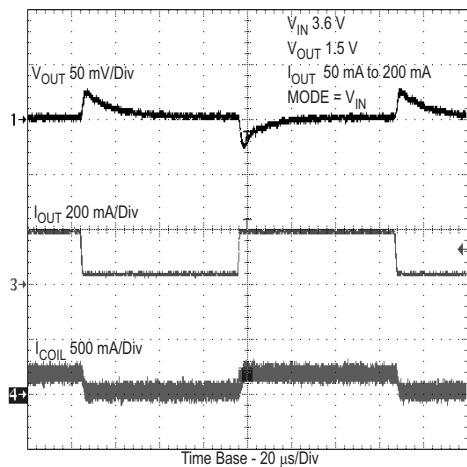

Figure 17. Forced PWM Load Transient

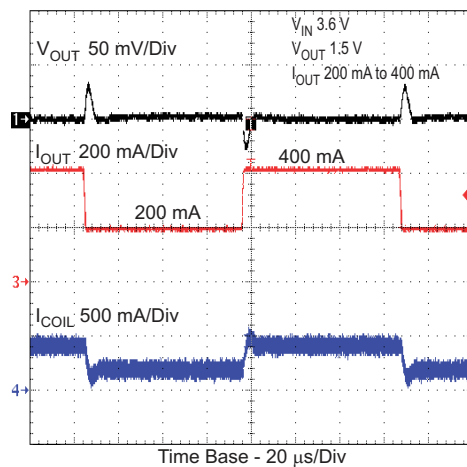

Figure 18. Forced PWM Load Transient

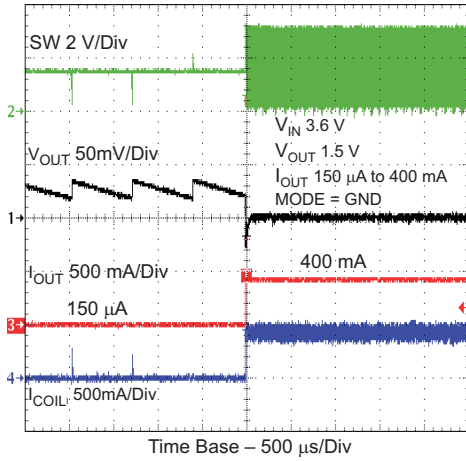

Figure 19. PFM Load Transient

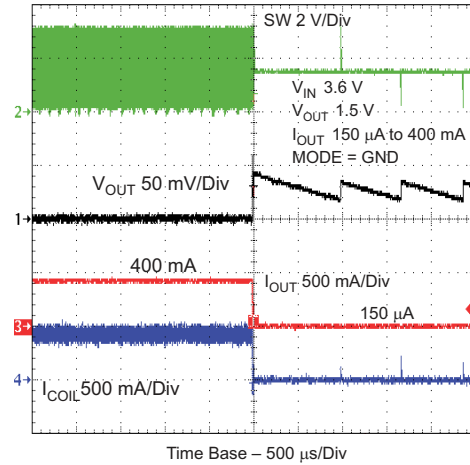

Figure 20. PFM Load Transient

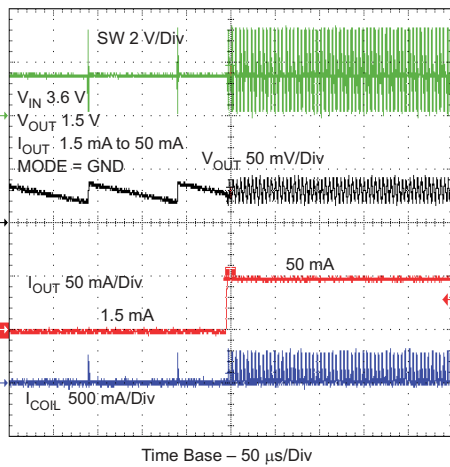

Figure 21. PFM Load Transient

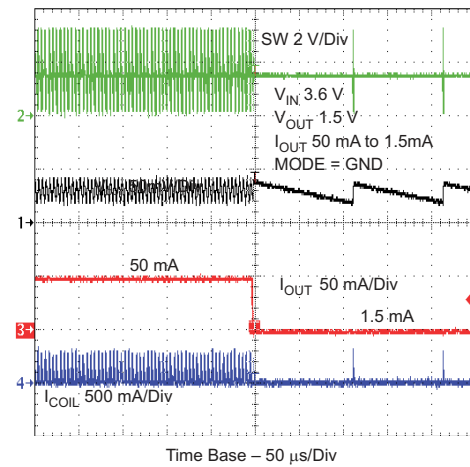

Figure 22. PFM Load Transient

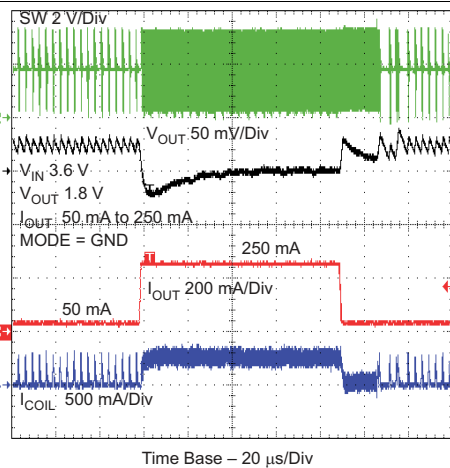

Figure 23. PFM Load Transient

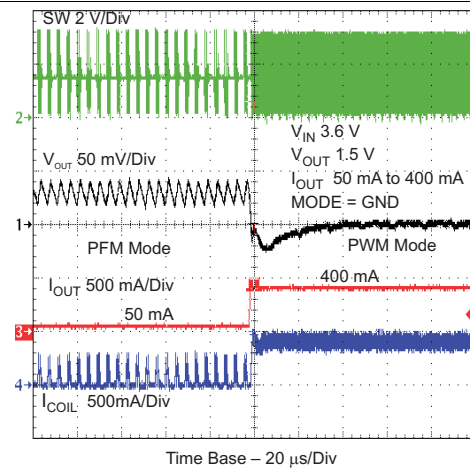

Figure 24. PFM Load Transient

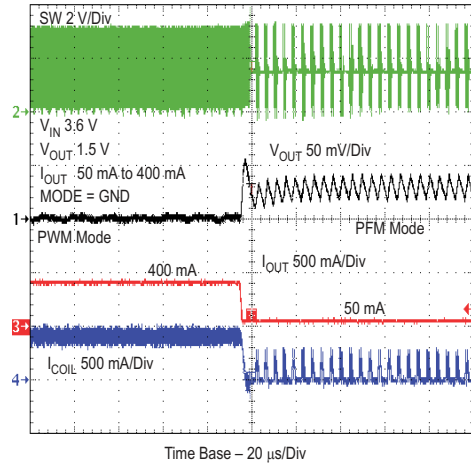

Figure 25. PFM Load Transient

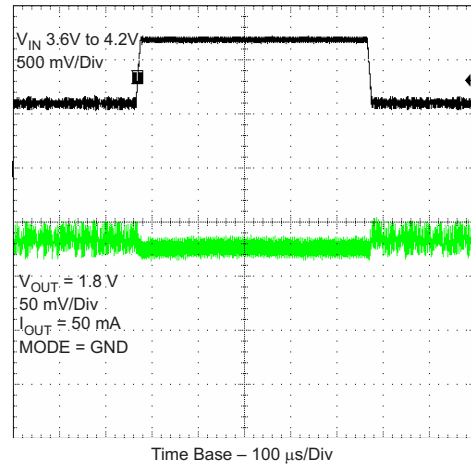

Figure 26. PFM Line Transient

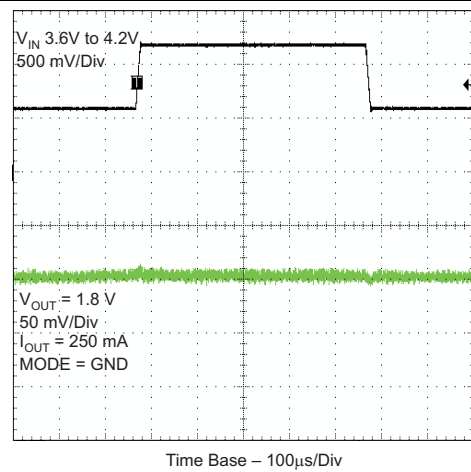

Figure 27. PWM Line Transient

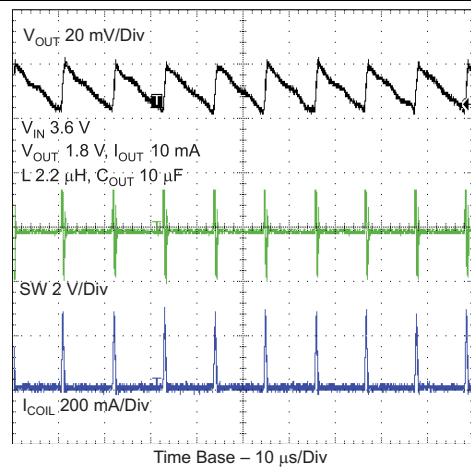

Figure 28. Typical Operation - PFM Mode

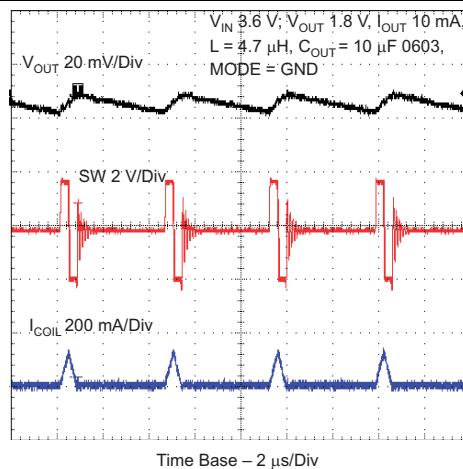

Figure 29. Typical Operation - PFM Mode

9.3 System Examples

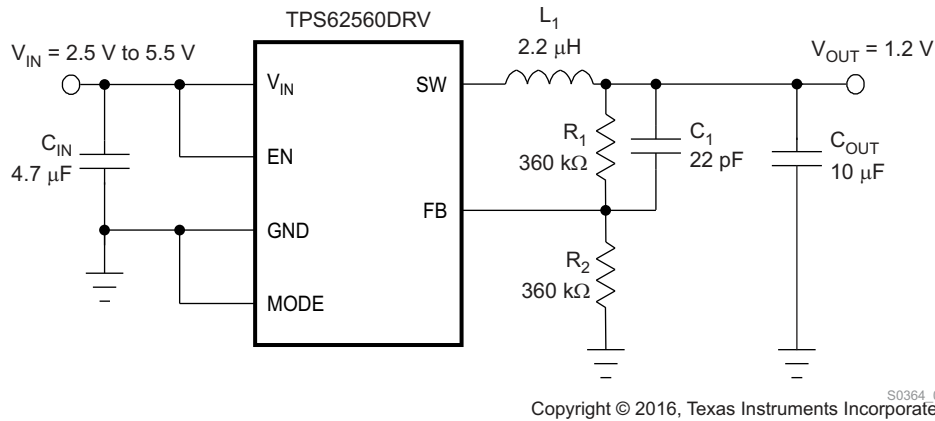

Figure 30. TPS62560 Adjustable 1.2-V Output

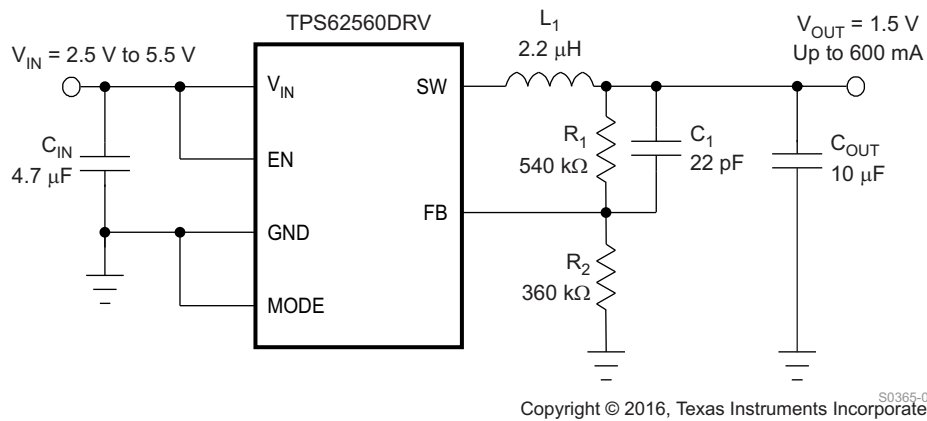

Figure 31. TPS62560 Adjustable 1.5-V Output

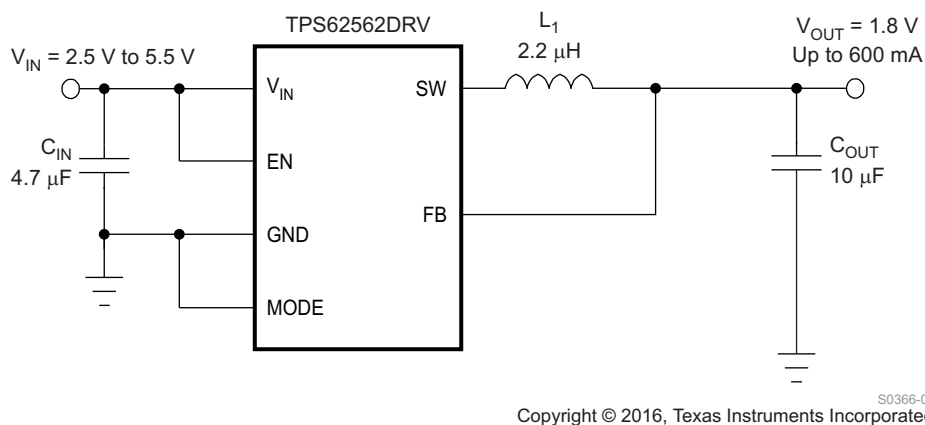

Figure 32. TPS62562 Fixed 1.8-V Output

10 Power Supply Recommendations

The TPS6226x device has no special requirements for its input power supply. The input power supply output current must be rated according to the supply voltage, output voltage, and output current of the TPS6226x.

11 Layout

11.1 Layout Guidelines

As for all switching power supplies, the layout is an important step in the design. Proper function of the device demands careful attention to PCB layout. Take care in board layout to get the specified performance. If the layout is not carefully done, the regulator could show poor line and/or load regulation, stability issues as well as EMI problems. It is critical to provide a low inductance, impedance ground path. Therefore, use wide and short traces for the main current paths. The input capacitor should be placed as close as possible to the IC pins as well as the inductor and output capacitor.

Connect the GND pin of the device to the exposed thermal pad of the PCB and use this pad as a star point. Use a common power GND node and a different node for the signal GND to minimize the effects of ground noise. Connect these ground nodes together to the exposed thermal pad (star point) underneath the IC. Keep the common path to the GND pin, which returns the small signal components and the high current of the output capacitors as short as possible to avoid ground noise. The FB line should be connected right to the output capacitor and routed away from noisy components and traces (for example, the SW line).

11.2 Layout Examples

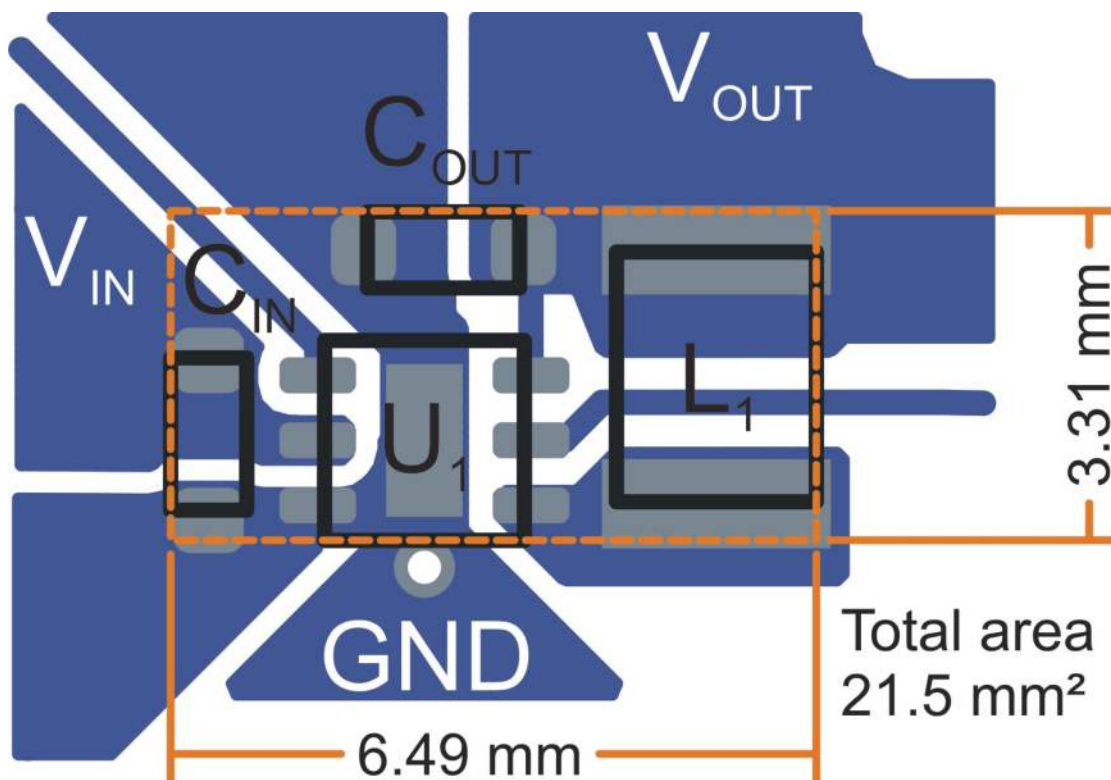

Figure 33. Suggested Layout for Fixed-Output-Voltage Options

Layout Examples (continued)

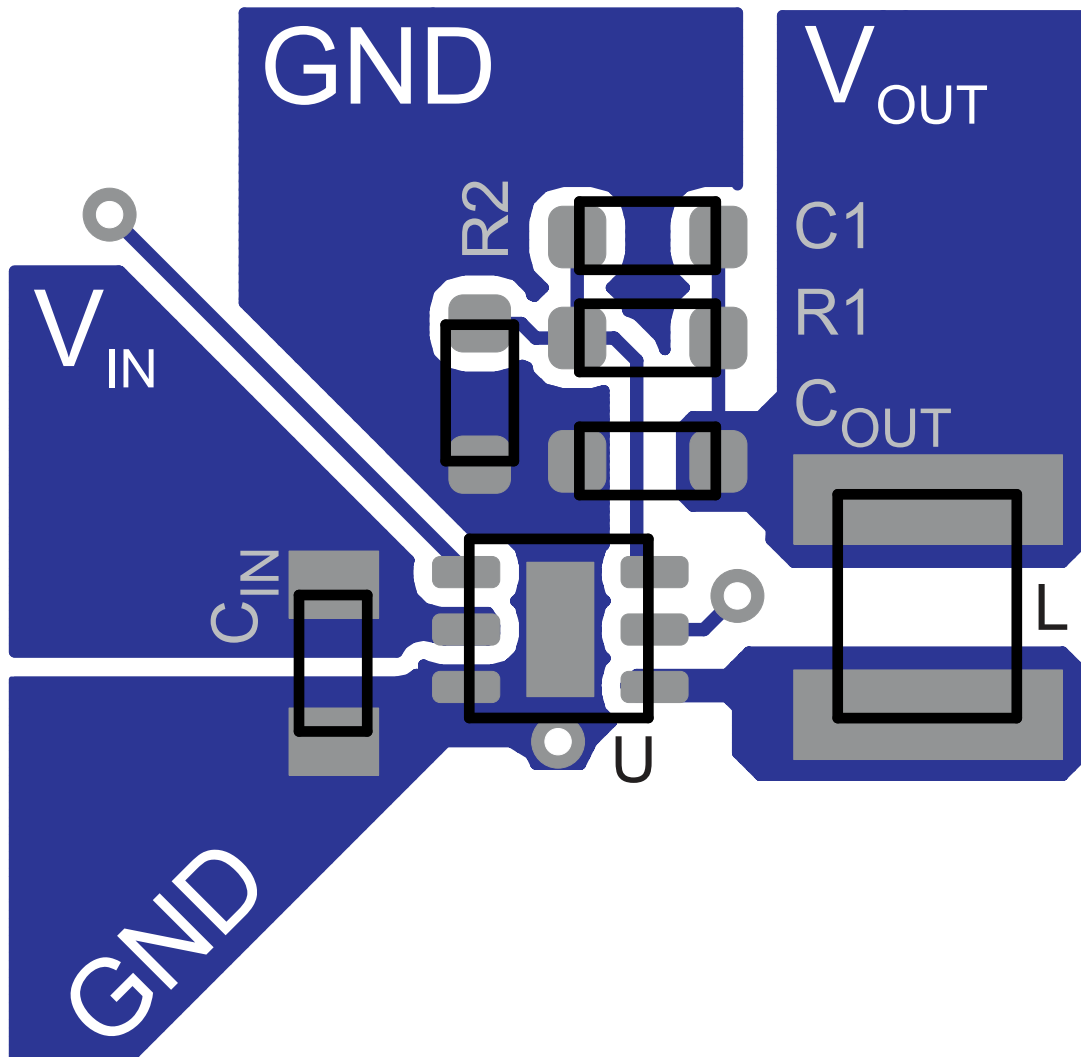

Figure 34. Suggested Layout for Adjustable-Output-Voltage Version

12 Device and Documentation Support

12.1 Device Support

12.1.1 Third-Party Products Disclaimer

TI'S PUBLICATION OF INFORMATION REGARDING THIRD-PARTY PRODUCTS OR SERVICES DOES NOT CONSTITUTE AN ENDORSEMENT REGARDING THE SUITABILITY OF SUCH PRODUCTS OR SERVICES OR A WARRANTY, REPRESENTATION OR ENDORSEMENT OF SUCH PRODUCTS OR SERVICES, EITHER ALONE OR IN COMBINATION WITH ANY TI PRODUCT OR SERVICE.

12.2 Related Links

The table below lists quick access links. Categories include technical documents, support and community resources, tools and software, and quick access to sample or buy.

Table 3. Related Links

PARTS	PRODUCT FOLDER	SAMPLE & BUY	TECHNICAL DOCUMENTS	TOOLS & SOFTWARE	SUPPORT & COMMUNITY
TPS62560	Click here	Click here	Click here	Click here	Click here
TPS62561	Click here	Click here	Click here	Click here	Click here
TPS62562	Click here	Click here	Click here	Click here	Click here

12.3 Receiving Notification of Documentation Updates

To receive notification of documentation updates, navigate to the device product folder on ti.com. In the upper right corner, click on *Alert me* to register and receive a weekly digest of any product information that has changed. For change details, review the revision history included in any revised document.

12.4 Community Resources

The following links connect to TI community resources. Linked contents are provided "AS IS" by the respective contributors. They do not constitute TI specifications and do not necessarily reflect TI's views; see TI's [Terms of Use](#).

TI E2E™ Online Community *TI's Engineer-to-Engineer (E2E) Community*. Created to foster collaboration among engineers. At e2e.ti.com, you can ask questions, share knowledge, explore ideas and help solve problems with fellow engineers.

Design Support *TI's Design Support* Quickly find helpful E2E forums along with design support tools and contact information for technical support.

12.5 Trademarks

E2E is a trademark of Texas Instruments.
All other trademarks are the property of their respective owners.

12.6 Electrostatic Discharge Caution



These devices have limited built-in ESD protection. The leads should be shorted together or the device placed in conductive foam during storage or handling to prevent electrostatic damage to the MOS gates.

12.7 Glossary

SLYZ022 — *TI Glossary*.

This glossary lists and explains terms, acronyms, and definitions.

13 Mechanical, Packaging, and Orderable Information

The following pages include mechanical, packaging, and orderable information. This information is the most current data available for the designated devices. This data is subject to change without notice and revision of this document. For browser-based versions of this data sheet, refer to the left-hand navigation.

PACKAGING INFORMATION

Orderable Device	Status (1)	Package Type	Package Drawing	Pins	Package Qty	Eco Plan (2)	Lead finish/ Ball material (6)	MSL Peak Temp (3)	Op Temp (°C)	Device Marking (4/5)	Samples
TPS62560DRVR	ACTIVE	WSON	DRV	6	3000	RoHS & Green	NIPDAU	Level-1-260C-UNLIM	-40 to 85	CEY	Samples
TPS62560DRVT	ACTIVE	WSON	DRV	6	250	RoHS & Green	NIPDAU	Level-1-260C-UNLIM	-40 to 85	CEY	Samples
TPS62561DDCR	ACTIVE	SOT-23-THIN	DDC	5	3000	RoHS & Green	NIPDAU	Level-1-260C-UNLIM	-40 to 85	CVO	Samples
TPS62561DDCT	ACTIVE	SOT-23-THIN	DDC	5	250	RoHS & Green	NIPDAU	Level-1-260C-UNLIM	-40 to 85	CVO	Samples
TPS62562DRVR	ACTIVE	WSON	DRV	6	3000	RoHS & Green	NIPDAU	Level-1-260C-UNLIM	-40 to 85	NXT	Samples
TPS62562DRVT	ACTIVE	WSON	DRV	6	250	RoHS & Green	NIPDAU	Level-1-260C-UNLIM	-40 to 85	NXT	Samples

(1) The marketing status values are defined as follows:

ACTIVE: Product device recommended for new designs.

LIFEBUY: TI has announced that the device will be discontinued, and a lifetime-buy period is in effect.

NRND: Not recommended for new designs. Device is in production to support existing customers, but TI does not recommend using this part in a new design.

PREVIEW: Device has been announced but is not in production. Samples may or may not be available.

OBSOLETE: TI has discontinued the production of the device.

(2) **RoHS:** TI defines "RoHS" to mean semiconductor products that are compliant with the current EU RoHS requirements for all 10 RoHS substances, including the requirement that RoHS substance do not exceed 0.1% by weight in homogeneous materials. Where designed to be soldered at high temperatures, "RoHS" products are suitable for use in specified lead-free processes. TI may reference these types of products as "Pb-Free".

RoHS Exempt: TI defines "RoHS Exempt" to mean products that contain lead but are compliant with EU RoHS pursuant to a specific EU RoHS exemption.

Green: TI defines "Green" to mean the content of Chlorine (Cl) and Bromine (Br) based flame retardants meet JS709B low halogen requirements of <=1000ppm threshold. Antimony trioxide based flame retardants must also meet the <=1000ppm threshold requirement.

(3) MSL, Peak Temp. - The Moisture Sensitivity Level rating according to the JEDEC industry standard classifications, and peak solder temperature.

(4) There may be additional marking, which relates to the logo, the lot trace code information, or the environmental category on the device.

(5) Multiple Device Markings will be inside parentheses. Only one Device Marking contained in parentheses and separated by a "~" will appear on a device. If a line is indented then it is a continuation of the previous line and the two combined represent the entire Device Marking for that device.

(6) Lead finish/Ball material - Orderable Devices may have multiple material finish options. Finish options are separated by a vertical ruled line. Lead finish/Ball material values may wrap to two lines if the finish value exceeds the maximum column width.

Important Information and Disclaimer: The information provided on this page represents TI's knowledge and belief as of the date that it is provided. TI bases its knowledge and belief on information provided by third parties, and makes no representation or warranty as to the accuracy of such information. Efforts are underway to better integrate information from third parties. TI has taken and continues to take reasonable steps to provide representative and accurate information but may not have conducted destructive testing or chemical analysis on incoming materials and chemicals. TI and TI suppliers consider certain information to be proprietary, and thus CAS numbers and other limited information may not be available for release.

In no event shall TI's liability arising out of such information exceed the total purchase price of the TI part(s) at issue in this document sold by TI to Customer on an annual basis.

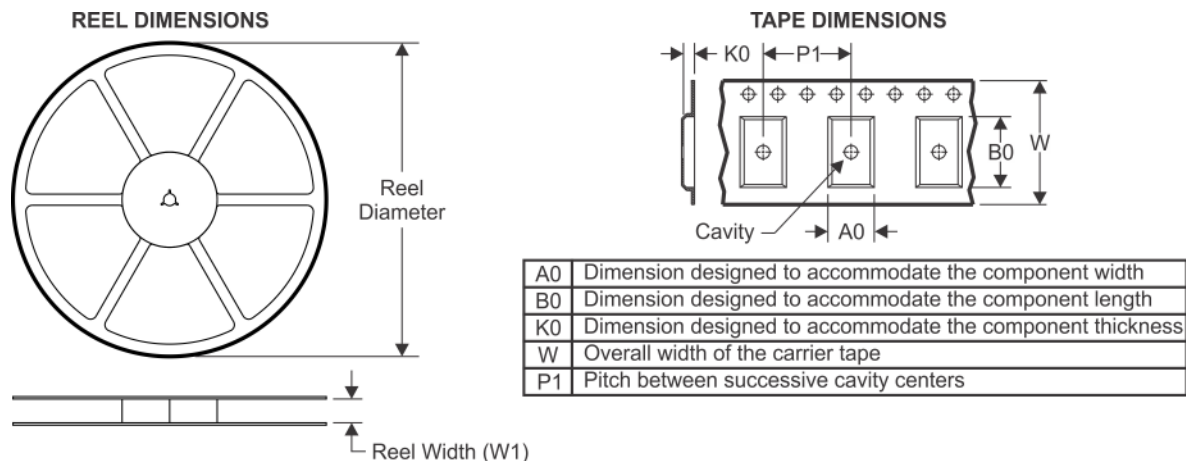
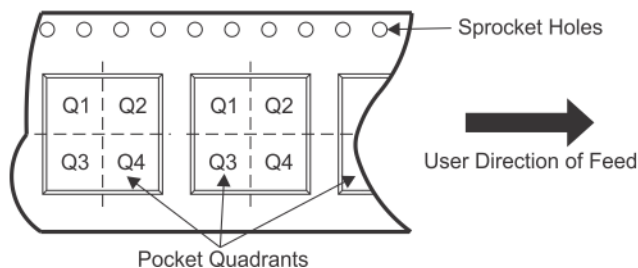
TAPE AND REEL INFORMATION

QUADRANT ASSIGNMENTS FOR PIN 1 ORIENTATION IN TAPE

*All dimensions are nominal

Device	Package Type	Package Drawing	Pins	SPQ	Reel Diameter (mm)	Reel Width W1 (mm)	A0 (mm)	B0 (mm)	K0 (mm)	P1 (mm)	W (mm)	Pin1 Quadrant
TPS62560DRVR	WSON	DRV	6	3000	179.0	8.4	2.2	2.2	1.2	4.0	8.0	Q2
TPS62560DRVT	WSON	DRV	6	250	179.0	8.4	2.2	2.2	1.2	4.0	8.0	Q2
TPS62561DDCR	SOT-23-THIN	DDC	5	3000	179.0	8.4	3.2	3.2	1.4	4.0	8.0	Q3
TPS62561DDCT	SOT-23-THIN	DDC	5	250	179.0	8.4	3.2	3.2	1.4	4.0	8.0	Q3
TPS62562DRVR	WSON	DRV	6	3000	179.0	8.4	2.2	2.2	1.2	4.0	8.0	Q2
TPS62562DRVT	WSON	DRV	6	250	179.0	8.4	2.2	2.2	1.2	4.0	8.0	Q2

TAPE AND REEL BOX DIMENSIONS

*All dimensions are nominal

Device	Package Type	Package Drawing	Pins	SPQ	Length (mm)	Width (mm)	Height (mm)
TPS62560DRVR	WSON	DRV	6	3000	200.0	183.0	25.0
TPS62560DRVT	WSON	DRV	6	250	200.0	183.0	25.0
TPS62561DDCR	SOT-23-THIN	DDC	5	3000	200.0	183.0	25.0
TPS62561DDCT	SOT-23-THIN	DDC	5	250	200.0	183.0	25.0
TPS62562DRVR	WSON	DRV	6	3000	200.0	183.0	25.0
TPS62562DRVT	WSON	DRV	6	250	200.0	183.0	25.0

GENERIC PACKAGE VIEW

DRV 6

WSO - 0.8 mm max height

PLASTIC SMALL OUTLINE - NO LEAD

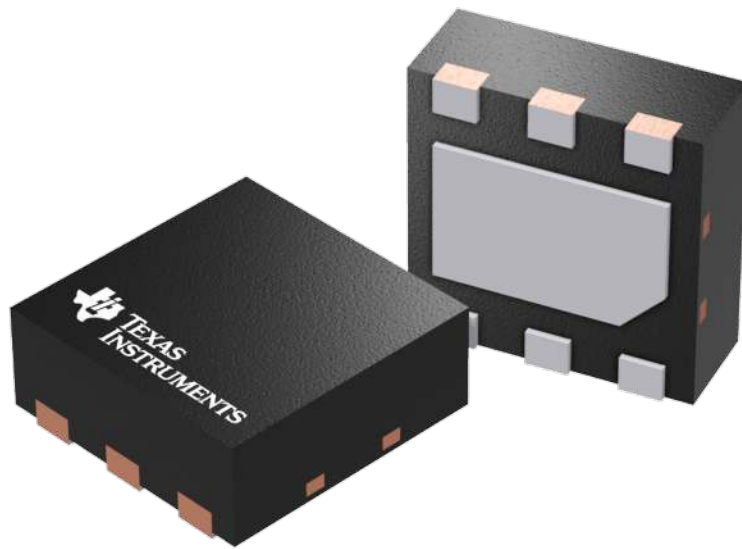

Images above are just a representation of the package family, actual package may vary.
Refer to the product data sheet for package details.

4206925/F

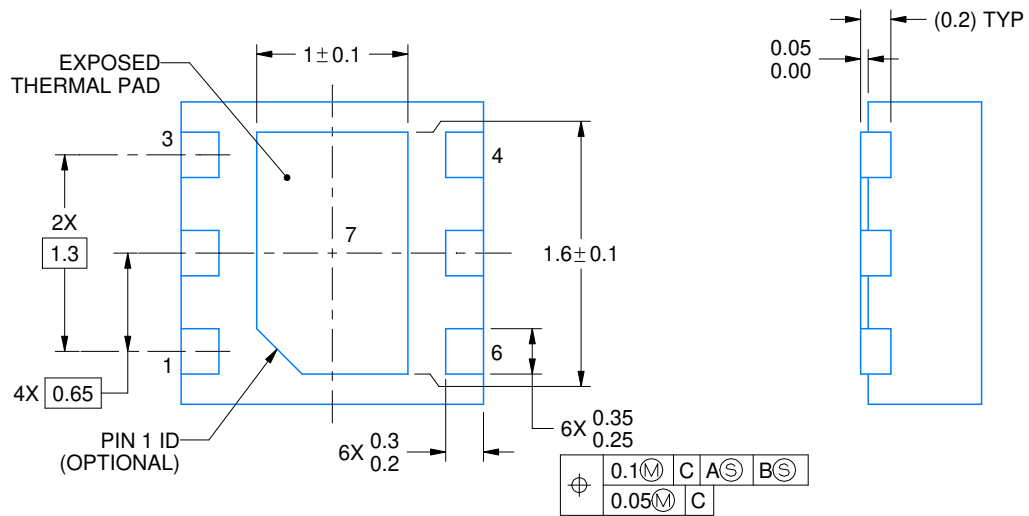
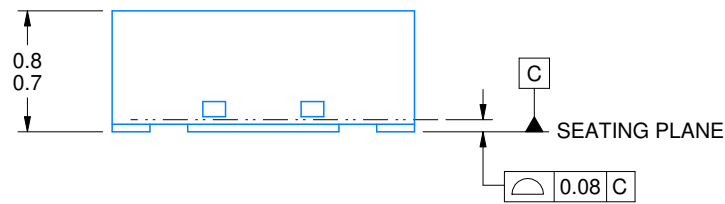
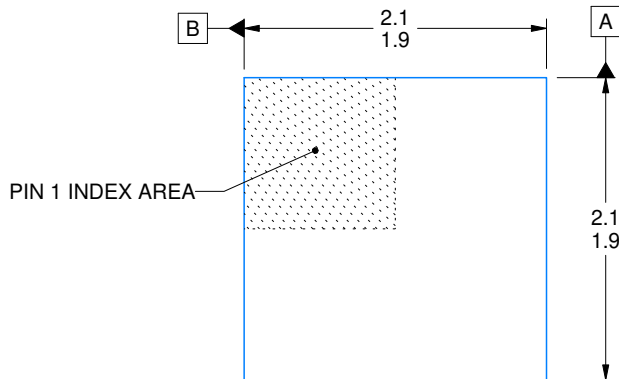
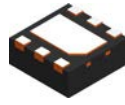

4222173/B 04/2018

NOTES:

1. All linear dimensions are in millimeters. Any dimensions in parenthesis are for reference only. Dimensioning and tolerancing per ASME Y14.5M.
2. This drawing is subject to change without notice.
3. The package thermal pad must be soldered to the printed circuit board for thermal and mechanical performance.

EXAMPLE STENCIL DESIGN

DRV0006A

WSON - 0.8 mm max height

PLASTIC SMALL OUTLINE - NO LEAD

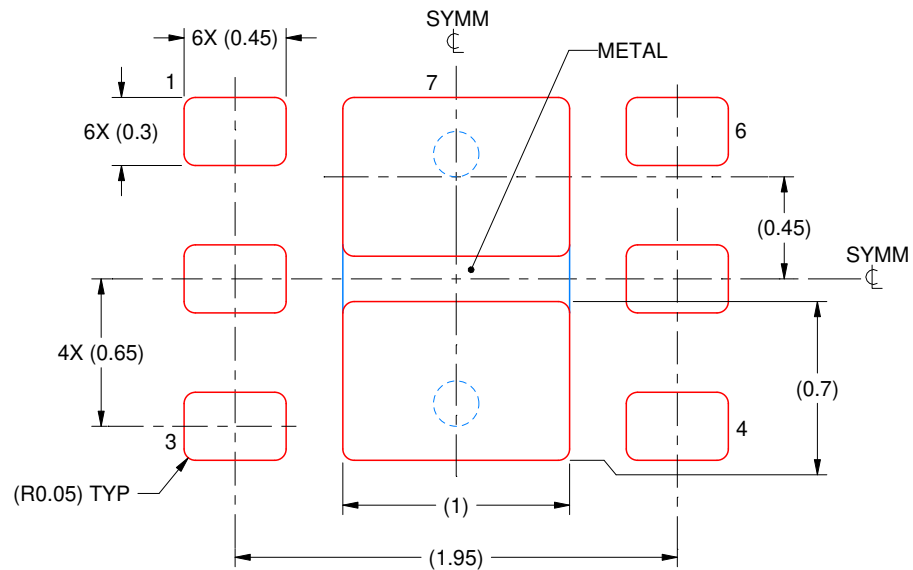

SOLDER PASTE EXAMPLE
BASED ON 0.125 mm THICK STENCIL

EXPOSED PAD #7
88% PRINTED SOLDER COVERAGE BY AREA UNDER PACKAGE
SCALE:30X

4222173/B 04/2018

NOTES: (continued)

6. Laser cutting apertures with trapezoidal walls and rounded corners may offer better paste release. IPC-7525 may have alternate design recommendations.

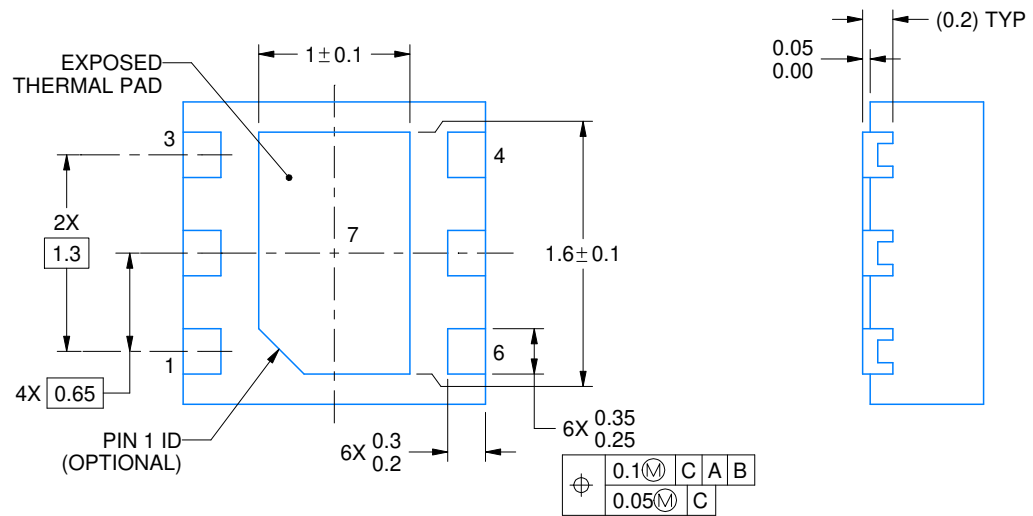
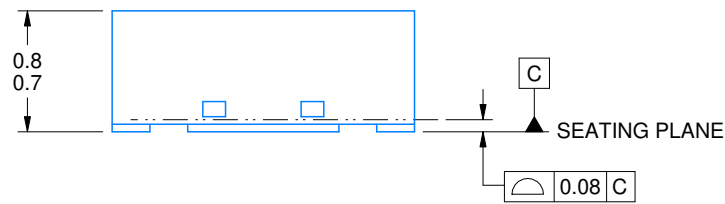
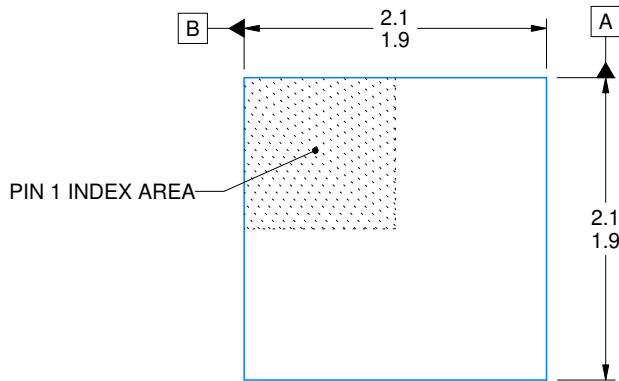

4225563/A 12/2019

NOTES:

1. All linear dimensions are in millimeters. Any dimensions in parenthesis are for reference only. Dimensioning and tolerancing per ASME Y14.5M.
2. This drawing is subject to change without notice.
3. The package thermal pad must be soldered to the printed circuit board for thermal and mechanical performance.

EXAMPLE BOARD LAYOUT

DRV0006D

WSON - 0.8 mm max height

PLASTIC SMALL OUTLINE - NO LEAD

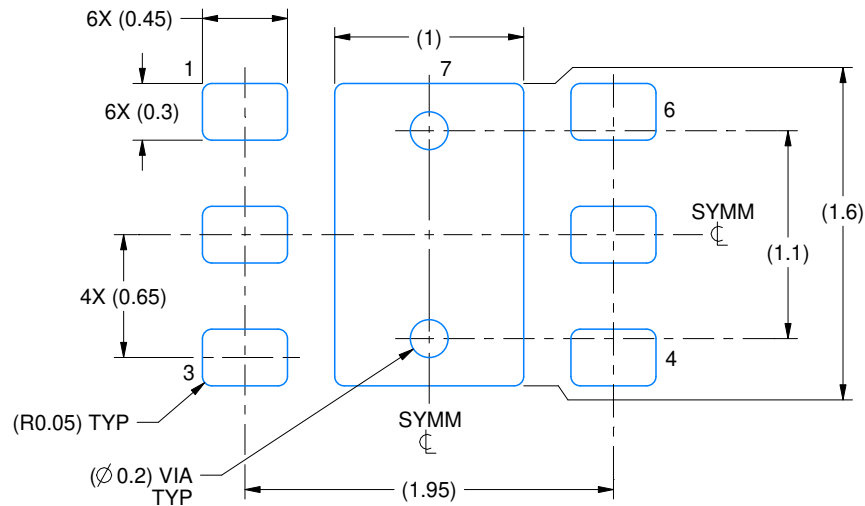

LAND PATTERN EXAMPLE
EXPOSED METAL SHOWN
SCALE:25X

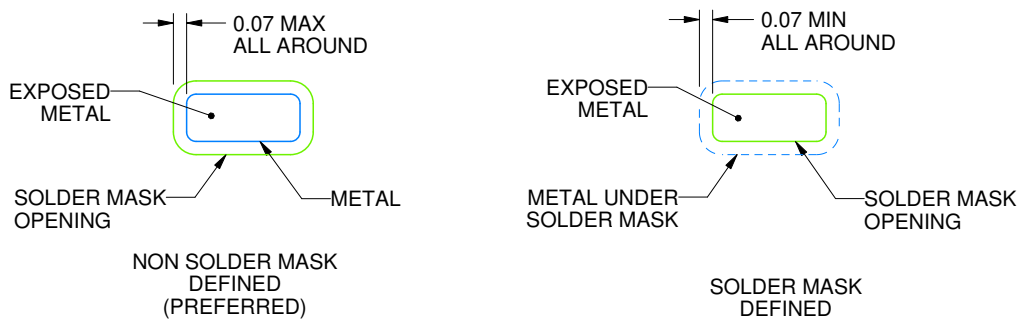

SOLDER MASK DETAILS

4225563/A 12/2019

NOTES: (continued)

- This package is designed to be soldered to a thermal pad on the board. For more information, see Texas Instruments literature number SLUA271 (www.ti.com/lit/sluea271).
- Vias are optional depending on application, refer to device data sheet. If some or all are implemented, recommended via locations are shown.

EXAMPLE STENCIL DESIGN

DRV0006D

WSON - 0.8 mm max height

PLASTIC SMALL OUTLINE - NO LEAD

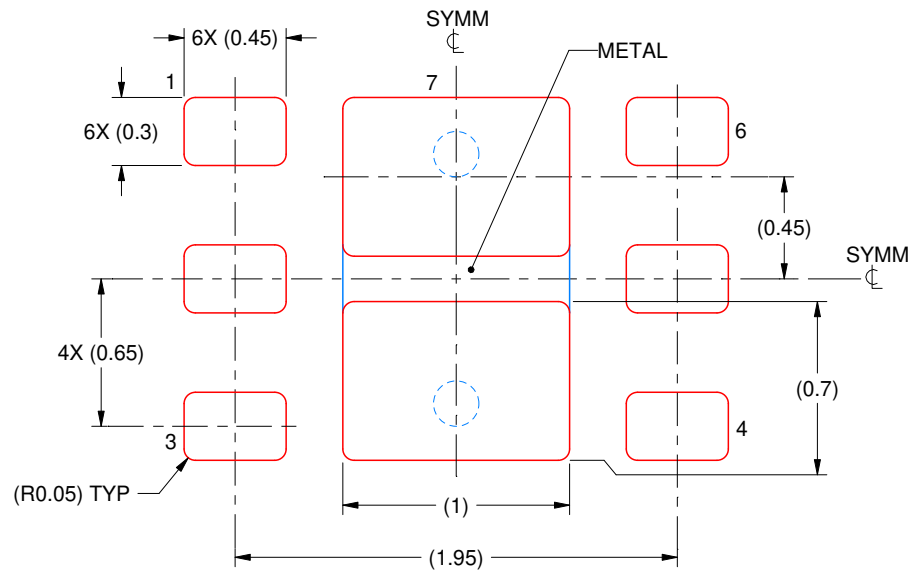

SOLDER PASTE EXAMPLE
BASED ON 0.125 mm THICK STENCIL

EXPOSED PAD #7
88% PRINTED SOLDER COVERAGE BY AREA UNDER PACKAGE
SCALE:30X

4225563/A 12/2019

NOTES: (continued)

6. Laser cutting apertures with trapezoidal walls and rounded corners may offer better paste release. IPC-7525 may have alternate design recommendations.

EXAMPLE BOARD LAYOUT

DDC0005A

SOT-23 - 1.1 max height

SMALL OUTLINE TRANSISTOR

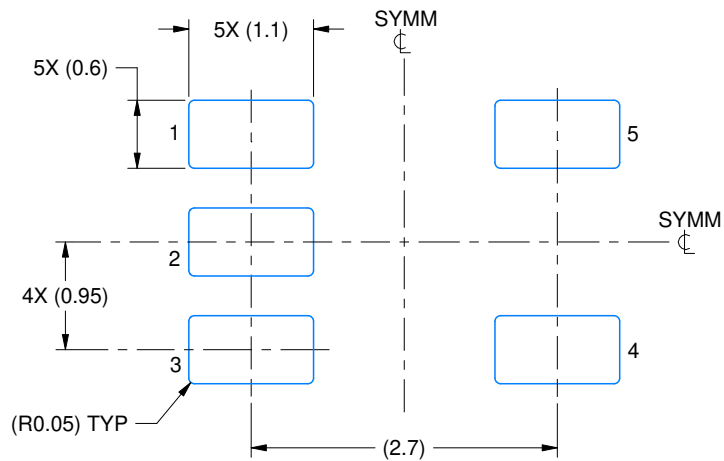

LAND PATTERN EXAMPLE
EXPLODED METAL SHOWN
SCALE:15X

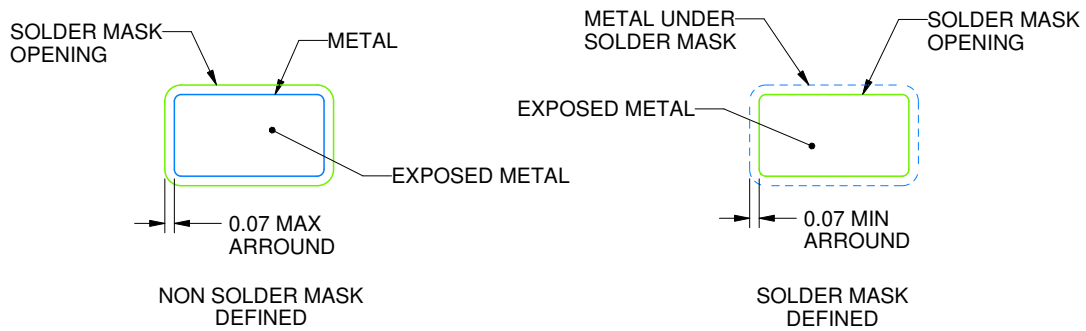

SOLDERMASK DETAILS

4220752/A 03/2023

NOTES: (continued)

- 4. Publication IPC-7351 may have alternate designs.
- 5. Solder mask tolerances between and around signal pads can vary based on board fabrication site.

EXAMPLE STENCIL DESIGN

DDC0005A

SOT-23 - 1.1 max height

SMALL OUTLINE TRANSISTOR

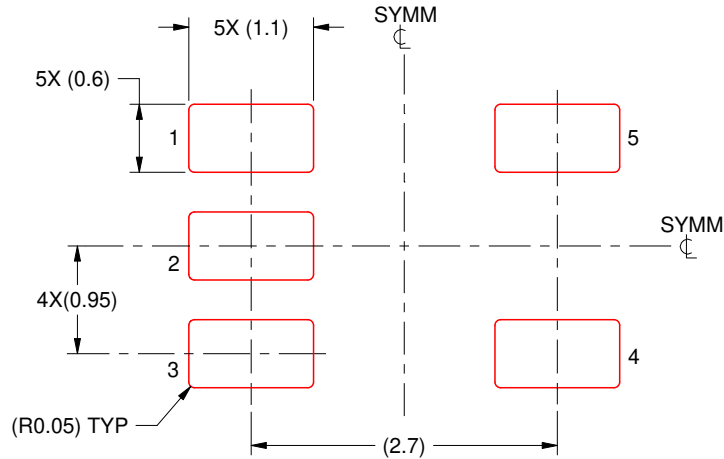

SOLDER PASTE EXAMPLE
BASED ON 0.125 THICK STENCIL
SCALE:15X

4220752/A 03/2023

NOTES: (continued)

6. Laser cutting apertures with trapezoidal walls and rounded corners may offer better paste release. IPC-7525 may have alternate design recommendations.
7. Board assembly site may have different recommendations for stencil design.

IMPORTANT NOTICE AND DISCLAIMER

TI PROVIDES TECHNICAL AND RELIABILITY DATA (INCLUDING DATA SHEETS), DESIGN RESOURCES (INCLUDING REFERENCE DESIGNS), APPLICATION OR OTHER DESIGN ADVICE, WEB TOOLS, SAFETY INFORMATION, AND OTHER RESOURCES "AS IS" AND WITH ALL FAULTS, AND DISCLAIMS ALL WARRANTIES, EXPRESS AND IMPLIED, INCLUDING WITHOUT LIMITATION ANY IMPLIED WARRANTIES OF MERCHANTABILITY, FITNESS FOR A PARTICULAR PURPOSE OR NON-INFRINGEMENT OF THIRD PARTY INTELLECTUAL PROPERTY RIGHTS.

These resources are intended for skilled developers designing with TI products. You are solely responsible for (1) selecting the appropriate TI products for your application, (2) designing, validating and testing your application, and (3) ensuring your application meets applicable standards, and any other safety, security, regulatory or other requirements.

These resources are subject to change without notice. TI grants you permission to use these resources only for development of an application that uses the TI products described in the resource. Other reproduction and display of these resources is prohibited. No license is granted to any other TI intellectual property right or to any third party intellectual property right. TI disclaims responsibility for, and you will fully indemnify TI and its representatives against, any claims, damages, costs, losses, and liabilities arising out of your use of these resources.

TI's products are provided subject to [TI's Terms of Sale](#) or other applicable terms available either on [ti.com](https://www.ti.com) or provided in conjunction with such TI products. TI's provision of these resources does not expand or otherwise alter TI's applicable warranties or warranty disclaimers for TI products.

TI objects to and rejects any additional or different terms you may have proposed.

Mailing Address: Texas Instruments, Post Office Box 655303, Dallas, Texas 75265
Copyright © 2023, Texas Instruments Incorporated