

## Middle Power LED Series 3030

# LM302C

## CRI 90



### Features & Benefits

- Superior mid power LED with wide over-drive range up to 0.6W
- Mold resin for high reliability
- Standard form factor for design flexibility (3.0 × 3.0 mm)

**Table of Contents**

1.	Characteristics	-----	3
2.	Product Code Information	-----	5
3.	Typical Characteristics Graphs	-----	12
4.	Outline Drawing & Dimension	-----	15
5.	Reliability Test Items & Conditions	-----	16
6.	Soldering Conditions	-----	17
7.	Tape & Reel	-----	18
8.	Label Structure	-----	20
9.	Packing Structure	-----	21
10.	Precautions in Handling & Use	-----	24

**1. Characteristics**

## a) Absolute Maximum Rating

Item	Symbol	Rating	Unit	Condition
Ambient / Operating Temperature	$T_a$	-40 ~ +85	°C	-
Storage Temperature	$T_{stg}$	-40 ~ +100	°C	-
LED Junction Temperature	$T_j$	110	°C	-
Forward Current	$I_F$	150	mA	-
Assembly Process Temperature	-	260 <10	°C s	-
ESD (HBM)	-	5	kV	-

## b) Electro-optical Characteristics ( $I_F = 65 \text{ mA}$ , $T_s = 25 \text{ °C}$ )

Item	Unit	Rank	Bin	Min.	Typ.	Max.
Forward Voltage ( $V_f$ )	V	YB	AY	5.4	-	5.6
			AZ	5.6	-	5.8
			A1	5.8	-	6.0
			A2	6.0	-	6.2
			A3	6.2	-	6.4
Reverse Voltage (@ 5 mA)	V			0.7	-	1.2
Color Rendering Index ( $R_a$ )	-			90	-	-
Thermal Resistance (junction to solder point)	°C/W			-	8	-
Beam Angle	°			-	115	-

### Note:

Samsung maintains measurement tolerance of: forward voltage =  $\pm 0.1 \text{ V}$ , CRI =  $\pm 3$

c) Electro-optical Characteristics ( $I_F = 65 \text{ mA}$ ,  $T_s = 25 \text{ }^\circ\text{C}$ )

Item	CRI	Nominal	SB		SC		SD		SE		SF		Current
		CCT (K)	Min.	Min.	Min.	Min.	Max.	Max.	Min.	Max.	Min.	Max.	
		2700	46	50	50	54	54	58	58	62	62	66	65mA
Luminous Flux ( $\Phi_v$ )	90	3000											
		3500											
		4000											
		5000											
		5700											
		6500											

**Note:**

Samsung maintains measurement tolerance of: forward voltage =  $\pm 0.1\text{V}$ , luminous flux =  $\pm 5\%$ , CRI =  $\pm 3$

## 2. Product Code Information

1	2	3	4	5	6	7	8	9	10	11	12	13	14	15	16	17	18
S	P	M	W	H	T	3	2	B	M	D	7	Y	B	R	0	S	0

Digit	PKG Information	Code	Specification
1 2 3	Samsung Package Middle Power	SPM	
4 5	Color	WH	White
6	Product Version	T	
7 8 9	Form Factor	32B	3.0 x 3.0 x 0.7 mm; 2 pads; 1chip;
10	Sorting Current (mA)	M	65 mA
11	Chromaticity Coordinates	D	ANSI Standard
12	CRI	7	Min. 90
			AY : 5.4 ~ 5.6V
			AZ : 5.6 ~ 5.8V
13 14	Forward Voltage (V)	YB	5.4~6.4V Bin Code: A1 : 5.8 ~ 6.0V A2 : 6.0 ~ 6.2V A3 : 6.2 ~ 6.4V
		W●	2700K WA, WB, WC, WD, WE, WF, WG, WH, WJ, WK, WL, WM
		V●	3000K VA, VB, VC, VD, VE, VF, VG, VH, VJ, VK, VL, VM
		U●	3500K UA, UB, UC, UD, UE, UF, UG, UH, UJ, UK, UL, UM
15 16	CCT (K)	T●	4000K TA, TB, TC, TD, TE, TF, TG, TH, TJ, TK, TL, TM
		R●	5000K RA, RB, RC, RD, RE, RF, RG, RH, RJ, RK, RL, RM
		Q●	5700K QA, QB, QC, QD, QE, QF, QG, QH, QJ, QK, QL, QM
		P●	6500K PA, PB, PC, PD, PE, PF, PG, PH, PJ, PK, PL, PM
		●	: "0" (Whole bin) or "K" (K Kitting) or "S" (S Kitting)
17 18	Luminous Flux	S0	Bin Code: SB, SC, SD, SE, SF

a) Luminous Flux Bins ( $I_F = 65 \text{ mA}$ ,  $T_s = 25^\circ\text{C}$ )

CRI ( $R_a$ ) Min.	Nominal CCT (K)	Product Code	Flux Bin	Flux Range ( $\Phi_v$ , lm)
90	2700	SPMWHT32BMD7YBW●S0	SB	46 ~ 50
			SC	50 ~ 54
			SD	54 ~ 58
	3000	SPMWHT32BMD7YBV●S0	SC	50 ~ 54
			SD	54 ~ 58
			SE	58 ~ 62
	3500	SPMWHT32BMD7YBU●S0	SC	50 ~ 54
			SD	54 ~ 58
			SE	58 ~ 62
	4000	SPMWHT32BMD7YBT●S0	SD	54 ~ 58
			SE	58 ~ 62
			SF	62 ~ 66
	5000	SPMWHT32BMD7YBR●S0	SD	54 ~ 58
			SE	58 ~ 62
			SF	62 ~ 66
	5700	SPMWHT32BMD7YBQ●S0	SD	54 ~ 58
			SE	58 ~ 62
			SF	62 ~ 66
	6500	SPMWHT32BMD7YBP●S0	SD	54 ~ 58
			SE	58 ~ 62
			SF	62 ~ 66

**Note:**

"●" can be "0" (Whole bin), "K" (K Kitting) or "S" (S Kitting) of the color binning

**b) Kitting Rule**

**1) S Kitting Bin Concept**

1. Under agreement between customer and SAMSUNG ELECTRONICS, SAMSUNG can supply kitting bin (VF, Color, Im).
2. A forward voltage (VF) of kitting bin is combined by a pair of same VF rank such as (AY+AY), (AZ+AZ), (A1+A1), (A2+A2) or (A3+A3)
3. A Chromaticity Coordinates of kitting bin is mixed by kitting procedure.(below kitting simulation)
4. A luminous flux(lm) of kitting bin is combined by a pair of IV rank such as (SB+SB), (SB+SC), (SC+SC), (SC+SD), (SD+SD), (SD+SE) or (SE+SE)

**[Kitting example]**

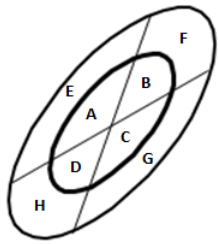

**[Binning Information]**

Item	Bin #1	Bin #2
VF	AY	AY
	AZ	AZ
	A1	A1
	A2	A2
	A3	A3
CIE	A	G
	C	E
	D	F
	B	H
	E	G
	F	H
	MacA. 3step(A, B, C, D)	MacA. 3step(A, B, C, D)
IV	SB	SB
	SB	SC
	SC	SC
	SC	SD
	SD	SD
	SD	SE
	SE	SE
	SE	SF
	SF	SF

## 2) K Kitting Bin Concept

1. Under agreement between customer and SAMSUNG ELECTRONICS, SAMSUNG can supply kitting bin (VF, Color, Im).
2. A forward voltage (VF) of kitting bin is combined by a pair of same VF rank such as (AY+AY), (AZ+AZ), (A1+A1), (A2+A2) or (A3+A3)
3. A Chromaticity Coordinates of kitting bin is mixed by kitting procedure.(below kitting simulation)
4. A luminous flux(lm) of kitting bin is combined by a pair of IV rank such as (SB+SB), (SB+SC), (SC+SC), (SC+SD), (SD+SD), (SD+SE) or (SE+SE)

### [Kitting example]

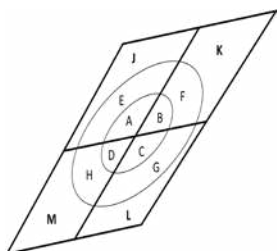

### [Binning Information]

Item	Bin #1	Bin #2
VF	AY	AY
	AZ	AZ
	A1	A1
	A2	A2
	A3	A3
CIE	H	K
	F	M
	E	L
	G	J
	E	G
	F	H
IV	MacA. 3step(A, B, C, D)	MacA. 3step(A, B, C, D)
	SB	SB
	SB	SC
	SC	SC
	SC	SD
	SD	SD
	SD	SE
	SE	SE
	SE	SF
	SF	SF



c) Color Bins ( $I_F = 65 \text{ mA}$ ,  $T_s = 25 \text{ }^\circ\text{C}$ )

CRI ( $R_a$ ) Min.	Nominal CCT (K)	Product Code	Color Rank	Chromaticity Bins
90	2700	SPMWHT32BMD7YBW0S0	W0 (Whole bin)	WA, WB, WC, WD, WE, WF, WG, WH, WJ, WK, WL, WM
		SPMWHT32BMD7YBWSS0	WS (S kitting bin)	WA, WB, WC, WD, WE, WF, WG, WH,
		SPMWHT32BMD7YBWKS0	WK (K kitting bin)	WA, WB, WC, WD, WE, WF, WG, WH, WJ, WK, WL, WM
	3000	SPMWHT32BMD7YBV0S0	V0 (Whole bin)	VA, VB, VC, VD, VE, VF, VG, VH, VJ, VK, VL, VM
		SPMWHT32BMD7YBVSS0	VS (S kitting bin)	VA, VB, VC, VD, VE, VF, VG, VH,
		SPMWHT32BMD7YBVKS0	VK (K kitting bin)	VA, VB, VC, VD, VE, VF, VG, VH, VJ, VK, VL, VM
	3500	SPMWHT32BMD7YBU0S0	U0 (Whole bin)	UA, UB, UC, UD, UE, UF, UG, UH, UJ, UK, UL, UM
		SPMWHT32BMD7YBUSS0	US (S kitting bin)	UA, UB, UC, UD, UE, UF, UG, UH,
		SPMWHT32BMD7YBUKS0	UK (K kitting bin)	UA, UB, UC, UD, UE, UF, UG, UH, UJ, UK, UL, UM
	4000	SPMWHT32BMD7YBT0S0	T0 (Whole bin)	TA, TB, TC, TD, TE, TF, TG, TH, TJ, TK, TL, TM
		SPMWHT32BMD7YBTSS0	TS (S kitting bin)	TA, TB, TC, TD, TE, TF, TG, TH,
		SPMWHT32BMD7YBTKS0	TK (K kitting bin)	TA, TB, TC, TD, TE, TF, TG, TH, TJ, TK, TL, TM
	5000	SPMWHT32BMD7YBR0S0	R0 (Whole bin)	RA, RB, RC, RD, RE, RF, RG, RH, RJ, RK, RL, RM
		SPMWHT32BMD7YBRSS0	RS (S kitting bin)	RA, RB, RC, RD, RE, RF, RG, RH,
		SPMWHT32BMD7YBRKS0	RK (K kitting bin)	RA, RB, RC, RD, RE, RF, RG, RH, RJ, RK, RL, RM
	5700	SPMWHT32BMD7YBQ0S0	Q0 (Whole bin)	QA, QB, QC, QD, QE, QF, QG, QH, QJ, QK, QL, QM
		SPMWHT32BMD7YBQSS0	QS (S kitting bin)	QA, QB, QC, QD, QE, QF, QG, QH,
		SPMWHT32BMD7YBQKS0	QK (K kitting bin)	QA, QB, QC, QD, QE, QF, QG, QH, QJ, QK, QL, QM
	6500	SPMWHT32BMD7YBP0S0	P0 (Whole bin)	PA, PB, PC, PD, PE, PF, PG, PH, PJ, PK, PL, PM
		SPMWHT32BMD7YBPSS0	PS (S kitting bin)	PA, PB, PC, PD, PE, PF, PG, PH,
		SPMWHT32BMD7YBPKS0	PK (K kitting bin)	PA, PB, PC, PD, PE, PF, PG, PH, PJ, PK, PL, PM

d) Voltage Bins ( $I_F = 65 \text{ mA}$ ,  $T_s = 25 \text{ }^\circ\text{C}$ )

CRI ( $R_a$ ) Min.	Nominal CCT (K)	Product Code	Voltage Rank	Voltage Bin	Voltage Range (V)
-	-	-	YB	AY	5.4 ~ 5.6
-	-	-		AZ	5.6 ~ 5.8
-	-	-		A1	5.8 ~ 6.0
-	-	-		A2	6.0 ~ 6.2
-	-	-		A3	6.2 ~ 6.4
-	-	-		-	-

e) Chromaticity Region & Coordinates ( $I_F = 65 \text{ mA}$ ,  $T_s = 25 \text{ }^\circ\text{C}$ )

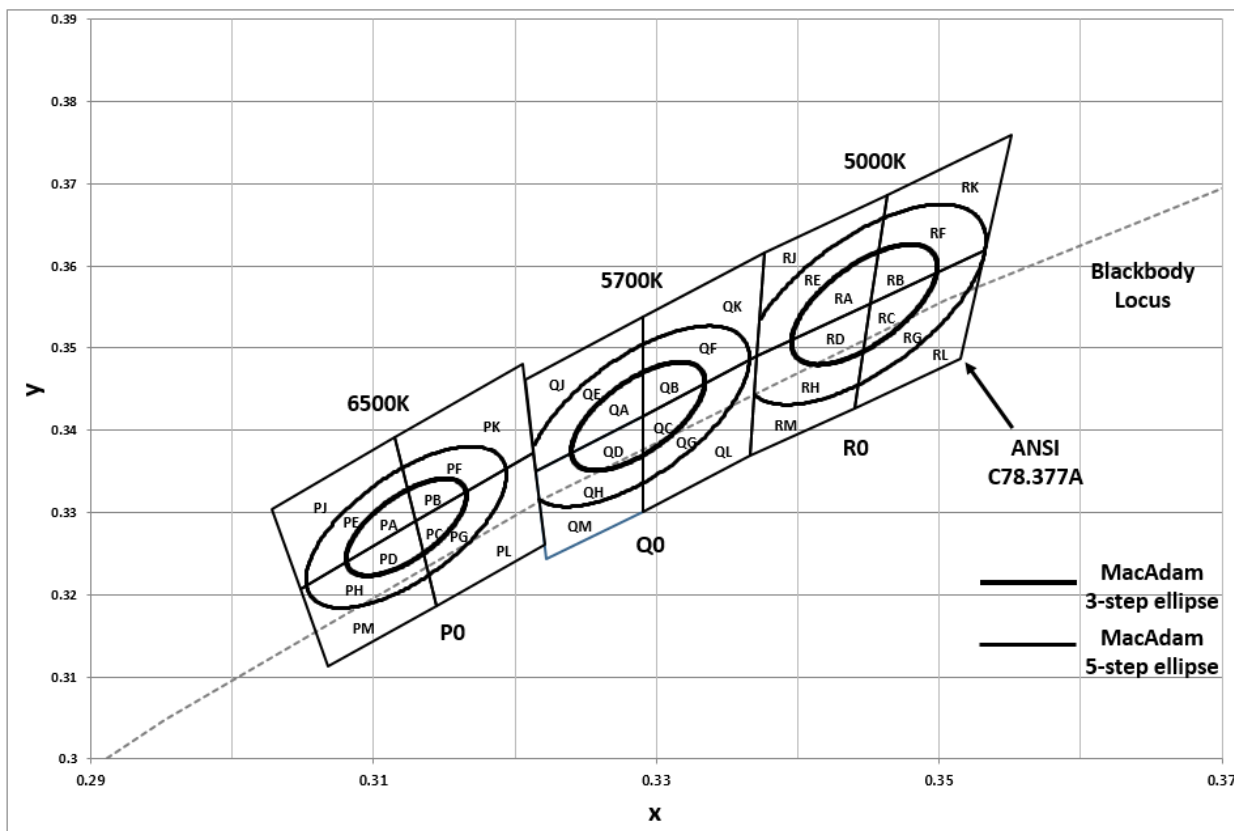
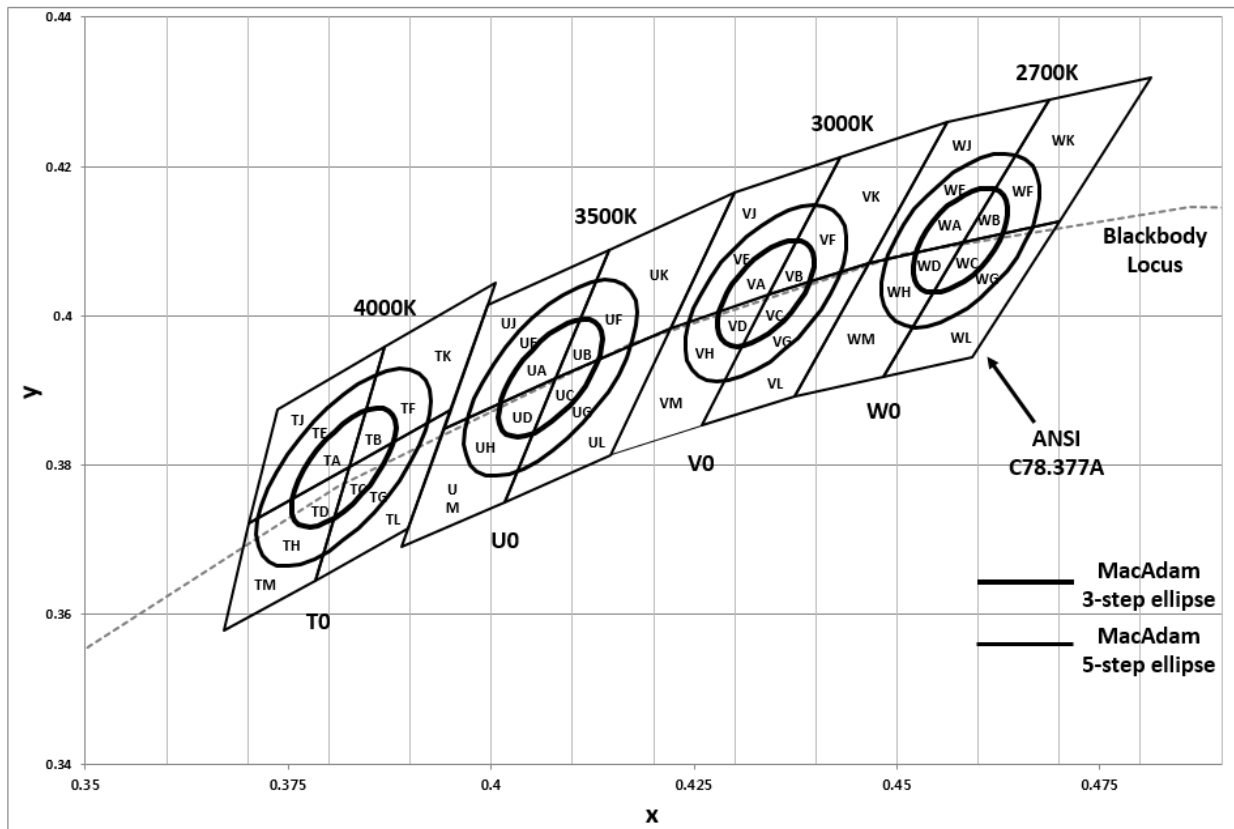

f) Chromaticity Region & Coordinates ( $I_F = 65 \text{ mA}$ ,  $T_s = 25 \text{ }^\circ\text{C}$ )

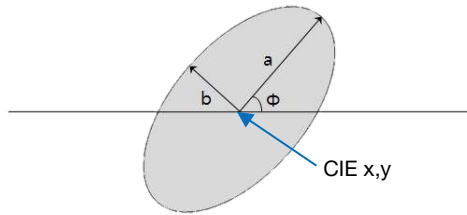

MacAdam Ellipse (W3, W5)					
Step	CIE x	CIE y	$\theta$	a	b
3-step	0.4578	0.4101	53.70	0.0081	0.0042
5-step	0.4578	0.4101	53.70	0.01350	0.00700

MacAdam Ellipse (V3, V5)					
Step	CIE x	CIE y	$\theta$	a	b
3-step	0.4338	0.4030	53.22	0.0083	0.0041
5-step	0.4338	0.4030	53.22	0.01390	0.00680

MacAdam Ellipse (U3, U5)					
Step	CIE x	CIE y	$\theta$	a	b
3-step	0.4073	0.3917	54.00	0.00927	0.00414
5-step	0.4073	0.3917	54.00	0.01545	0.00690

MacAdam Ellipse (T3, T5)					
Step	CIE x	CIE y	$\theta$	a	b
3-step	0.3818	0.3797	53.72	0.00939	0.00402
5-step	0.3818	0.3797	53.72	0.01565	0.00670

MacAdam Ellipse (R3, R5)					
Step	CIE x	CIE y	$\theta$	a	b
3-step	0.3447	0.3553	59.62	0.0082	0.0035
5-step	0.3447	0.3553	59.62	0.01370	0.00590

MacAdam Ellipse (Q3, Q5)					
Step	CIE x	CIE y	$\theta$	a	b
3-step	0.3287	0.3417	59.09	0.00746	0.00320
5-step	0.3287	0.3417	59.09	0.01243	0.00533

MacAdam Ellipse (P3, P5)					
Step	CIE x	CIE y	$\theta$	a	b
3-step	0.3123	0.3282	58.57	0.00669	0.00285
5-step	0.3123	0.3282	58.57	0.01115	0.00475

**Note:** Samsung maintains measurement tolerance of:  $C_x, C_y = \pm 0.005$

### 3. Typical Characteristics Graphs

#### a) Spectrum Distribution ( $I_f = 65 \text{ mA}$ , $T_s = 25 \text{ }^\circ\text{C}$ )

CCT: 2700 K (90 CRI)

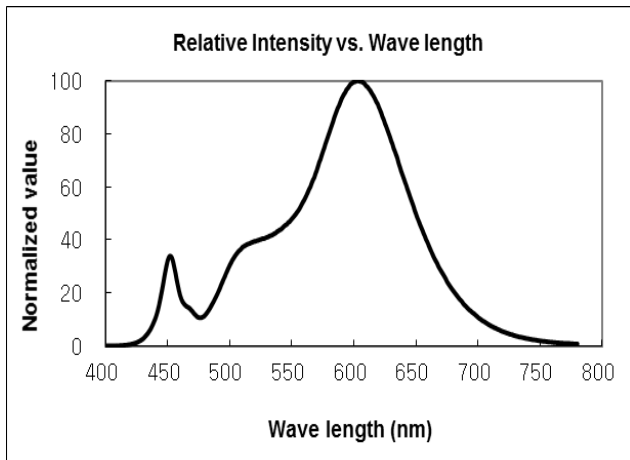

CCT: 3000 K (90 CRI)

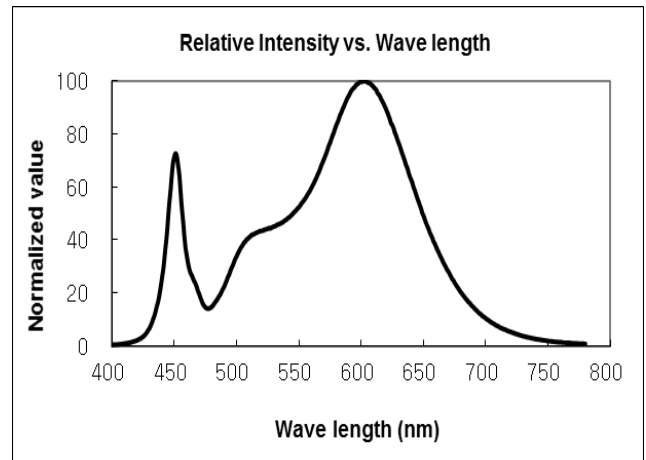

CCT: 3500 K (90 CRI)

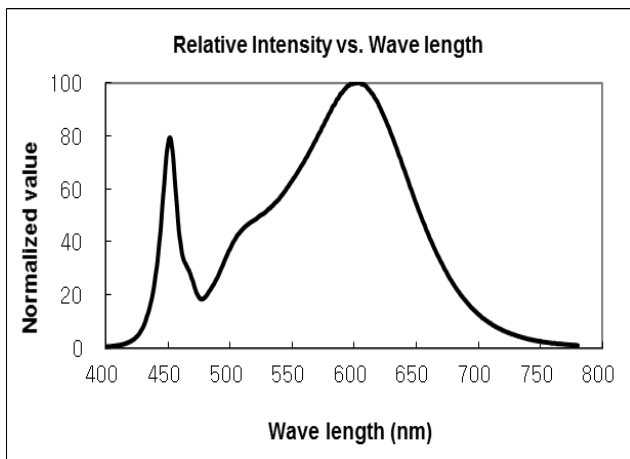

CCT: 4000 K (90 CRI)

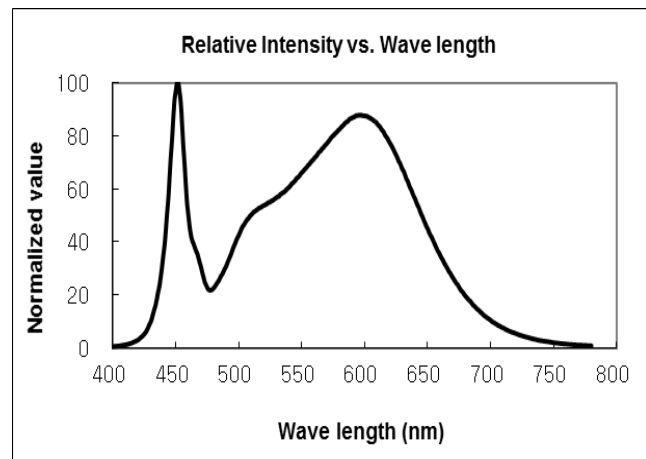

CCT: 5000 K (90 CRI)

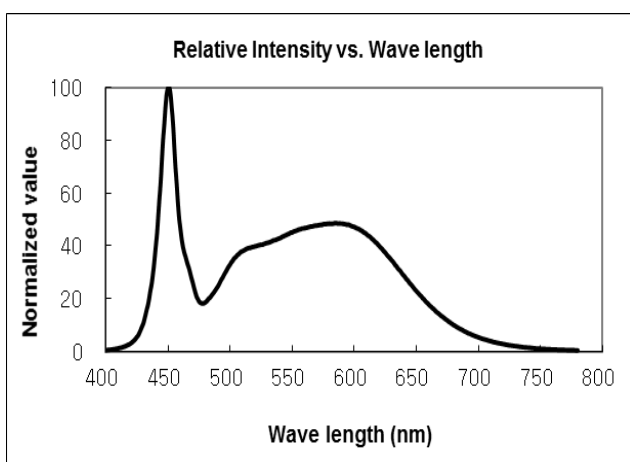

CCT: 5700 K (90 CRI)

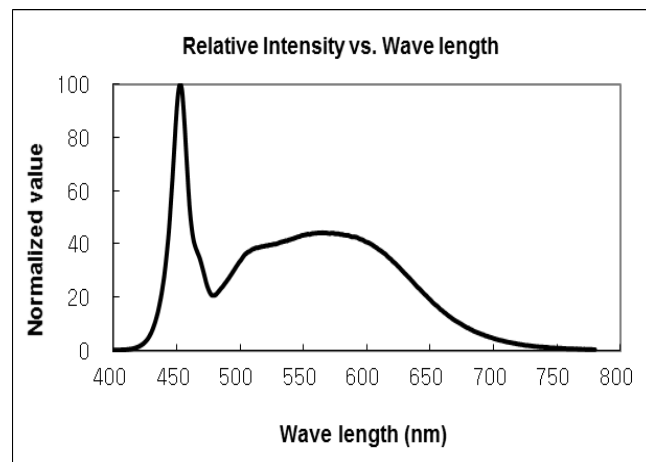

CCT: 6500 K (90 CRI)

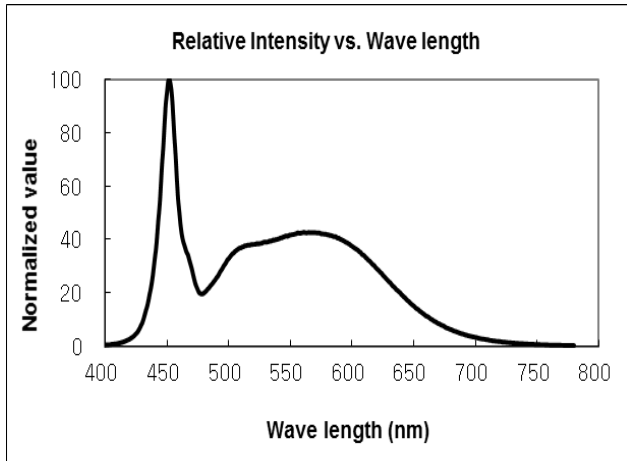

### b) Forward Current Characteristics ( $T_s = 25^\circ\text{C}$ )

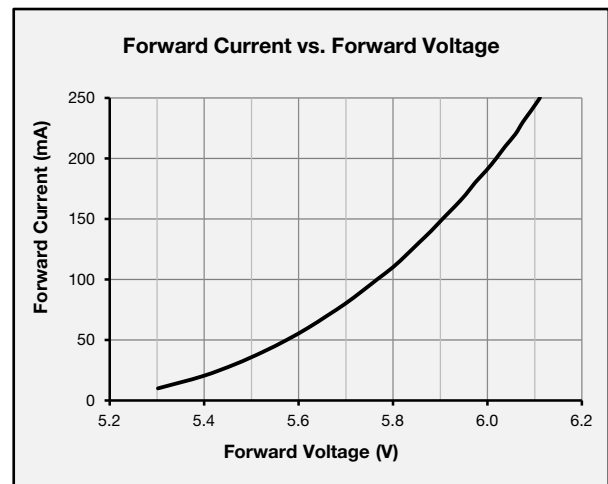
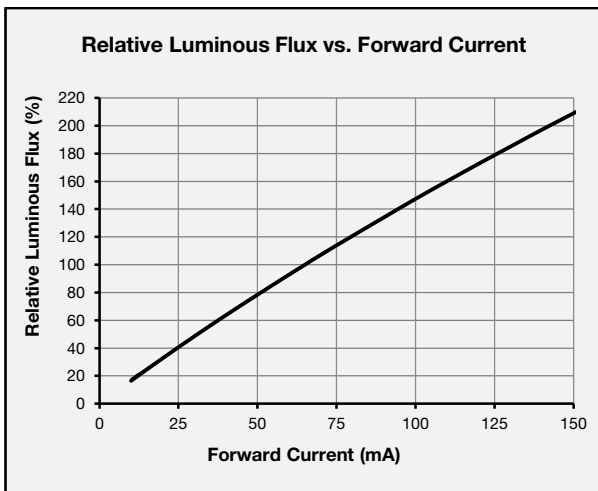

### c) Temperature Characteristics ( $I_f = 65\text{ mA}$ )

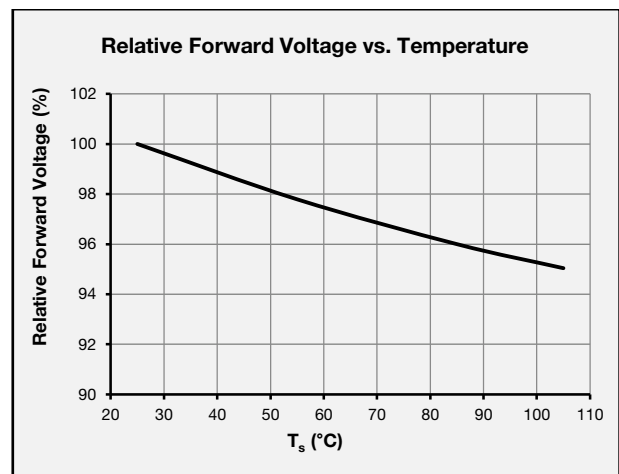
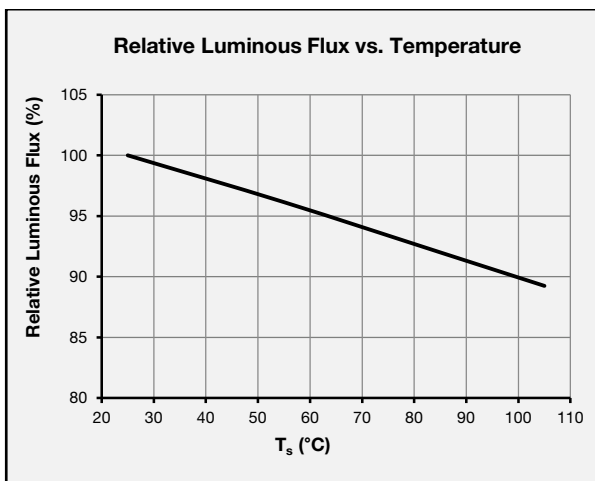

d) Color Shift Characteristics ( $I_F = 65 \text{ mA}$ ,  $T_s = 25 \text{ }^\circ\text{C}$ )

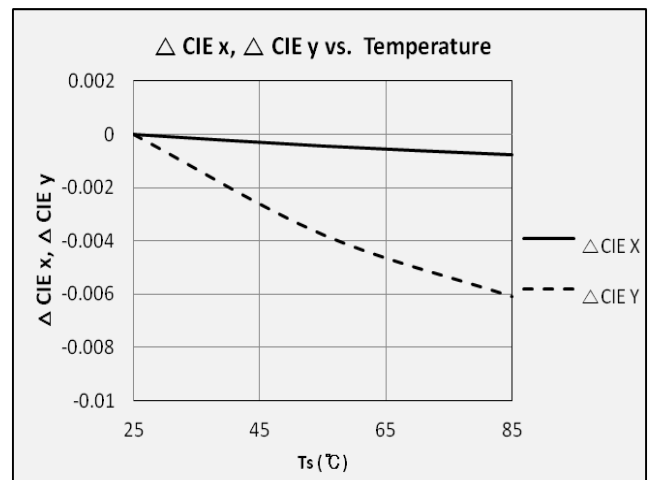
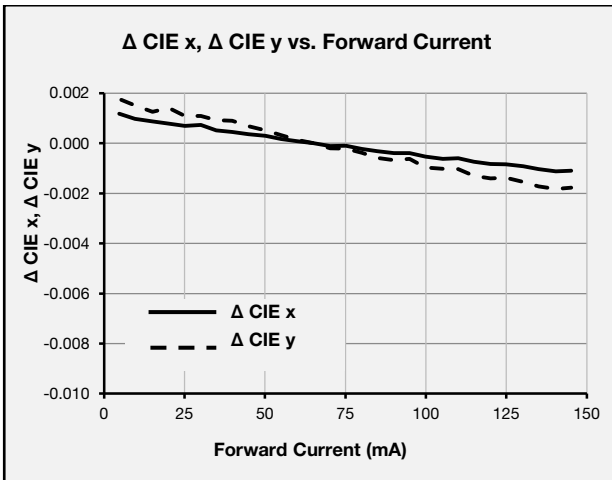

e) Derating Curve

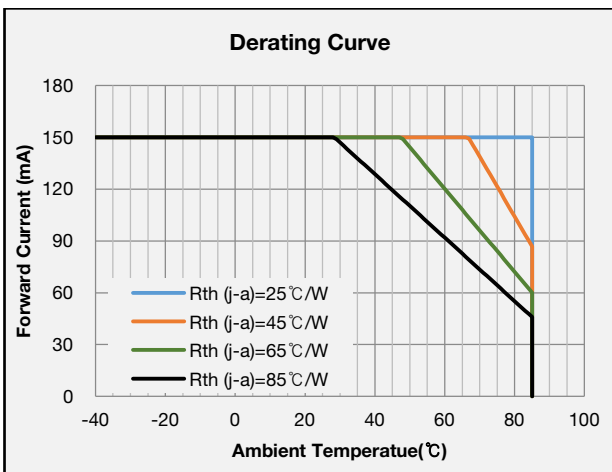

f) Beam Angle Characteristics ( $I_F = 65 \text{ mA}$ ,  $T_s = 25 \text{ }^\circ\text{C}$ )

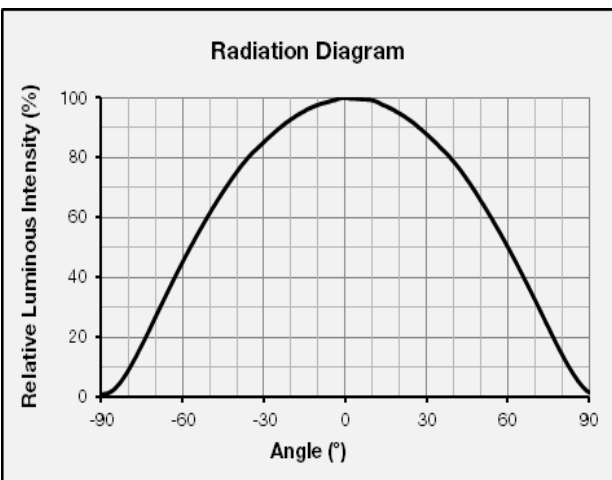

#### 4. Outline Drawing & Dimension

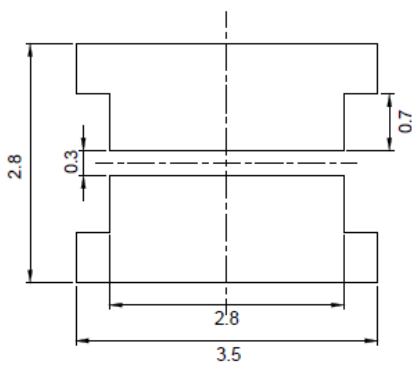
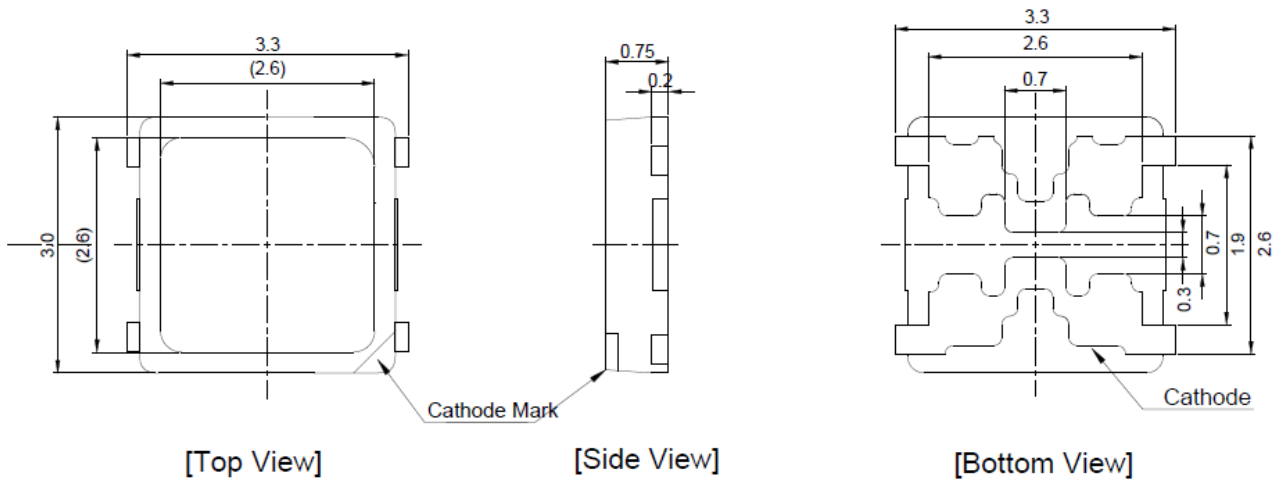

[RECOMMENDED PCB SOLDER PAD]

Measurement unit : mm  
Tolerance :  $\pm 0.1$  mm

#### Notes:

- 1) This LED has built-in ESD protection device(s) connected in parallel to LED chip(s).
- 2)  $T_s$  point and measurement method:
  - ① Measure one point at the cathode pad, if necessary remove PSR of PCB to reach  $T_s$  point.
  - ② All pads must be soldered to the PCB to dissipate heat properly, otherwise the LED can be damaged.

#### Precautions:

- 1) Pressure on the LEDs will influence to the reliability of the LEDs. Precautions should be taken to avoid strong pressure on the LEDs. Do not put stress on the LEDs during heating.
- 2) Re-soldering should not be done after the LEDs have been soldered. If re-soldering is unavoidable, LED's characteristics should be carefully checked before and after such repair.
- 3) Do not stack assembled PCBs together. Since materials of LEDs is soft, abrasion between two PCB assembled with LED might cause catastrophic failure of the LEDs.

## 5. Reliability Test Items & Conditions

### a) Test Items

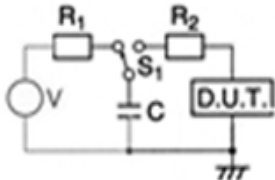
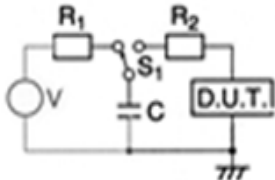
Test Item	Test Condition	Test Hour / Cycle	Sample No.
Room Temperature Life Test	25 °C, DC 150 mA	1000 h	22
High Temperature Life Test	85 °C, DC 150 mA	1000 h	22
High Temperature Humidity Life Test	85 °C, 85 % RH, DC 150 mA	1000 h	22
Low Temperature Life Test	-40 °C, DC 150 mA	1000 h	22
Powered Temperature Cycle Test	-45 °C ~ 85 °C, each 20 min, on/off 5 min Temp. Change time 100min, DC 150 mA	100 cycles	22
Temperature Cycling	-45 °C / 15 min ↔ 125 °C / 15 min → Hot plate 180 °C	500 cycles	100
High Temperature Storage	120 °C	1000 h	11
Low Temperature Storage	-40 °C	1000 h	11
ESD (HBM)		R <sub>1</sub> : 10 MΩ R <sub>2</sub> : 1.5 kΩ C: 100 pF V: ±5 kV	5 times 30
ESD (MM)		R <sub>1</sub> : 10 MΩ R <sub>2</sub> : 0 C: 200 pF V: ±0.5 kV	5 times 30
Vibration Test	20~2000~20 Hz, 200 m/s <sup>2</sup> , sweep 4 min X, Y, Z 3 direction, each 1 cycle	4 cycles	11
Mechanical Shock Test	1500 g, 0.5 ms 3 shocks each X-Y-Z axis	5 cycles	11

### b) Criteria for Judging the Damage

Item	Symbol	Test Condition (T <sub>s</sub> = 25 °C)	Limit	
			Min	Max
Forward Voltage	V <sub>F</sub>	I <sub>F</sub> = 150 mA	Init. Value * 0.9	Init. Value * 1.1
Luminous Flux	Φ <sub>v</sub>	I <sub>F</sub> = 150 mA	Init. Value * 0.7	Init. Value * 1.1



## 6. Soldering Conditions

### a) Reflow Conditions (Pb free)

Reflow frequency: 2 times max.

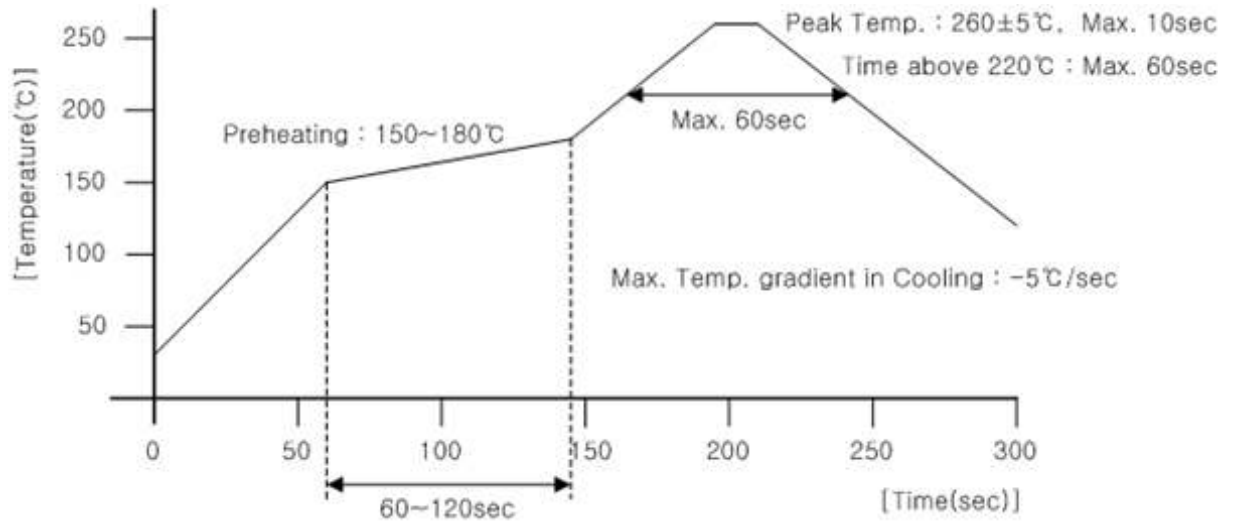

### b) Manual Soldering Conditions

Not more than 5 seconds @ max. 300 °C, under soldering iron.

## 7. Tape & Reel

### a) Taping Dimension

(unit: mm)

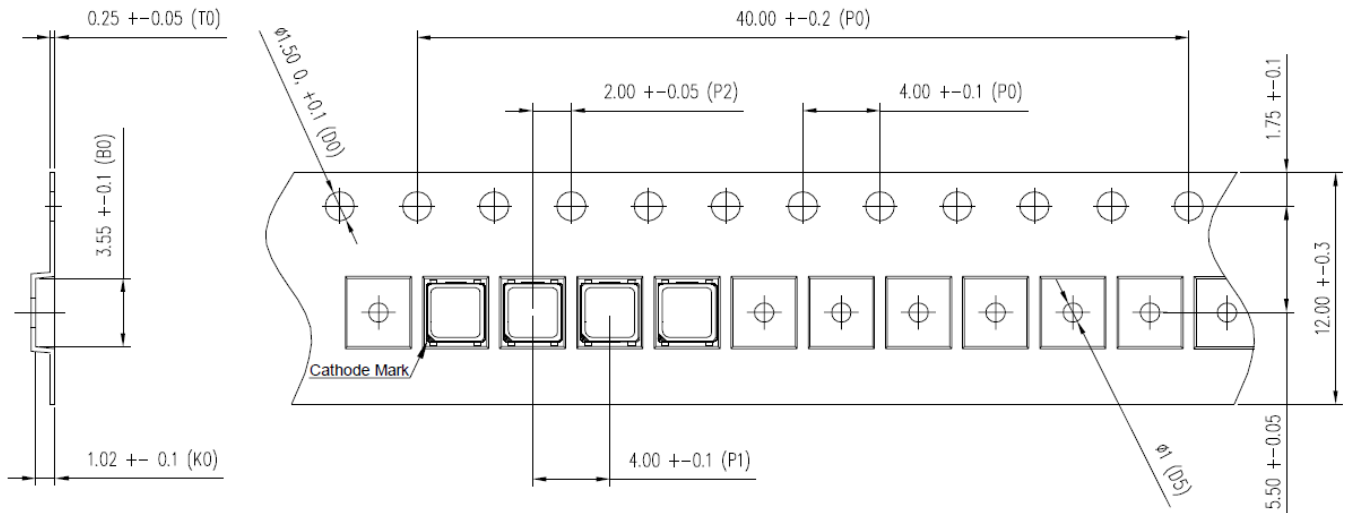

Taping Direction

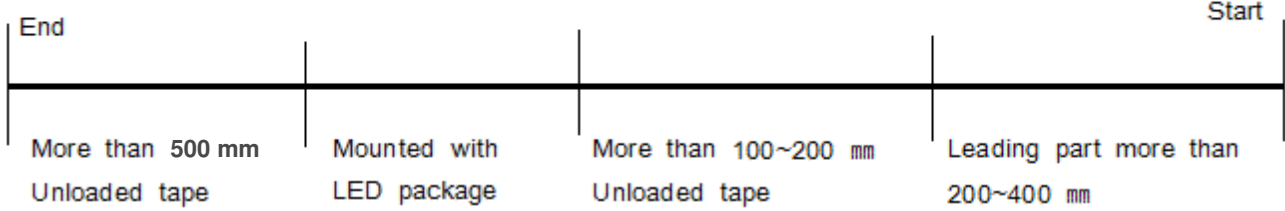
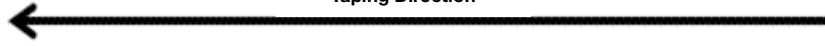

## b) Reel Dimension

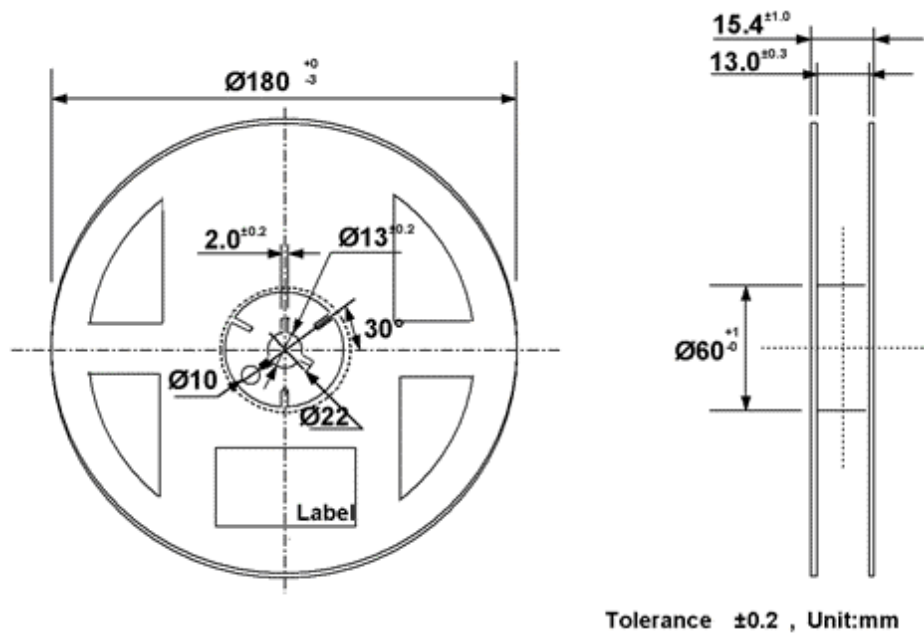
**Notes:**

- 1) Quantity: The quantity/reel is 4,000 pcs
- 2) Cumulative tolerance: Cumulative tolerance / 10 pitches is  $\pm 0.2$  mm
- 3) Adhesion strength of cover tape: Adhesion strength is 0.1-0.7 N when the cover tape is turned off from the carrier tape at  $10^\circ$  angle to the carrier tape
- 4) Packaging: P/N, Manufacturing data code no. and quantity are indicated on the aluminum packing bag

## 8. Label Structure

### a) Label Structure

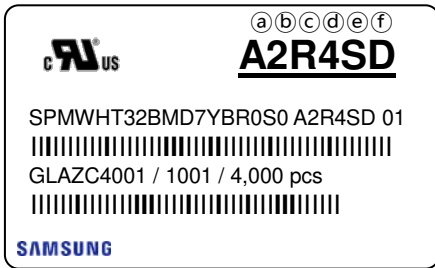

Note: Denoted bin code and product code above is only an example

Bin Code:

- ⒶⒷ: Forward Voltage bin (refer to page 9)
- ⒸⒹ: Chromaticity bin (refer to page 10~13)
- ⒺⒻ: Luminous Flux bin (refer to page 6)

### b) Lot Number

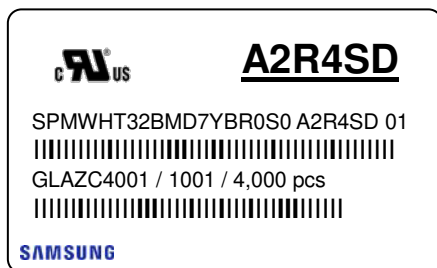

The lot number is composed of the following characters:

①②③④⑤⑥⑦⑧⑨ / 1ⒶⒷⒸ / 4,000 pcs

- ① : Production site (S: Giheung, Korea, G: Tianjin, China)
- ② : L (LED)
- ③ : Product state (A: Normal, B: Bulk, C: First Production, R: Reproduction, S: Sample)
- ④ : Year (Z: 2015, A: 2016, B:2017 ...)
- ⑤ : Month (1~9, A, B, C)
- ⑥ : Day (1~9, A, B~V)
- ⑦⑧⑨ : Product serial number (001 ~ 999)
- ⒶⒷⒸ : Reel number (001 ~ 999)

## 9. Packing Structure

### a) Packing Process

Reel

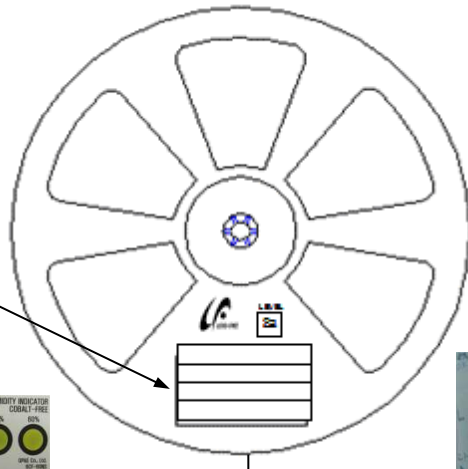

Aluminum Vinyl Packing Bag

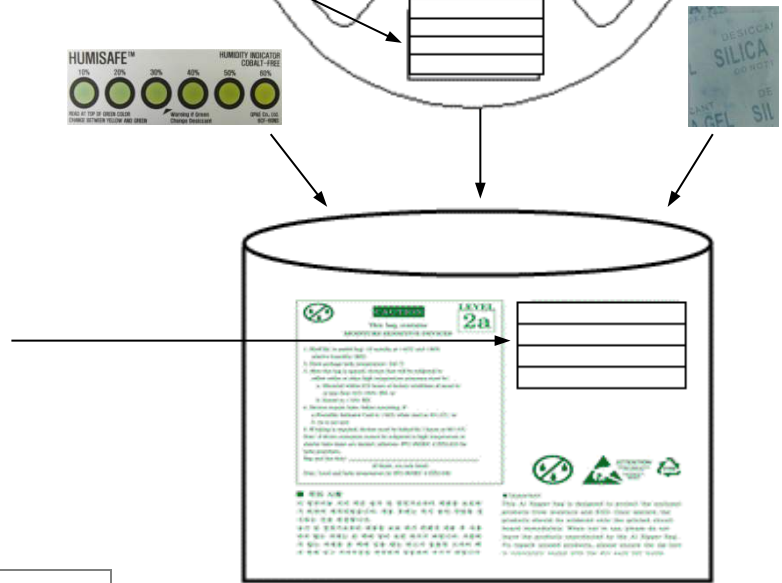
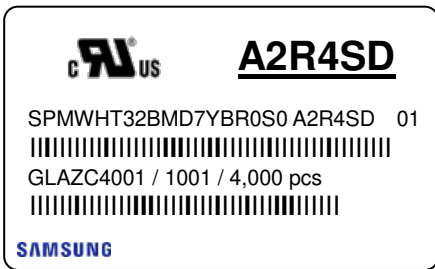

Outer Box

Material: Paper (SW3B(B))

Type	Size (mm)			Note
	L	W	H	
7 inch L	245 ± 5	220 ± 5	182 ± 5	Up to 10 reels
7 inch S	245 ± 5	220 ± 5	86 ± 5	Up to 5 reels

① Side Label

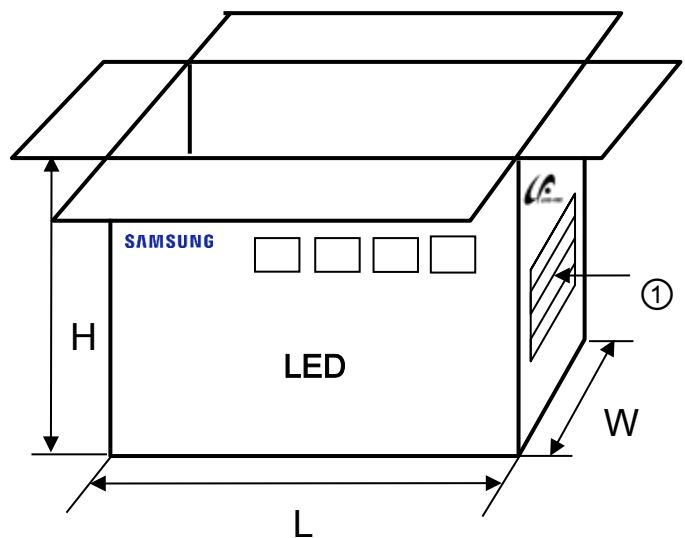
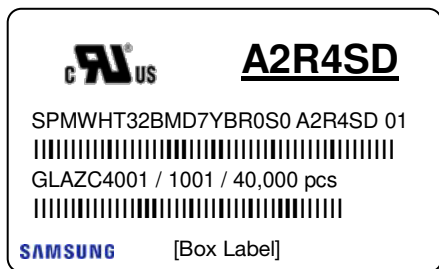

b) Packing Process for kitting (The quantity of PKG on the Reel to be Max 4,000pcs)

Reel

**Kitting 'A'**

**Kitting 'B'**

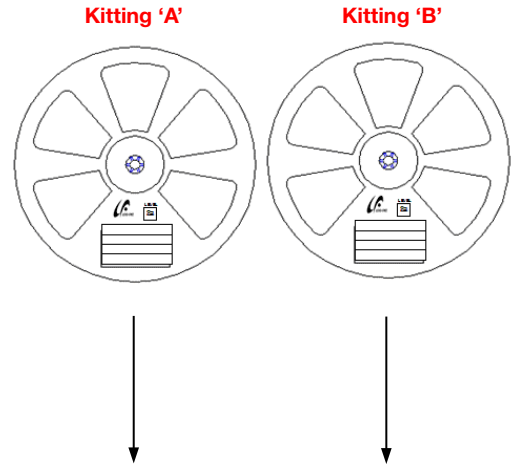

Aluminum Vinyl Packing Bag

**Kitting 'A'**

**Kitting 'B'**

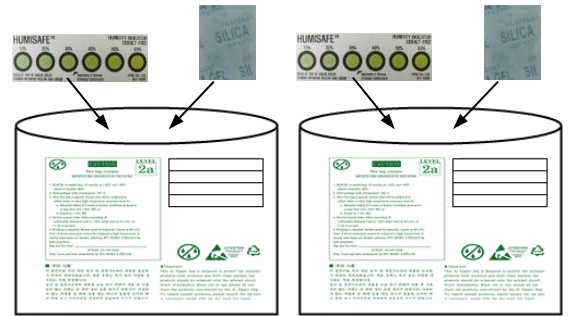

Outer Box

**Kitting 'A'**

**Kitting 'B'**

Note: "★" can be Nominal CCT code.

Material: Paper (SW3B(B))

Type	Size (mm)			Note
	L	W	H	
7 inch L	245 ± 5	220 ± 5	182 ± 5	Up to 10 reels

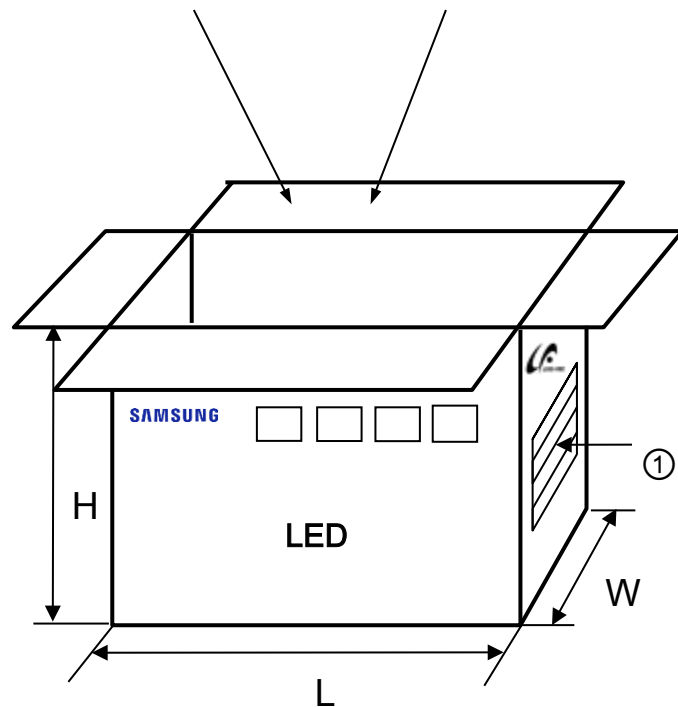



## 10. Precautions in Handling & Use

- 1) For over-current protection, users are recommended to apply resistors connected in series with the LEDs to mitigate sudden change of the forward current caused by shift of forward voltage.
- 2) This device should not be used in any type of fluid such as water, oil, organic solvent, etc. When cleaning is required, IPA is recommended as the cleaning agent. Some solvent-based cleaning agent may damage the silicone resins used in the device.
- 3) When the device is in operation, the forward current should be carefully determined considering the maximum ambient temperature and corresponding junction temperature.
- 4) LEDs must be stored in a clean environment. If the LEDs are to be stored for three months or more after being shipped from Samsung, they should be packed with a nitrogen-filled container (shelf life of sealed bags is 12 months at temperature 0~40 °C, 0~90 % RH).
- 5) After storage bag is opened, device subjected to soldering, solder reflow, or other high temperature processes must be:
  - a. Mounted within 672 hours (28 days) at an assembly line with a condition of no more than 30 °C / 60 % RH<sup>\*Note 1</sup>, or
  - b. Mounted within 24 hours (1 day) at an assembly line with a condition of more than 30 °C / 70 % RH<sup>\*Note 2</sup>, or
  - c. Stored at <10 % RH.

\*Note 1, 2: IPC/JEDEC J-STD-033A, Recommended Equivalent Total Floor Life Table

Package Type and Body Thickness	Moisture Sensitivity Level	Maximum Percent Relative Humidity						Temperature
		40%	50%	60%	70%	80%	90%	
Body Thickness <2.1mm	Level 2a	∞	∞	28	1	1	1	30°C
		∞	∞	∞	2	1	1	25°C
		∞	∞	∞	2	2	1	20°C

- 6) Repack unused devices with anti-moisture packing, fold to close any opening and then store in a dry place.
- 7) Devices require baking before mounting, if humidity card reading is >60 % at 23 ± 5 °C.
- 8) It is recommended to be baked for 12 hour at 60 ± 5 °C, if baking is required.
- 9) The LEDs are sensitive to the static electricity and surge current. It is recommended to use a wrist band or anti-electrostatic glove when handling the LEDs. If voltage exceeding the absolute maximum rating is applied to LEDs, it may cause damage or even destruction to LED devices. Damaged LEDs may show some unusual characteristics such as increase in leakage current, lowered turn-on voltage, or abnormal lighting of LEDs at low current.
- 10) VOCs (Volatile Organic Compounds) can be generated from adhesives, flux, hardener or organic additives used in luminaires (fixtures). Transparent LED silicone encapsulant is permeable to those chemicals and they may lead to a discoloration of encapsulant when they exposed to heat or light. This phenomenon can cause a significant loss of light emitted (output) from the luminaires. In order to prevent these problems, we recommend users to know the physical properties of materials used in luminaires and they must be carefully selected.
- 11) Risk of sulfurization (or tarnishing)

The LED from Samsung uses a silver-plated lead frame and its surface color may change to black (or dark colored) when it is exposed to sulfur (S), chlorine (Cl) or other halogen compound. Sulfurization of lead frame may cause intensity degradation, change of chromaticity coordinates and, in extreme cases, open circuit. It requires caution. Due to possible sulfurization of lead frame, LED should not be used and stored together with oxidizing substances made of materials such as rubber, plain paper, lead solder cream, etc.



# Legal and additional information.

## [About Samsung Electronics Co., Ltd.](#)

Samsung inspires the world and shapes the future with transformative ideas and technologies. The company is redefining the worlds of TVs, smartphones, wearable devices, tablets, digital appliances, network systems, and memory, system LSI, foundry and LED solutions. For the latest news, please visit the Samsung Newsroom at [news.samsung.com](http://news.samsung.com).

Copyright © 2018 Samsung Electronics Co., Ltd. All rights reserved.

Samsung is a registered trademark of Samsung Electronics Co., Ltd.

Specifications and designs are subject to change without notice. Non-metric weights and measurements are approximate. All data were deemed correct at time of creation. Samsung is not liable for errors or omissions. All brand, product, service names and logos are trademarks and/or registered trademarks of their respective owners and are hereby recognized and acknowledged.

Samsung Electronics Co., Ltd.

95, Samsung 2-ro

Giheung-gu

Yongin-si, Gyeonggi-do, 446-711

KOREA

[www.samsungled.com](http://www.samsungled.com)

**SAMSUNG**