

# ON Semiconductor

## Is Now

# onsemi™

To learn more about onsemi™, please visit our website at  
[www.onsemi.com](http://www.onsemi.com)

---

**onsemi** and **onsemi** and other names, marks, and brands are registered and/or common law trademarks of Semiconductor Components Industries, LLC dba "**onsemi**" or its affiliates and/or subsidiaries in the United States and/or other countries. **onsemi** owns the rights to a number of patents, trademarks, copyrights, trade secrets, and other intellectual property. A listing of **onsemi** product/patent coverage may be accessed at [www.onsemi.com/site/pdf/Patent-Marking.pdf](http://www.onsemi.com/site/pdf/Patent-Marking.pdf). **onsemi** reserves the right to make changes at any time to any products or information herein, without notice. The information herein is provided "as-is" and **onsemi** makes no warranty, representation or guarantee regarding the accuracy of the information, product features, availability, functionality, or suitability of its products for any particular purpose, nor does **onsemi** assume any liability arising out of the application or use of any product or circuit, and specifically disclaims any and all liability, including without limitation special, consequential or incidental damages. Buyer is responsible for its products and applications using **onsemi** products, including compliance with all laws, regulations and safety requirements or standards, regardless of any support or applications information provided by **onsemi**. "Typical" parameters which may be provided in **onsemi** data sheets and/or specifications can and do vary in different applications and actual performance may vary over time. All operating parameters, including "Typicals" must be validated for each customer application by customer's technical experts. **onsemi** does not convey any license under any of its intellectual property rights nor the rights of others. **onsemi** products are not designed, intended, or authorized for use as a critical component in life support systems or any FDA Class 3 medical devices or medical devices with a same or similar classification in a foreign jurisdiction or any devices intended for implantation in the human body. Should Buyer purchase or use **onsemi** products for any such unintended or unauthorized application, Buyer shall indemnify and hold **onsemi** and its officers, employees, subsidiaries, affiliates, and distributors harmless against all claims, costs, damages, and expenses, and reasonable attorney fees arising out of, directly or indirectly, any claim of personal injury or death associated with such unintended or unauthorized use, even if such claim alleges that **onsemi** was negligent regarding the design or manufacture of the part. **onsemi** is an Equal Opportunity/Affirmative Action Employer. This literature is subject to all applicable copyright laws and is not for resale in any manner. Other names and brands may be claimed as the property of others.

# Field Stop Trench IGBT

## 650 V, 75 A, TO247

### AFGHL75T65SQ

Using the novel field stop 4th generation IGBT technology, AFGHL75T65SQ offers the optimum performance with both low conduction and switching losses for high efficiency operations in various applications, which does not require reverse recovery specification.

#### Features

- Maximum Junction Temperature:  $T_J = 175^\circ\text{C}$
- Positive Temperature Co-efficient for Easy Parallel Operating
- High Current Capability
- Low Saturation Voltage:  $V_{CE(Sat)} = 1.6\text{ V (Typ.) @ } I_C = 75\text{ A}$
- 100% of the Parts are Tested for  $I_{LM}$  (Note 2)
- Fast Switching
- Tight Parameter Distribution
- AEC-Q101 Qualified and PPAP Capable

#### Typical Applications

- Automotive
- On & Off Board Chargers
- DC-DC Converters
- PFC
- Industrial Inverter

#### MAXIMUM RATINGS

| Rating   | Symbol               | Value   | Unit             |
|--|----------------------|---|------------------|
| Collector-to-Emitter Voltage   | $V_{CES}$            | 650   | V                |
| Gate-to-Emitter Voltage<br>Transient Gate-to-Emitter Voltage             | $V_{GES}$            | $\pm 20$<br>$\pm 30$                                      | V                |
| Collector Current (Note 1)   | $I_C$                | 80<br>75  | A                |
|  |                      | @ $T_C = 25^\circ\text{C}$<br>@ $T_C = 100^\circ\text{C}$ |                  |
| Pulsed Collector Current (Note 2)  | $I_{LM}$             | 300   | A                |
| Pulsed Collector Current (Note 3)  | $I_{CM}$             | 300   | A                |
| Maximum Power Dissipation  | $P_D$                | 375<br>188  | W                |
|  |                      | @ $T_C = 25^\circ\text{C}$<br>@ $T_C = 100^\circ\text{C}$ |                  |
| Operating Junction / Storage Temperature Range                           | $T_J$ ,<br>$T_{STG}$ | -55 to<br>+175  | $^\circ\text{C}$ |
| Maximum Lead Temp. for Soldering Purposes, 1/8" from case for 10 seconds | $T_L$                | 265   | $^\circ\text{C}$ |

Stresses exceeding those listed in the Maximum Ratings table may damage the device. If any of these limits are exceeded, device functionality should not be assumed, damage may occur and reliability may be affected.

1. Value limited by bond wire
2.  $V_{CC} = 400\text{ V}$ ,  $V_{GE} = 15\text{ V}$ ,  $I_C = 300\text{ A}$ ,  $R_G = 15\ \Omega$ , Inductive Load, 100% of the Parts are Tested.
3. Repetitive Rating: pulse width limited by max. Junction temperature



ON Semiconductor®

[www.onsemi.com](http://www.onsemi.com)

75 A, 650 V  
 $V_{CESat} = 1.6\text{ V (Typ.)}$

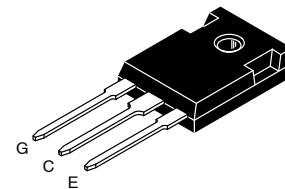
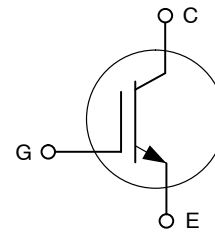

TO-247-3LD  
CASE 340CX

#### MARKING DIAGRAM



- A = Assembly Location
- YWW = 3-Digit Date Code
- ZZ = 2-Digit Lot Traceability Code
- AFGHL75T65SQ = Specific Device Code

#### ORDERING INFORMATION

| Device       | Package   | Shipping        |
|--------------|-----------|-----------------|
| AFGHL75T65SQ | TO-247-3L | 30 Units / Rail |

# AFGHL75T65SQ

## THERMAL CHARACTERISTICS

| Rating  | Symbol          | Max | Unit                        |
|---|-----------------|-----|-----------------------------|
| Thermal resistance junction-to-case, for IGBT | $R_{\theta JC}$ | 0.4 | $^{\circ}\text{C}/\text{W}$ |
| Thermal resistance junction-to-ambient        | $R_{\theta JA}$ | 40  | $^{\circ}\text{C}/\text{W}$ |

## ELECTRICAL CHARACTERISTICS ( $T_J = 25^{\circ}\text{C}$ unless otherwise noted)

| Parameter | Test Conditions | Symbol | Min | Typ | Max | Unit |
|-----------|-----------------|--------|-----|-----|-----|------|
|-----------|-----------------|--------|-----|-----|-----|------|

### OFF CHARACTERISTICS

|   |  |                                      |     |     |           |                             |
|---|--|--------------------------------------|-----|-----|-----------|-----------------------------|
| Collector-emitter breakdown voltage, gate-emitter short-circuited | $V_{GE} = 0\text{ V}$ ,<br>$I_C = 1\text{ mA}$     | $BV_{CES}$                           | 650 | -   | -         | V                           |
| Temperature Coefficient of Breakdown Voltage                      | $V_{GE} = 0\text{ V}$ ,<br>$I_C = 1\text{ mA}$     | $\frac{\Delta BV_{CES}}{\Delta T_J}$ | -   | 0.6 | -         | $\text{V}/^{\circ}\text{C}$ |
| Collector-emitter cut-off current, gate-emitter short-circuited   | $V_{GE} = 0\text{ V}$ ,<br>$V_{CE} = 650\text{ V}$ | $I_{CES}$                            | -   | -   | 250       | $\mu\text{A}$               |
| Gate leakage current, collector-emitter short-circuited           | $V_{GE} = 20\text{ V}$ ,<br>$V_{CE} = 0\text{ V}$  | $I_{GES}$                            | -   | -   | $\pm 400$ | nA                          |

### ON CHARACTERISTICS

|                                      |  |               |     |     |     |   |
|--------------------------------------|--|---------------|-----|-----|-----|---|
| Gate-emitter threshold voltage       | $V_{GE} = V_{CE}$ , $I_C = 75\text{ mA}$   | $V_{GE(th)}$  | 3.4 | 4.9 | 6.4 | V |
| Collector-emitter saturation voltage | $V_{GE} = 15\text{ V}$ , $I_C = 75\text{ A}$<br>$V_{GE} = 15\text{ V}$ , $I_C = 75\text{ A}$ , $T_J = 175^{\circ}\text{C}$ | $V_{CE(sat)}$ | -   | 1.6 | 2.1 | V |
|                                      |  |               | -   | 2.0 | -   |   |

### DYNAMIC CHARACTERISTICS

|                              |  |           |   |       |   |    |
|------------------------------|--|-----------|---|-------|---|----|
| Input capacitance            | $V_{CE} = 30\text{ V}$ ,<br>$V_{GE} = 0\text{ V}$ ,<br>$f = 1\text{ MHz}$    | $C_{ies}$ | - | 4574  | - | pF |
| Output capacitance           |  | $C_{oes}$ | - | 289.4 | - |    |
| Reverse transfer capacitance |  | $C_{res}$ | - | 11.2  | - |    |
| Gate charge total            | $V_{CE} = 400\text{ V}$ ,<br>$I_C = 75\text{ A}$ ,<br>$V_{GE} = 15\text{ V}$ | $Q_g$     | - | 139   | - | nC |
| Gate-to-emitter charge       |  | $Q_{ge}$  | - | 25    | - |    |
| Gate-to-collector charge     |  | $Q_{gc}$  | - | 33    | - |    |

### SWITCHING CHARACTERISTICS, INDUCTIVE LOAD

|                         |   |              |   |      |   |    |
|-------------------------|---|--------------|---|------|---|----|
| Turn-on delay time      | $T_C = 25^{\circ}\text{C}$ ,<br>$V_{CC} = 400\text{ V}$ ,<br>$I_C = 37.5\text{ A}$ ,<br>$R_G = 4.7\ \Omega$ ,<br>$V_{GE} = 15\text{ V}$ ,<br>Inductive Load<br>Energy losses include "tail" and diode reverse recovery. Diode from AFGHL75T65SQD. | $t_{d(on)}$  | - | 23   | - | ns |
| Rise time               |   | $t_r$        | - | 17   | - |    |
| Turn-off delay time     |   | $t_{d(off)}$ | - | 112  | - |    |
| Fall time               |   | $t_f$        | - | 8    | - |    |
| Turn-on switching loss  |   | $E_{on}$     | - | 0.61 | - | mJ |
| Turn-off switching loss |   | $E_{off}$    | - | 0.21 | - |    |
| Total switching loss    |   | $E_{ts}$     | - | 0.82 | - |    |
| Turn-on delay time      | $T_C = 25^{\circ}\text{C}$ ,<br>$V_{CC} = 400\text{ V}$ ,<br>$I_C = 75\text{ A}$ ,<br>$R_G = 4.7\ \Omega$ ,<br>$V_{GE} = 15\text{ V}$ ,<br>Inductive Load<br>Energy losses include "tail" and diode reverse recovery. Diode from AFGHL75T65SQD.   | $t_{d(on)}$  | - | 25   | - | ns |
| Rise time               |   | $t_r$        | - | 46   | - |    |
| Turn-off delay time     |   | $t_{d(off)}$ | - | 106  | - |    |
| Fall time               |   | $t_f$        | - | 67   | - |    |
| Turn-on switching loss  |   | $E_{on}$     | - | 1.86 | - | mJ |
| Turn-off switching loss |   | $E_{off}$    | - | 1.13 | - |    |
| Total switching loss    |   | $E_{ts}$     | - | 2.99 | - |    |

# AFGHL75T65SQ

## ELECTRICAL CHARACTERISTICS ( $T_J = 25^\circ\text{C}$ unless otherwise noted)

| Parameter | Test Conditions | Symbol | Min | Typ | Max | Unit |
|-----------|-----------------|--------|-----|-----|-----|------|
|-----------|-----------------|--------|-----|-----|-----|------|

### SWITCHING CHARACTERISTICS, INDUCTIVE LOAD

|                         |  |              |   |      |   |    |
|-------------------------|--|--------------|---|------|---|----|
| Turn-on delay time      | $T_C = 175^\circ\text{C}$ ,<br>$V_{CC} = 400\text{ V}$ ,<br>$I_C = 37.5\text{ A}$ ,<br>$R_G = 4.7\ \Omega$ ,<br>$V_{GE} = 15\text{ V}$ ,<br>Inductive Load<br>Energy losses include "tail" and diode reverse recovery. Diode from AFGHL75T65SQD. | $t_{d(on)}$  | - | 21   | - | ns |
| Rise time               |  | $t_r$        | - | 19   | - |    |
| Turn-off delay time     |  | $t_{d(off)}$ | - | 126  | - |    |
| Fall time               |  | $t_f$        | - | 7    | - |    |
| Turn-on switching loss  |  | $E_{on}$     | - | 1.20 | - | mJ |
| Turn-off switching loss |  | $E_{off}$    | - | 0.41 | - |    |
| Total switching loss    |  | $E_{ts}$     | - | 1.61 | - |    |
| Turn-on delay time      | $T_C = 175^\circ\text{C}$ ,<br>$V_{CC} = 400\text{ V}$ ,<br>$I_C = 75\text{ A}$ ,<br>$R_G = 4.7\ \Omega$ ,<br>$V_{GE} = 15\text{ V}$ ,<br>Inductive Load<br>Energy losses include "tail" and diode reverse recovery. Diode from AFGHL75T65SQD.   | $t_{d(on)}$  | - | 24   | - | ns |
| Rise time               |  | $t_r$        | - | 46   | - |    |
| Turn-off delay time     |  | $t_{d(off)}$ | - | 115  | - |    |
| Fall time               |  | $t_f$        | - | 72   | - |    |
| Turn-on switching loss  |  | $E_{on}$     | - | 2.84 | - | mJ |
| Turn-off switching loss |  | $E_{off}$    | - | 1.35 | - |    |
| Total switching loss    |  | $E_{ts}$     | - | 4.20 | - |    |

Product parametric performance is indicated in the Electrical Characteristics for the listed test conditions, unless otherwise noted. Product performance may not be indicated by the Electrical Characteristics if operated under different conditions.

# AFGHL75T65SQ

## TYPICAL CHARACTERISTICS

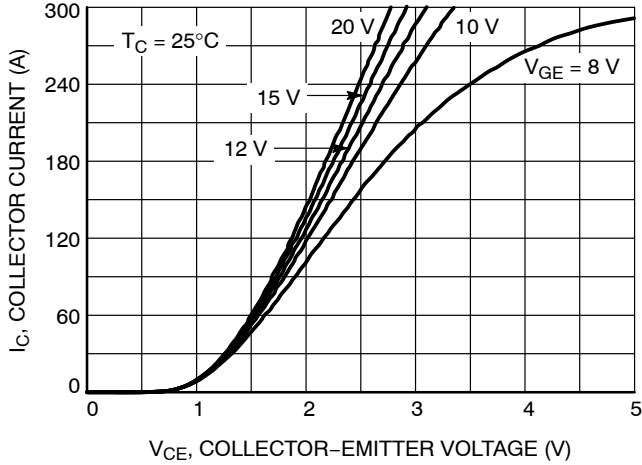

**Figure 1. Typical Output Characteristics**  
( $T_c = 25^\circ\text{C}$ )

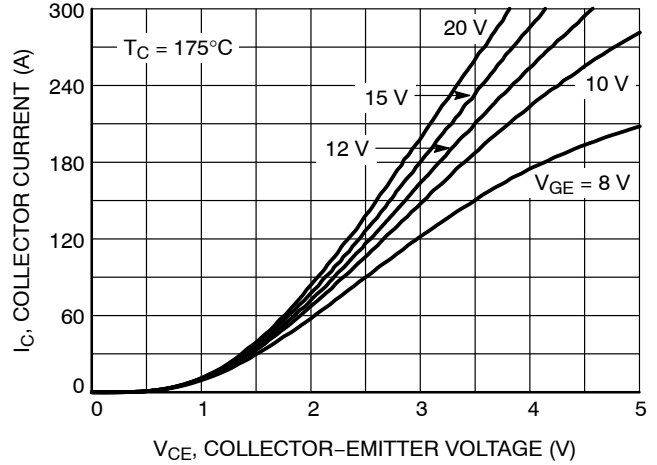

**Figure 2. Typical Output Characteristics**  
( $T_c = 175^\circ\text{C}$ )

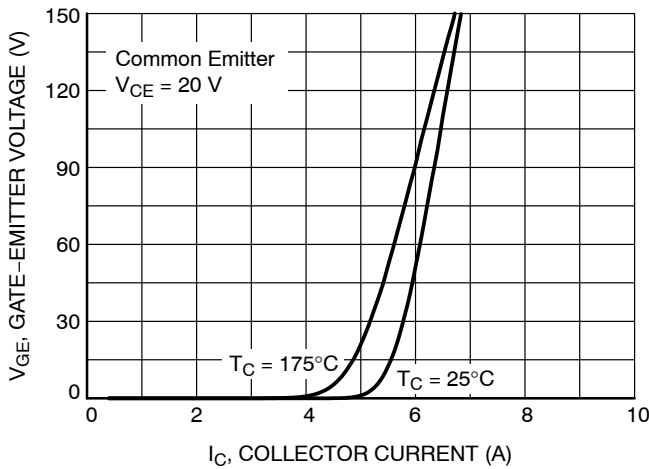

**Figure 3. Transfer Characteristics**

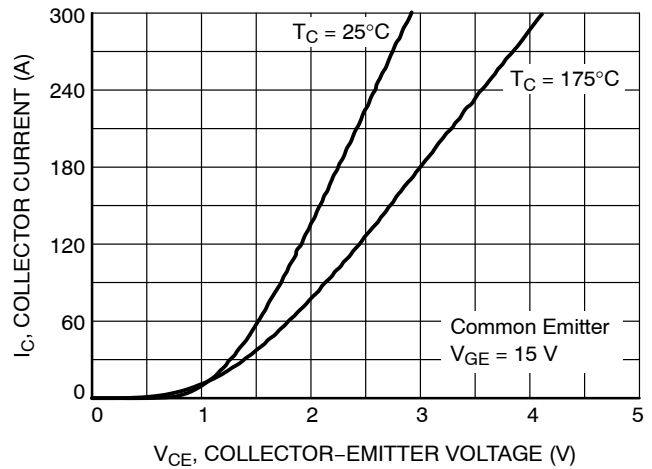

**Figure 4. Typical Saturation Voltage Characteristics**

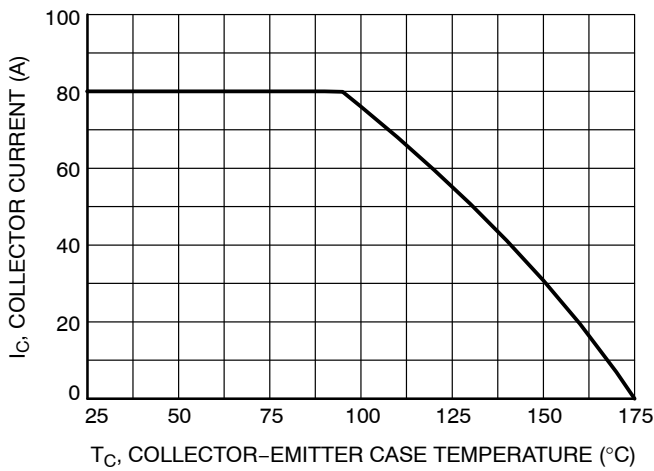

**Figure 5. Collector Current Derating**

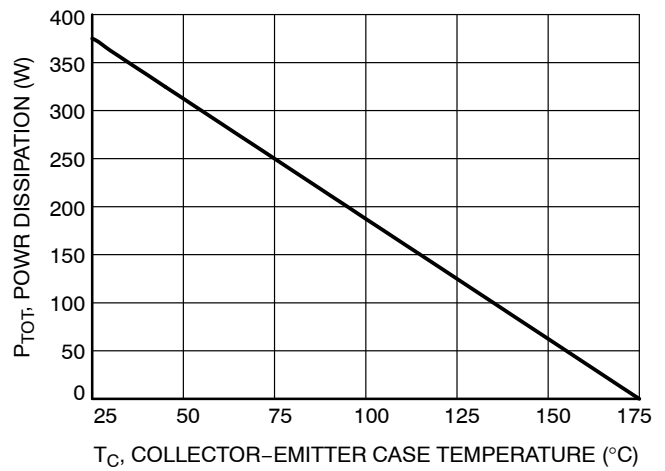

**Figure 6. Power Dissipation**

TYPICAL CHARACTERISTICS

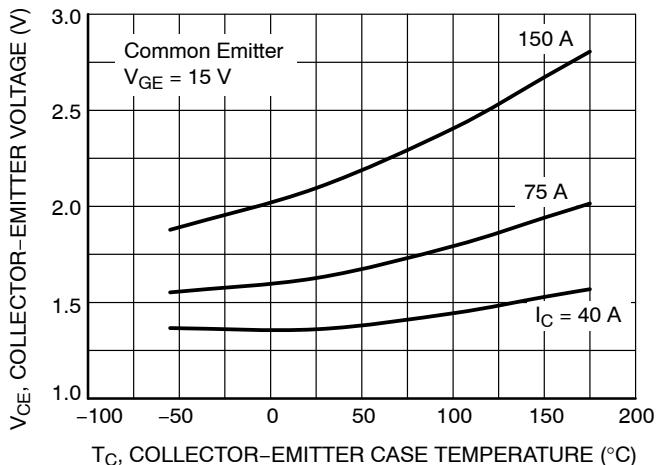

Figure 7. Saturation Voltage vs. Case Temperature at Variant Current Level

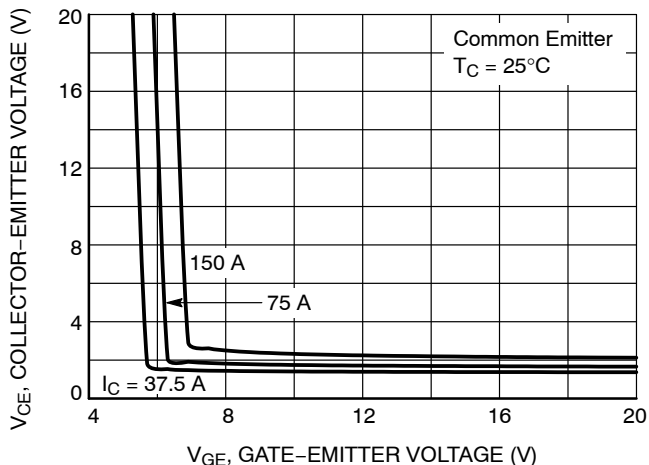

Figure 8. Saturation Voltage vs. V<sub>GE</sub> (T<sub>C</sub> = 25°C)

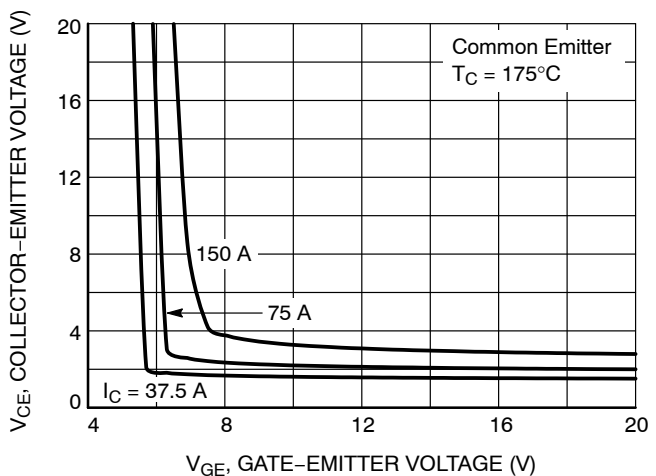

Figure 9. Saturation Voltage vs. V<sub>GE</sub> (T<sub>C</sub> = 175°C)

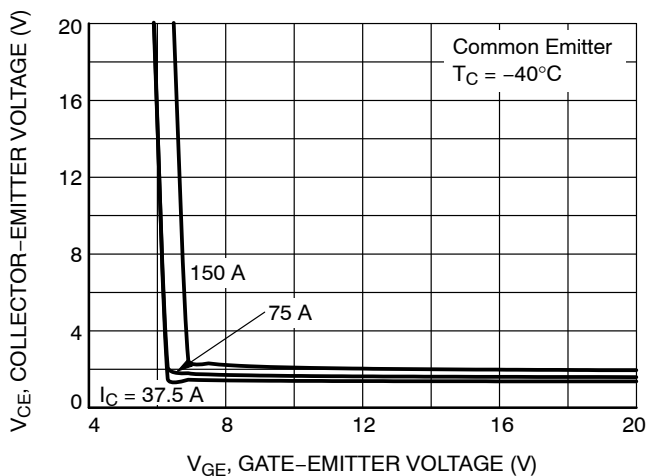

Figure 10. Saturation Voltage vs. V<sub>GE</sub> (T<sub>C</sub> = -40°C)

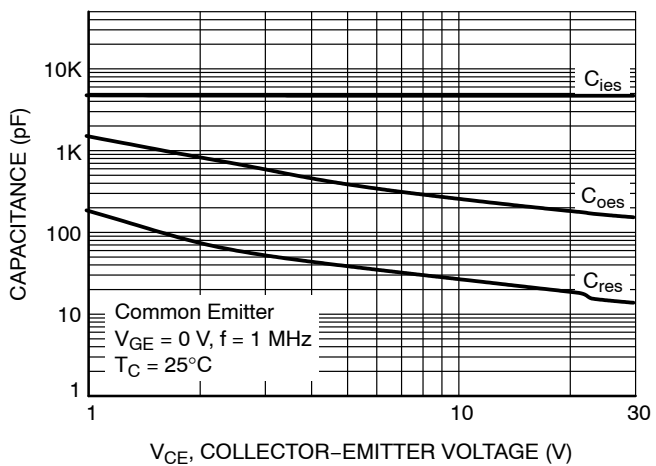

Figure 11. Capacitance Characteristics

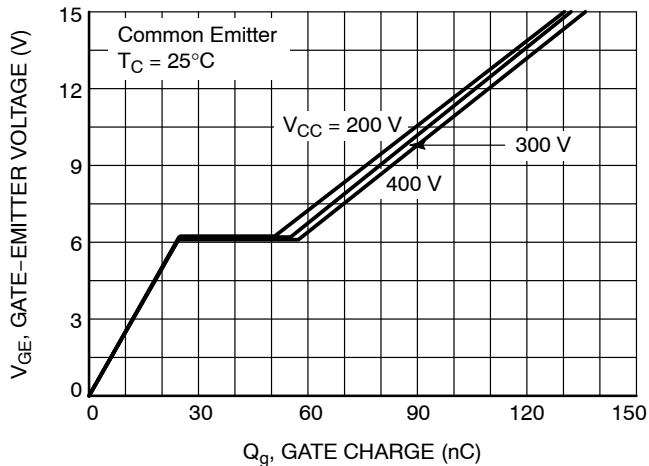

Figure 12. Gate Charge Characteristic (T<sub>C</sub> = 25°C)

TYPICAL CHARACTERISTICS

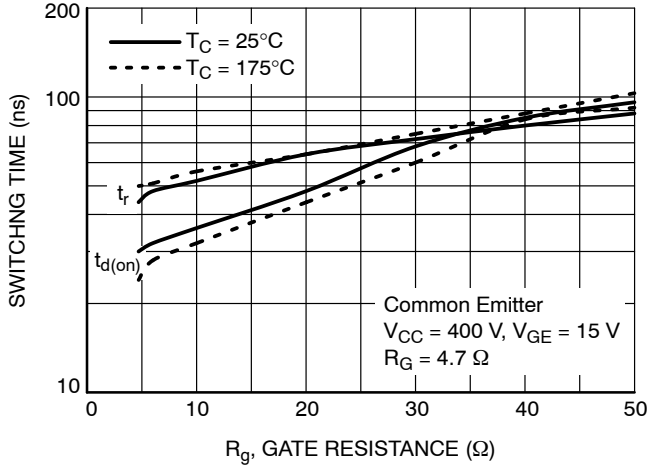

Figure 13. Turn-On Characteristics vs. Gate Resistance

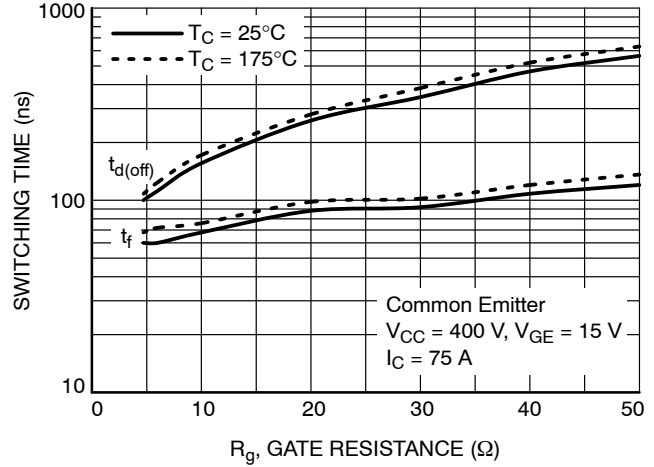

Figure 14. Turn-Off Characteristics vs. Gate Resistance

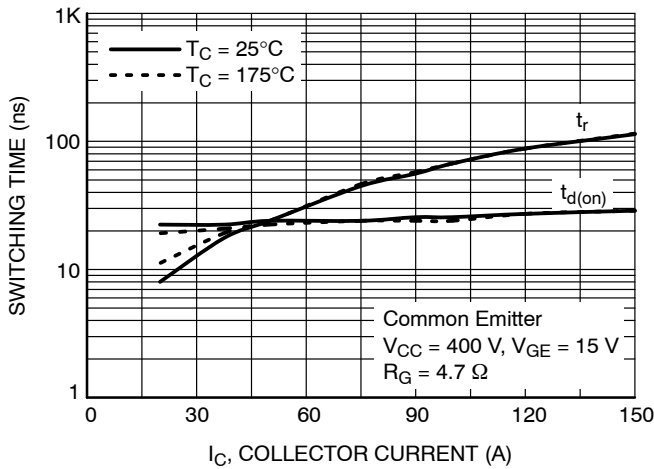

Figure 15. Turn-On Characteristics vs. Collector Current

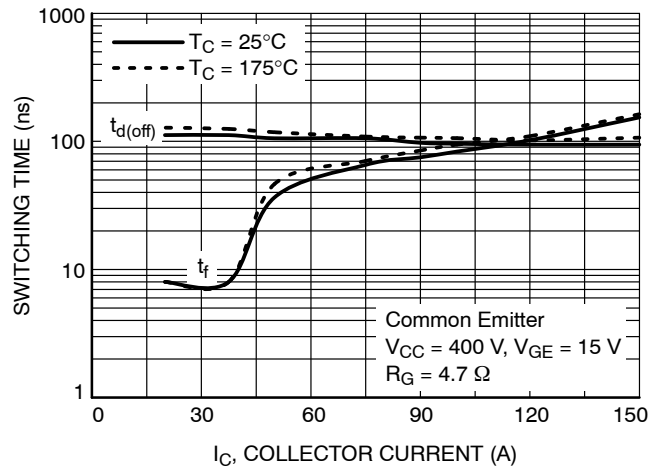

Figure 16. Turn-Off Characteristics vs. Collector Current

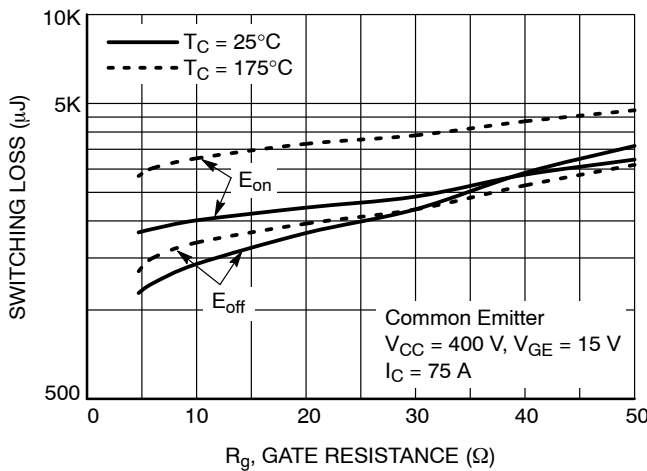

Figure 17. Switching Loss vs. Gate Resistance

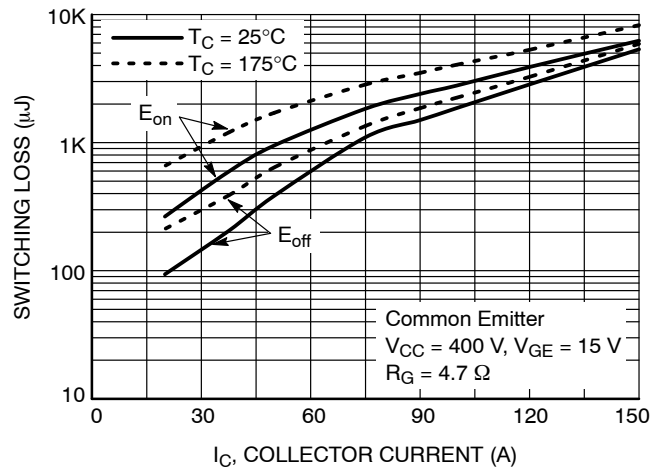

Figure 18. Switching Loss vs. Collector Current

# AFGHL75T65SQ

## TYPICAL CHARACTERISTICS

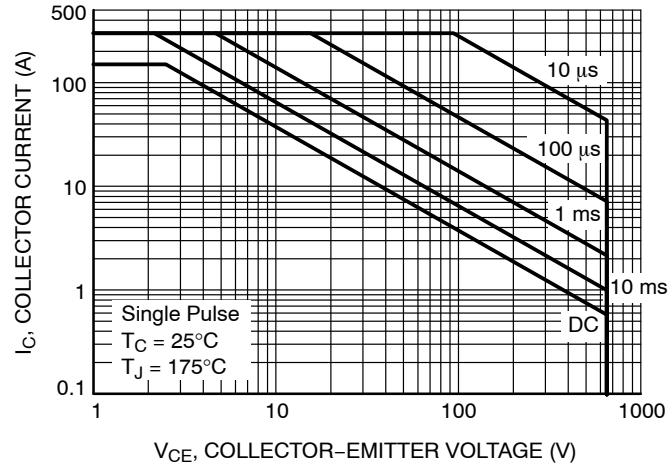

Figure 19. SOA Characteristics (FBSOA)

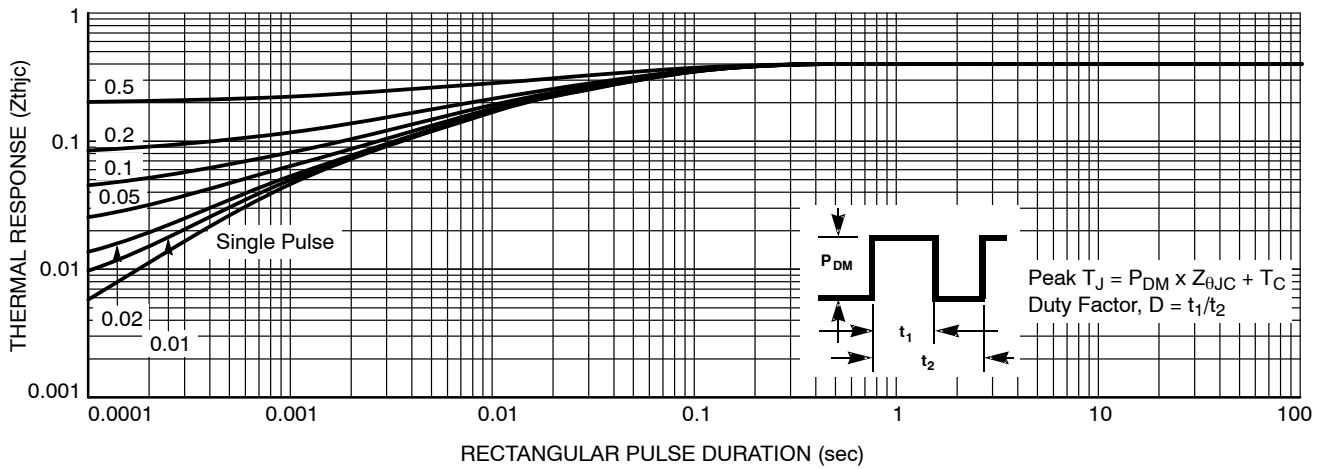

Figure 20. Transient Thermal Impedance of IGBT



# AFGHL75T65SQ

## PACKAGE DIMENSIONS

TO-247-3LD  
CASE 340CX  
ISSUE O

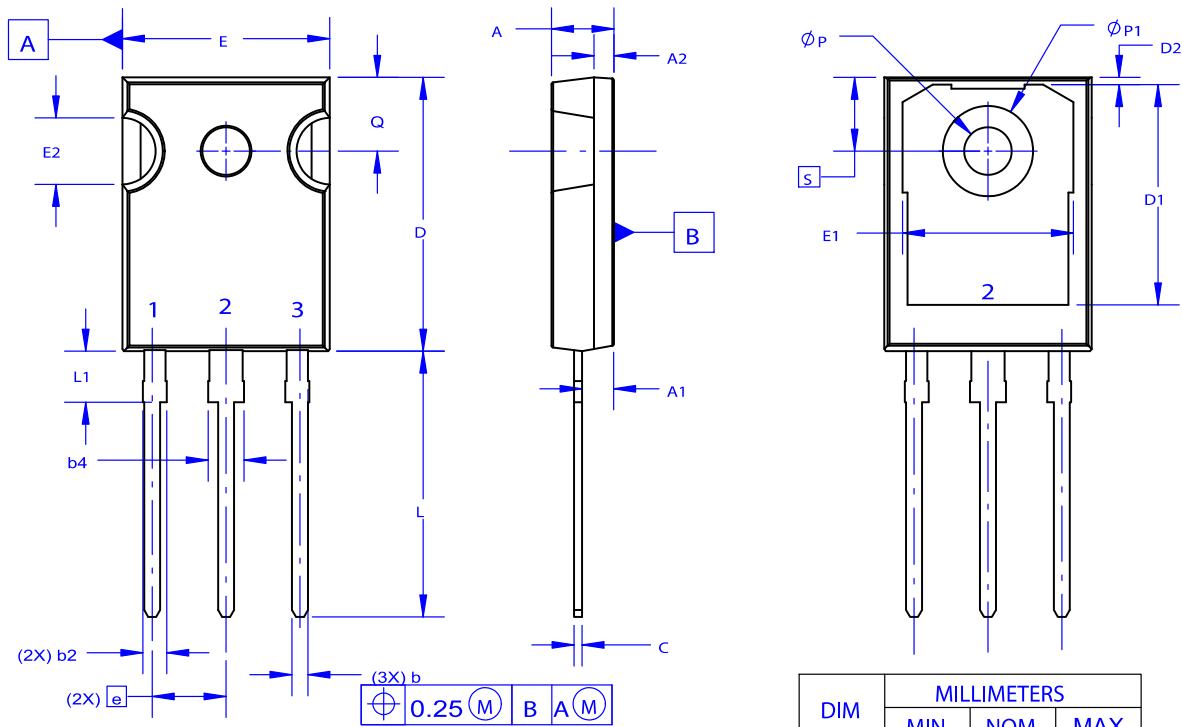

NOTES: UNLESS OTHERWISE SPECIFIED.

- A. DIMENSIONS ARE EXCLUSIVE OF BURRS, MOLD FLASH, AND TIE BAR EXTRUSIONS.
- B. ALL DIMENSIONS ARE IN MILLIMETERS.
- C. DRAWING CONFORMS TO ASME Y14.5 - 2009.
- D. DIMENSION A1 TO BE MEASURED IN THE REGION DEFINED BY L1.
- E. LEAD FINISH IS UNCONTROLLED IN THE REGION DEFINED BY L1.

| DIM    | MILLIMETERS |       |       |
|--------|-------------|-------|-------|
|        | MIN         | NOM   | MAX   |
| A      | 4.58        | 4.70  | 4.82  |
| A1     | 2.20        | 2.40  | 2.60  |
| A2     | 1.40        | 1.50  | 1.60  |
| D      | 20.32       | 20.57 | 20.82 |
| E      | 15.37       | 15.62 | 15.87 |
| E2     | 4.96        | 5.08  | 5.20  |
| e      | ~           | 5.56  | ~     |
| L      | 19.75       | 20.00 | 20.25 |
| L1     | 3.69        | 3.81  | 3.93  |
| phi P  | 3.51        | 3.58  | 3.65  |
| Q      | 5.34        | 5.46  | 5.58  |
| S      | 5.34        | 5.46  | 5.58  |
| b      | 1.17        | 1.26  | 1.35  |
| b2     | 1.53        | 1.65  | 1.77  |
| b4     | 2.42        | 2.54  | 2.66  |
| c      | 0.51        | 0.61  | 0.71  |
| D1     | 13.08       | ~     | ~     |
| D2     | 0.51        | 0.93  | 1.35  |
| E1     | 12.81       | ~     | ~     |
| phi P1 | 6.60        | 6.80  | 7.00  |

# AFGHL75T65SQ

ON Semiconductor and  are trademarks of Semiconductor Components Industries, LLC dba ON Semiconductor or its subsidiaries in the United States and/or other countries. ON Semiconductor owns the rights to a number of patents, trademarks, copyrights, trade secrets, and other intellectual property. A listing of ON Semiconductor's product/patent coverage may be accessed at [www.onsemi.com/site/pdf/Patent-Marking.pdf](http://www.onsemi.com/site/pdf/Patent-Marking.pdf). ON Semiconductor reserves the right to make changes without further notice to any products herein. ON Semiconductor makes no warranty, representation or guarantee regarding the suitability of its products for any particular purpose, nor does ON Semiconductor assume any liability arising out of the application or use of any product or circuit, and specifically disclaims any and all liability, including without limitation special, consequential or incidental damages. Buyer is responsible for its products and applications using ON Semiconductor products, including compliance with all laws, regulations and safety requirements or standards, regardless of any support or applications information provided by ON Semiconductor. "Typical" parameters which may be provided in ON Semiconductor data sheets and/or specifications can and do vary in different applications and actual performance may vary over time. All operating parameters, including "Typicals" must be validated for each customer application by customer's technical experts. ON Semiconductor does not convey any license under its patent rights nor the rights of others. ON Semiconductor products are not designed, intended, or authorized for use as a critical component in life support systems or any FDA Class 3 medical devices or medical devices with a same or similar classification in a foreign jurisdiction or any devices intended for implantation in the human body. Should Buyer purchase or use ON Semiconductor products for any such unintended or unauthorized application, Buyer shall indemnify and hold ON Semiconductor and its officers, employees, subsidiaries, affiliates, and distributors harmless against all claims, costs, damages, and expenses, and reasonable attorney fees arising out of, directly or indirectly, any claim of personal injury or death associated with such unintended or unauthorized use, even if such claim alleges that ON Semiconductor was negligent regarding the design or manufacture of the part. ON Semiconductor is an Equal Opportunity/Affirmative Action Employer. This literature is subject to all applicable copyright laws and is not for resale in any manner.

## PUBLICATION ORDERING INFORMATION

### LITERATURE FULFILLMENT:

Email Requests to: [orderlit@onsemi.com](mailto:orderlit@onsemi.com)

ON Semiconductor Website: [www.onsemi.com](http://www.onsemi.com)

### TECHNICAL SUPPORT

North American Technical Support:  
Voice Mail: 1 800-282-9855 Toll Free USA/Canada  
Phone: 011 421 33 790 2910

Europe, Middle East and Africa Technical Support:

Phone: 00421 33 790 2910

For additional information, please contact your local Sales Representative