

## 8 WATT Flange Mount GaN MMIC POWER AMPLIFIER, 2 - 20 GHz

### Typical Applications

The HMC1087F10 is ideal for

- Test Instrumentation
- General Communications
- Radar
- EW/ECM

### Functional Diagram

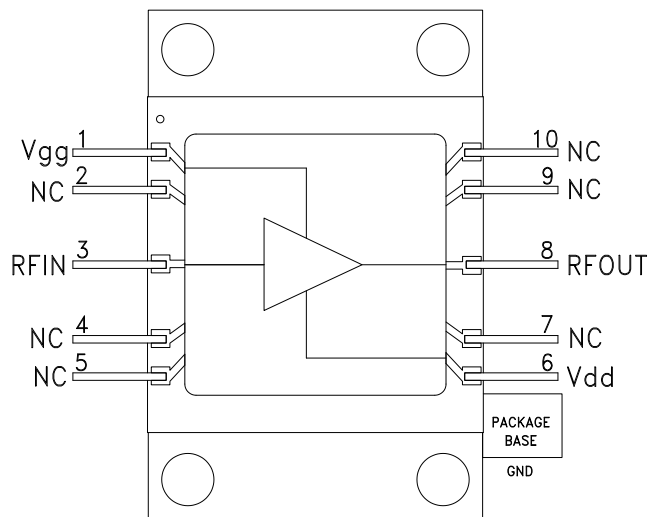

### Features

- High Psat: +38.5 dBm
- Power Gain at Psat: 6.5 dB
- High Output IP3: +43.5 dBm
- Small Signal Gain: 11 dB
- Supply Voltage: Vdd = +28V @ 850 mA
- 50 Ohm Matched Input/Output
- 10-Lead Flange Mount Package

### General Description

The HMC1087F10 is an 8W Gallium Nitride (GaN) MMIC Power Amplifier which operates between 2 and 20 GHz, and is provided in a 10-lead flange mount package. The amplifier typically provides 11 dB of small signal gain, +39 dBm of saturated output power, and +43 dBm output IP3 at +28 dBm output power per tone. The amplifier draws 850 mA quiescent current from a +28V DC supply. The RF I/Os are matched to 50 Ohms for ease of use.

### Electrical Specifications. $T_c = +25^\circ\text{C}$ . $V_{dd} = +28\text{V}$ . $I_{dd} = 850\text{ mA}$ [1]

Parameter	Min.	Typ.	Max.	Min.	Typ.	Max.	Min.	Typ.	Max.	Units
Frequency Range	2 - 12		12 - 17		17 - 20					
Gain	8	11		7.5	10.5		7	10		dB
Gain Flatness		$\pm 0.6$			$\pm 0.6$			$\pm 0.7$		dB
Gain Variation Over Temperature		0.014			0.024			0.018		dB/°C
Input Return Loss		12			12			12		dB
Output Return Loss		13			12			11		dB
Output Power for 3 dB Compression (P3dB)		38.5			37.5			37		dBm
Power Gain for 3dB compression (P3dB)		8.5			7			6		dB
Saturated Output Power (Psat)		39.5			38.5			37.5		dBm
Output Third Order Intercept (IP3) [2]		43.5			42.5			42		dBm
Power Added Efficiency		30			17			15		
Total Supply Current		850			850			850		mA

[1] Adjust Vgg between -8 to 0V to achieve Idd = 850 mA typical.

[2] Measurement taken at Pout / tone = +28 dBm.

**8 WATT Flange Mount GaN MMIC POWER AMPLIFIER, 2 - 20 GHz**

**Gain & Return Loss**

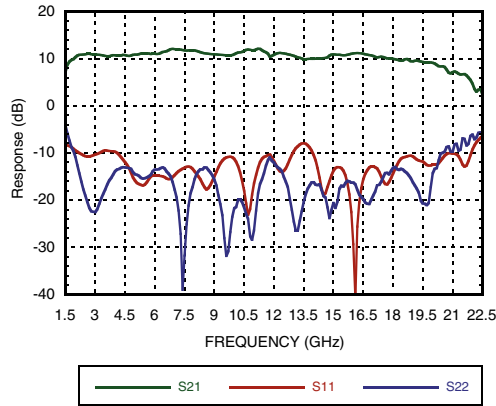

**Gain vs. Temperature**

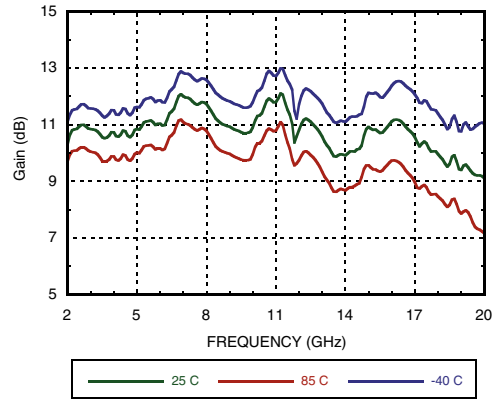

**Gain vs. Vdd**

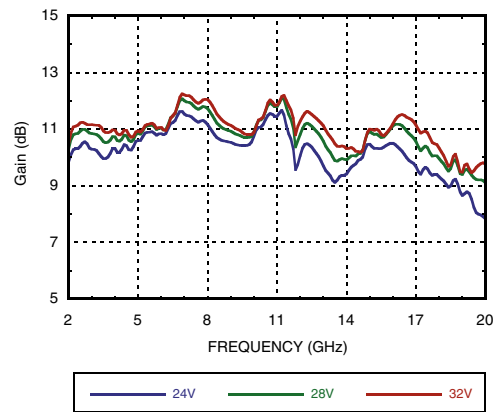

**Input Return Loss vs. Temperature**

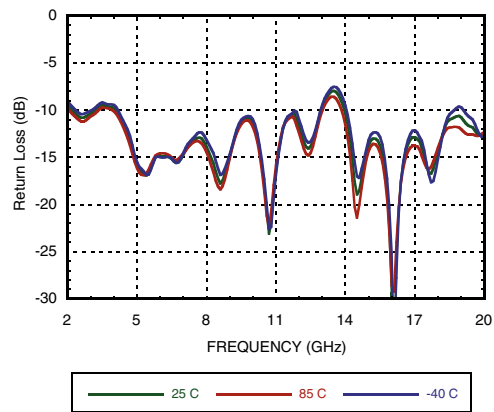

**Output Return Loss vs. Temperature**

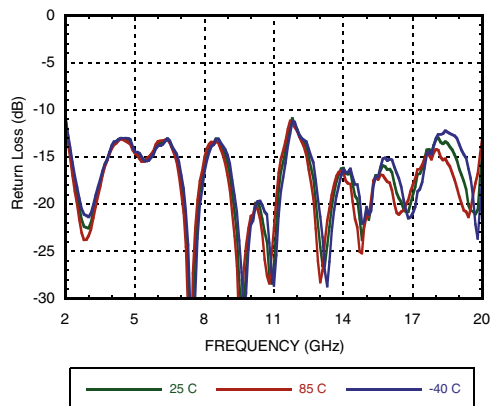

**Pout vs. Frequency**

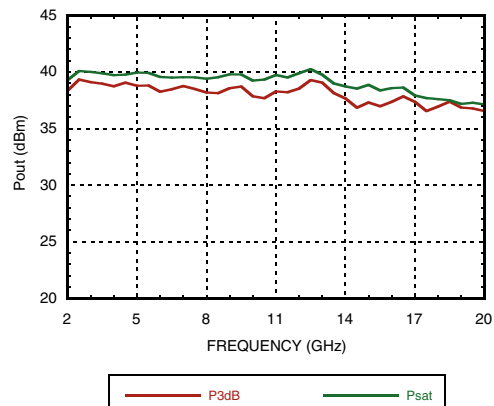

**8 WATT Flange Mount GaN MMIC  
POWER AMPLIFIER, 2 - 20 GHz**

**P3dB vs. Temperature**

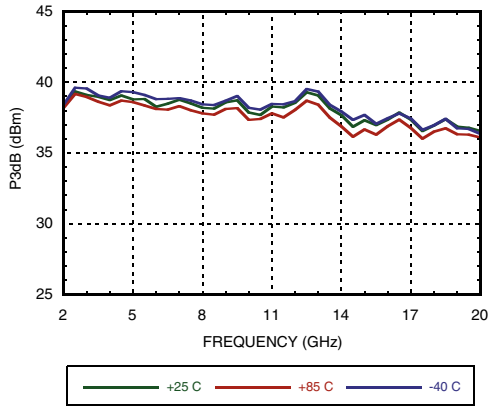

**P3dB vs. Supply Voltage**

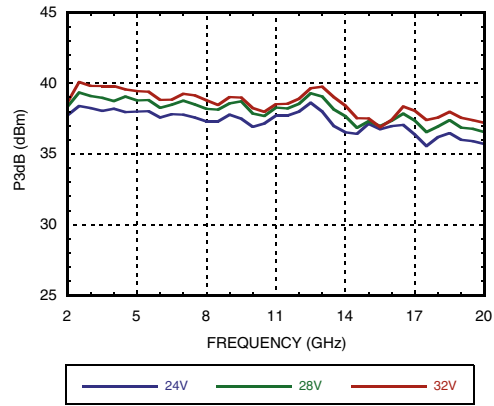

**Psat vs. Temperature**

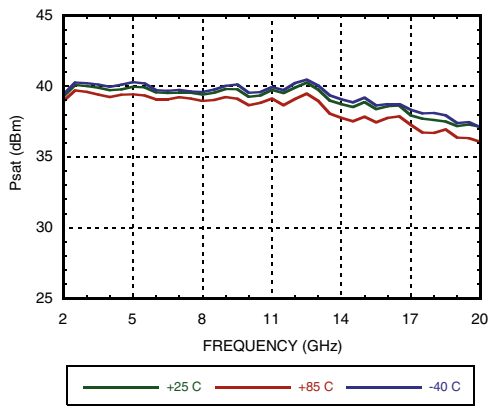

**Psat vs. Supply Voltage**

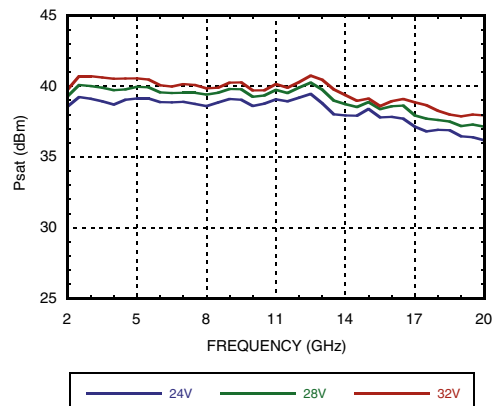

**P3dB vs. Supply Current**

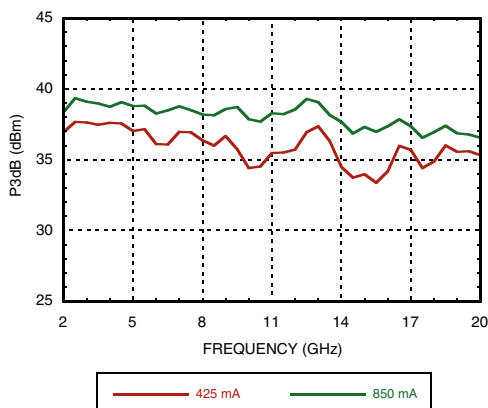

**Psat vs. Supply Current**

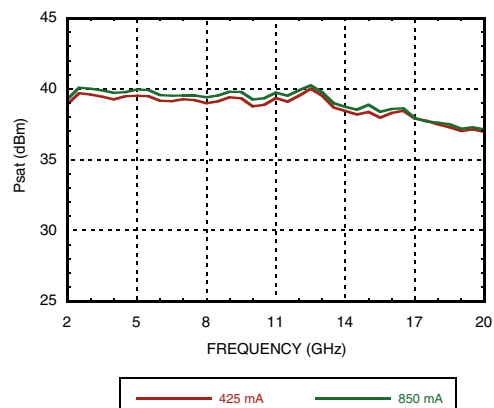

**8 WATT Flange Mount GaN MMIC  
POWER AMPLIFIER, 2 - 20 GHz**

**Power Gain vs. Frequency**

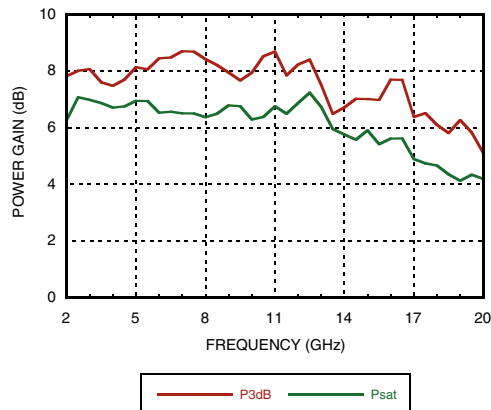

**Output IP3 vs. Temperature,  
Pout/tone = +28 dBm**

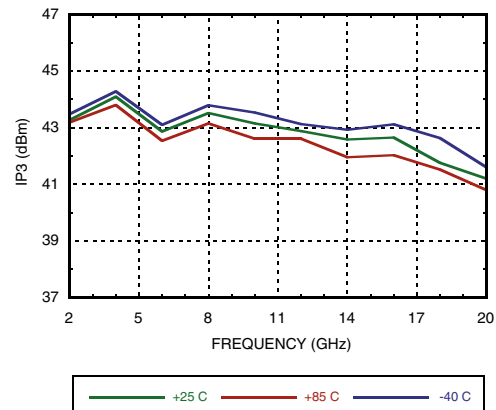

**Output IP3 vs. Supply Voltage,  
Pout/tone = +28 dBm**

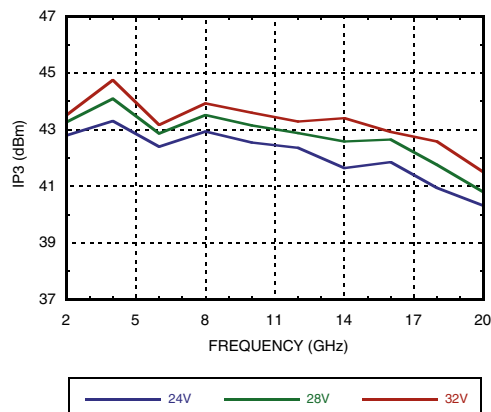

**Output IP3 vs. Supply Current,  
Pout/tone = +28 dBm**

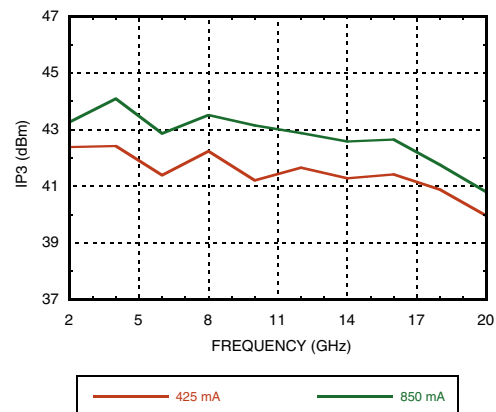

**Output IM3 @ Vdd= +24V**

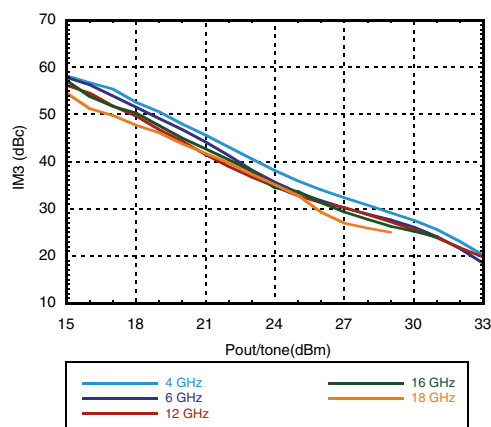

**Output IM3 @ Vdd= +28V**

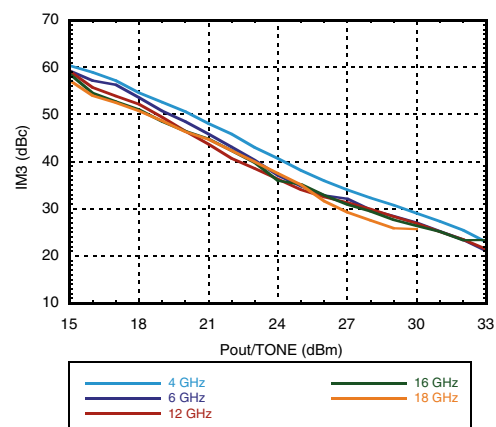

**8 WATT Flange Mount GaN MMIC  
POWER AMPLIFIER, 2 - 20 GHz**

**Output IM3 @ Vdd= +32V**

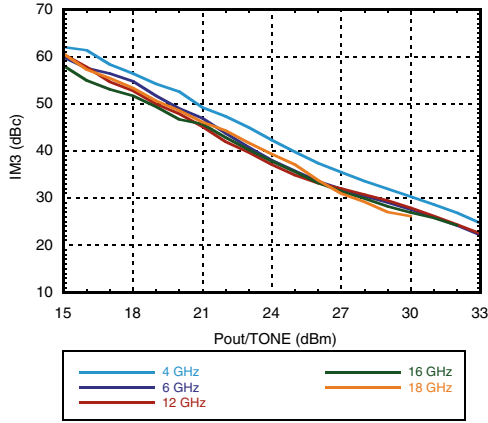

**Power Compression @ 3 GHz**

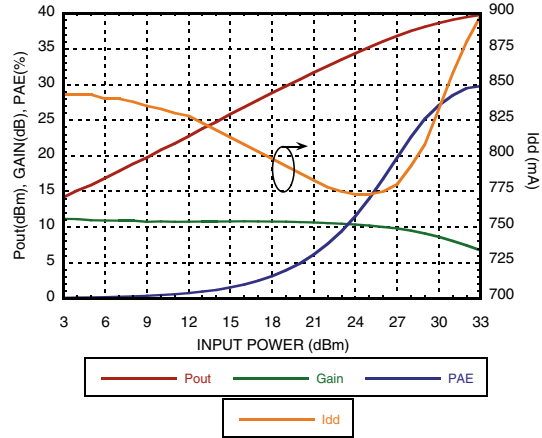

**Power Compression @ 10 GHz**

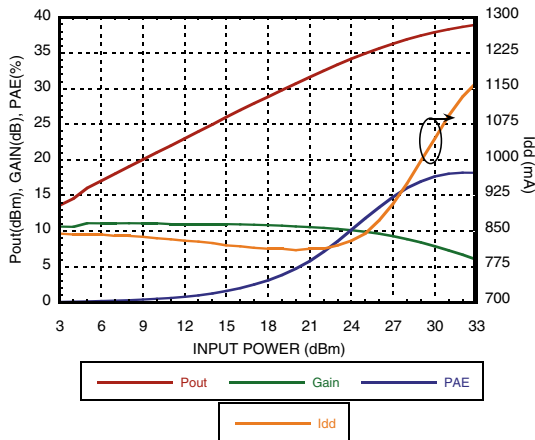

**Power Compression @ 19 GHz**

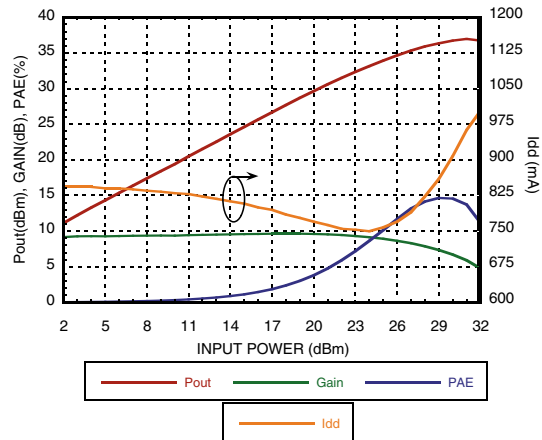

**Gain & Power vs. Supply Voltage @ 10 GHz**

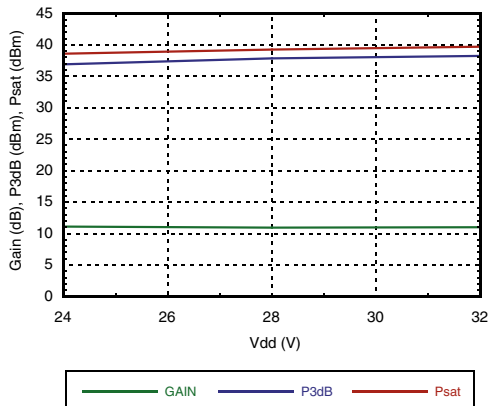

**Gain & Power vs. Supply Current @ 18 GHz**

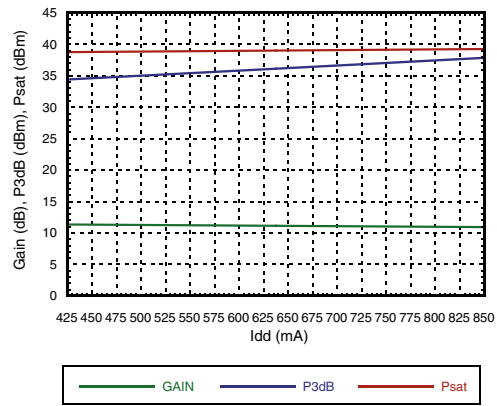

**8 WATT Flange Mount GaN MMIC  
POWER AMPLIFIER, 2 - 20 GHz**

**Reverse Isolation vs. Temperature**

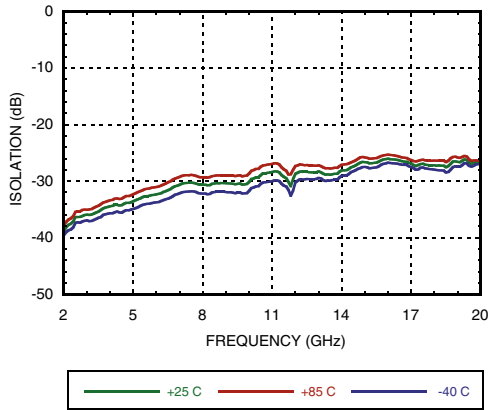

**Second Harmonics vs. Temperature [1]**

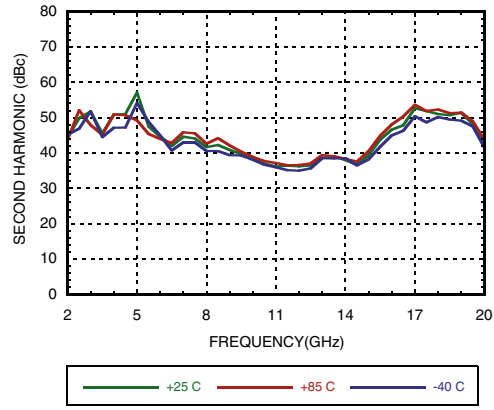

**Second Harmonics vs. Supply Voltage [1]**

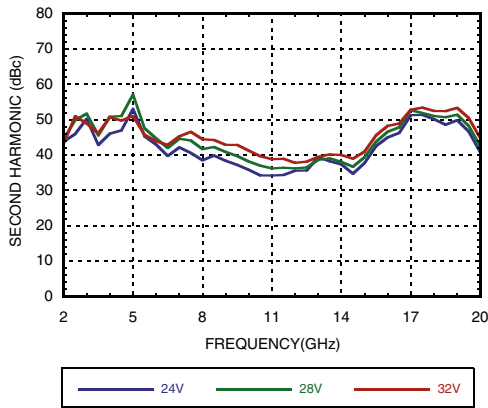

**Second Harmonics vs. Pin**

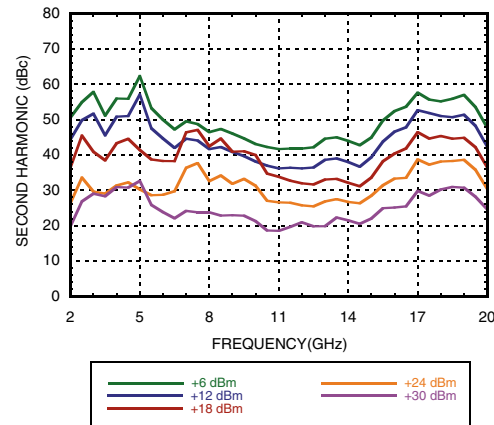

**Power Dissipation**

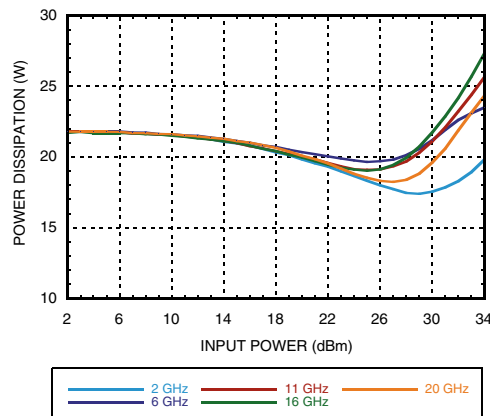

[1] Second Harmonic data Pin=12 dBm.

## 8 WATT Flange Mount GaN MMIC POWER AMPLIFIER, 2 - 20 GHz

### Absolute Maximum Ratings

Drain Bias Voltage (Vdd)	+32 Vdc
Gate Bias Voltage (Vgg)	-8 to 0 Vdc
RF Input Power (RFIN)	+34 dBm
Channel Temperature	225 °C
Maximum Pdiss (T= 85 °C) (derate 236 mW/°C above 85 °C)	33 W
Thermal Resistance (channel to flange bottom)	4.24 °C/W
Maximum Forward Gate Current (mA)	4 mA
Maximum VSWR <sup>[1]</sup>	6:1
Storage Temperature	-65 to 150°C <sup>[2]</sup>
Operating Temperature	-40 to 85 °C

[1] Restricted by maximum power dissipation.

[2] This device is not surface mountable and is not intended nor suitable to be used in a solder reflow process. This device must not be exposed to ambient temperatures above +150°C.

### Typical Supply Current vs. Vdd

Vdd (V)	Idd (mA)
+24	850
+28	850
+32	850

Adjust Vgg to achieve Idd = 850 mA

### Amplifier Turn-on Procedure:

- 1.) Set Vgg to -5V.
- 2.) Set Vdd to +28V.
- 3.) Ramp gate voltage until quiescent drain current = 850 mA.
- 4.) Apply RF input power.

### Amplifier Turn-off Procedure:

- 1.) Remove RF input power.
- 2.) Set Vgg to -5V.
- 3.) Set Vdd to 0V.
- 4.) Set Vgg to 0V.



ELECTROSTATIC SENSITIVE DEVICE  
OBSERVE HANDLING PRECAUTIONS

## 8 WATT Flange Mount GaN MMIC POWER AMPLIFIER, 2 - 20 GHz

### Outline Drawing

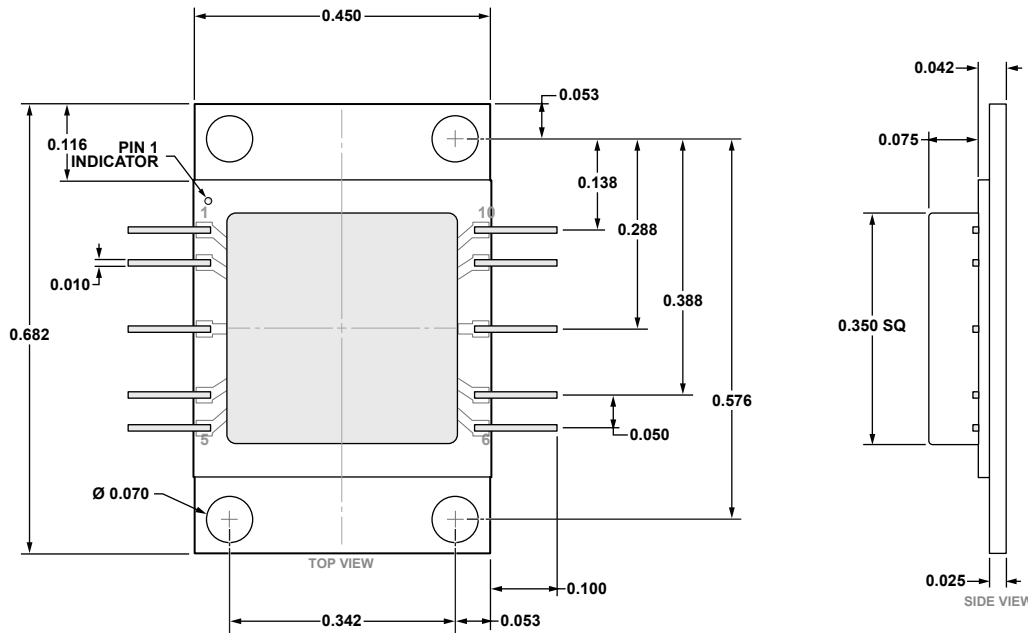

10-Lead Ceramic Leaded Chip Carrier [LDCC]  
(EJ-10-1)  
Dimensions shown in inches.

### Package Information

Part Number	Package Body Material	Lead Finish	MSL Rating	Package Marking <sup>[1]</sup>
HMC1087F10	Copper 15 Tungston 85	NiAu	N/A <sup>[2]</sup>	H1087 XXXX





[1] 4-Digit lot number XXXX

[2] This device is not rated for Moisture Sensitivity Level. The HMC1087F10 is a non-hermetic, air cavity device which is not surface mountable and is not intended nor suitable to be used in a solder reflow process.

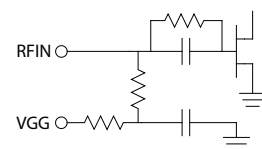
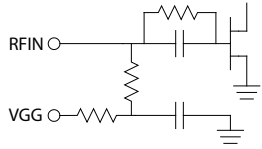

## 8 WATT Flange Mount GaN MMIC POWER AMPLIFIER, 2 - 20 GHz

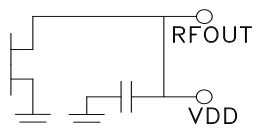
### Pin Descriptions

Pin Number	Function	Description	Interface Schematic
1	Vgg	Gate Control Voltage.	
2, 4, 5, 7, 9, 10	NC	These pins are not connected internally, however all data shown was measured with these pins connected to RF/DC ground externally.	
3	RFIN	This pad is DC coupled and is matched to 50 Ohms. External blocking capacitor is required.	
6	Vdd	Drain bias.	
8	RFOUT	This pad is DC coupled and is matched to 50 Ohms. External blocking capacitor is required.	
Package Base	GND	The package base must be mounted to a suitable heat sink for RF & DC ground. Recommended mounting screws are #0-80 socket cap screws.	

**8 WATT Flange Mount GaN MMIC  
POWER AMPLIFIER, 2 - 20 GHz**

**Application Circuit**

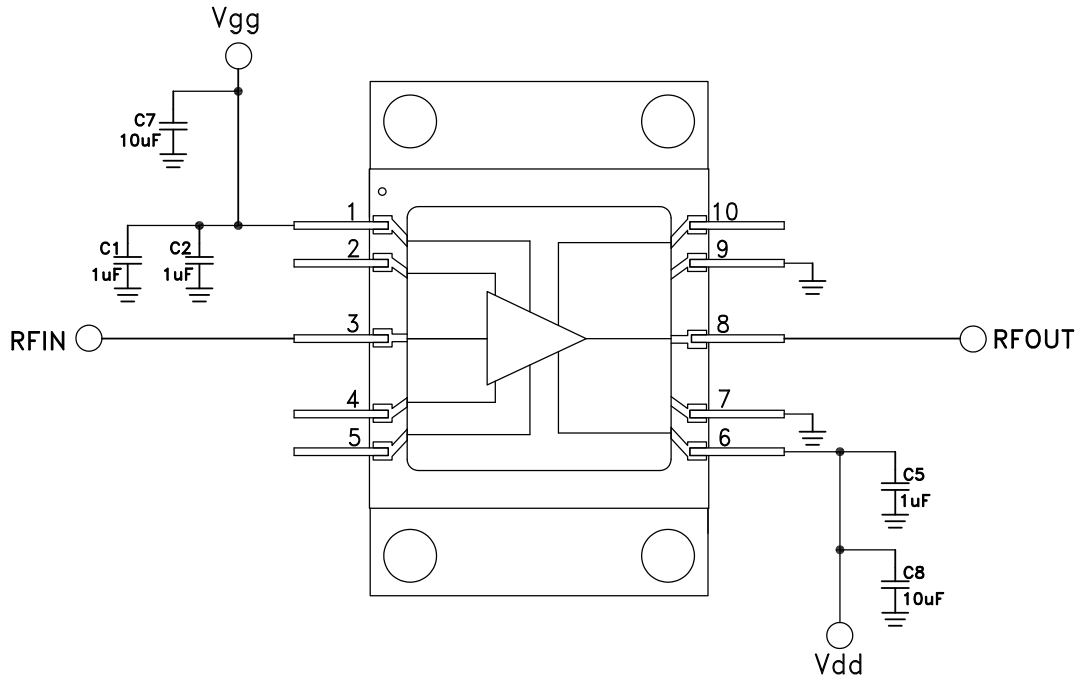

## 8 WATT Flange Mount GaN MMIC POWER AMPLIFIER, 2 - 20 GHz

### Evaluation PCB [1]

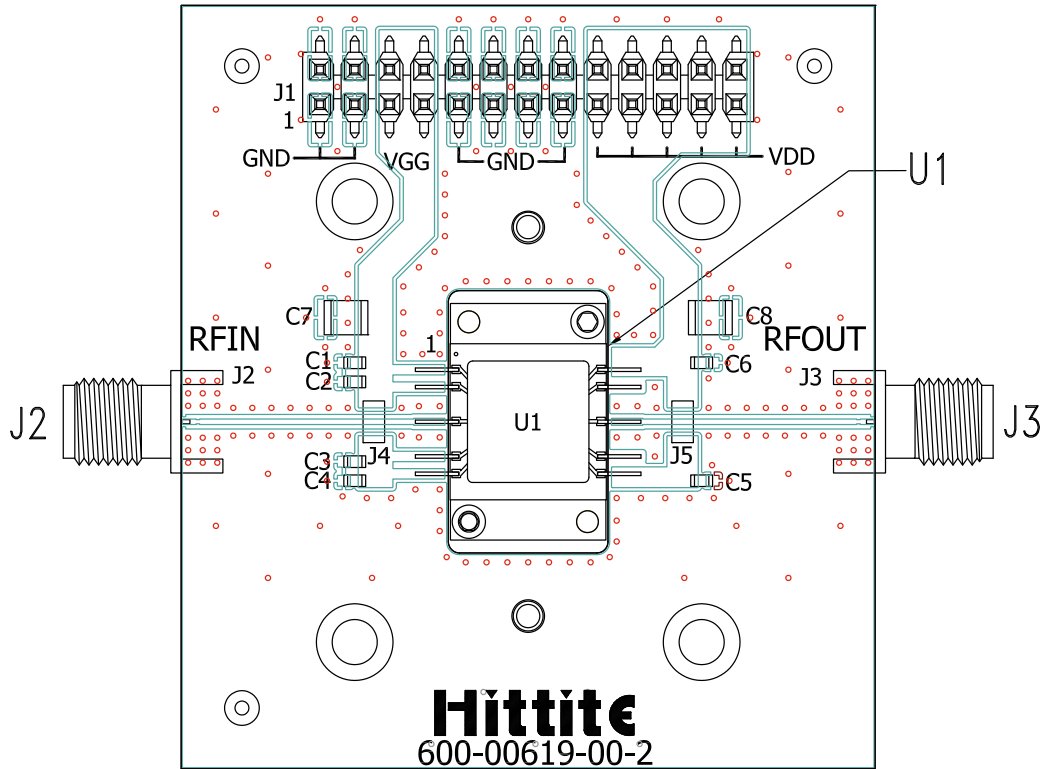

### Evaluation Order Information

Item	Contents	Part Number
Evaluation PCB Only	HMC1087F10 Evaluation PCB	EVAL01-HMC1087F10 [2]

[2] Reference this number when ordering Evaluation PCB Only

### List of Materials for Evaluation PCB EVAL01-HMC1087F10

Item	Description
J2, J3	SRI K Connector
J1	DC Connector
J4, J5	Preform jumpers
C1 - C6	1 uF Capacitor, 0602 Pkg.
C7 - C8	10 uF Capacitor, 1210 Pkg.
U1	HMC1087F10
PCB [1]	600-00619-00 Evaluation PCB.

[2] Circuit Board Material: Rogers 4350 or Arlon 25FR

The circuit board used in the application should use RF circuit design techniques. Signal lines should have 50 Ohm impedance while the package ground leads and exposed paddle should be connected directly to the ground plane similar to that shown. A sufficient number of via holes should be used to connect the top and bottom ground planes. The evaluation circuit board shown is available from Analog Devices, upon request.

[1] The universal evaluation board shown above is designed to support multiple products, please refer to Application Circuit herein for required external components.

---

**8 WATT Flange Mount GaN MMIC  
POWER AMPLIFIER, 2 - 20 GHz****Notes**