



4-Channel, Rail-to-Rail, CMOS BUFFER AMPLIFIER

FEATURES

- UNITY GAIN BUFFER
- RAIL-TO-RAIL INPUT/OUTPUT
- WIDE BANDWIDTH: 8MHz
- HIGH SLEW RATE: 10V/μs
- LOW QUIESCENT CURRENT: 1.1mA
- TINY PACKAGE: MSOP-10, TSSOP-14

APPLICATIONS

- TFT-LCD REFERENCE DRIVERS
- NOTEBOOKS
- ELECTRONIC GAMES
- ELECTRONIC BOOKS
- PERSONAL COMMUNICATION DEVICES
- PDA
- ACTIVE FILTERS
- ADC/DAC BUFFER

DESCRIPTION

The BUF04701 is a 4-channel, low-power, high-voltage rail-to-rail input/output buffer. Operating on supplies ranging from 3.5V to 12V ($\pm 1.75V$ to $\pm 6V$), the BUF04701 has a 3dB bandwidth of 8MHz with a slew rate of 10V/μs, and requires only 1.1mA quiescent current. The BUF04701 features rail-to-rail input and output capability, giving maximum dynamic range at any supply voltage.

Featuring fast slewing and settling times, as well as a high output drive, the BUF04701 is ideal for use as a voltage reference buffer in Thin Film Transistor Liquid Crystal Displays (TFT-LCDs).

The BUF04701 is available in an MSOP-10 package, providing the smallest footprint and thinnest package option available, as well as the TSSOP-14 package with a pinout that corresponds to standard quad op amps. This makes it easy to replace quad op amps in existing LCD displays with the low cost BUF04701, without changing the layout. The BUF04701 operates over a temperature range of $-40^{\circ}C$ to $+125^{\circ}C$.

BUF04701 RELATED PRODUCTS

FEATURES	PRODUCT
1.2 MHz BW, 3.3mA I_Q	BUF11702
7MHz GBW, 1.5mA I_Q , V_S 3.5 - 12	OPA4743
5.9MHz GBW, 4.5mA I_Q , V_S = 4V - 44V	TLE2144/2
10MHz GBW, 2.5mA I_Q , 16V/μs SR	TLC084

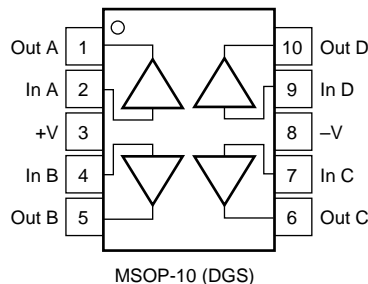
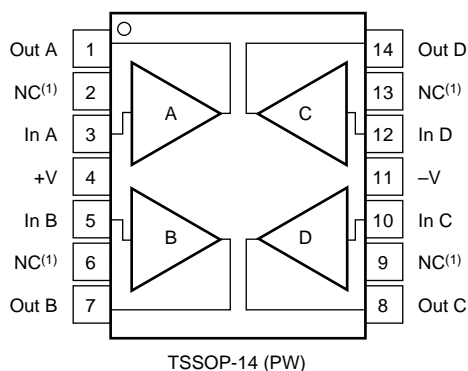

NOTE: (1) NC Means No Internal Connection



Please be aware that an important notice concerning availability, standard warranty, and use in critical applications of Texas Instruments semiconductor products and disclaimers thereto appears at the end of this data sheet.

All trademarks are the property of their respective owners.

ABSOLUTE MAXIMUM RATINGS⁽¹⁾

Supply Voltage, V+ to V-	13.2V
Signal Input Terminals, Voltage ⁽²⁾	(V-) -0.5V to (V+) + 0.5V
Current ⁽²⁾	10mA
Output Short-Circuit ⁽³⁾	Continuous
Operating Temperature	-40°C to +125°C
Storage Temperature	-65°C to +150°C
Junction Temperature	+150°C
Lead Temperature (soldering, 10s)	+300°C

NOTES: (1) Stresses above these ratings may cause permanent damage. Exposure to absolute maximum conditions for extended periods may degrade device reliability. (2) Input terminals are diode-clamped to the power-supply rails. Input signals that can swing more than 0.5V beyond the supply rails should be current-limited to 10mA or less. (3) Short-circuit to ground, one amplifier per package.



ELECTROSTATIC DISCHARGE SENSITIVITY

This integrated circuit can be damaged by ESD. Texas Instruments recommends that all integrated circuits be handled with appropriate precautions. Failure to observe proper handling and installation procedures can cause damage.

ESD damage can range from subtle performance degradation to complete device failure. Precision integrated circuits may be more susceptible to damage because very small parametric changes could cause the device not to meet its published specifications.

PACKAGE/ORDERING INFORMATION⁽¹⁾

PRODUCT	PACKAGE-LEAD	PACKAGE DESIGNATOR	SPECIFIED TEMPERATURE RANGE	PACKAGE MARKING	ORDERING NUMBER	TRANSPORT MEDIA, QUANTITY
Quad						
BUF04701	MSOP-10	DGS	-40°C to +125°C	BUF04701	BUF04701AIDGSR	Tape and Reel, 2500
BUF04701	TSSOP-14	PW	-40°C to +125°C	04701A	BUF04701AIPWR	Tape and Reel, 2500

NOTE: (1) For the most current package and ordering information, see the Package Option Addendum located at the end of this data sheet.

ELECTRICAL CHARACTERISTICS: $V_S = +3.5V$ to $+12V$

Boldface limits apply over the specified temperature range, $T_A = -40^\circ\text{C}$ to $+125^\circ\text{C}$

At $T_A = +25^\circ\text{C}$, $R_L = 10\text{k}\Omega$ connected to $V_S/2$ and $V_{OUT} = V_S/2$, unless otherwise noted.

PARAMETER	CONDITION	BUF04701			UNITS
		MIN	TYP	MAX	
OFFSET VOLTAGE Input Offset Voltage V_{OS} Drift dV_{OS}/dT vs Power Supply PSRR Over Temperature Channel Separation, DC $f = 10\text{kHz}$	$V_S = \pm 5, V_{CM} = 0$ $V_S = 3.5V$ to $12V, V_{CM} = V_S/2 - 0.5V$ $V_S = 3.5V$ to $12V, V_{CM} = V_S/2 - 0.5V$		± 1.5 ± 8 20 1 110	± 7 100 200	mV $\mu\text{V}/^\circ\text{C}$ $\mu\text{V}/\text{V}$ $\mu\text{V}/\text{V}$ $\mu\text{V}/\text{V}$ dB
INPUT VOLTAGE RANGE Common-Mode Voltage Range V_{CM}		Limited by Output Range			
INPUT BIAS CURRENT Input Bias Current I_B	$V_{CM} = V_S/2$		1	± 10	pA
INPUT IMPEDANCE Common-Mode			$5 \cdot 10^{12} \parallel 4$		$\Omega \parallel \text{pF}$
NOISE Input Voltage Noise, $f = 0.1\text{Hz}$ to 10Hz Input Voltage Noise Density, $f = 10\text{kHz}$ e_n Input Current Noise Density, $f = 1\text{kHz}$ i_n	$V_S = \pm 6V, V_{CM} = 0$ $V_S = \pm 6V, V_{CM} = 0$ $V_S = \pm 6V, V_{CM} = 0$		11 30 2.5		μVrms $\text{nV}/\sqrt{\text{Hz}}$ $\text{fA}/\sqrt{\text{Hz}}$
TRANSFER CHARACTERISTIC Gain over Temperature		0.9975 0.995	1.000 1.000	1.0025 1.005	
OUTPUT Voltage Output Swing from Rail over Temperature Short-Circuit Current I_{SC}	$R_L = 10\text{k}\Omega$ $R_L = 2\text{k}\Omega$ $R_L = 2\text{k}\Omega$		75 150 ± 32	200 250	mV mV mV mA
FREQUENCY RESPONSE Bandwidth -3dB BW Slew Rate SR Settling Time, 0.1% t_s Overload Recovery Time Total Harmonic Distortion + Noise THD+N	$C_L = 10\text{pF}$ $V_S = \pm 6V$ $V_S = \pm 6V, 5V$ Step $V_{IN} = V_S$ $V_S = \pm 6V, V_O = 1\text{Vrms}, G = 1,$ $f = 6\text{kHz}, V_{CM} = V_S/2$		8 10 9 0.2 0.001		MHz $\text{V}/\mu\text{s}$ μs μs %
POWER SUPPLY Specified Voltage Range, Single Supply V_S Specified Voltage Range, Dual Supplies Operating Voltage Range Quiescent Current (per amplifier) I_Q over Temperature	$I_Q = 0$	3.5 ± 1.75	$+3.5$ to $+12$ 1.1	12 ± 6 1.5 1.7	V V V mA mA
TEMPERATURE RANGE Specified Range Operating Range Storage Range Thermal Resistance θ_{JA} TSSOP Surface Mount MSOP Surface Mount		-40 -40 -65		+125 +125 +150	$^\circ\text{C}$ $^\circ\text{C}$ $^\circ\text{C}$ $^\circ\text{C}/\text{W}$ $^\circ\text{C}/\text{W}$

TYPICAL CHARACTERISTICS

At $T_A = +25^\circ\text{C}$, $V_S = \pm 6\text{V}$, and $R_L = 10\text{k}\Omega$, unless otherwise noted.

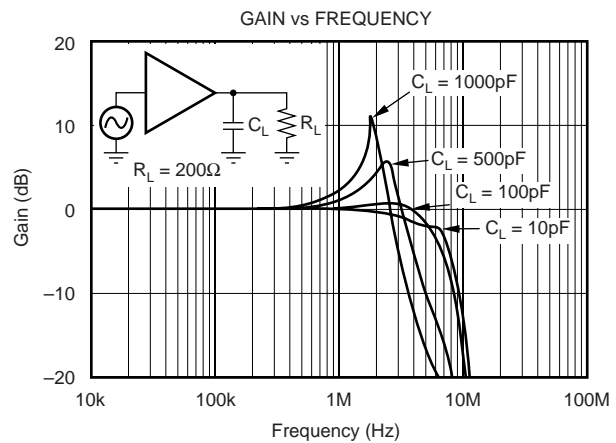
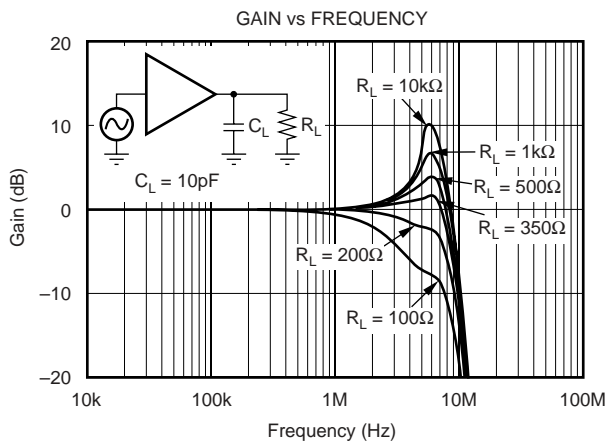
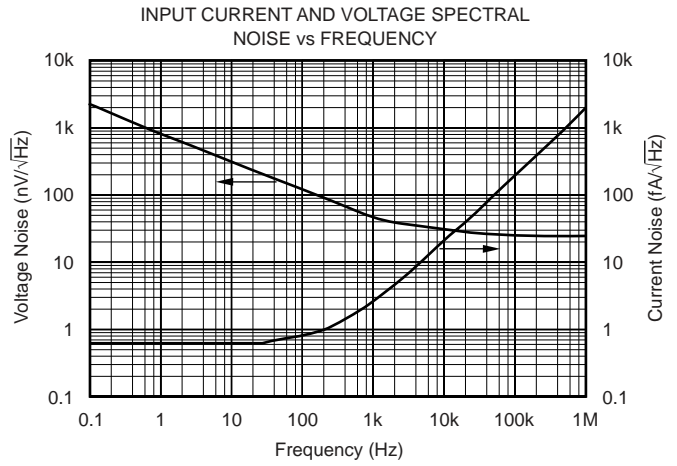
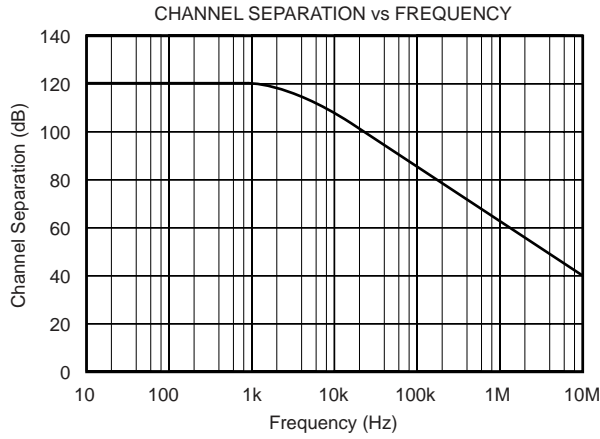
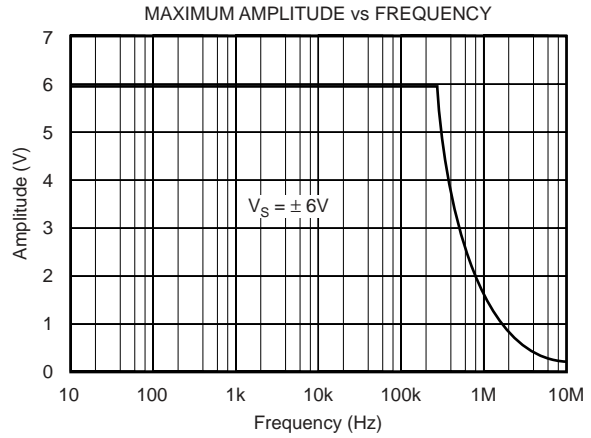
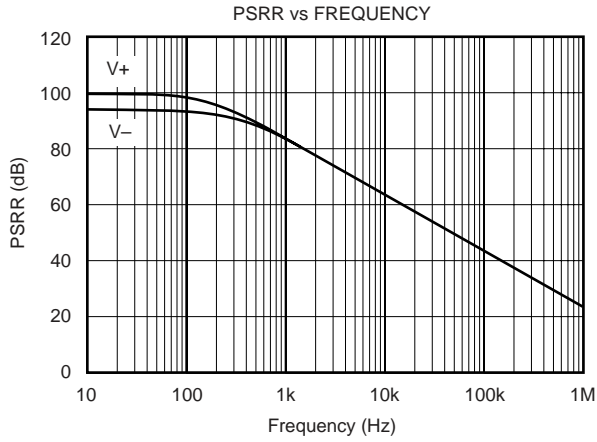

TYPICAL CHARACTERISTICS (Cont.)

At $T_A = +25^\circ\text{C}$, $V_S = \pm 6\text{V}$, and $R_L = 10\text{k}\Omega$, unless otherwise noted.

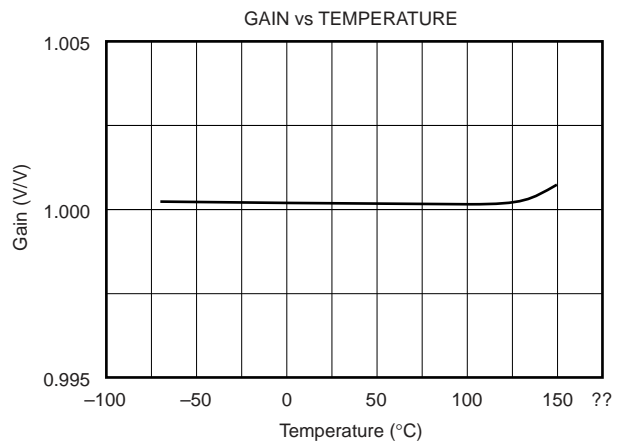
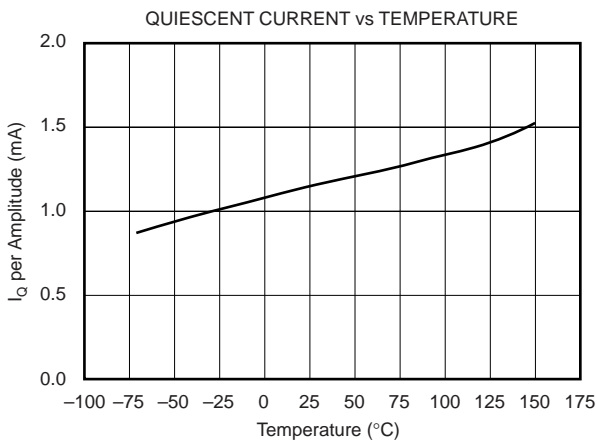
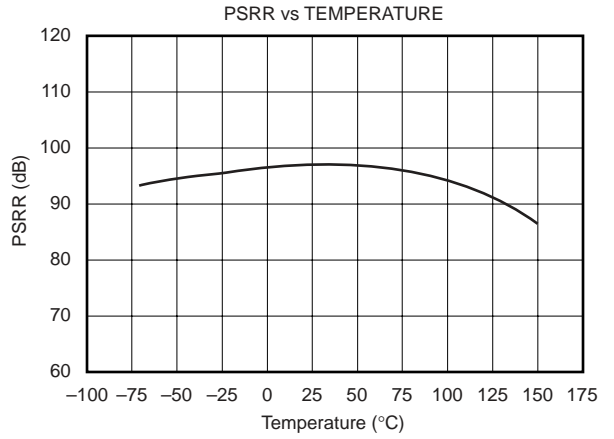
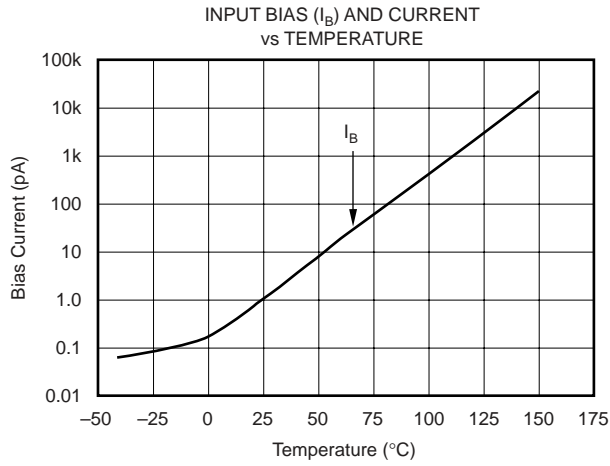
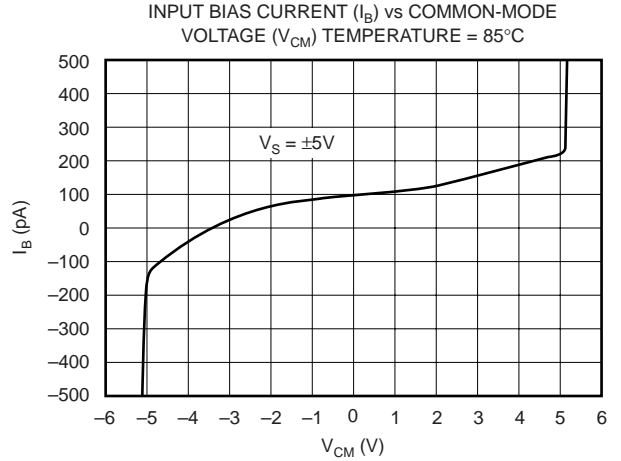
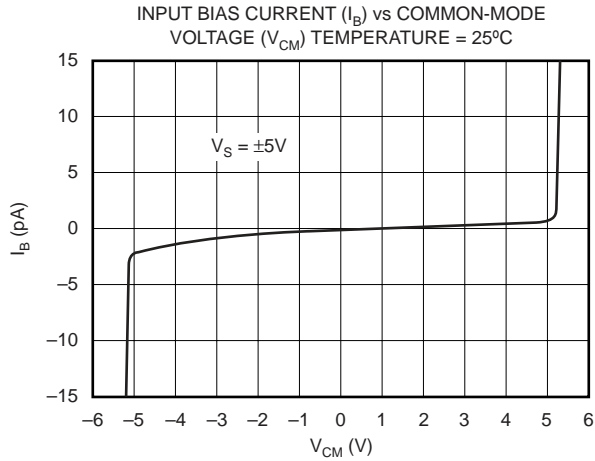

TYPICAL CHARACTERISTICS (Cont.)

At $T_A = +25^\circ\text{C}$, $V_S = \pm 6\text{V}$, and $R_L = 10\text{k}\Omega$, unless otherwise noted.

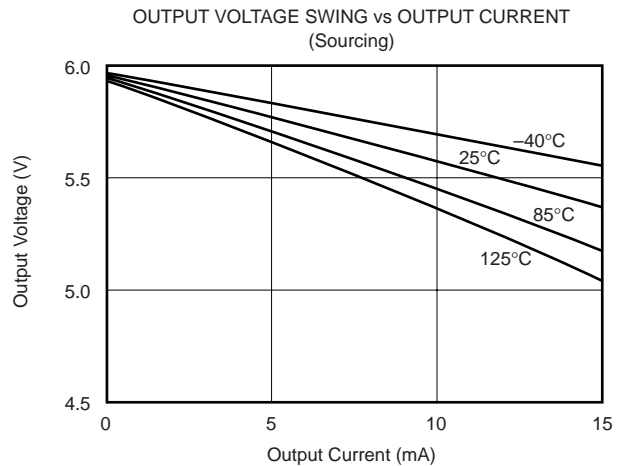
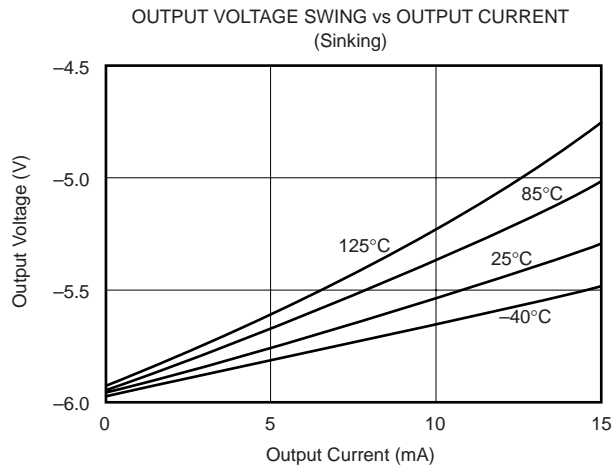
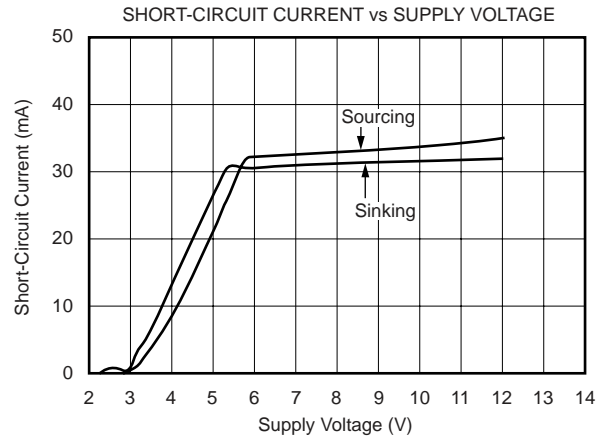
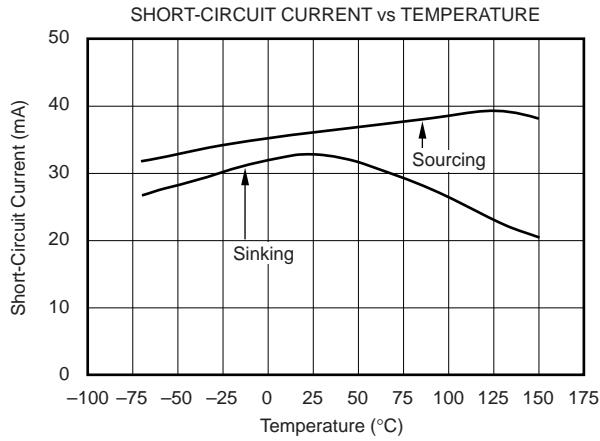
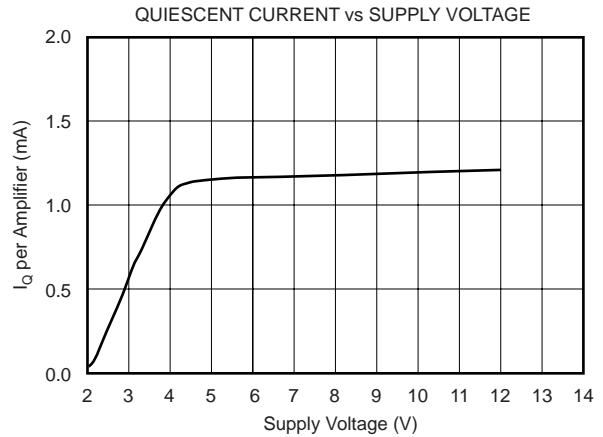
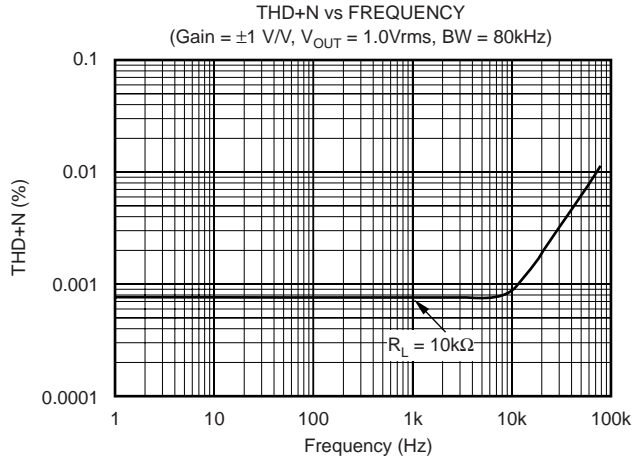

TYPICAL CHARACTERISTICS (Cont.)

At $T_A = +25^\circ\text{C}$, $V_S = \pm 6\text{V}$, and $R_L = 10\text{k}\Omega$, unless otherwise noted.

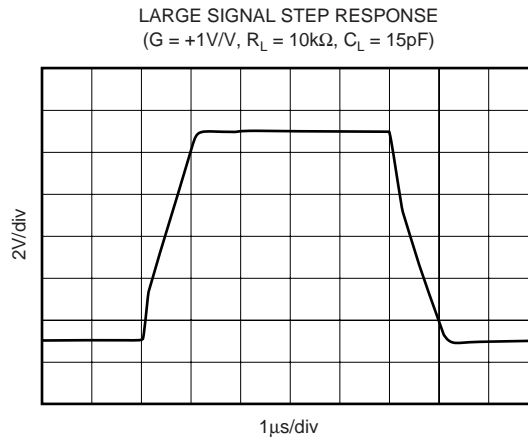
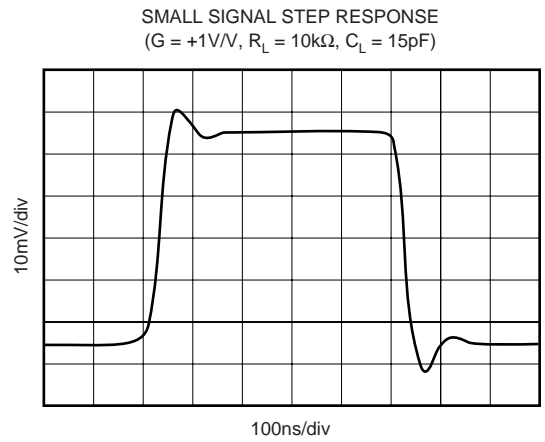
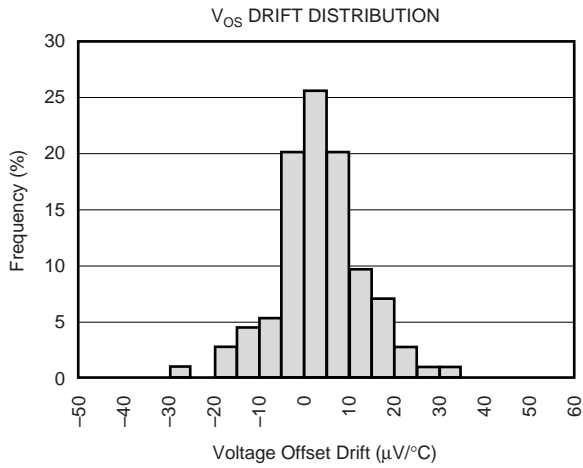
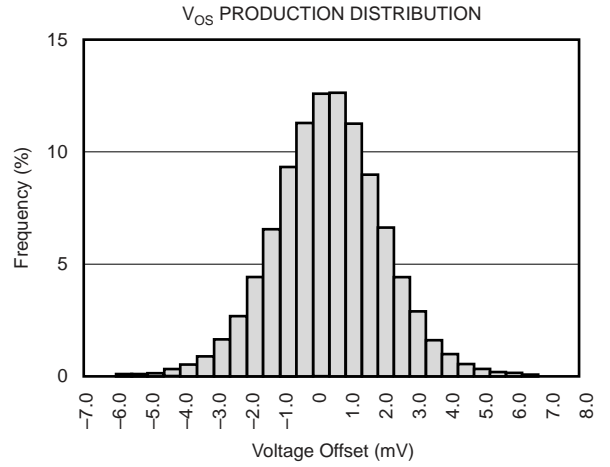
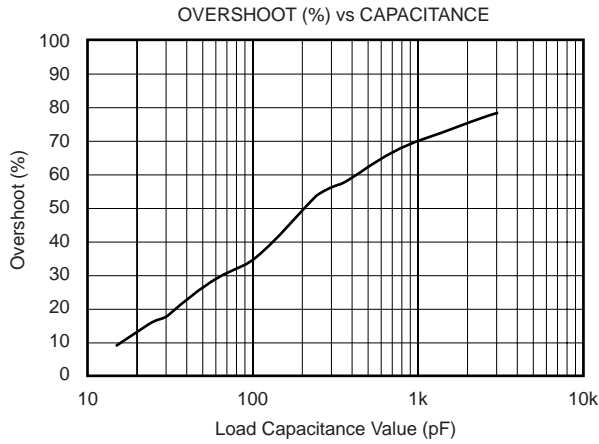

APPLICATIONS INFORMATION

Figure 1 shows the BUF04701 connected as a buffer. Power supplies should be bypassed with capacitors connected close to the device pins. Capacitor values as low as 0.1 μ F will assure stable operation in most applications, but high output current and fast output slewing can demand large current transients from the power supplies.

Rail-to-rail input and output swing helps maintain dynamic range, especially in low supply applications. Figure 2 shows the input and output waveforms for the BUF04701. On a ± 6 V supply with a 100k Ω load connected to $V_S/2$, the output is tested to swing within 50mV to the rail.

OPERATING VOLTAGE

The BUF04701 is fully specified and tested from 3.5V to 12V over a temperature range of -40°C to $+125^\circ\text{C}$. Parameters that vary significantly with operating voltages or temperature are shown in the Typical Characteristic Curves.

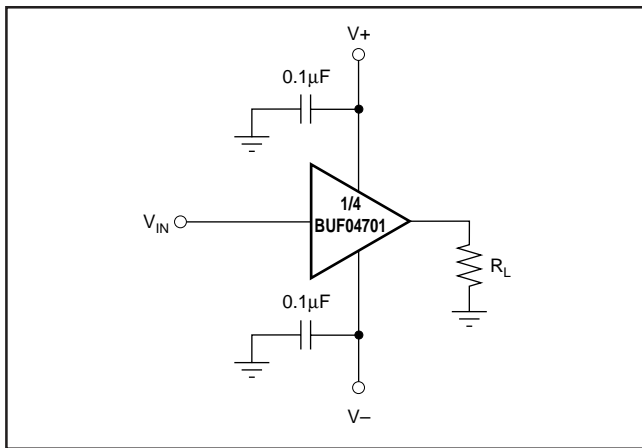

FIGURE 1. Basic Connections.

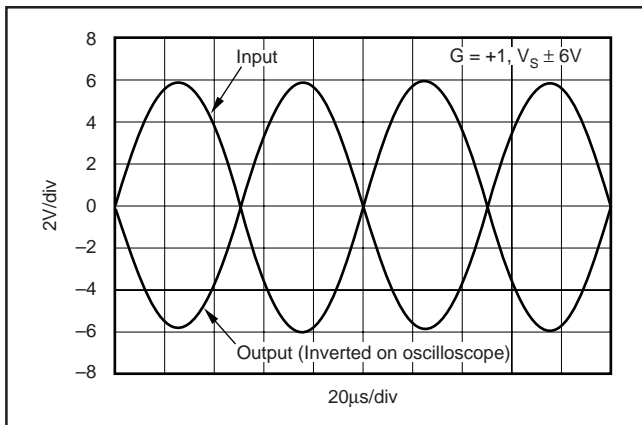

FIGURE 2. Rail-to-Rail Input and Output.

RAIL-TO-RAIL INPUT

The input common-mode voltage range of the BUF04701 extends 100mV beyond the supply rails at room temperature; however, due to the fixed gain at $G = 1$, the output will limit the useable input range. This wide swing is achieved with a complementary input stage—an N-channel input differential pair in parallel with a P-channel differential pair. The N-channel pair is active for input voltages close to the positive rail, typically $(V+) - 2.0\text{V}$ to 100mV above the positive supply, while the P-channel pair is on for inputs from 100mV below the negative supply to approximately $(V+) - 1.5\text{V}$. There is a small transition region, typically $(V+) - 2.0\text{V}$ to $(V+) - 1.5\text{V}$, in which both pairs are on. This 500mV transition region can vary $\pm 100\text{mV}$ with process variation. Thus, the transition region (both stages on) can range from $(V+) - 2.1\text{V}$ to $(V+) - 1.4\text{V}$ on the low end, up to $(V+) - 1.9\text{V}$ to $(V+) - 1.6\text{V}$ on the high end.

INPUT PROTECTION

Device inputs are protected by ESD diodes that will conduct if the input voltages exceed the power supplies by more than approximately 300mV. Momentary voltages greater than 300mV beyond the power supply can be tolerated if the current is limited to 10mA. This is easily accomplished with an input resistor, in series with the buffer input shown in Figure 3. Many input signals are inherently current-limited to less than 10mA; therefore, a limiting resistor is not always required. The BUF04701 features no phase inversion when the inputs extend beyond supplies if the input current is limited, as shown in Figure 4.

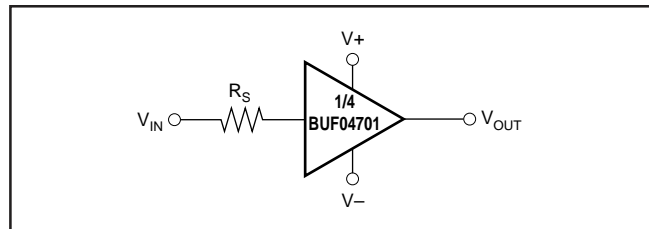

FIGURE 3. Limiting Input Current on the BUF04701.

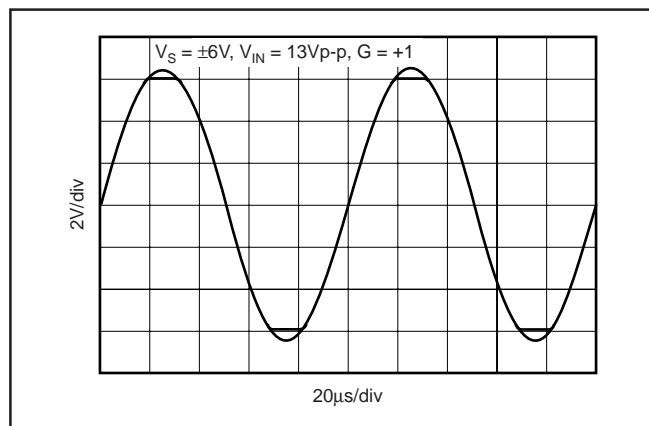

FIGURE 4. BUF04701—No Phase Inversion with Inputs Greater than the Power-Supply Voltage.

RAIL-TO-RAIL OUTPUT

A class AB output stage with common-source transistors is used to achieve rail-to-rail output. This output stage is capable of driving $1\text{k}\Omega$ loads connected to any point between V_+ and V_- . For light resistive loads ($> 100\text{k}\Omega$), the output voltage can swing to 100mV from the supply rail. With $2\text{k}\Omega$ resistive loads, the output is specified to swing to within 200mV of the supply rails while maintaining high open-loop gain (see the typical characteristic curve *Output Voltage Swing vs Output Current*).

CAPACITIVE LOAD AND STABILITY

The BUF04701 can drive up to 1000pF pure capacitive load. One method of improving capacitive load drive is to insert a 10 to 20Ω resistor in series with the output, as shown in Figure 5. This reduces ringing with large capacitive loads while maintaining DC accuracy.

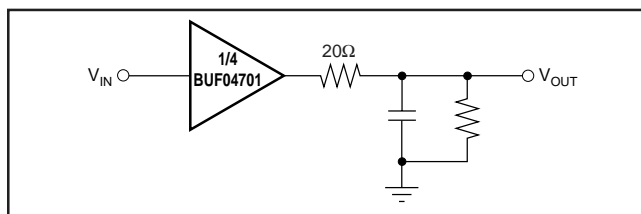

FIGURE 5. Improving Capacitive Load Drive.

APPLICATION CIRCUITS

REFERENCE BUFFER FOR LCD SOURCE DRIVERS

In modern high-resolution TFT-LCD displays, gamma correction must be performed to correct for nonlinearities in the glass transmission characteristics of the LCD panel. The typical LCD source driver for 64 bits of grayscale uses internal Digital-to-Analog Converters (DACs) to convert the 6-bit data into analog voltages applied to the LCD. These DACs typically require external voltage references for proper operation. Normally these external reference voltages are generated using a simple resistive ladder, like the one shown in Figure 6.

Typical laptop or desktop LCD panels require 6 to 8 of the source driver circuits in parallel to drive all columns of the panel. Although the resistive load of one internal string of a DAC is only around $10\text{k}\Omega$ to $16\text{k}\Omega$, 6 to 8 strings in parallel represent a very substantial load. The power supply used for the LCD source drivers for laptops is typically in the order of 10V . To maximize the dynamic range of the DAC, rail-to-rail

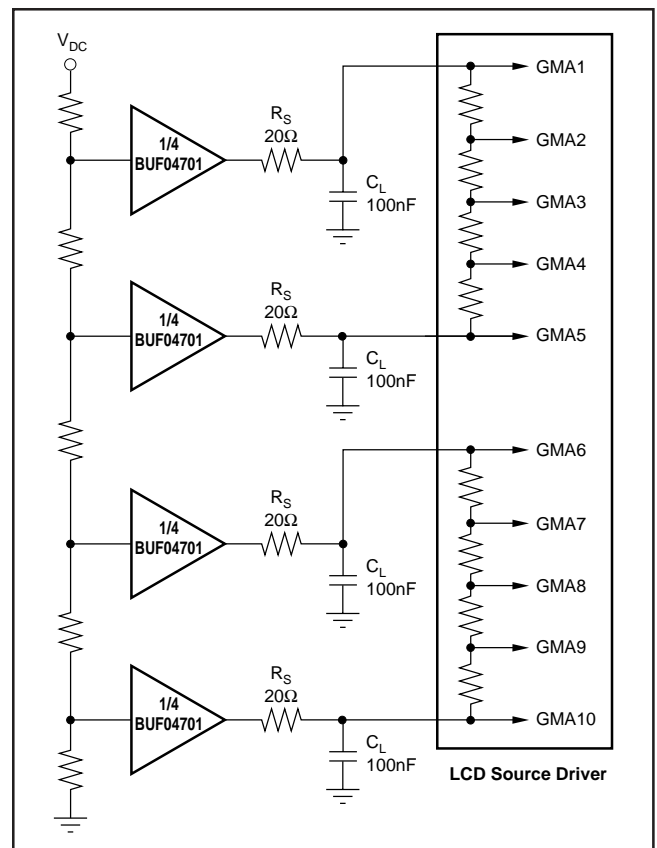

FIGURE 6. BUF04701 as LCD Display Buffer.

output performance is required for the upper and lower buffer. The ability of the BUF04701 to operate on 12V supplies, to drive heavy resistive loads (as low as $2\text{k}\Omega$), and to swing to within 200mV of the supply rails, makes it very well suited as a buffer for the reference voltage inputs of LCD source drivers.

During conversion of the DAC, internal switches create current glitches on the output of the reference buffer. The capacitor C_L (typically 100nF) functions as a charge reservoir that provides/absorbs most of the glitch energy. The series resistor R_S isolates the outputs of the BUF04701 from the heavy capacitive load and helps to improve settling time.

4-POLE LOW-PASS SALLEN-KEY FILTER

The high open-loop gain and wide bandwidth of the BUF04701 make it optimal for active filtering applications. Figure 7 shows the BUF04701 in a 4-pole Butterworth low-pass active filter configuration of 20kHz bandwidth.

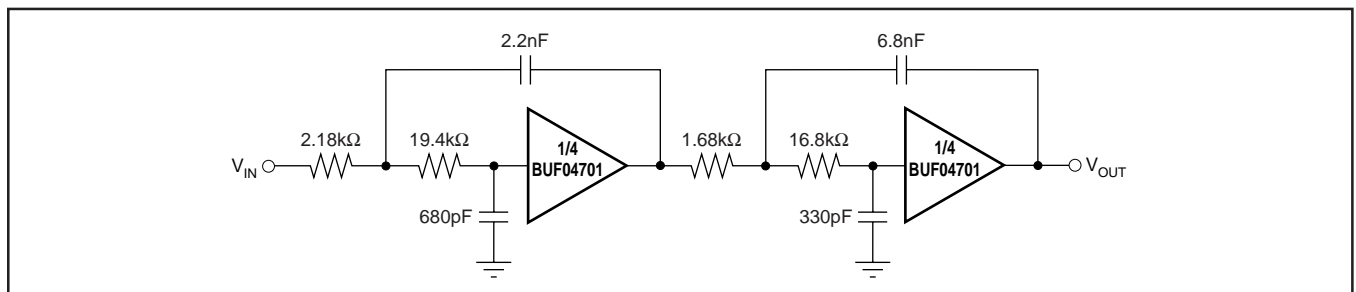

FIGURE 7. BUF04701 Configured as a 4-Pole Sallen-Key Butterworth Low-Pass Filter.

PACKAGING INFORMATION

Orderable Device	Status (1)	Package Type	Package Drawing	Pins	Package Qty	Eco Plan (2)	Lead finish/ Ball material (6)	MSL Peak Temp (3)	Op Temp (°C)	Device Marking (4/5)	Samples
BUF04701AIDGSR	NRND	VSSOP	DGS	10	2500	RoHS & Green	Call TI NIPDAUAG	Level-2-260C-1 YEAR	-40 to 125	B01	

(1) The marketing status values are defined as follows:

ACTIVE: Product device recommended for new designs.

LIFEBUY: TI has announced that the device will be discontinued, and a lifetime-buy period is in effect.

NRND: Not recommended for new designs. Device is in production to support existing customers, but TI does not recommend using this part in a new design.

PREVIEW: Device has been announced but is not in production. Samples may or may not be available.

OBSOLETE: TI has discontinued the production of the device.

(2) **RoHS:** TI defines "RoHS" to mean semiconductor products that are compliant with the current EU RoHS requirements for all 10 RoHS substances, including the requirement that RoHS substance do not exceed 0.1% by weight in homogeneous materials. Where designed to be soldered at high temperatures, "RoHS" products are suitable for use in specified lead-free processes. TI may reference these types of products as "Pb-Free".

RoHS Exempt: TI defines "RoHS Exempt" to mean products that contain lead but are compliant with EU RoHS pursuant to a specific EU RoHS exemption.

Green: TI defines "Green" to mean the content of Chlorine (Cl) and Bromine (Br) based flame retardants meet JS709B low halogen requirements of <=1000ppm threshold. Antimony trioxide based flame retardants must also meet the <=1000ppm threshold requirement.

(3) MSL, Peak Temp. - The Moisture Sensitivity Level rating according to the JEDEC industry standard classifications, and peak solder temperature.

(4) There may be additional marking, which relates to the logo, the lot trace code information, or the environmental category on the device.

(5) Multiple Device Markings will be inside parentheses. Only one Device Marking contained in parentheses and separated by a "-" will appear on a device. If a line is indented then it is a continuation of the previous line and the two combined represent the entire Device Marking for that device.

(6) Lead finish/Ball material - Orderable Devices may have multiple material finish options. Finish options are separated by a vertical ruled line. Lead finish/Ball material values may wrap to two lines if the finish value exceeds the maximum column width.

Important Information and Disclaimer:The information provided on this page represents TI's knowledge and belief as of the date that it is provided. TI bases its knowledge and belief on information provided by third parties, and makes no representation or warranty as to the accuracy of such information. Efforts are underway to better integrate information from third parties. TI has taken and continues to take reasonable steps to provide representative and accurate information but may not have conducted destructive testing or chemical analysis on incoming materials and chemicals. TI and TI suppliers consider certain information to be proprietary, and thus CAS numbers and other limited information may not be available for release.

In no event shall TI's liability arising out of such information exceed the total purchase price of the TI part(s) at issue in this document sold by TI to Customer on an annual basis.

DGS0010A



PACKAGE OUTLINE

VSSOP - 1.1 mm max height

SMALL OUTLINE PACKAGE

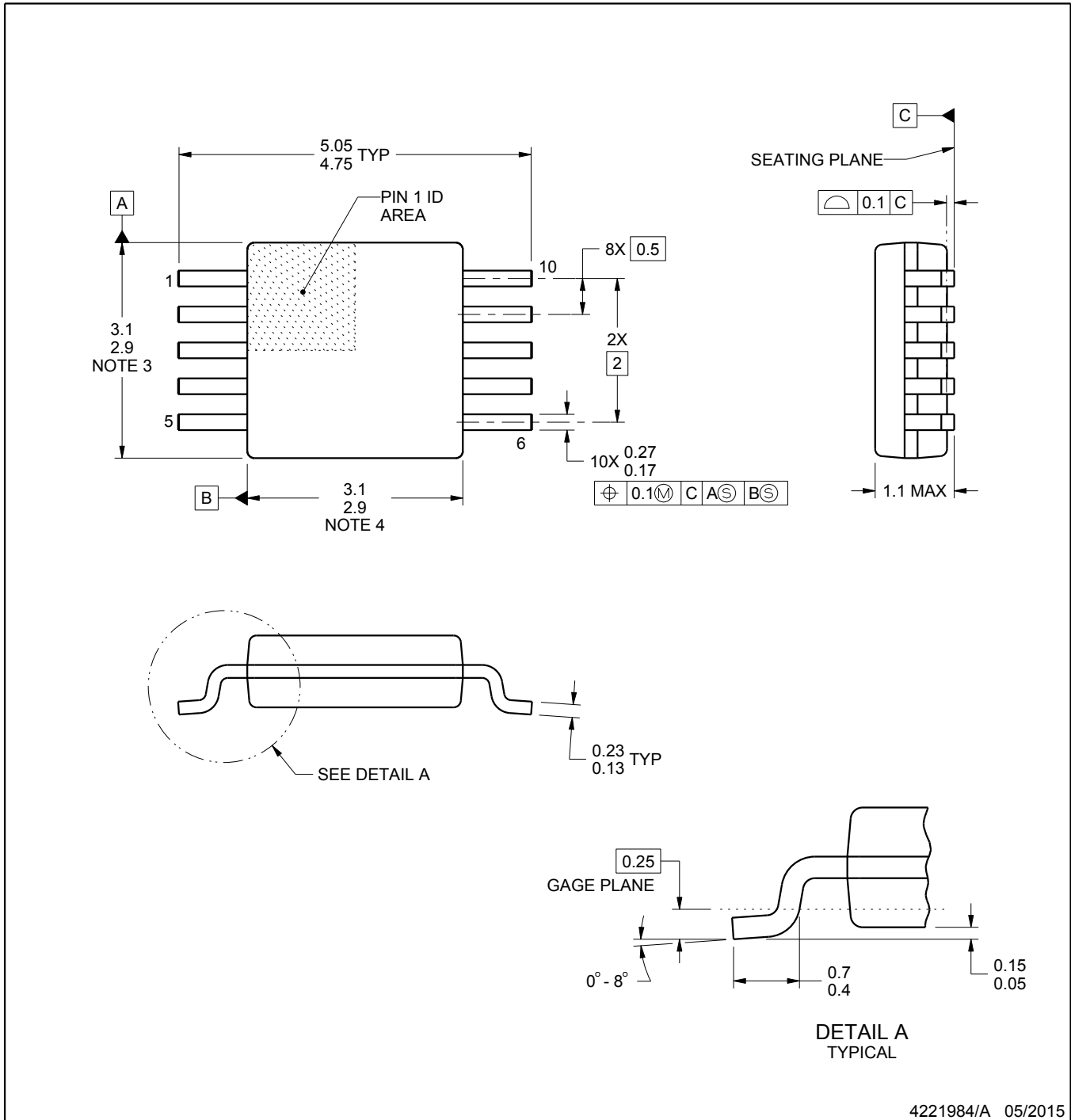

4221984/A 05/2015

NOTES:

1. All linear dimensions are in millimeters. Any dimensions in parenthesis are for reference only. Dimensioning and tolerancing per ASME Y14.5M.
2. This drawing is subject to change without notice.
3. This dimension does not include mold flash, protrusions, or gate burrs. Mold flash, protrusions, or gate burrs shall not exceed 0.15 mm per side.
4. This dimension does not include interlead flash. Interlead flash shall not exceed 0.25 mm per side.
5. Reference JEDEC registration MO-187, variation BA.

EXAMPLE BOARD LAYOUT

DGS0010A

VSSOP - 1.1 mm max height

SMALL OUTLINE PACKAGE

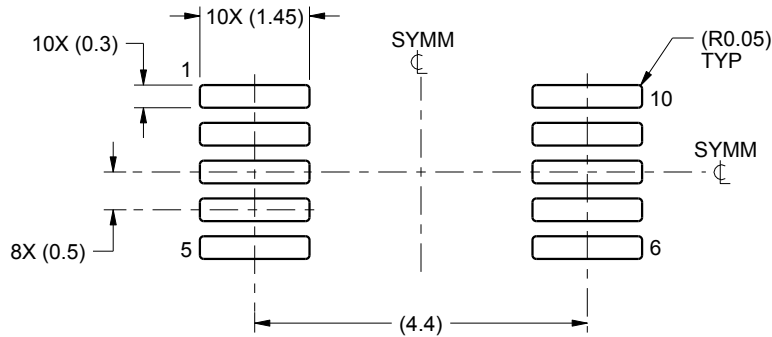

LAND PATTERN EXAMPLE
SCALE:10X

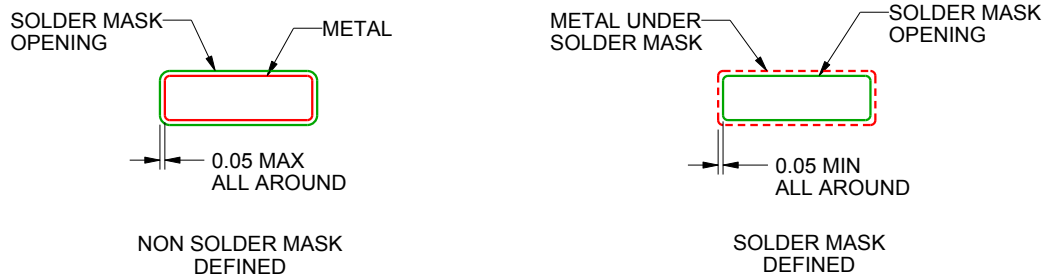

SOLDER MASK DETAILS
NOT TO SCALE

4221984/A 05/2015

NOTES: (continued)

- 6. Publication IPC-7351 may have alternate designs.
- 7. Solder mask tolerances between and around signal pads can vary based on board fabrication site.

EXAMPLE STENCIL DESIGN

DGS0010A

VSSOP - 1.1 mm max height

SMALL OUTLINE PACKAGE

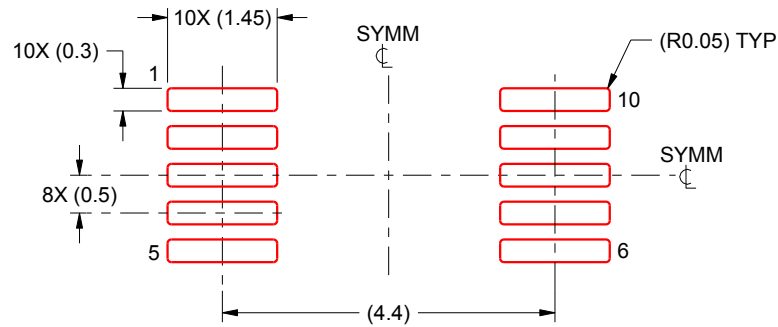

SOLDER PASTE EXAMPLE
BASED ON 0.125 mm THICK STENCIL
SCALE:10X

4221984/A 05/2015

NOTES: (continued)

8. Laser cutting apertures with trapezoidal walls and rounded corners may offer better paste release. IPC-7525 may have alternate design recommendations.
9. Board assembly site may have different recommendations for stencil design.

IMPORTANT NOTICE AND DISCLAIMER

TI PROVIDES TECHNICAL AND RELIABILITY DATA (INCLUDING DATA SHEETS), DESIGN RESOURCES (INCLUDING REFERENCE DESIGNS), APPLICATION OR OTHER DESIGN ADVICE, WEB TOOLS, SAFETY INFORMATION, AND OTHER RESOURCES "AS IS" AND WITH ALL FAULTS, AND DISCLAIMS ALL WARRANTIES, EXPRESS AND IMPLIED, INCLUDING WITHOUT LIMITATION ANY IMPLIED WARRANTIES OF MERCHANTABILITY, FITNESS FOR A PARTICULAR PURPOSE OR NON-INFRINGEMENT OF THIRD PARTY INTELLECTUAL PROPERTY RIGHTS.

These resources are intended for skilled developers designing with TI products. You are solely responsible for (1) selecting the appropriate TI products for your application, (2) designing, validating and testing your application, and (3) ensuring your application meets applicable standards, and any other safety, security, regulatory or other requirements.

These resources are subject to change without notice. TI grants you permission to use these resources only for development of an application that uses the TI products described in the resource. Other reproduction and display of these resources is prohibited. No license is granted to any other TI intellectual property right or to any third party intellectual property right. TI disclaims responsibility for, and you will fully indemnify TI and its representatives against, any claims, damages, costs, losses, and liabilities arising out of your use of these resources.

TI's products are provided subject to [TI's Terms of Sale](#) or other applicable terms available either on ti.com or provided in conjunction with such TI products. TI's provision of these resources does not expand or otherwise alter TI's applicable warranties or warranty disclaimers for TI products.

TI objects to and rejects any additional or different terms you may have proposed.

Mailing Address: Texas Instruments, Post Office Box 655303, Dallas, Texas 75265
Copyright © 2022, Texas Instruments Incorporated