

**Harvatek Surface Mount CHIP LEDs Data Sheet
B1101USD-20C000733U1930**

| | | | |
|---|-------------------------------------|------------|-----------------------|
| Official Product | HT Part No. B1101USD-20C000733U1930 | | |
| Tentative Product | ***** | ***** | ***** |
| Specifications are subject to changes for improvement without advance notice. Proprietary data, drawings, company confidential all rights reserved. | | 11/30/2021 | Version 1.1 Page 1/14 |

| | |
|---|-----------|
| DISCLAIMER | 3 |
| LIFE SUPPORT POLICY | 3 |
| PRODUCT SPECIFICATIONS | 4 |
| ATTENTION: ELECTROSTATIC DISCHARGE (ESD) PROTECTION | 4 |
| LABEL SPECIFICATIONS | 5 |
| SPECIFICATIONS RANGE | 6 |
| PRODUCT FEATURES | 7 |
| ELECTRO-OPTICAL CHARACTERISTICS | 7 |
| PACKAGE OUTLINE DIMENSION AND RECOMMENDED SOLDERING PATTERN FOR REFLOW | |
| SOLDERING | 7 |
| ABSOLUTE MAXIMUM RATINGS | 7 |
| CHARACTERISTICS OF B1101USD | 8 |
| PRECAUTION FOR USE | 9 |
| PACKAGING | 10 |
| TAPE DIMENSION | 10 |
| REEL DIMENSION | 11 |
| PACKING | 11 |
| DRY PACK | 12 |
| BAKING | 12 |
| PRECAUTIONS | 12 |
| REFLOW SOLDERING | 13 |
| REWORKING | 13 |
| CLEANING | 13 |
| CAUTIONS OF PICK AND PLACE | 14 |
| REVISE HISTORY | 14 |

| | | | |
|---|-------------------------------------|------------|-----------------------|
| Official Product | HT Part No. B1101USD-20C000733U1930 | | |
| Tentative Product | ***** | ***** | |
| Specifications are subject to changes for improvement without advance notice. Proprietary data, drawings, company confidential all rights reserved. | | 11/30/2021 | Version 1.1 Page 2/14 |

DISCLAIMER

HARVATEK reserves the right to make changes without further notice to any products herein to improve reliability, function or design. HARVATEK does not assume any liability arising out of the application or use of any product or circuit described herein; neither does it convey any license under its patent rights, nor the rights of others.

Life Support Policy

HARVATEK's products are not authorized for use as critical components in life support devices or systems without the express written approval of the President of HARVATEK or HARVATEK INTERNATIONAL. As used herein:

1. Life support devices or systems are devices or systems which, (a) are intended for surgical implant into the body, or (b) support or sustain life, and (c) whose failure to perform when properly used in accordance with instructions for use provided in the labeling, can be reasonably expected to result in a significant injury of the user.
2. A critical component in any component of a life support device or system whose failure to perform can be reasonably expected to cause the failure of the life support device or system, or to affect its safety or effectiveness.

| | | | |
|---|-------------------------------------|-------------|-----------|
| Official Product | HT Part No. B1101USD-20C000733U1930 | | |
| Tentative Product | ***** | ***** | ***** |
| Specifications are subject to changes for improvement without advance notice. Proprietary data, drawings, company confidential all rights reserved. | 11/30/2021 | Version 1.1 | Page 3/14 |

Product Specifications

| Item | Specification | Material | Quantity |
|------------------------|---|-----------------------------------|------------------|
| Luminous Intensity(Iv) | USD:45.0-180.0 mcd @20mA/ T _s = 25°C;Tolerance: ± 10% | | |
| Wavelength | USD:615.0-630.0 nm @20mA/ T _s = 25°C;Tolerance: ± 0.5nm | | |
| Vf | USD:1.6-2.4 V @20mA/ T _s = 25°C ;Tolerance: ± 0.05V | | |
| Ir | < 10 μA @ V _R = 5 V | | |
| Resin | Clear | Epoxy | |
| Carrier tape | EIA 481-1A specs | Conductive black tape | |
| Reel | EIA 481-1A specs | Conductive black | |
| Label | HT standard | Paper | |
| Packing bag | 250x230mm | Aluminum laminated bag/ no-zipper | One reel per bag |
| Carton | HT standard | Paper | Non-specified |

Others:

Each immediate box consists of 5 reels. The 5 reels may not necessarily have the same lot number or the same bin combinations of Iv, λ_D and Vf. Each reel has a label identifying its specification; the immediate box consists of a product label as well.

Note :This is shipped test conditions

※Remarks: This product should be operated in forward bias. If a reverse voltage is continuously applied to the product, such operation can cause migration resulting in LED damage.

ATTENTION: Electrostatic Discharge (ESD) protection



The symbol to the left denotes that ESD precaution is needed. ESD protection for GaP and AlGaAs based chips is necessary even though they are relatively safe in the presence of low static-electric discharge. Parts built with AlGaInP, GaN, or/and InGaN based chips are **STATIC SENSITIVE devices**. ESD precaution must be taken during design and assembly.

If manual work or processing is needed, please ensure the device is adequately protected from ESD during the process.

| | | | |
|---|-------------------------------------|-------------|-----------|
| Official Product | HT Part No. B1101USD-20C000733U1930 | | |
| Tentative Product | ***** | ***** | |
| Specifications are subject to changes for improvement without advance notice. Proprietary data, drawings, company confidential all rights reserved. | 11/30/2021 | Version 1.1 | Page 4/14 |

Label Specifications

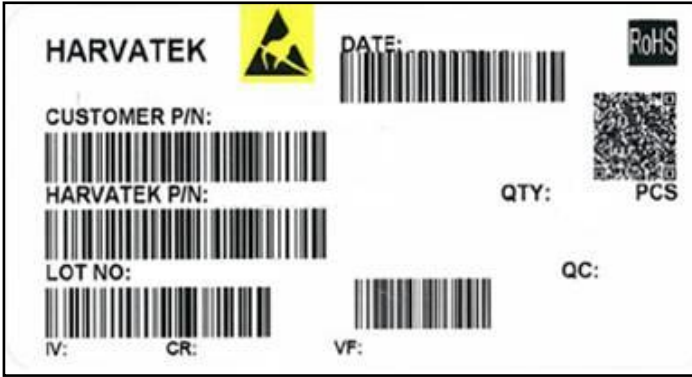

Harvatek P/N:

B 110 1 USD- 20C- 0007 33

| Product | Package | Dice Qty | Color | Current | Series Number | Taping |
|---------|-------------------------|----------|------------------|---------|---------------|--------------------------|
| B:PCB | 3.2(L)x1.0(W)x1.5(H) mm | 1:Single | Ultra Bright Red | 20mA | X001~XZZZ | 1.Taping style 2. Qty |

Lot No.:

| 1 | 2 | 3 | 4 | 5 | 6 | 7 | 8 | 9 | 10 |
|-----------------------|----------|---|---|--|--------------------|----------|--------------|----------|----------|
| E | 1 | A | 1 | A | 2 | 2 | L | 1 | 2 |
| Code 1 2 | | Code 3 | Code 4 | Code 5 | Code 6 | Code 7 | Code 8 | Code 9 | Code 10 |
| | | Mfg. Year | Mfg. Month | Mfg. Date | Consecutive number | | Special code | | |
| Internal Tracing Code | | 2020-L 2021-M 2022-P 2023-Q ... 2026-T 2027-V ... 2030-Y 2031-Z ... | 1:Jan. 2:Feb. ... A:Oct. B:Nov. C:Dec. | 1:A 2:B 3:C ... 26:Z 27:7 28:8 29:9 30:3 31:4 | 01~ZZ | | 000~ZZZ | | |

| | | | |
|---|-------------------------------------|------------|----------------------------|
| Official Product | HT Part No. B1101USD-20C000733U1930 | | |
| Tentative Product | ***** | ***** | ***** |
| Specifications are subject to changes for improvement without advance notice. Proprietary data, drawings, company confidential all rights reserved. | | 11/30/2021 | Version 1.1 Page 5/14 |

Specifications Range

■ Luminous Intensity (Iv) Bin:

| Color | Bin Code | Spec. Range |
|-------|----------|-----------------|
| USD | P | 45.00-71.50 mcd |
| | Q | 71.50-112.5 mcd |
| | R | 112.5-180.0 mcd |

Note: It maintains a tolerance of $\pm 10\%$ on Luminous Intensity

■ Wavelength Bin:

| Color | Bin Code | Spec. Range |
|-------|----------|----------------|
| USD | AC | 615.0-630.0 nm |

Note: It maintains a tolerance of $\pm 0.5\text{nm}$ on Wavelength Bin

■ Forward Voltage (Vf) Bin:

| Color | Bin Code | Spec. Range |
|-------|----------|-------------|
| USD | E18 | 1.6-2.4 V |

Note: It maintains a tolerance of $\pm 0.05\text{V}$ on forward voltage measurements

| | | | |
|---|-------------------------------------|------------|-----------------------|
| Official Product | HT Part No. B1101USD-20C000733U1930 | | |
| Tentative Product | ***** | ***** | ***** |
| Specifications are subject to changes for improvement without advance notice. Proprietary data, drawings, company confidential all rights reserved. | | 11/30/2021 | Version 1.1 Page 6/14 |

Product Features

Electro-Optical Characteristics

(T_{Soldering}, 25 °C)

| Series | Emitting Color | Material | V _F (V) | | Wavelength λ(nm) | | | I _V (mcd) | Viewing Angle 2θ _{1/2} |
|-------------|----------------|----------|--------------------|-----|------------------|----------------|----|----------------------|---------------------------------|
| | | | typ | max | λ _D | λ _P | Δλ | Typical | |
| B1101USD-20 | USD | AlGaInP | 2.0 | 2.4 | 624 | 632 | 20 | 71.5 | X=140 Y=116 |

Package Outline Dimension and Recommended Soldering Pattern for Reflow Soldering

(Unit:mm Tolerance: +/-0.1)

| Outline Dim. | Suggest Soldering Pattern |
|--|---------------------------|
| | |
| Soldering terminals may shift in the x, y direction. | |

Absolute Maximum Ratings

(T_{Soldering} 25 °C)

| Series | P _D (mW) | I _F (mA) | I _{FP} (mA)* | T _{OP} (°C) | T _{ST} (°C) |
|--------|---------------------|---------------------|-----------------------|-----------------------|----------------------|
| Color | Power Dissipation | Forward Current | Pulse Forward Current | Operating Temperature | Storage Temperature |
| USD | 48 | 20 | 100 | -40~+85 | -40~+100 |

*Condition for I_{FP} is pulse of 1/10 duty and 0.1msec width

| | | | |
|---|-------------------------------------|------------|-----------------------|
| Official Product | HT Part No. B1101USD-20C000733U1930 | | |
| Tentative Product | ***** | ***** | ***** |
| Specifications are subject to changes for improvement without advance notice. Proprietary data, drawings, company confidential all rights reserved. | | 11/30/2021 | Version 1.1 Page 7/14 |

Characteristics of B1101USD

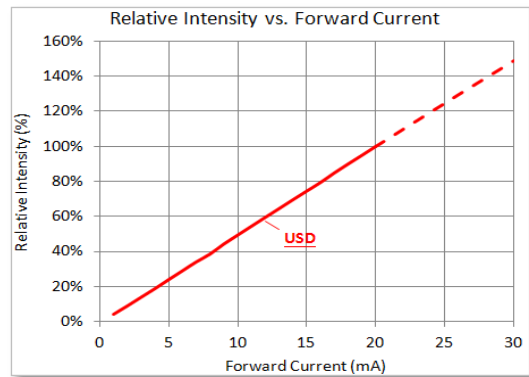
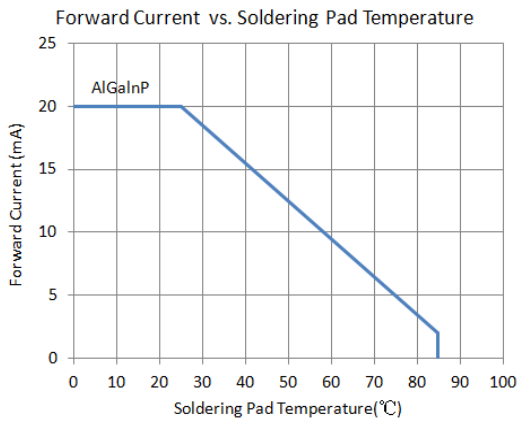
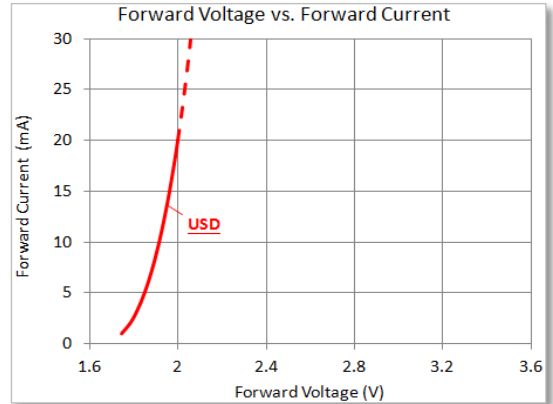
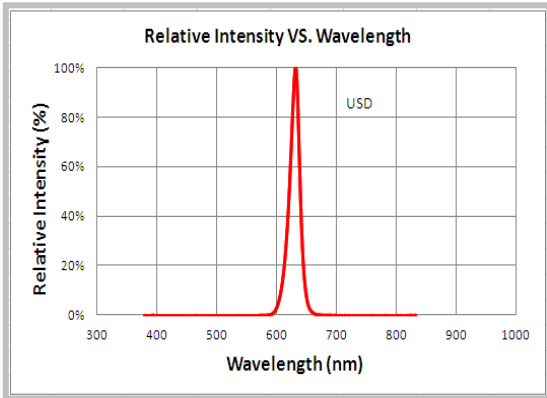

Directive Characteristics

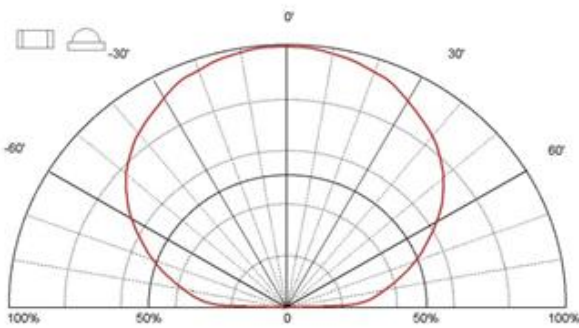

Directive Characteristics

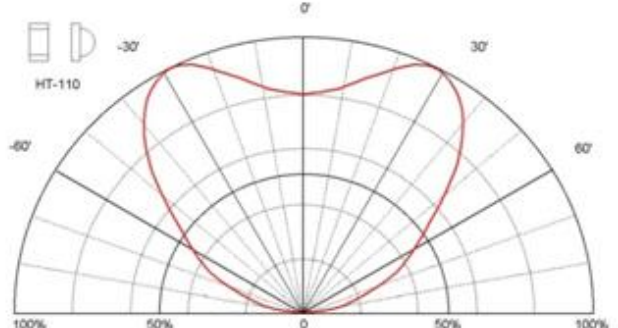

| | | | |
|---|-------------------------------------|-------------|-----------|
| Official Product | HT Part No. B1101USD-20C000733U1930 | | |
| Tentative Product | ***** | ***** | ***** |
| Specifications are subject to changes for improvement without advance notice. Proprietary data, drawings, company confidential all rights reserved. | 11/30/2021 | Version 1.1 | Page 8/14 |

Precaution for Use

1. The chips should not be used directly in any type of fluid such as water, oil, organic solvent, etc.
2. When the LEDs are illuminating, the maximum ambient temperature should be first considered before operation.
3. LEDs must be stored in a clean environment. A sealed container with a nitrogen atmosphere is necessary if the storage period is over 3 months after shipping.
4. The LEDs must be used within 4 weeks after unpacked. Unused products must be repacked in an anti-electrostatic package, folded to close any opening and then stored in a dry and cool space.
5. The appearance and specifications of the products may be modified for improvement without further notice.
6. The LEDs are sensitive to the static electricity and surge. It is strongly recommended to use a grounded wrist band and anti-electrostatic glove when handling the LEDs. If a voltage over the absolute maximum rating is applied to LEDs, it will damage LEDs. Damaged LEDs will show some abnormal characteristics such as remarkable increase of leak current, lower turn-on voltage and getting unlit at low current.

| | | | |
|---|-------------------------------------|------------|-----------------------|
| Official Product | HT Part No. B1101USD-20C000733U1930 | | |
| Tentative Product | ***** | ***** | ***** |
| Specifications are subject to changes for improvement without advance notice. Proprietary data, drawings, company confidential all rights reserved. | | 11/30/2021 | Version 1.1 Page 9/14 |

Packaging Tape Dimension

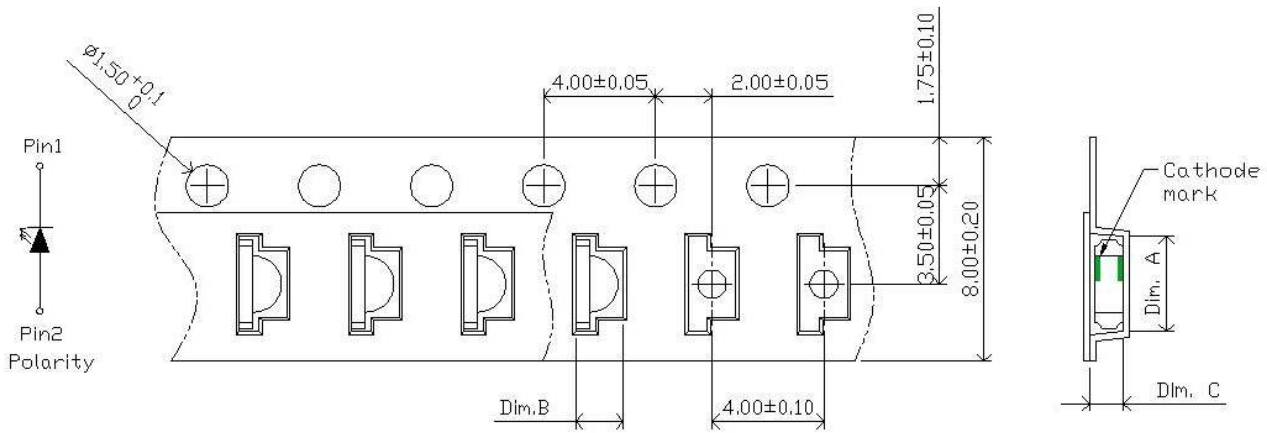

| Dim. A | Dim. B | Dim. C | Qty/Reel |
|-----------|-----------|-----------|----------|
| 3.40±0.10 | 1.70±0.10 | 1.20±0.10 | 3K |

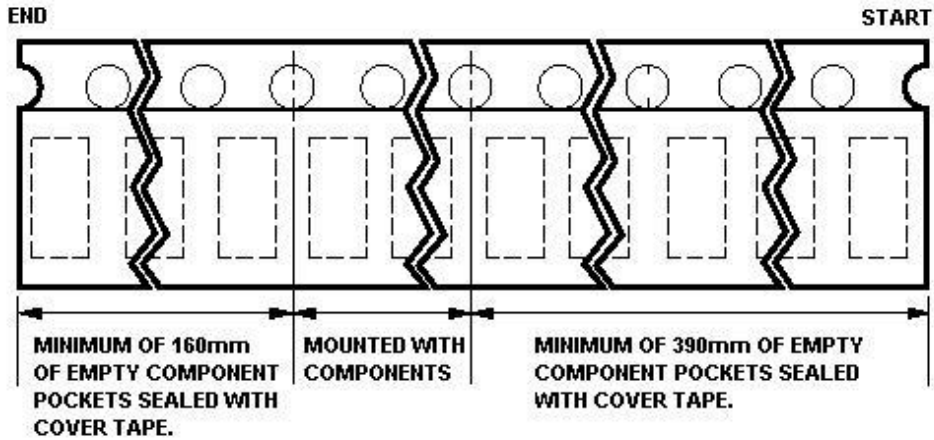

| | | | |
|---|-------------------------------------|------------|------------------------|
| Official Product | HT Part No. B1101USD-20C000733U1930 | | |
| Tentative Product | ***** | ***** | ***** |
| Specifications are subject to changes for improvement without advance notice. Proprietary data, drawings, company confidential all rights reserved. | | 11/30/2021 | Version 1.1 Page 10/14 |

Reel Dimension

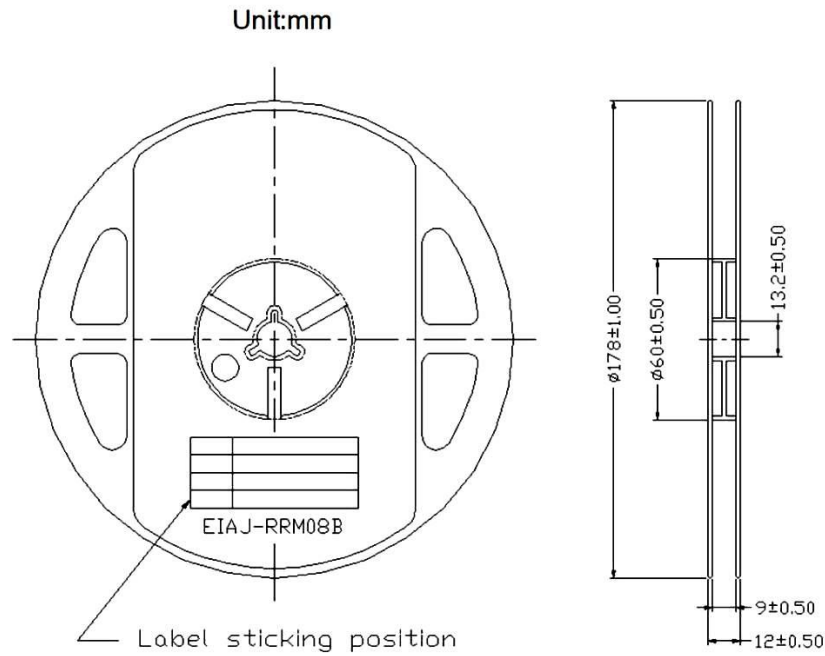

Packing

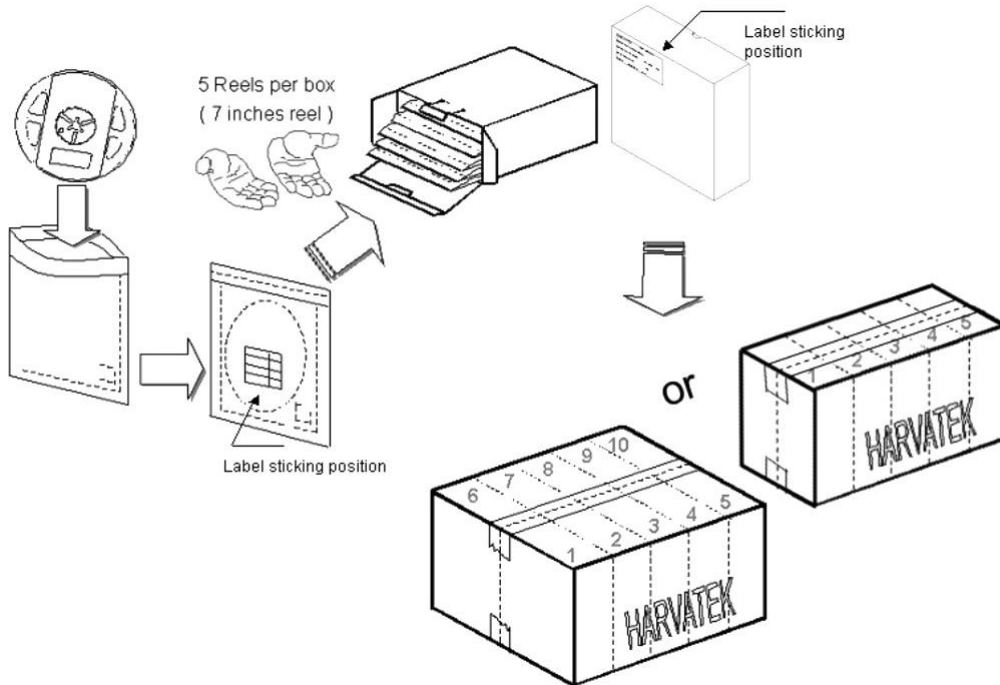

5 or 10 boxes per carton is available depending on shipment quantity.

| | | | |
|---|-------------------------------------|------------|------------------------|
| Official Product | HT Part No. B1101USD-20C000733U1930 | | |
| Tentative Product | ***** | ***** | ***** |
| Specifications are subject to changes for improvement without advance notice. Proprietary data, drawings, company confidential all rights reserved. | | 11/30/2021 | Version 1.1 Page 11/14 |

Dry Pack

All SMD optical devices are **MOISTURE SENSITIVE**. Avoid exposure to moisture at all times during transportation or storage. Every reel is packaged in a moisture protected anti-static bag. Each bag is properly sealed prior to shipment.

A humidity indicator will be included in the moisture protected anti-static bag prior to shipment.

The packaging sequence is as follows:



Baking

Baking before soldering is recommended when the package has been unsealed for 4 weeks.

The conditions are as followings:

1. 60±3°C ×(12~24hrs)and<5%RH, taped reel type.
2. 100±3°C ×(45min~1hr), bulk type.
3. 130±3°C ×(15min~30min), bulk type.

Precautions

1. Avoid exposure to moisture at all times during transportation or storage.
2. Anti-Static precaution must be taken when handling GaN, InGaN, and AlGaInP products.
3. It is suggested to connect the unit with a current limiting resistor of the proper size. Avoid applying a reverse voltage beyond the specified limit.
4. Avoid operation beyond the limits as specified by the absolute maximum ratings.
5. Avoid direct contact with the surface through which the LED emits light.
6. If possible, assemble the unit in a clean room or dust-free environment.

| | | | |
|---|-------------------------------------|------------|------------------------|
| Official Product | HT Part No. B1101USD-20C000733U1930 | | |
| Tentative Product | ***** | ***** | ***** |
| Specifications are subject to changes for improvement without advance notice. Proprietary data, drawings, company confidential all rights reserved. | | 11/30/2021 | Version 1.1 Page 12/14 |

Reflow Soldering

Recommend soldering paste specifications:

1. Operating temp.: Above 217°C ,60~150 sec
2. Peak temp.:260 °C Max.,10sec Max.
3. Reflow soldering should not be done more than two times.
4. Never attempt next process until the component is cooled down to room temperature after reflow.
5. The recommended reflow soldering profile (measured on the surface of the LED terminal) is as following:

Lead-free Solder Profile

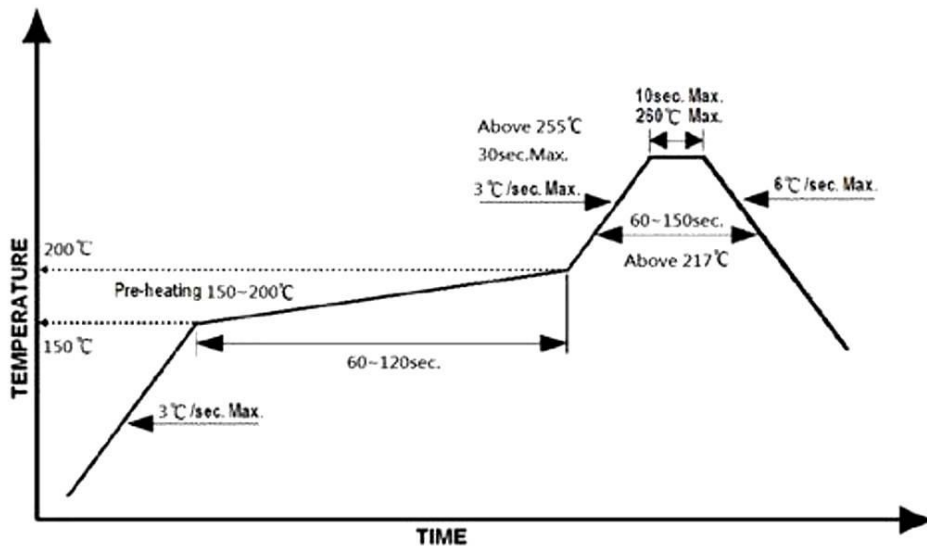

Reworking

- Rework should be completed within 5 seconds under 260°C.
- The iron tip must not come in contact with the copper foil.
- Twin-head type is preferred.

Cleaning

Following are cleaning procedures after soldering:

- An alcohol-based solvent such as isopropyl alcohol (IPA) is recommended.
- Temperature x Time should be 50°C x 30sec. or <30°C x 3min
- Ultrasonic cleaning: < 15W/ bath; bath volume ≤ 1liter
- Curing: 100°C max, <3min

| | | | |
|---|-------------------------------------|------------|------------------------|
| Official Product | HT Part No. B1101USD-20C000733U1930 | | |
| Tentative Product | ***** | ***** | ***** |
| Specifications are subject to changes for improvement without advance notice. Proprietary data, drawings, company confidential all rights reserved. | | 11/30/2021 | Version 1.1 Page 13/14 |

