

VCA8500BOARD

The Texas Instruments VCA8500BOARD evaluation module makes it easy to evaluate the performance of the TI VCA8500 variable gain amplifier. This user's guide provides a description of the evaluation module and its operation, schematic diagram, bill of materials, and the printed-circuit board layout.

If going from a Rev B BOARD to a Rev C BOARD, /CS has been changed to RESET.

Contents

1	Description	2
2	Initial Configuration	2
	2.1 Power Supply	2
3	Signals	2
	3.1 Input Signals	2
	3.2 Output Signals	2
	3.3 TGC Outputs	3
	3.4 CW Outputs	3
4	Microcontroller	3
5	Modes of Operation	3
	5.1 Default-Power-Up Mode	4
	5.2 PC Control Mode	4
	5.3 Direct Control Mode	4
6	VCA8500BOARD Full-Access Software	4
	6.1 Loading the Software	4
	6.2 Initial Start-up Screen	4
	6.3 Other Program Functions	8
7	Printed-Circuit Board Layout, Bill of Materials, and Schematic	8
	7.1 Printed-Circuit Board Layout	8
	7.2 Bill of Materials	12
	7.3 Schematic	13

List of Figures

1	CW Output Circuit.....	3
2	Initial Start-up Screen	5
3	Main Program Window	6
4	CW Options Selection	7
5	Silkscreen — Top Layer	8
6	Ground	9
7	Power Plane 1	9
8	Power Plane 2	10
9	Ground	10
10	Silkscreen — Bottom Layer	11
11	Schematic Pg.1	14
12	Schematic Pg.2	15

List of Tables

1	Bill of Materials.....	12
---	------------------------	----

1 Description

The Texas Instruments VCA8500BOARD evaluation module makes it easy to evaluate the performance of the VCA8500 variable gain amplifier. The evaluation module operates in three modes: Default Power Up, PC Control, and Direct Control. Default-Power-Up mode does not require any external clocking or data input to enable the operation of the VCA8500. The functionality in Default-Power-Up mode is limited to factory-programmed modes. PC-Control mode uses the included software to operate all of the functions of the VCA8500. The software was written on Windows™ XP and its operation has been verified with Windows™ XP. Direct-Control mode uses external control and data signals to control the functions of the VCA8500.

The VCA8500BOARD has the following features:

- Easy testing of the VCA8500
- Single-ended input
- Three modes of operation:
 - Default Power Up
 - PC Control
 - Direct Control

2 Initial Configuration

2.1 Power Supply

The VCA8500BOARD has provisions for six separate power supplies:

- +5 V: Positive VCA Supply
 - This positive 5 V supplies the CW and VCA circuits. (P2)
- +3.3 V: Positive VCA Supply
 - This positive 3.3 V supplies the LNA, Digital circuit and VCA Outputs . Ensure that all three pads of W1 solder jumper are shorted. (P2)
- +5 V/-5 V: Supplies for all other circuitry
 - These supply all other +5 V/-5 V requirements onboard. (P4)
- +15 V/-15 V: Supplies for CW Amplifiers
 - These supplies are optional for the CW amplifiers only. The user does not need them connected unless using CW Mode. To drive these amplifiers with +15 V/-15 V, W2 and W3 solder jumpers should be open. (P3)

3 Signals

3.1 Input Signals

The input signals are applied to SMA connectors J1 to J8. The input impedance of the VCA is 8 kΩ. The inputs are ac-coupled into the LNA of the VCA8500 through 1-μF capacitors and do not attenuate the input signal.

3.2 Output Signals

The outputs of the evaluation module are located at SMA connectors J21 through J28 for the TGC outputs, and J10 to J19 for the CW outputs. The outputs from the VCA8500 are buffered with operational amplifiers.

3.3 TGC Outputs

The differential TGC outputs are buffered by operational amplifiers (OPA842) in a differential configuration with a differential gain of 1. When testing the VCA8500BOARD, outputs J21 through J28 (TGC outputs) must be terminated into 50-Ω loads such as those of a spectrum analyzer. This termination results in the proper matching for the output amplifiers, and no loss has to be taken into account.

3.4 CW Outputs

Figure 1 shows the CW output circuit. This circuit is duplicated for each CW output.

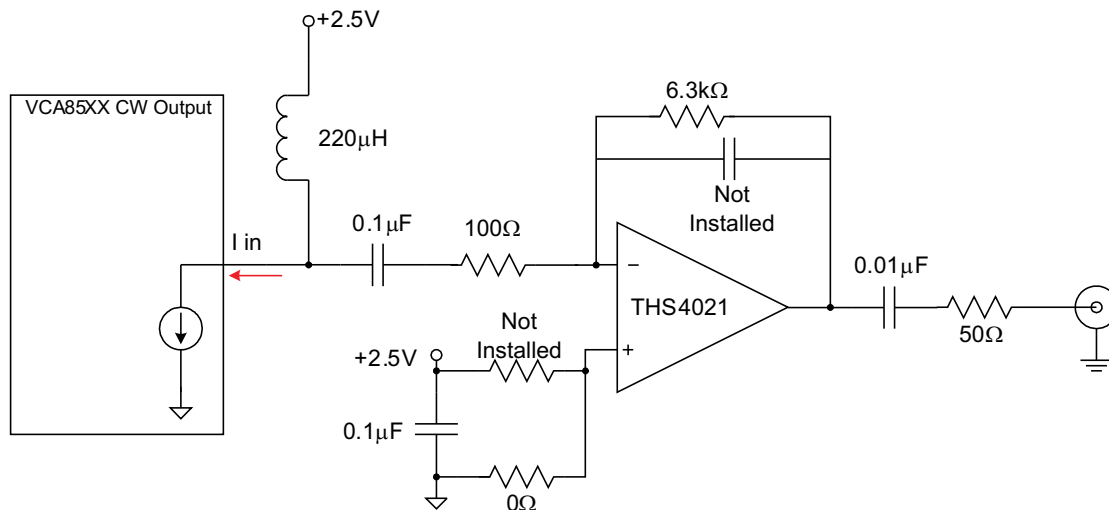

Figure 1. CW Output Circuit

The CW outputs are current outputs and require a current-to-voltage conversion in order to view the outputs with an oscilloscope or spectrum analyzer. The THS4021 operational amplifier is used as the current-to-voltage converter.

When using the VCA8500, the CW outputs need a compliance voltage of +2.5 V. The circuit in Figure 1 shows how the compliance voltage is applied to the VCA8500 device through a 220-μH inductor. The CW output circuit allows the noise of the CW path to be measured. This configuration is the reason for the large feedback resistor in the output amplifier circuit. Before summing more than two CW channels, ensure that the output amplifier does not exceed its maximum output capability. To increase the output capability of the THS4021 ensure that W2 and W3 are open and supply ±15 V to P3.

4 Microcontroller

The VCA8500BOARD contains a microcontroller to access internal functions. The microcontroller provides the evaluation module the ability to be controlled by software running on a PC. The microcontroller is run from its own internal oscillator set to 12 MHz. The only external clock signals are those used to communicate to the VCA8500 via the serial data clock line, and the embedded clock signal in the RS-232 communications circuit. The RS-232 clock operates only when data is being sent from the personal computer (PC) to the microcontroller. The serial communication from the PC to the microcontroller is set to 19200 kbps (baud rate). This baud rate is set internally on the microcontroller and is configured automatically in the PC software.

5 Modes of Operation

The three modes of operation for the VCA8500BOARD are Default Power Up, PC Control, and Direct-Control.

5.1 **Default-Power-Up Mode**

If no external source or PC control is available, the VCA8500 powers up in a default mode, which sets the VCA8500 to TGC mode with these settings, PGA Gain 20 dB, Clamp Level Disabled, and Filter Bandwidth 15 MHz.

5.2 **PC Control Mode**

This mode requires P10 to be shorted using surface-mount jumpers. This allows the VCA to interface with the microcontroller. Switch S1 is not installed, and the settings are hard-wired to PC-Control mode. The VCA8500 is controlled by the software running on a PC. At this point, the serial cable included with the VCA8500BOARD must be connected to the PC serial port. The program called VCA8500EVM then sets the proper baud rate for communication with the VCA8500BOARD. By using a PC to control the VCA8500, the entire device functionality is available for testing. The software provides the ability to select any of the clamp ranges, filter bandwidth, PGA gains settings, direct an input to any CW output, or power down the chip completely.

5.3 **Direct Control Mode**

Remove solder jumpers from P10, and connect the external source to DIN, CLK, DOUT, and \overline{CS} . These are SMA connectors J30, J31, J32, and J33, respectively. This allows for direct control of the VCA8500 with an external control source such as a digital word generator.

6 **VCA8500BOARD Full-Access Software**

The TI website includes full-access installation software, data sheet, and EVM schematic

6.1 **Loading the Software**

Download the zip file from the TI website at <http://www.ti.com/product/vca8500>. . Select the folder called *Installation Software*, and double-click on Setup.exe. The installation wizard guides you through the rest of the installation process.

6.2 **Initial Start-up Screen**

[Figure 2](#) shows the initial start-up screen.

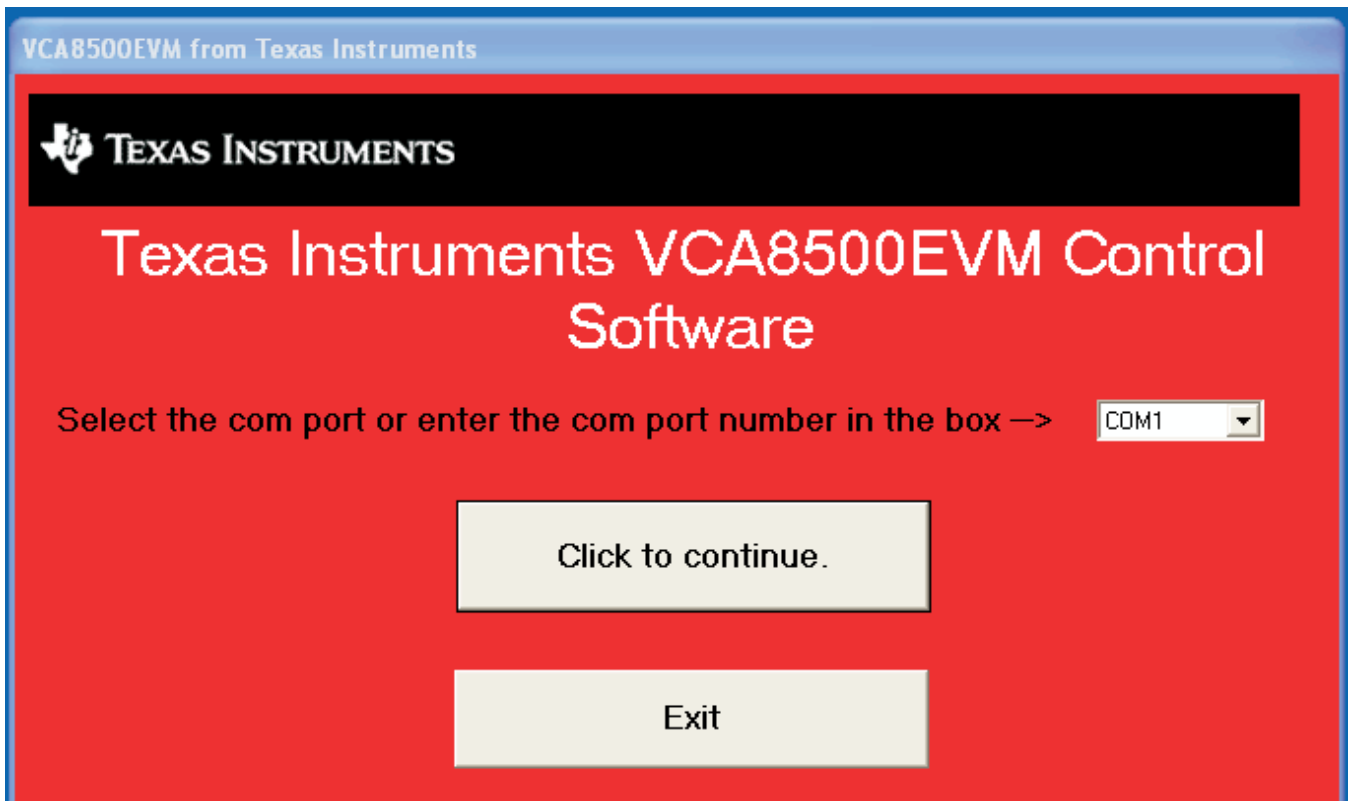

Figure 2. Initial Start-up Screen

If COM1 is used, then click the *Click to continue* box. Otherwise, select the correct COM port from the list that the program provided prior to selecting the continue box.

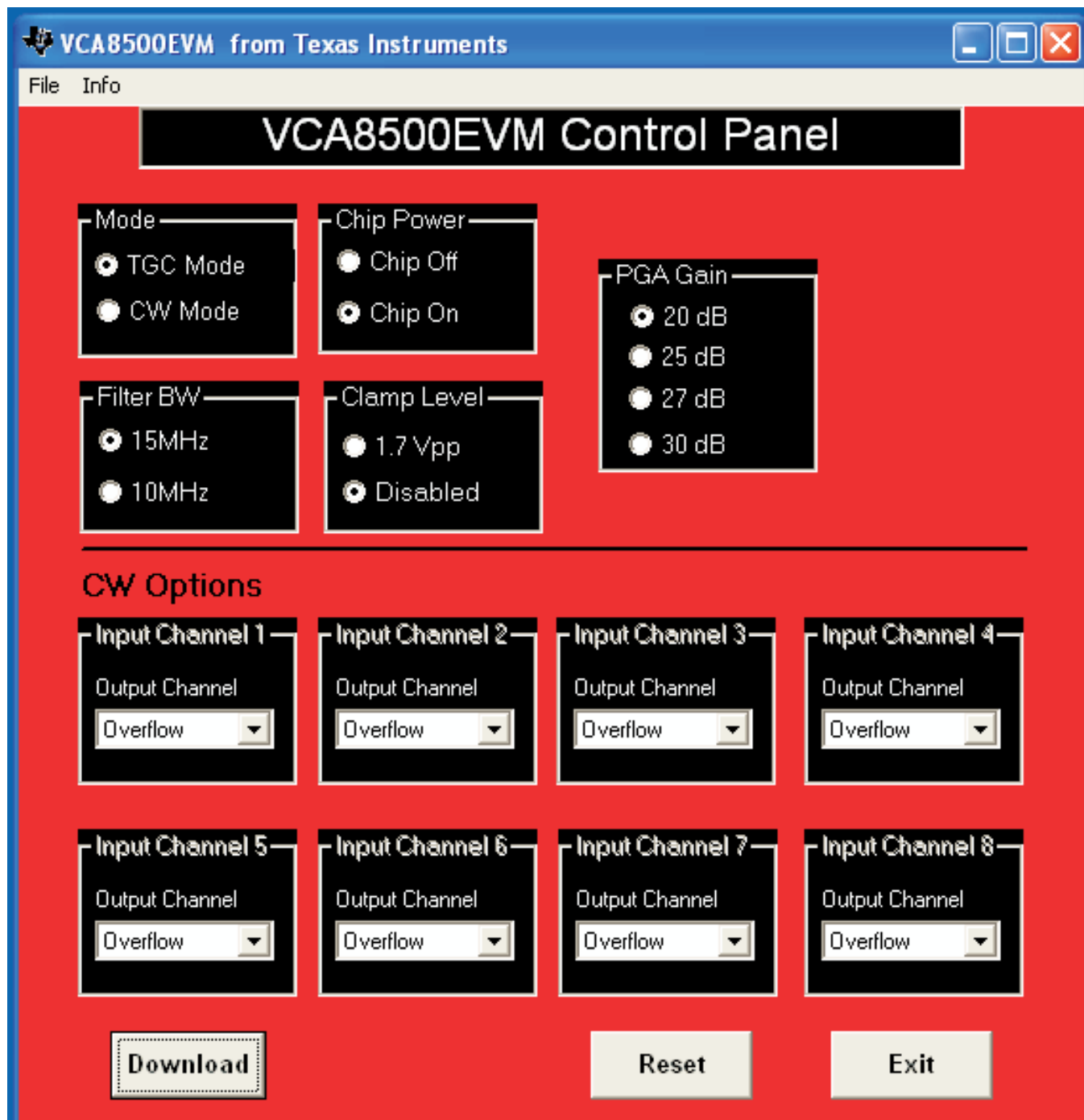

Figure 3. Main Program Window

The main program window allows the user to choose the mode of operation. [Figure 3](#) displays the default program settings. In order to activate these settings, click *Download*. When *Reset* is selected, all options are set to these same default settings, but the user must press *Download* again in order for the changes to take effect. The Chip Power option only affects the VCA8500 and no other IC on the evaluation board. If TGC mode is selected, the *Clamp Level*, *Filter Bandwidth*, and *PGA Gain* options become available. If CW mode is selected, the CW options become available and the other functions are disabled.

When the selections have been made, click *Download* to send the data to the VCA8500 in this case.

When the VCA8500BOARD is controlled by the software, any input to the VCA8500 can be routed to any of the CW outputs via the CW Options selections. Each input channel is listed with a pull-down menu to select any of the ten available outputs (CW0 to CW9) or the Overflow option, which effectively disables the channel. Figure 4 shows this process.

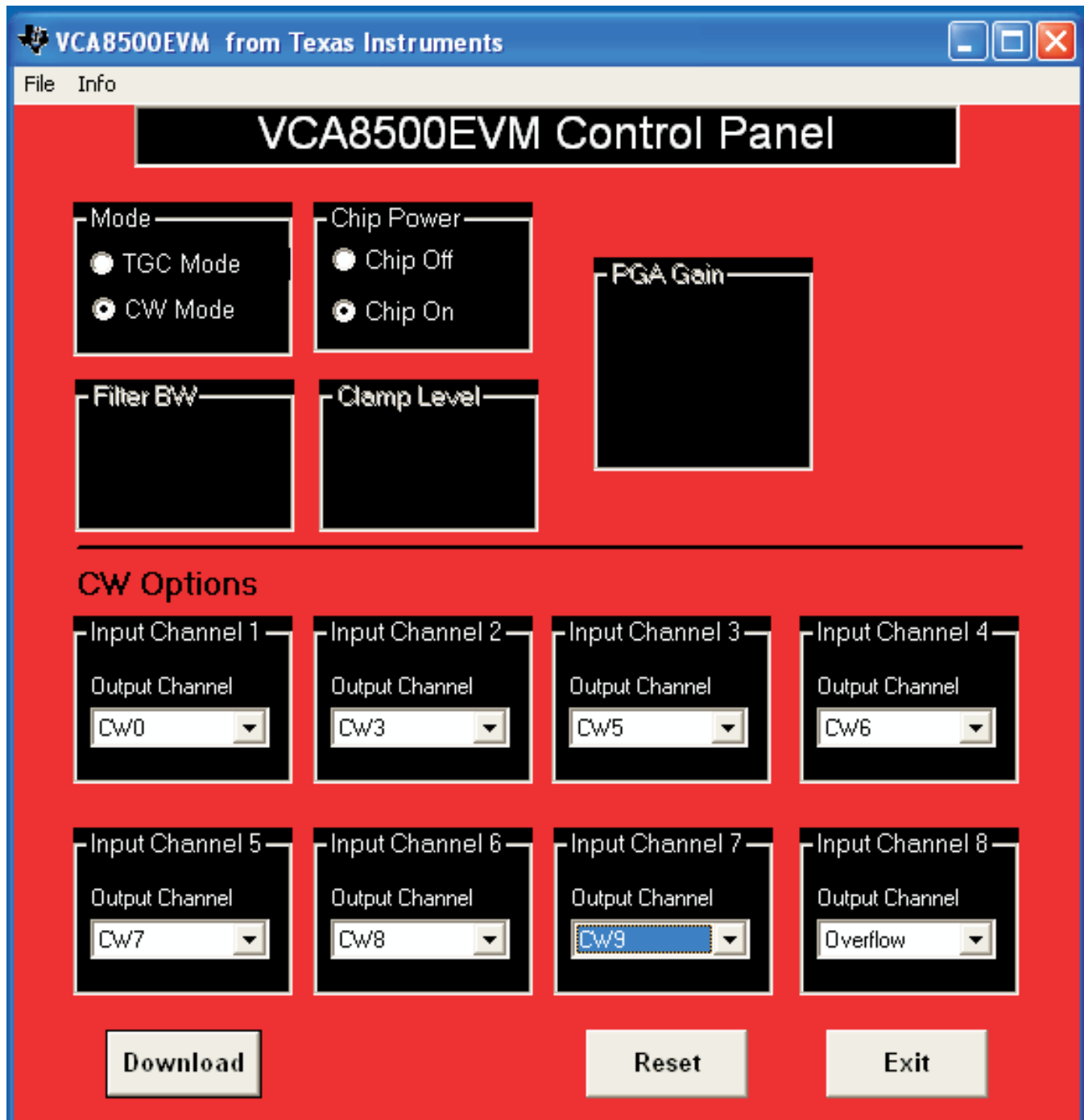

Figure 4. CW Options Selection

Once all the selections have been made, click Download to send the data to the VCA8500. It is possible, because of the flexible nature of the software, to direct all inputs to one output. This is permissible and can be supported as long as the output amplifiers in the CW current-to-voltage converters are driven with a $\pm 15\text{-V}$ supply (P3); also, W2 and W3 need to be open. The maximum output current from one input channel is 3 mA.

The EVM software is available on the Texas Instruments Web site, ti.com, by looking in the VCA8500 product folder in the *Tools and Software* section.

6.3 Other Program Functions

Selecting the *Exit* command button exits the program. The *Help* pull-down menu contains information on the program and support information.

7 Printed-Circuit Board Layout, Bill of Materials, and Schematic

This section provides the printed-circuit board layout, the bill of materials, and the schematics.

7.1 Printed-Circuit Board Layout

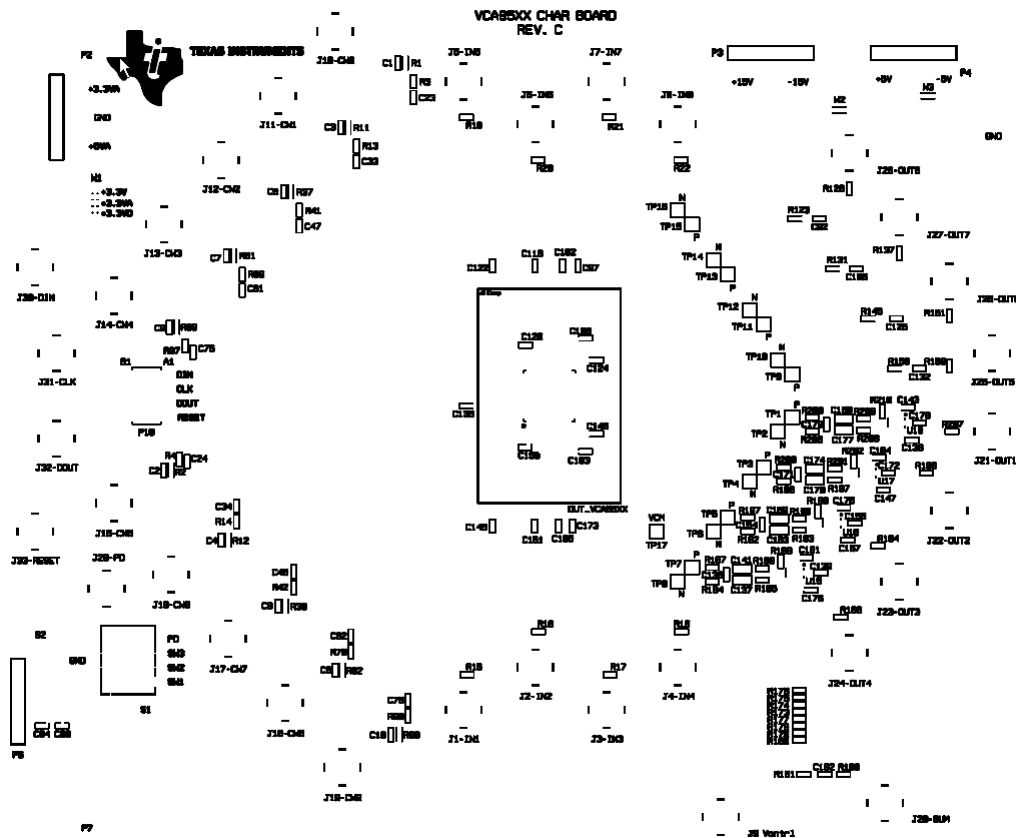

Figure 5. Silkscreen — Top Layer

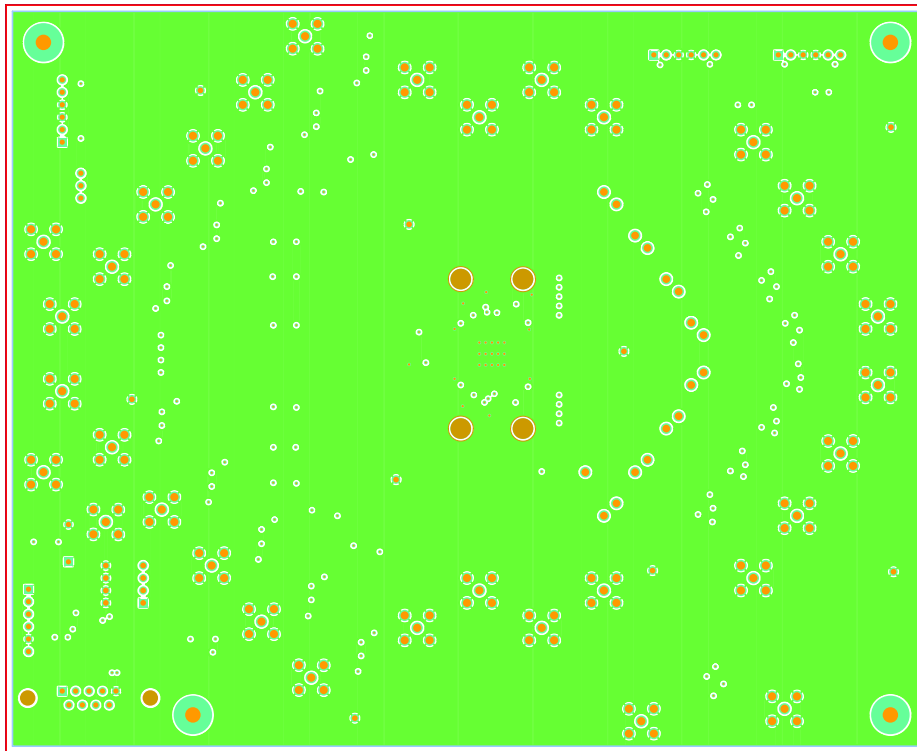

Figure 6. Ground

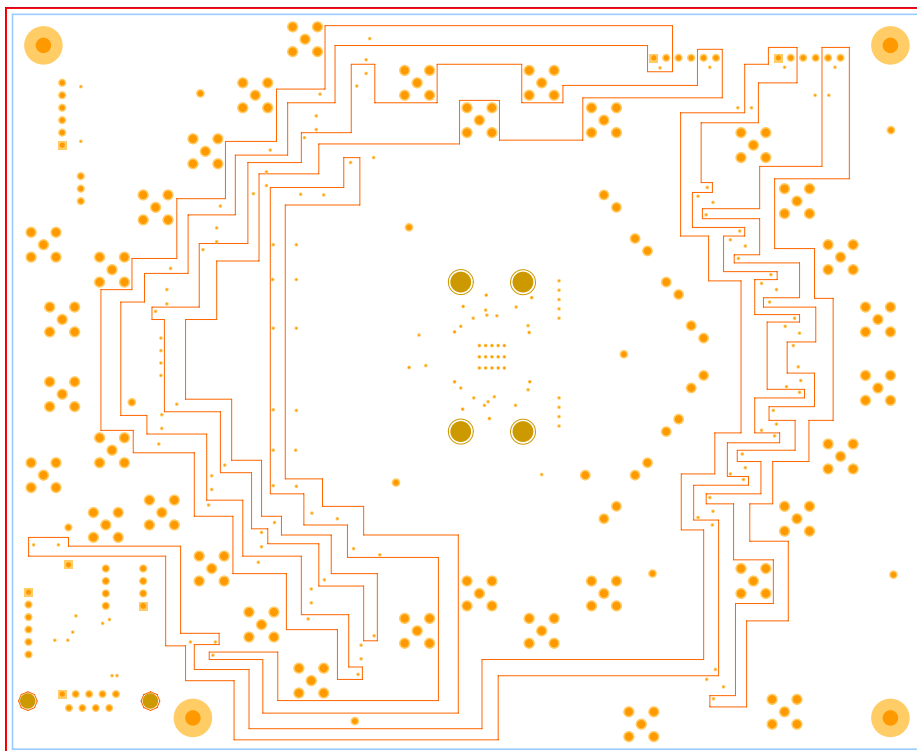

Figure 7. Power Plane 1

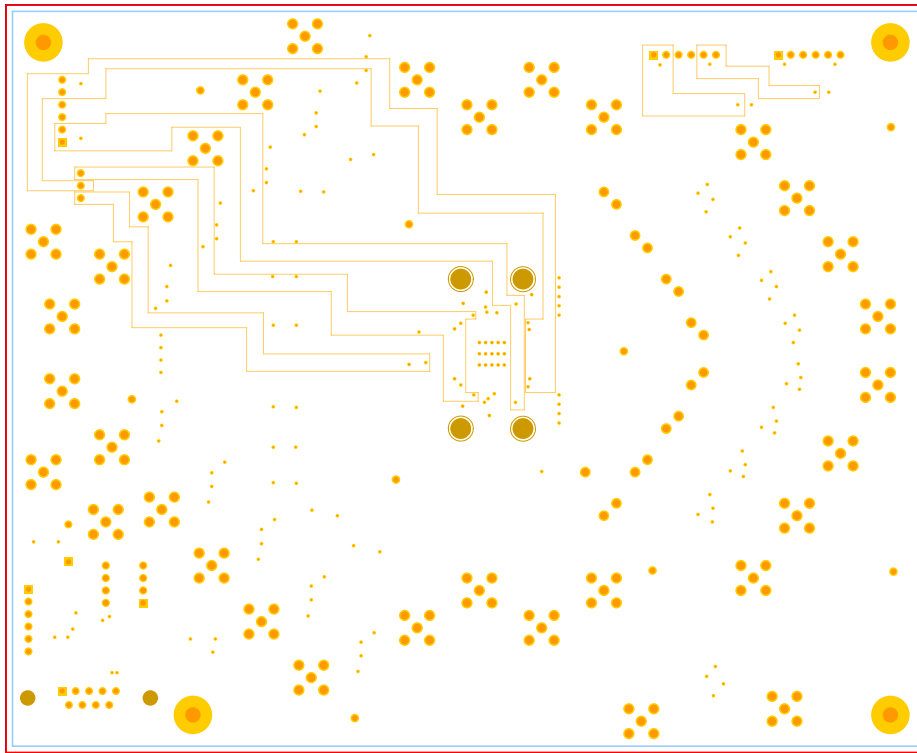

Figure 8. Power Plane 2



Figure 9. Ground

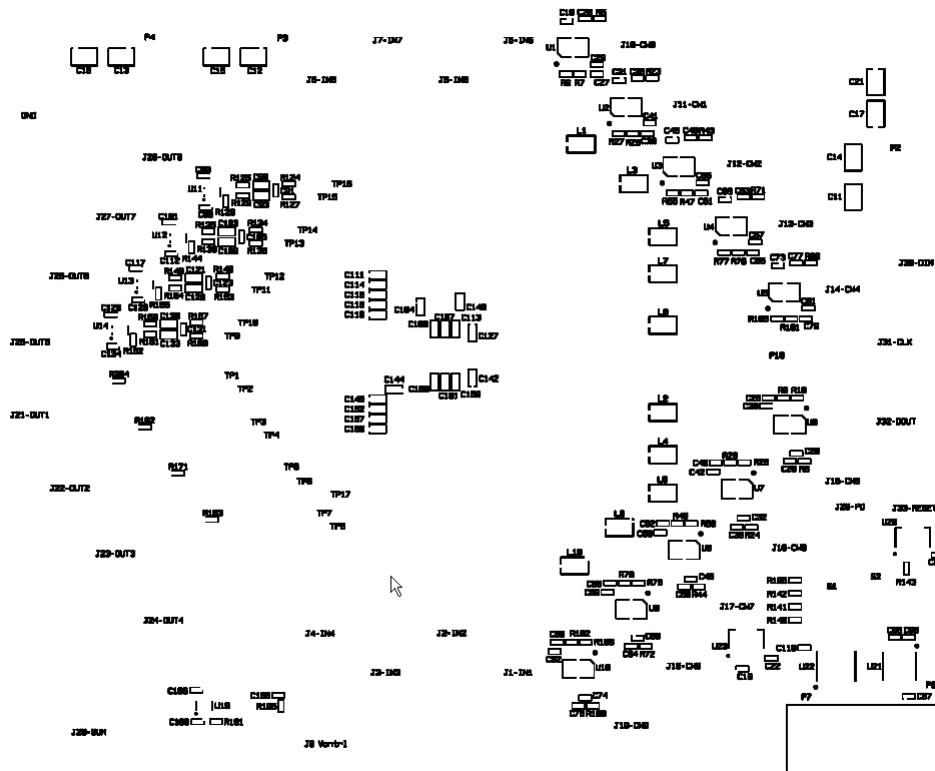

Figure 10. Silkscreen — Bottom Layer

7.2 Bill of Materials

Table 1. Bill of Materials

Item	Qty	Mfg	Mfg Part#	Ref Des	Description	Value or Function
	REF	–	VCA85XXB	–	ASSEMBLY	–
	REF	–	VCA85XXB	–	SCHEMATIC	–
	1	XX	VCA85XXB	–	FABRICATION	–
	REF	–	VCA85XXB	–	ARTWORK	–
1	19	Kemet	C0402C103K3RAC	C25, C26, C35, C36, C49, C50, C63, C64, C77, C78, C92, C106, C125, C132, C139, C156, C162, C172, C179	Capacitor, SMT, 0402	Capacitor, SMT, 0402,CER, 0.01µF, 25V, 10%, X7R
2	75	Kemet	C0402C104K8PAC	C18–C20, C22–C24, C27–C34, C39–C42, C45–C48, C51, C52, C55, C56, C59–C62, C65–C68, C73–C76, C79–C82, C87–C89, C94, C95–C99, C101, C108, C110, C112, C117, C120, C124, C128, C129, C134–C136, C143, C146, C147, C150, C155, C163, C164, C166–C168, C175, C176, C181	Capacitor, SMT, 0402	Capacitor, SMT, 0402, CER, 0.1µF, 10V, 10%, X5R
3	8	TDK	C1005X5R0J105M	C97, C102, C116, C122, C145, C151, C165, C173	Capacitor, SMT, 0402	Capacitor, SMT, 0402, CER, 1.0µF, 6.3V, 20%, X5R
4	10	Panasonic Not Installed	ECJ-0EC1H100D	C1–C10	Capacitor, SMT, 0402	Capacitor, SMT, 0402,CER, 10pF, 50V, ±0.5pF, NPO
5	8	Panasonic Not Installed	ECJ-0EC1H470J	C91, C105, C123, C131, C138, C154, C171, C178	Capacitor,SMT,0402	Capacitor, SMT, 0402, CER, 47pF, 50V, 5%, NPO
6	20	Kemet	C0603C225K9PAC	C100, C104, C107, C111, C113–115, C118, C119, C127, C142, C144, C148, C149, C152, C157, C158, C160, C161, C169	Capacitor, SMT, 0603	Capacitor, CER, SMT, 0603, 2.2µF, 6.3V, X5R, 10%
7	16	Kemet	C0603C103J5RAC	C90, C93, C103, C109, C121, C126, C130, C133, C137, C141, C153, C159, C170, C174, C177, C180	Capacitor, SMT, 0603	Capacitor, CER, COG/NPO, 50V, 5%, 0.01µF
8	8	Kemet	C1210C156K4PACTU	C11–C17, C21	Capacitor, SMT	Ceramic capacitor, SMT, 1210, 15µF, 16V, 10%, X5R
9	1	Not Installed	D1833400	BB Clamp	Clamp	Clamp, PAP64, 10X10, Tucson, 166 mils HOLE 4PL
10	33	Johnson Components	142-0701-201	J1-IN1, J2-IN2, J3-IN3, J4-IN4, J5-IN5, J6-IN6, J7-IN7, J8-IN8, J15-CW5, J16-CW6, J17-CW7, J18-CW8, J19-CW9, J14-CW4, J13-CW3, J12-CW2, J11-CW1, J10-CW0, J21-OUT1, J22-OUT2, J23-OUT3, J24-OUT4, J28-OUT8, J27-OUT7, J26-OUT6, J25-OUT5, J20-SUM, J29-PD, J30-DIN, J31-CLK, J32-DOU, J33-CS, J9 Vcntrl	CON, SMA, THU	SMA coax straight PCB Jack receptacle, 155TL, BRASS/GOLD
11	1	AMP	745781-4	P7	CONN, DSUB, 9P	DSUB, 9 Pin, R/A FEM
12	1	Molex Not Installed	015-19-0080	P10	CONN, SMT, 8P	Header, SMT, 8P, Dual row, 0.1LS, Vertical, C-GRID
13	1	C&K Not Installed	BD04	S1	DIP Switch, Thu, DIP-8	DIP Switch, THU, 8 Pins,SPSTx4, 100LS
14	1	TI	VCA8500	DUT_VCA85XX	DUT, SMT, QFN-64	DUT, SMT, QFN, RGC-64, 0.5mm LS, 9x9x1mm, THRM.PAD
15	4	Samtex	TSW-106-05-G-S	P2–P4, P6	Header, THU, 6P	Header 1X6 .1CTR
16	1	Maxim	MAX3221CAE	U21	IC, SMT, 16P	RS-232 Transceivers
17	10	TI	THS4021CD	U1–U10	IC, SMT, 8P	420 MHz High speed current feedback AMP
18	1	TI	REG104GA-2.5G4	U23	IC, SMT, SOT223-6EP	2.5V, DMOS 1A Low-dropout regulator
19	1	TI	REG104GA-3.3	U20	IC, SMT, SOT223-6EP	3.3V, DMOS 1A Low-dropout regulator
20	8	TI / Burr-Brown	OPA842IDBV	U11–U18	IC, SMT, SOT23-5	Wideband, LOW DIST, Unity-gain stable, voltage-feedback OP AMP
20B	1	TI / Burr-Brown	OPA820IDBV	U19	IC, SMT, SOT23-5	Wideband, LOW DIST, Unity-gain stable, voltage-feedback OP AMP
21	1	Cypress	CY8C2633-24PVXI	U22	IC, SMT, SSOP-20	CYPRESS PSoC Mixed-signal array

Table 1. Bill of Materials (continued)

Item	Qty	Mfg	Mfg Part#	Ref Des	Description	Value or Function
22	10	Panasonic	ELJFA221J	L1-L10	Inductor, SMT	220μH, 5%
23	1	Panasonic Parts on Order Not Installed	EVQPE104K	S2	Jumper, THRU, 2P	Square light touch switch, SMT, SPST, High-density, space saving
24	2	Solder Shorted	JUMPER-0402	W2, W3	Solder jumper, SMT, 2P, 0402	Jumper, SMT0402
25	1	Solder Short 3 pads	JUMPER-0402-3P	W1	Solder jumper, SMT, 3P	Short all 3 pads
26	26	Vishay	CRCW0402000Z	R9, R10, R27, R28, R55, R56, R77, R78, R105, R106, R124, R127, R134, R138, R148, R153, R157, R160, R164, R167, R182, R187, R196, R200, R205, R208	RES, SMT, 0402	RES, SMT, 0402, 1/16W, 0 Ω
26B	26	Vishay Not Installed	CRCW0402000Z	R7, R8, R15-R22, R25, R26, R47, R48, R75, R76, R101, R102	RES, SMT, 0402	RES, SMT, 0402, 1/16W, 0 Ω
27	10	Vishay/Dale	CRCW04021000F100	R3, R4, R13, R14, R41, R42, R69, R70, R97, R98	RES, SMT, 0402	RES, SMT, 100 Ω, 1/16W, 1%, 100ppm
28	1	Vishay/Dale	CRCW04021001F100	R195	RES, SMT, 0402	RES, SMT, 1kΩ, 1/16W, 1%, 100ppm
29	5	Vishay/Dale	CRCW04024701F100	R140-R143, R185	RES, SMT, 0402	RES, SMT, 4.7 kΩ, 1/16W, 1%, 100ppm
30	20	Vishay/Dale	CRCW040249R9F100	R5, R6, R23, R24, R43, R44, R71, R72, R99, R100, R126, R137, R151, R159, R166, R184, R190, R191, R198, R207	RES, SMT, 0402	RES, SMT, 49.9 Ω, 1/16W, 1%, 100ppm
31	16	Vishay/Dale	CRCW04021001F100	R123, R125, R131, R135, R145, R149, R156, R158, R163, R165, R171, R183, R192, R197, R204, R206	RES, SMT, 0402	RES, SMT, 0402, 1kΩ, 1%, 1/16W
32	9	Panasonic	ERJ-2RKF4020X	R173-R181	RES, SMT, 0402	RES, SMT, 0402, 402 Ω, 1%, 1/16W
33	10	Panasonic	ERJ-2RKF6341X	R1, R2, R11, R12, R37, R38, R61, R62, R89, R90	RES, SMT, 0402	RES, SMT, 0402, 6.34 kΩ, 1%, 1/16W
34	16	Vishay/Dale	CRCW0402499RFKED	R128, R129, R139, R144, R154, R155, R161, R162, R168, R169, R188, R189, R201, R202, R209, R210	RES, SMT, 0402	RES, SMT, 0402, 499 Ω, 1%, 1/16W
35	9		1902D	STANDOFFS Hex 4-40	With 1/4" 4-40 Screws	
SPECIAL NOTES AND INSTRUCTIONS						
Notes: 1) Line items 4, 5, 9, 12, 13, 23, 26B – Components are not installed.						
2) Line items 24 and 25 – W1 Short all three pads. Short W2 and W3.						
3) Line item 20B – U19 Use OPA820 in place of the OPA642						

7.3 Schematic

The schematic drawings appear on the following page.

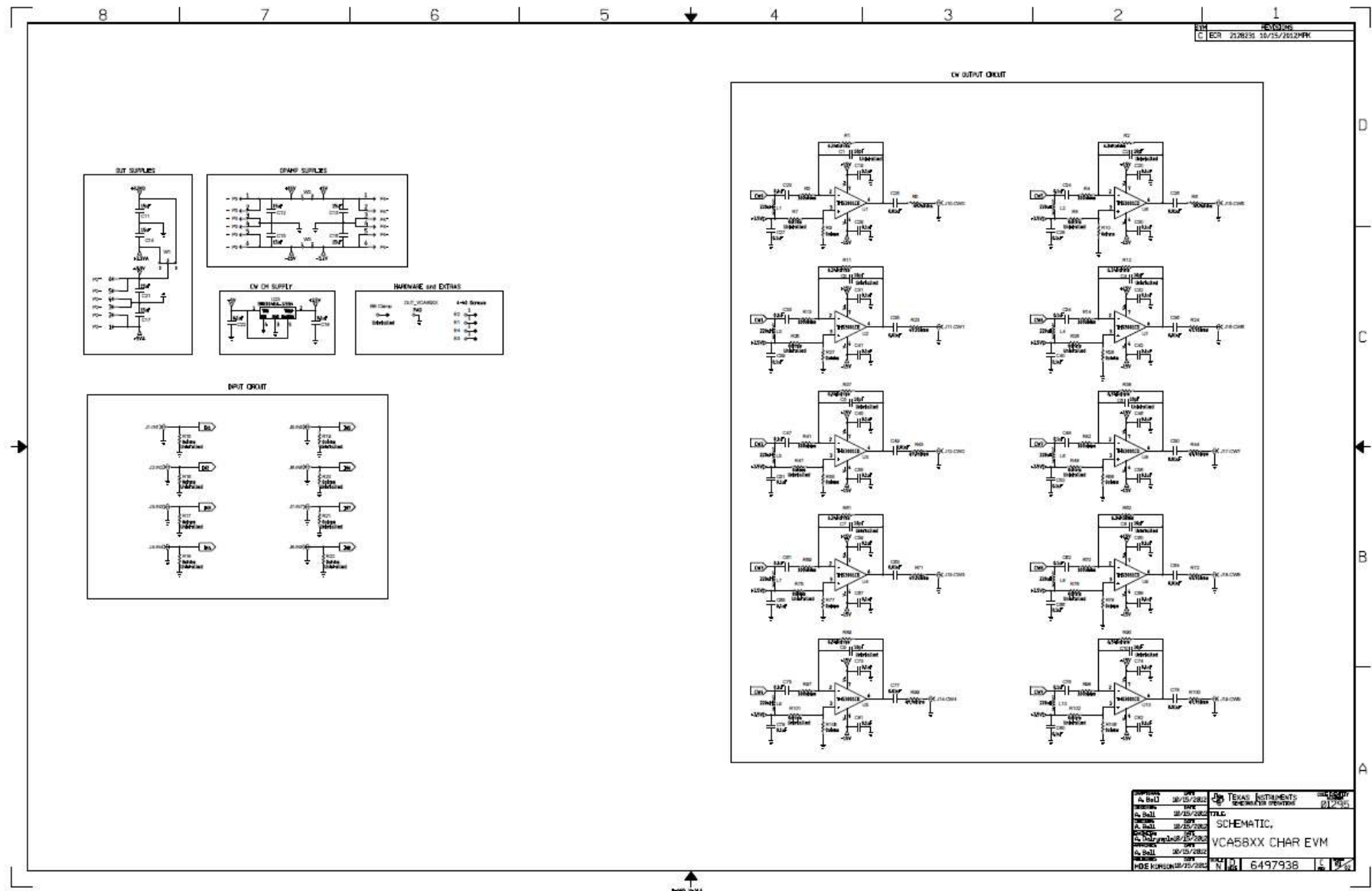

Figure 11. Schematic Pg.1

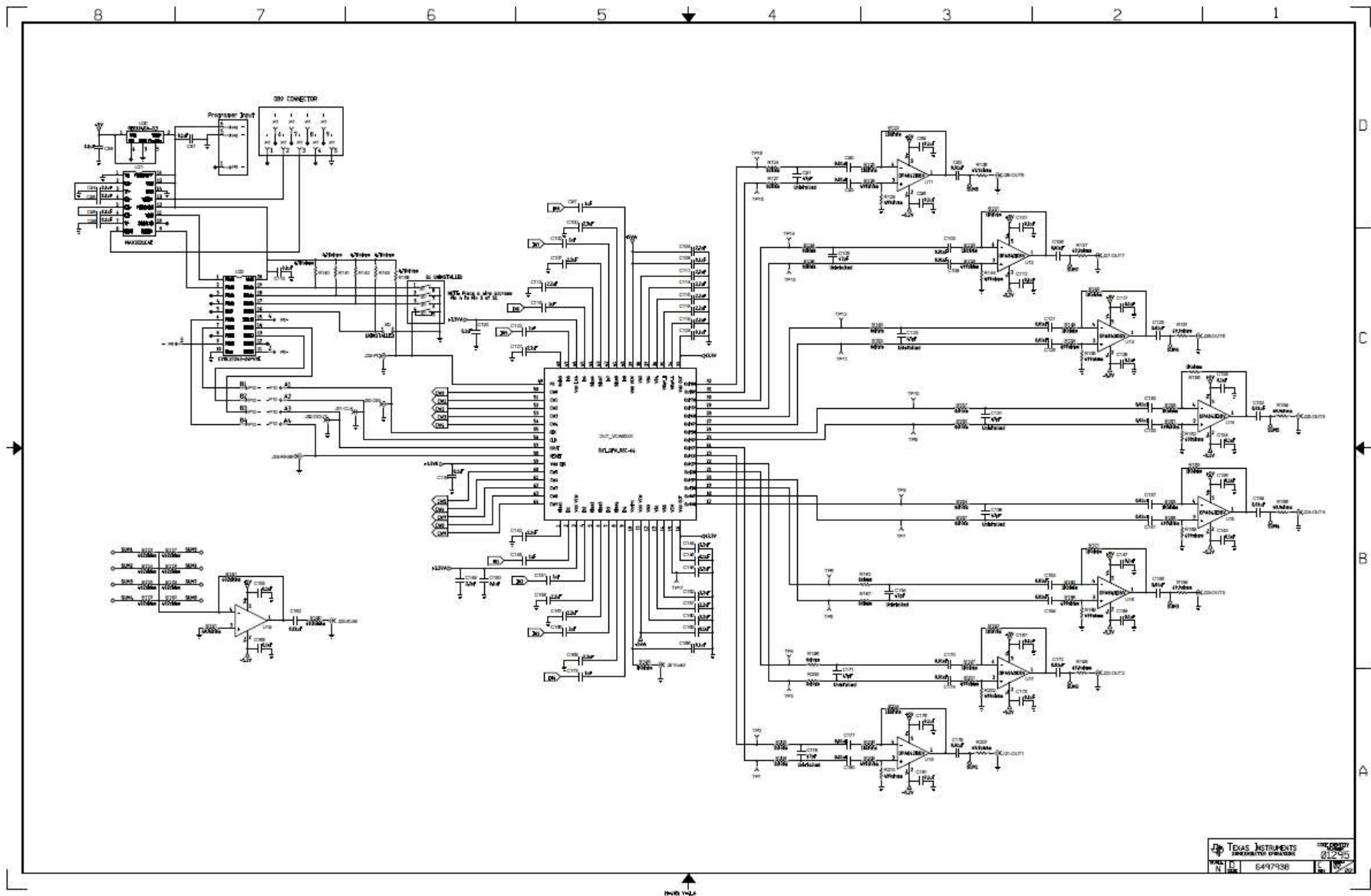

Figure 12. Schematic Pg.2

Evaluation Board/Kit Important Notice

Texas Instruments (TI) provides the enclosed product(s) under the following conditions:

This evaluation board/kit is intended for use for **ENGINEERING DEVELOPMENT, DEMONSTRATION, OR EVALUATION PURPOSES ONLY** and is not considered by TI to be a finished end-product fit for general consumer use. Persons handling the product(s) must have electronics training and observe good engineering practice standards. As such, the goods being provided are not intended to be complete in terms of required design-, marketing-, and/or manufacturing-related protective considerations, including product safety and environmental measures typically found in end products that incorporate such semiconductor components or circuit boards. This evaluation board/kit does not fall within the scope of the European Union directives regarding electromagnetic compatibility, restricted substances (RoHS), recycling (WEEE), FCC, CE or UL, and therefore may not meet the technical requirements of these directives or other related directives.

Should this evaluation board/kit not meet the specifications indicated in the User's Guide, the board/kit may be returned within 30 days from the date of delivery for a full refund. **THE FOREGOING WARRANTY IS THE EXCLUSIVE WARRANTY MADE BY SELLER TO BUYER AND IS IN LIEU OF ALL OTHER WARRANTIES, EXPRESSED, IMPLIED, OR STATUTORY, INCLUDING ANY WARRANTY OF MERCHANTABILITY OR FITNESS FOR ANY PARTICULAR PURPOSE.**

The user assumes all responsibility and liability for proper and safe handling of the goods. Further, the user indemnifies TI from all claims arising from the handling or use of the goods. Due to the open construction of the product, it is the user's responsibility to take any and all appropriate precautions with regard to electrostatic discharge.

EXCEPT TO THE EXTENT OF THE INDEMNITY SET FORTH ABOVE, NEITHER PARTY SHALL BE LIABLE TO THE OTHER FOR ANY INDIRECT, SPECIAL, INCIDENTAL, OR CONSEQUENTIAL DAMAGES.

TI currently deals with a variety of customers for products, and therefore our arrangement with the user **is not exclusive.**

TI assumes **no liability for applications assistance, customer product design, software performance, or infringement of patents or services described herein.**

Please read the User's Guide and, specifically, the Warnings and Restrictions notice in the User's Guide prior to handling the product. This notice contains important safety information about temperatures and voltages. For additional information on TI's environmental and/or safety programs, please contact the TI application engineer or visit www.ti.com/esh.

No license is granted under any patent right or other intellectual property right of TI covering or relating to any machine, process, or combination in which such TI products or services might be or are used.

FCC Warning

This evaluation board/kit is intended for use for **ENGINEERING DEVELOPMENT, DEMONSTRATION, OR EVALUATION PURPOSES ONLY** and is not considered by TI to be a finished end-product fit for general consumer use. It generates, uses, and can radiate radio frequency energy and has not been tested for compliance with the limits of computing devices pursuant to part 15 of FCC rules, which are designed to provide reasonable protection against radio frequency interference. Operation of this equipment in other environments may cause interference with radio communications, in which case the user at his own expense will be required to take whatever measures may be required to correct this interference.

EVM Warnings and Restrictions

It is important to operate this EVM within the input voltage range of and the output voltage range of .

Exceeding the specified input range may cause unexpected operation and/or irreversible damage to the EVM. If there are questions concerning the input range, please contact a TI field representative prior to connecting the input power.

Applying loads outside of the specified output range may result in unintended operation and/or possible permanent damage to the EVM. Please consult the EVM User's Guide prior to connecting any load to the EVM output. If there is uncertainty as to the load specification, please contact a TI field representative.

During normal operation, some circuit components may have case temperatures greater than . The EVM is designed to operate properly with certain components above as long as the input and output ranges are maintained. These components include but are not limited to linear regulators, switching transistors, pass transistors, and current sense resistors. These types of devices can be identified using the EVM schematic located in the EVM User's Guide. When placing measurement probes near these devices during operation, please be aware that these devices may be very warm to the touch.

Mailing Address: Texas Instruments, Post Office Box 655303, Dallas, Texas 75265
Copyright © 2013, Texas Instruments Incorporated

STANDARD TERMS AND CONDITIONS FOR EVALUATION MODULES

1. *Delivery:* TI delivers TI evaluation boards, kits, or modules, including any accompanying demonstration software, components, or documentation (collectively, an "EVM" or "EVMs") to the User ("User") in accordance with the terms and conditions set forth herein. Acceptance of the EVM is expressly subject to the following terms and conditions.
 - 1.1 EVMs are intended solely for product or software developers for use in a research and development setting to facilitate feasibility evaluation, experimentation, or scientific analysis of TI semiconductors products. EVMs have no direct function and are not finished products. EVMs shall not be directly or indirectly assembled as a part or subassembly in any finished product. For clarification, any software or software tools provided with the EVM ("Software") shall not be subject to the terms and conditions set forth herein but rather shall be subject to the applicable terms and conditions that accompany such Software
 - 1.2 EVMs are not intended for consumer or household use. EVMs may not be sold, sublicensed, leased, rented, loaned, assigned, or otherwise distributed for commercial purposes by Users, in whole or in part, or used in any finished product or production system.
2. *Limited Warranty and Related Remedies/Disclaimers:*
 - 2.1 These terms and conditions do not apply to Software. The warranty, if any, for Software is covered in the applicable Software License Agreement.
 - 2.2 TI warrants that the TI EVM will conform to TI's published specifications for ninety (90) days after the date TI delivers such EVM to User. Notwithstanding the foregoing, TI shall not be liable for any defects that are caused by neglect, misuse or mistreatment by an entity other than TI, including improper installation or testing, or for any EVMs that have been altered or modified in any way by an entity other than TI. Moreover, TI shall not be liable for any defects that result from User's design, specifications or instructions for such EVMs. Testing and other quality control techniques are used to the extent TI deems necessary or as mandated by government requirements. TI does not test all parameters of each EVM.
 - 2.3 If any EVM fails to conform to the warranty set forth above, TI's sole liability shall be at its option to repair or replace such EVM, or credit User's account for such EVM. TI's liability under this warranty shall be limited to EVMs that are returned during the warranty period to the address designated by TI and that are determined by TI not to conform to such warranty. If TI elects to repair or replace such EVM, TI shall have a reasonable time to repair such EVM or provide replacements. Repaired EVMs shall be warranted for the remainder of the original warranty period. Replaced EVMs shall be warranted for a new full ninety (90) day warranty period.
3. *Regulatory Notices:*
 - 3.1 *United States*
 - 3.1.1 *Notice applicable to EVMs not FCC-Approved:*

This kit is designed to allow product developers to evaluate electronic components, circuitry, or software associated with the kit to determine whether to incorporate such items in a finished product and software developers to write software applications for use with the end product. This kit is not a finished product and when assembled may not be resold or otherwise marketed unless all required FCC equipment authorizations are first obtained. Operation is subject to the condition that this product not cause harmful interference to licensed radio stations and that this product accept harmful interference. Unless the assembled kit is designed to operate under part 15, part 18 or part 95 of this chapter, the operator of the kit must operate under the authority of an FCC license holder or must secure an experimental authorization under part 5 of this chapter.
 - 3.1.2 *For EVMs annotated as FCC – FEDERAL COMMUNICATIONS COMMISSION Part 15 Compliant:*

CAUTION

This device complies with part 15 of the FCC Rules. Operation is subject to the following two conditions: (1) This device may not cause harmful interference, and (2) this device must accept any interference received, including interference that may cause undesired operation.

Changes or modifications not expressly approved by the party responsible for compliance could void the user's authority to operate the equipment.

FCC Interference Statement for Class A EVM devices

NOTE: This equipment has been tested and found to comply with the limits for a Class A digital device, pursuant to part 15 of the FCC Rules. These limits are designed to provide reasonable protection against harmful interference when the equipment is operated in a commercial environment. This equipment generates, uses, and can radiate radio frequency energy and, if not installed and used in accordance with the instruction manual, may cause harmful interference to radio communications. Operation of this equipment in a residential area is likely to cause harmful interference in which case the user will be required to correct the interference at his own expense.

FCC Interference Statement for Class B EVM devices

NOTE: This equipment has been tested and found to comply with the limits for a Class B digital device, pursuant to part 15 of the FCC Rules. These limits are designed to provide reasonable protection against harmful interference in a residential installation. This equipment generates, uses and can radiate radio frequency energy and, if not installed and used in accordance with the instructions, may cause harmful interference to radio communications. However, there is no guarantee that interference will not occur in a particular installation. If this equipment does cause harmful interference to radio or television reception, which can be determined by turning the equipment off and on, the user is encouraged to try to correct the interference by one or more of the following measures:

- Reorient or relocate the receiving antenna.
- Increase the separation between the equipment and receiver.
- Connect the equipment into an outlet on a circuit different from that to which the receiver is connected.
- Consult the dealer or an experienced radio/TV technician for help.

3.2 Canada

3.2.1 For EVMs issued with an Industry Canada Certificate of Conformance to RSS-210

Concerning EVMs Including Radio Transmitters:

This device complies with Industry Canada license-exempt RSS standard(s). Operation is subject to the following two conditions: (1) this device may not cause interference, and (2) this device must accept any interference, including interference that may cause undesired operation of the device.

Concernant les EVMs avec appareils radio:

Le présent appareil est conforme aux CNR d'Industrie Canada applicables aux appareils radio exempts de licence. L'exploitation est autorisée aux deux conditions suivantes: (1) l'appareil ne doit pas produire de brouillage, et (2) l'utilisateur de l'appareil doit accepter tout brouillage radioélectrique subi, même si le brouillage est susceptible d'en compromettre le fonctionnement.

Concerning EVMs Including Detachable Antennas:

Under Industry Canada regulations, this radio transmitter may only operate using an antenna of a type and maximum (or lesser) gain approved for the transmitter by Industry Canada. To reduce potential radio interference to other users, the antenna type and its gain should be so chosen that the equivalent isotropically radiated power (e.i.r.p.) is not more than that necessary for successful communication. This radio transmitter has been approved by Industry Canada to operate with the antenna types listed in the user guide with the maximum permissible gain and required antenna impedance for each antenna type indicated. Antenna types not included in this list, having a gain greater than the maximum gain indicated for that type, are strictly prohibited for use with this device.

Concernant les EVMs avec antennes détachables

Conformément à la réglementation d'Industrie Canada, le présent émetteur radio peut fonctionner avec une antenne d'un type et d'un gain maximal (ou inférieur) approuvé pour l'émetteur par Industrie Canada. Dans le but de réduire les risques de brouillage radioélectrique à l'intention des autres utilisateurs, il faut choisir le type d'antenne et son gain de sorte que la puissance isotrope rayonnée équivalente (p.i.r.e.) ne dépasse pas l'intensité nécessaire à l'établissement d'une communication satisfaisante. Le présent émetteur radio a été approuvé par Industrie Canada pour fonctionner avec les types d'antenne énumérés dans le manuel d'usage et ayant un gain admissible maximal et l'impédance requise pour chaque type d'antenne. Les types d'antenne non inclus dans cette liste, ou dont le gain est supérieur au gain maximal indiqué, sont strictement interdits pour l'exploitation de l'émetteur.

3.3 Japan

3.3.1 *Notice for EVMs delivered in Japan:* Please see http://www.tij.co.jp/lstds/ti_ja/general/eStore/notice_01.page 日本国内に輸入される評価用キット、ボードについては、次のところをご覧ください。
http://www.tij.co.jp/lstds/ti_ja/general/eStore/notice_01.page

3.3.2 *Notice for Users of EVMs Considered "Radio Frequency Products" in Japan:* EVMs entering Japan may not be certified by TI as conforming to Technical Regulations of Radio Law of Japan.

If User uses EVMs in Japan, not certified to Technical Regulations of Radio Law of Japan, User is required by Radio Law of Japan to follow the instructions below with respect to EVMs:

1. Use EVMs in a shielded room or any other test facility as defined in the notification #173 issued by Ministry of Internal Affairs and Communications on March 28, 2006, based on Sub-section 1.1 of Article 6 of the Ministry's Rule for Enforcement of Radio Law of Japan,
2. Use EVMs only after User obtains the license of Test Radio Station as provided in Radio Law of Japan with respect to EVMs, or
3. Use of EVMs only after User obtains the Technical Regulations Conformity Certification as provided in Radio Law of Japan with respect to EVMs. Also, do not transfer EVMs, unless User gives the same notice above to the transferee. Please note that if User does not follow the instructions above, User will be subject to penalties of Radio Law of Japan.

【無線電波を送信する製品の開発キットをお使いになる際の注意事項】 開発キットの中には技術基準適合証明を受けていないものがあります。技術適合証明を受けていないもののご使用に際しては、電波法遵守のため、以下のいずれかの措置を取っていただく必要がありますのでご注意ください。

1. 電波法施行規則第6条第1項第1号に基づく平成18年3月28日総務省告示第173号で定められた電波暗室等の試験設備でご使用いただく。
2. 実験局の免許を取得後ご使用いただく。
3. 技術基準適合証明を取得後ご使用いただく。

なお、本製品は、上記の「ご使用にあたっての注意」を譲渡先、移転先に通知しない限り、譲渡、移転できないものとします。

上記を遵守頂けない場合は、電波法の罰則が適用される可能性があることをご留意ください。日本テキサス・インスツルメンツ株式会社
東京都新宿区西新宿 6 丁目 2 4 番 1 号
西新宿三井ビル

3.3.3 *Notice for EVMs for Power Line Communication:* Please see http://www.tij.co.jp/llds/ti_ja/general/eStore/notice_02.page
電力線搬送波通信についての開発キットをお使いになる際の注意事項については、次のところをご覧ください。http://www.tij.co.jp/llds/ti_ja/general/eStore/notice_02.page

4 *EVM Use Restrictions and Warnings:*

4.1 EVMS ARE NOT FOR USE IN FUNCTIONAL SAFETY AND/OR SAFETY CRITICAL EVALUATIONS, INCLUDING BUT NOT LIMITED TO EVALUATIONS OF LIFE SUPPORT APPLICATIONS.

4.2 User must read and apply the user guide and other available documentation provided by TI regarding the EVM prior to handling or using the EVM, including without limitation any warning or restriction notices. The notices contain important safety information related to, for example, temperatures and voltages.

4.3 *Safety-Related Warnings and Restrictions:*

4.3.1 User shall operate the EVM within TI's recommended specifications and environmental considerations stated in the user guide, other available documentation provided by TI, and any other applicable requirements and employ reasonable and customary safeguards. Exceeding the specified performance ratings and specifications (including but not limited to input and output voltage, current, power, and environmental ranges) for the EVM may cause personal injury or death, or property damage. If there are questions concerning performance ratings and specifications, User should contact a TI field representative prior to connecting interface electronics including input power and intended loads. Any loads applied outside of the specified output range may also result in unintended and/or inaccurate operation and/or possible permanent damage to the EVM and/or interface electronics. Please consult the EVM user guide prior to connecting any load to the EVM output. If there is uncertainty as to the load specification, please contact a TI field representative. During normal operation, even with the inputs and outputs kept within the specified allowable ranges, some circuit components may have elevated case temperatures. These components include but are not limited to linear regulators, switching transistors, pass transistors, current sense resistors, and heat sinks, which can be identified using the information in the associated documentation. When working with the EVM, please be aware that the EVM may become very warm.

4.3.2 EVMs are intended solely for use by technically qualified, professional electronics experts who are familiar with the dangers and application risks associated with handling electrical mechanical components, systems, and subsystems. User assumes all responsibility and liability for proper and safe handling and use of the EVM by User or its employees, affiliates, contractors or designees. User assumes all responsibility and liability to ensure that any interfaces (electronic and/or mechanical) between the EVM and any human body are designed with suitable isolation and means to safely limit accessible leakage currents to minimize the risk of electrical shock hazard. User assumes all responsibility and liability for any improper or unsafe handling or use of the EVM by User or its employees, affiliates, contractors or designees.

4.4 User assumes all responsibility and liability to determine whether the EVM is subject to any applicable international, federal, state, or local laws and regulations related to User's handling and use of the EVM and, if applicable, User assumes all responsibility and liability for compliance in all respects with such laws and regulations. User assumes all responsibility and liability for proper disposal and recycling of the EVM consistent with all applicable international, federal, state, and local requirements.

5. *Accuracy of Information:* To the extent TI provides information on the availability and function of EVMs, TI attempts to be as accurate as possible. However, TI does not warrant the accuracy of EVM descriptions, EVM availability or other information on its websites as accurate, complete, reliable, current, or error-free.

6. *Disclaimers:*
- 6.1 EXCEPT AS SET FORTH ABOVE, EVMS AND ANY WRITTEN DESIGN MATERIALS PROVIDED WITH THE EVM (AND THE DESIGN OF THE EVM ITSELF) ARE PROVIDED "AS IS" AND "WITH ALL FAULTS." TI DISCLAIMS ALL OTHER WARRANTIES, EXPRESS OR IMPLIED, REGARDING SUCH ITEMS, INCLUDING BUT NOT LIMITED TO ANY IMPLIED WARRANTIES OF MERCHANTABILITY OR FITNESS FOR A PARTICULAR PURPOSE OR NON-INFRINGEMENT OF ANY THIRD PARTY PATENTS, COPYRIGHTS, TRADE SECRETS OR OTHER INTELLECTUAL PROPERTY RIGHTS.
- 6.2 EXCEPT FOR THE LIMITED RIGHT TO USE THE EVM SET FORTH HEREIN, NOTHING IN THESE TERMS AND CONDITIONS SHALL BE CONSTRUED AS GRANTING OR CONFERRING ANY RIGHTS BY LICENSE, PATENT, OR ANY OTHER INDUSTRIAL OR INTELLECTUAL PROPERTY RIGHT OF TI, ITS SUPPLIERS/LICENSORS OR ANY OTHER THIRD PARTY, TO USE THE EVM IN ANY FINISHED END-USER OR READY-TO-USE FINAL PRODUCT, OR FOR ANY INVENTION, DISCOVERY OR IMPROVEMENT MADE, CONCEIVED OR ACQUIRED PRIOR TO OR AFTER DELIVERY OF THE EVM.
7. *USER'S INDEMNITY OBLIGATIONS AND REPRESENTATIONS.* USER WILL DEFEND, INDEMNIFY AND HOLD TI, ITS LICENSORS AND THEIR REPRESENTATIVES HARMLESS FROM AND AGAINST ANY AND ALL CLAIMS, DAMAGES, LOSSES, EXPENSES, COSTS AND LIABILITIES (COLLECTIVELY, "CLAIMS") ARISING OUT OF OR IN CONNECTION WITH ANY HANDLING OR USE OF THE EVM THAT IS NOT IN ACCORDANCE WITH THESE TERMS AND CONDITIONS. THIS OBLIGATION SHALL APPLY WHETHER CLAIMS ARISE UNDER STATUTE, REGULATION, OR THE LAW OF TORT, CONTRACT OR ANY OTHER LEGAL THEORY, AND EVEN IF THE EVM FAILS TO PERFORM AS DESCRIBED OR EXPECTED.
8. *Limitations on Damages and Liability:*
- 8.1 *General Limitations.* IN NO EVENT SHALL TI BE LIABLE FOR ANY SPECIAL, COLLATERAL, INDIRECT, PUNITIVE, INCIDENTAL, CONSEQUENTIAL, OR EXEMPLARY DAMAGES IN CONNECTION WITH OR ARISING OUT OF THESE TERMS AND CONDITIONS OR THE USE OF THE EVMS PROVIDED HEREUNDER, REGARDLESS OF WHETHER TI HAS BEEN ADVISED OF THE POSSIBILITY OF SUCH DAMAGES. EXCLUDED DAMAGES INCLUDE, BUT ARE NOT LIMITED TO, COST OF REMOVAL OR REINSTALLATION, ANCILLARY COSTS TO THE PROCUREMENT OF SUBSTITUTE GOODS OR SERVICES, RETESTING, OUTSIDE COMPUTER TIME, LABOR COSTS, LOSS OF GOODWILL, LOSS OF PROFITS, LOSS OF SAVINGS, LOSS OF USE, LOSS OF DATA, OR BUSINESS INTERRUPTION. NO CLAIM, SUIT OR ACTION SHALL BE BROUGHT AGAINST TI MORE THAN ONE YEAR AFTER THE RELATED CAUSE OF ACTION HAS OCCURRED.
- 8.2 *Specific Limitations.* IN NO EVENT SHALL TI'S AGGREGATE LIABILITY FROM ANY WARRANTY OR OTHER OBLIGATION ARISING OUT OF OR IN CONNECTION WITH THESE TERMS AND CONDITIONS, OR ANY USE OF ANY TI EVM PROVIDED HEREUNDER, EXCEED THE TOTAL AMOUNT PAID TO TI FOR THE PARTICULAR UNITS SOLD UNDER THESE TERMS AND CONDITIONS WITH RESPECT TO WHICH LOSSES OR DAMAGES ARE CLAIMED. THE EXISTENCE OF MORE THAN ONE CLAIM AGAINST THE PARTICULAR UNITS SOLD TO USER UNDER THESE TERMS AND CONDITIONS SHALL NOT ENLARGE OR EXTEND THIS LIMIT.
9. *Return Policy.* Except as otherwise provided, TI does not offer any refunds, returns, or exchanges. Furthermore, no return of EVM(s) will be accepted if the package has been opened and no return of the EVM(s) will be accepted if they are damaged or otherwise not in a resalable condition. If User feels it has been incorrectly charged for the EVM(s) it ordered or that delivery violates the applicable order, User should contact TI. All refunds will be made in full within thirty (30) working days from the return of the components(s), excluding any postage or packaging costs.
10. *Governing Law:* These terms and conditions shall be governed by and interpreted in accordance with the laws of the State of Texas, without reference to conflict-of-laws principles. User agrees that non-exclusive jurisdiction for any dispute arising out of or relating to these terms and conditions lies within courts located in the State of Texas and consents to venue in Dallas County, Texas. Notwithstanding the foregoing, any judgment may be enforced in any United States or foreign court, and TI may seek injunctive relief in any United States or foreign court.

Mailing Address: Texas Instruments, Post Office Box 655303, Dallas, Texas 75265
Copyright © 2015, Texas Instruments Incorporated

IMPORTANT NOTICE

Texas Instruments Incorporated and its subsidiaries (TI) reserve the right to make corrections, enhancements, improvements and other changes to its semiconductor products and services per JESD46, latest issue, and to discontinue any product or service per JESD48, latest issue. Buyers should obtain the latest relevant information before placing orders and should verify that such information is current and complete. All semiconductor products (also referred to herein as "components") are sold subject to TI's terms and conditions of sale supplied at the time of order acknowledgment.

TI warrants performance of its components to the specifications applicable at the time of sale, in accordance with the warranty in TI's terms and conditions of sale of semiconductor products. Testing and other quality control techniques are used to the extent TI deems necessary to support this warranty. Except where mandated by applicable law, testing of all parameters of each component is not necessarily performed.

TI assumes no liability for applications assistance or the design of Buyers' products. Buyers are responsible for their products and applications using TI components. To minimize the risks associated with Buyers' products and applications, Buyers should provide adequate design and operating safeguards.

TI does not warrant or represent that any license, either express or implied, is granted under any patent right, copyright, mask work right, or other intellectual property right relating to any combination, machine, or process in which TI components or services are used. Information published by TI regarding third-party products or services does not constitute a license to use such products or services or a warranty or endorsement thereof. Use of such information may require a license from a third party under the patents or other intellectual property of the third party, or a license from TI under the patents or other intellectual property of TI.

Reproduction of significant portions of TI information in TI data books or data sheets is permissible only if reproduction is without alteration and is accompanied by all associated warranties, conditions, limitations, and notices. TI is not responsible or liable for such altered documentation. Information of third parties may be subject to additional restrictions.

Resale of TI components or services with statements different from or beyond the parameters stated by TI for that component or service voids all express and any implied warranties for the associated TI component or service and is an unfair and deceptive business practice. TI is not responsible or liable for any such statements.

Buyer acknowledges and agrees that it is solely responsible for compliance with all legal, regulatory and safety-related requirements concerning its products, and any use of TI components in its applications, notwithstanding any applications-related information or support that may be provided by TI. Buyer represents and agrees that it has all the necessary expertise to create and implement safeguards which anticipate dangerous consequences of failures, monitor failures and their consequences, lessen the likelihood of failures that might cause harm and take appropriate remedial actions. Buyer will fully indemnify TI and its representatives against any damages arising out of the use of any TI components in safety-critical applications.

In some cases, TI components may be promoted specifically to facilitate safety-related applications. With such components, TI's goal is to help enable customers to design and create their own end-product solutions that meet applicable functional safety standards and requirements. Nonetheless, such components are subject to these terms.

No TI components are authorized for use in FDA Class III (or similar life-critical medical equipment) unless authorized officers of the parties have executed a special agreement specifically governing such use.

Only those TI components which TI has specifically designated as military grade or "enhanced plastic" are designed and intended for use in military/aerospace applications or environments. Buyer acknowledges and agrees that any military or aerospace use of TI components which have **not** been so designated is solely at the Buyer's risk, and that Buyer is solely responsible for compliance with all legal and regulatory requirements in connection with such use.

TI has specifically designated certain components as meeting ISO/TS16949 requirements, mainly for automotive use. In any case of use of non-designated products, TI will not be responsible for any failure to meet ISO/TS16949.

Products

Audio	www.ti.com/audio
Amplifiers	amplifier.ti.com
Data Converters	dataconverter.ti.com
DLP® Products	www.dlp.com
DSP	dsp.ti.com
Clocks and Timers	www.ti.com/clocks
Interface	interface.ti.com
Logic	logic.ti.com
Power Mgmt	power.ti.com
Microcontrollers	microcontroller.ti.com
RFID	www.ti-rfid.com
OMAP Applications Processors	www.ti.com/omap
Wireless Connectivity	www.ti.com/wirelessconnectivity

Applications

Automotive and Transportation	www.ti.com/automotive
Communications and Telecom	www.ti.com/communications
Computers and Peripherals	www.ti.com/computers
Consumer Electronics	www.ti.com/consumer-apps
Energy and Lighting	www.ti.com/energy
Industrial	www.ti.com/industrial
Medical	www.ti.com/medical
Security	www.ti.com/security
Space, Avionics and Defense	www.ti.com/space-avionics-defense
Video and Imaging	www.ti.com/video

TI E2E Community

e2e.ti.com