



TAOGLAS®



Datasheet

Part No:
GA.111.101111

Description:
3dBi Mini Magnetic Mount 4G Cellular Antenna
698~960MHz, 1400~1518MHz, 1710~2700MHz

Features:
Covers worldwide 4G bands
Typical 30%+ Efficiency and 3dBi Peak Gain
Robust High Strength Magnet Mount
Cable: 1m RG-174
Connector: SMA(M)
Dimensions: 82.8*30*7.8mm
RoHS & Reach Compliant

1. Introduction	3
2. Specifications	4
3. Antenna Characteristics	7
4. Radiation Patterns	9
5. Mechanical Drawing	22
6. Magnetic Pull Force	23
7. Packaging	24
8. Application Note	25
<hr/>	
Changelog	29

Taoglas makes no warranties based on the accuracy or completeness of the contents of this document and reserves the right to make changes to specifications and product descriptions at any time without notice. Taoglas reserves all rights to this document and the information contained herein. Reproduction, use or disclosure to third parties without express permission is strictly prohibited.



1. Introduction



The GA.111 magnetic ultra-wideband cellular antenna delivers stable high omnidirectional gain and efficiencies across all common 4G, 3G and 2G global cellular bands from 698MHz to 2.7GHz.

Typical Applications Include:

- Payment Terminals
- Smart Metering
- Smart Home

This high performing antenna can be used for all cellular devices and will not require changing antennas when deploying from country to country or technology to technology like CDMA to GSM. Being magnetic mount, it is designed to be mounted on a ground plane for optimal performance. A reliable return loss of < -5dB when mounted on a metal plate ensures it complies with the industry standards set by module makers and networks worldwide. Taoglas recommends using the antenna with 1m cable length or less and can provide customized connectors and cable lengths upon customer requirements.

The strong magnet base is extremely stable and robust, using only high-quality neodymium magnets for a secure magnetic mount to ensure a high pull force to disengage.

Cables and connectors are customizable. Contact your regional Taoglas customer support team for further information.

2. Specifications

LTE Electrical									
Band	Frequency (MHz)	Measurement	Efficiency (%)	Average Gain (dB)	Peak Gain (dBi)	Impedance	Polarization	Radiation Pattern	Max. input power
4G/3G Band 12,13,14,17,28,29	698-806	30x30cm Ground Plane.	61.2	-2.13	3.22	50 Ω	Linear	Omni	2W
		Free Space.	48.5	-3.14	3.21				
4G/3G/NB-IoT/Cat M Band 5,8,18,19,20,26,27	824-960	30x30cm Ground Plane.	56.6	-2.48	2.57				
		Free Space.	46.7	-3.30	2.77				
5G NR/4G Band 21,32,74,75,76	1427-1518	30x30cm Ground Plane.	37.5	-4.26	0.00				
		Free Space.	44.6	-3.51	1.65				
4G/3G Band 1,2,3,4,9,23,25,35,39,66	1710-2200	30x30cm Ground Plane.	43.8	-3.58	3.25				
		Free Space.	46.2	-3.36	2.22				
4G/3G Band 7,30,38,40,41	2300-2690	30x30cm Ground Plane.	45.2	-3.44	3.04				
		Free Space.	45.7	-3.40	3.13				

5G/4G Bands				
Band Number	5G NR / FR1 / LTE / LTE-Advanced / WCDMA / HSPA / HSPA+ / TD-SCDMA			
	Uplink	Downlink	30x30cm Ground Plane.	Free Space.
B1	1920 to 1980	2110 to 2170	✓	✓
B2	1850 to 1910	1930 to 1990	✓	✓
B3	1710 to 1785	1805 to 1880	✓	✓
B4	1710 to 1755	2110 to 2155	✓	✓
B5	824 to 849	869 to 894	✓	✓
B7	2500 to 2570	2620 to 2690	✓	✓
B8	880 to 915	925 to 960	✓	✓
B9*	1749.9 to 1784.9	1844.9 to 1879.9	✓	✓
B11	1427.9 to 1447.9	1475.9 to 1495.9	✓	✓
B12	699 to 716	729 to 746	✓	✓
B13	777 to 787	746 to 756	✓	✓
B14	788 to 798	758 to 768	✓	✓
B17	704 to 716	734 to 746	✓	✓
B18	815 to 830	860 to 875	✓	✓
B19	830 to 845	875 to 890	✓	✓
B20	832 to 862	791 to 821	✓	✓
B21	1447.9 to 1462.9	1495.9 to 1510.9	✓	✓
B22*	3410 to 3490	3510 to 3590	✓	✓
B23*	2000 to 2020	2180 to 2200	✓	✓
B24	1626.5 to 1660.5	1525 to 1559	✓	✓

B25	1850 to 1915	1930 to 1995	✓	✓
B26	814 to 849	859 to 894	✓	✓
B27*	807 to 824	852 to 869	✓	✓
B28	703 to 748	758 to 803	✓	✓
B29	717 to 728		✓	✓
B30	2305 to 2315	2350 to 2360	✓	✓
B31	452.5 to 457.5	462.5 to 467.5	✗	✗
B32	1452 to 1496		✓	✓
B34	2010 to 2025		✓	✓
B35	1850 to 1910		✓	✓
B36	1930 to 1990		✓	✓
B37	1910 to 1930		✓	✓
B38	2570 to 2620		✓	✓
B39	1880 to 1920		✓	✓
B40	2300 to 2400		✓	✓
B41	2496 to 2690		✓	✓
B42	3400 to 3600		✓	✓
B43	3600 to 3800		✓	✓
B45	1447 to 1467		✓	✓
B46	5150 to 5925		✗	✓
B47	5855 to 5925		✗	✗
B48	3550 to 3700		✓	✓
B49	3550 to 3700		✓	✓
B50	1432 to 1517		✓	✓
B51	1427 to 1432		✓	✓
B52	3300 to 3400		✓	✓
B53	2483.5 to 2495		✓	✓
B65	1920 to 2010	2110 to 2200	✓	✓
B66	1710 to 1780	2110 to 2200	✓	✓
B68	698 to 728	753 to 783	✓	✓
B69	2570 to 2620		✓	✓
B70	1695 to 1710	1995 to 2020	✓	✓
B71	663 to 698	617 to 652	✓	✓
B72	451 to 456	461 to 466	✗	✗
B73	450 to 455	460 to 465	✗	✗
B74	1427 to 1470	1475 to 1518	✓	✓
B75	1432 to 1517		✓	✓
B76	1427 to 1432		✓	✓
B77	3300 to 4200		✓	✓
B78	3300 to 3800		✓	✓
B79	4400 to 5000		✗	✗

B85	698 to 716	728 to 746	✓	✓
B87	410 to 415	420 to 425	✗	✗
B88	412 to 417	422 to 427	✗	✗

Mechanical	
Dimensions (mm)	82.8*30*7.8
Cable	1 Meter RG-174 Coaxial Cable
Casing	TPEE
Connector	SMA(M)
Magnetic Pull Force.	Vertical: <1.8Kgf Horizontal:<0.8Kgf
Weight	43g
Environmental	
Temperature Range	-40°C to 85°C
Humidity	Non-condensing 65°C 95% RH

3. Antenna Characteristics

3.1 Return Loss

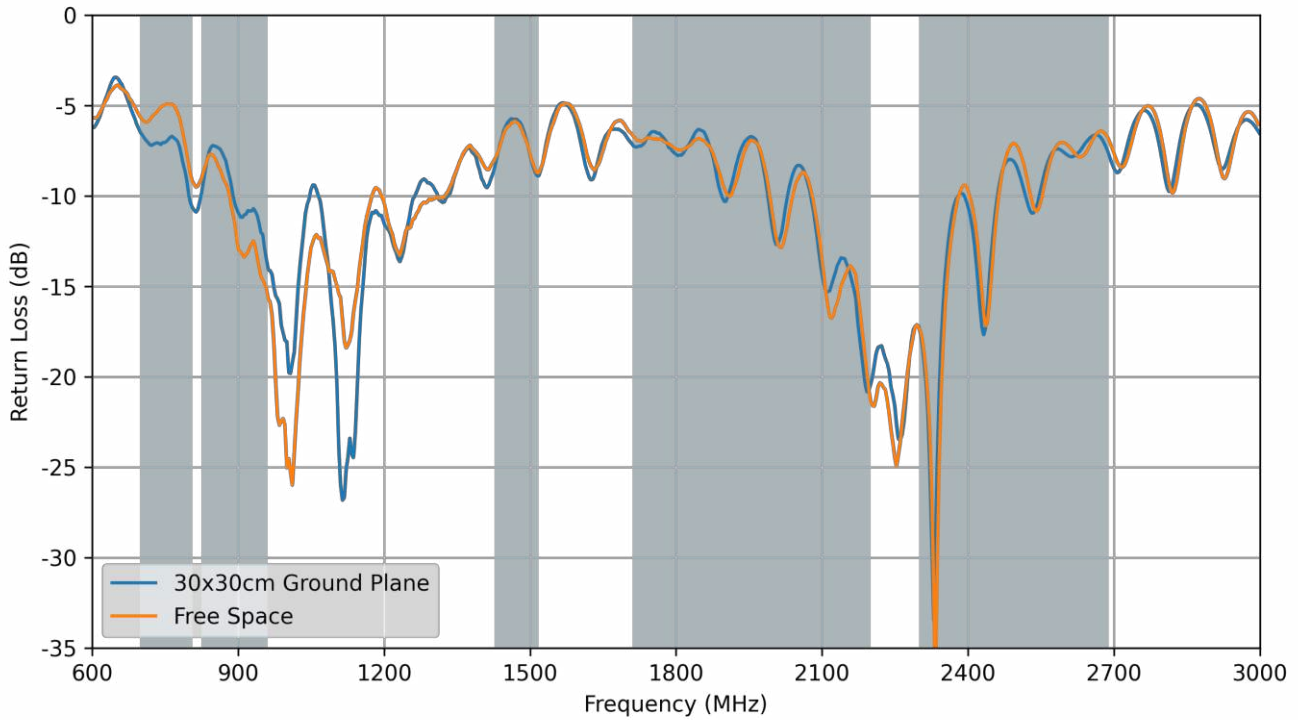

3.2 Efficiency

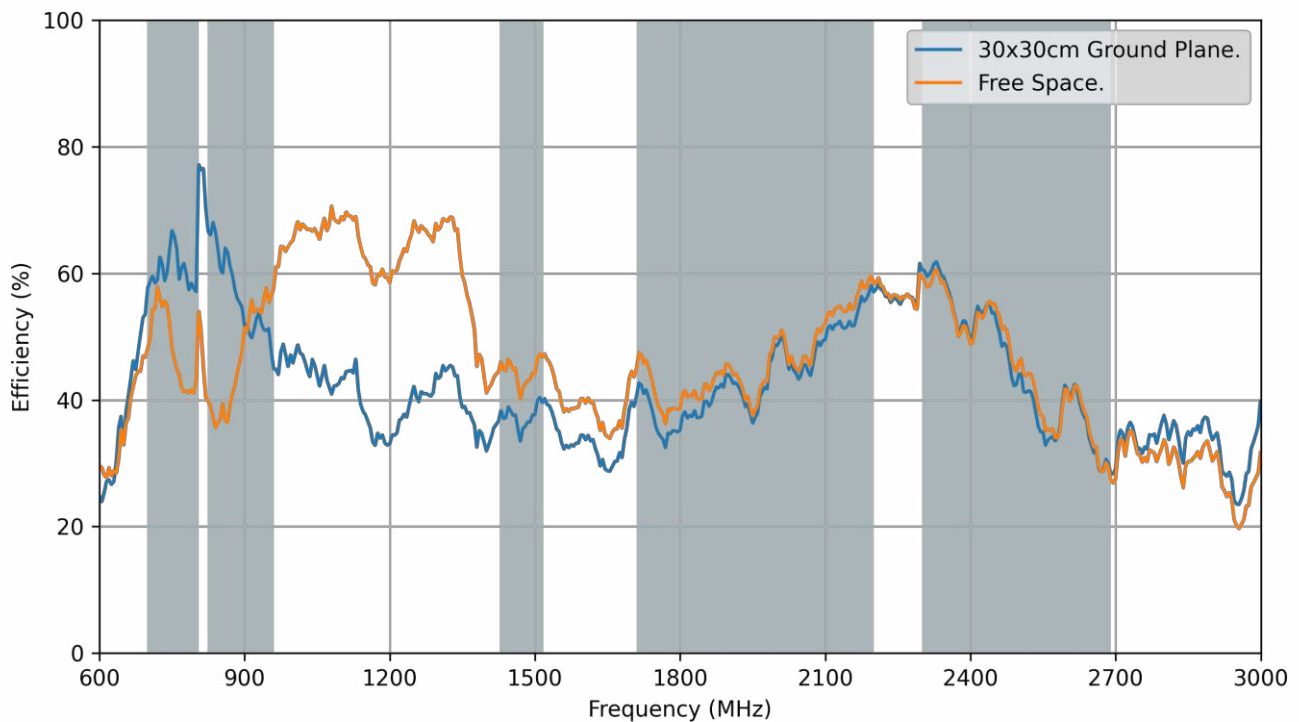

3.3 Peak Gain

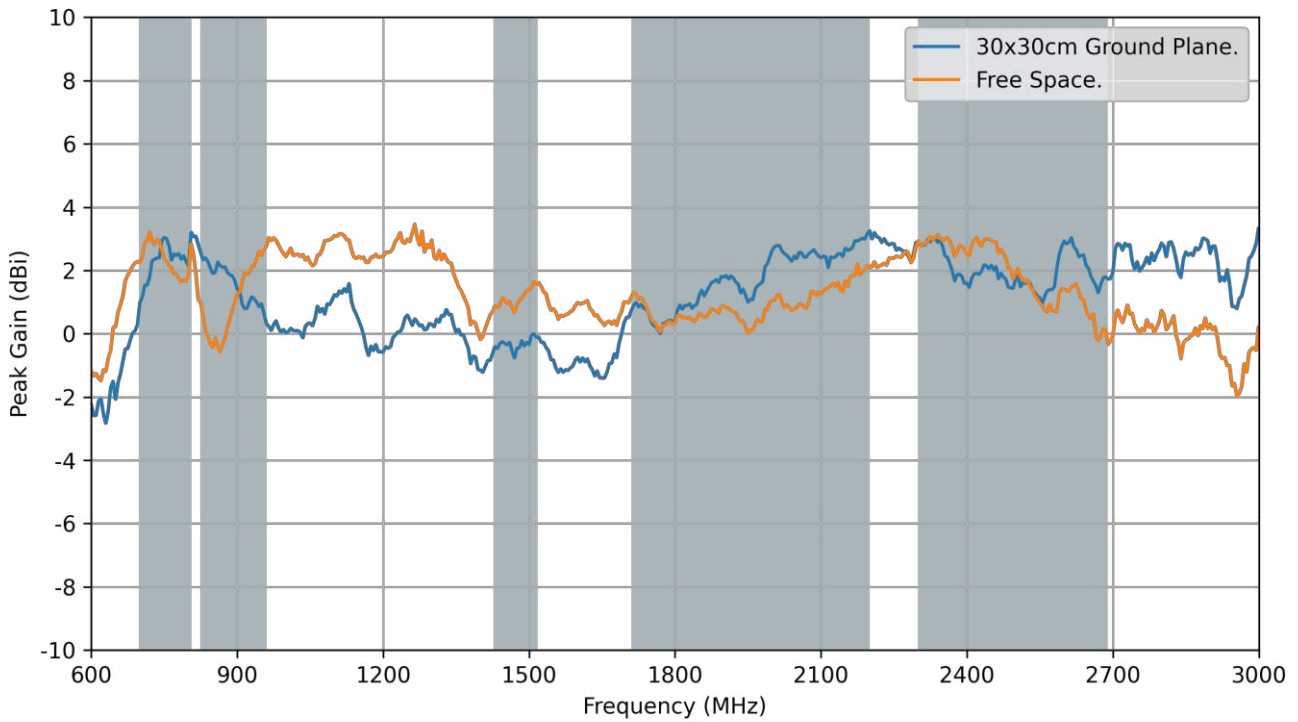

3.4 Average Gain

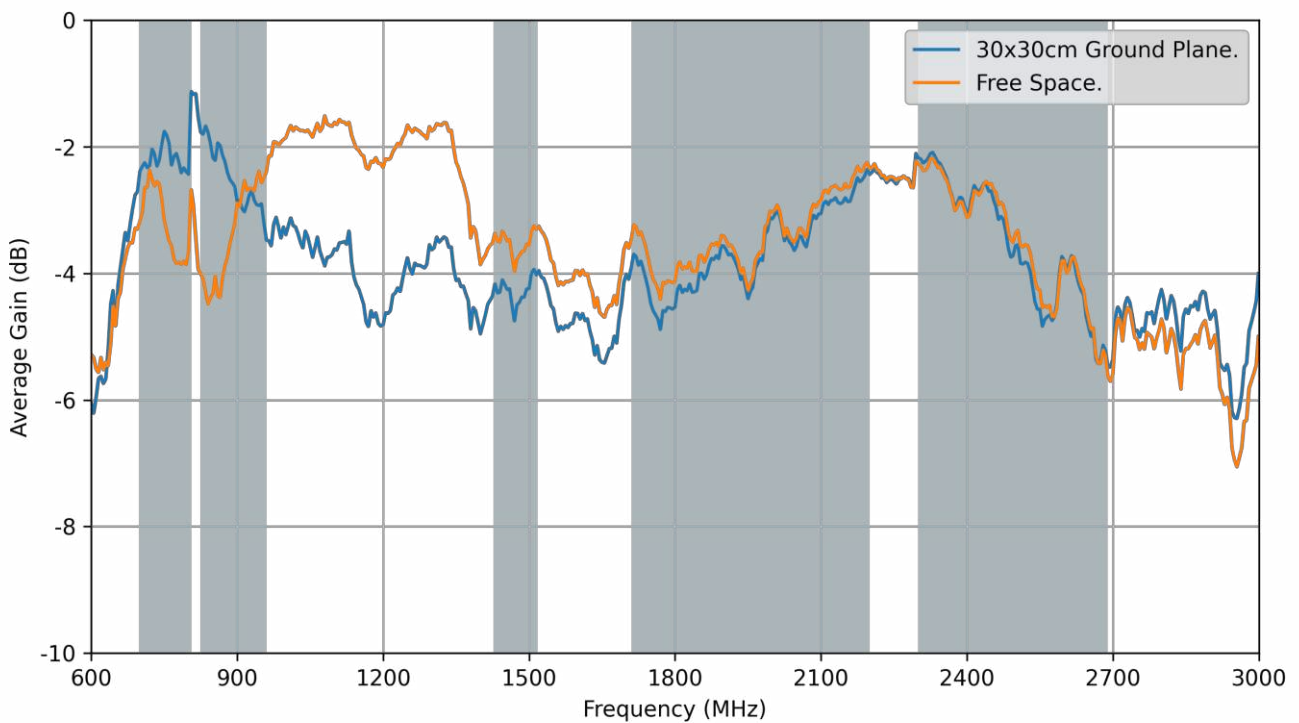

4. Radiation Patterns

4.1 Test Setup

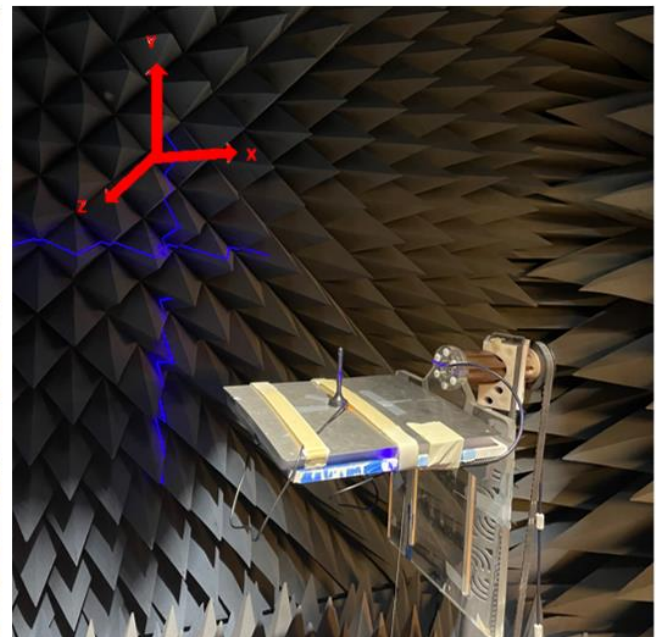
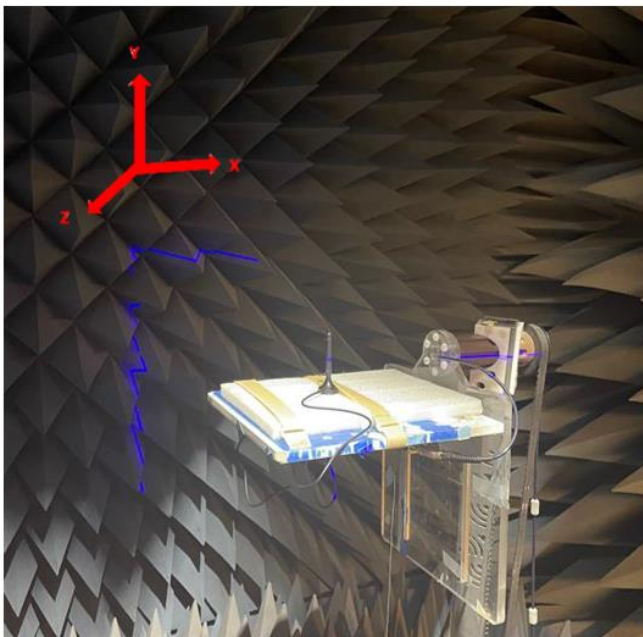
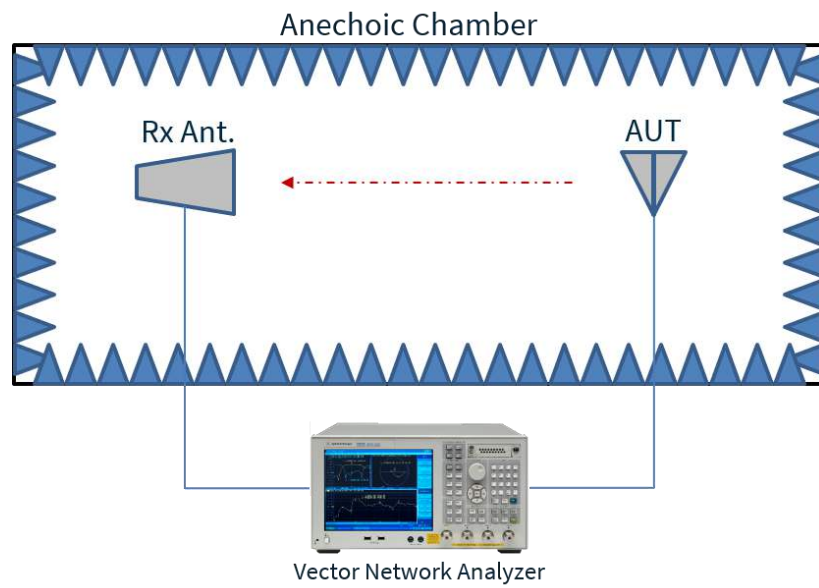

4.2 Patterns at 705 MHz 30x30cm Ground Plane.

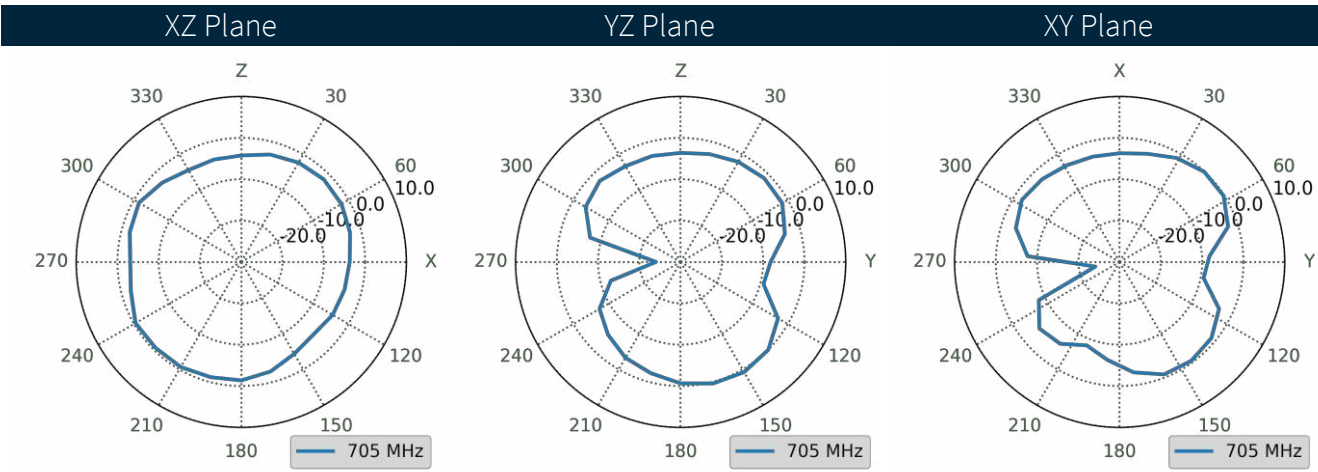
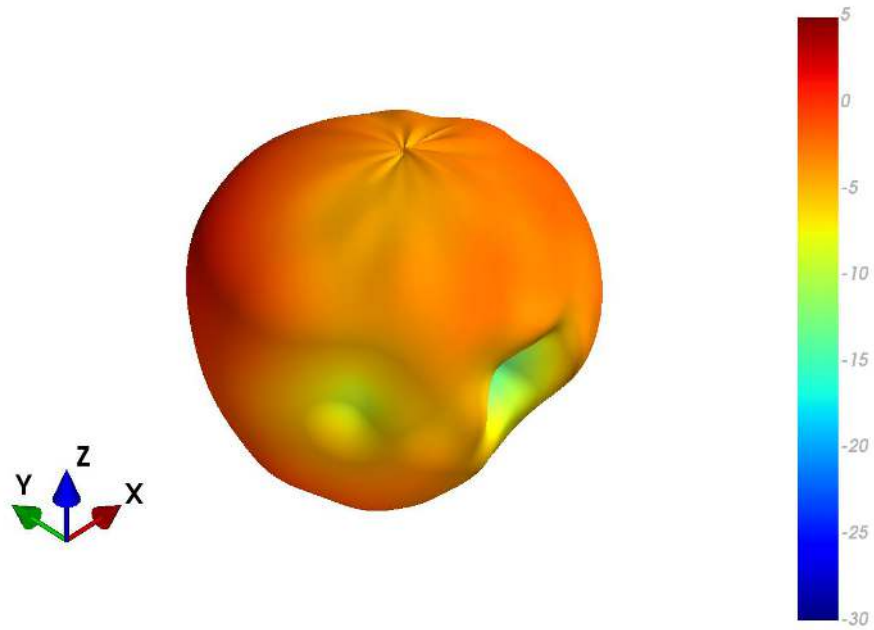

4.3 Patterns at 705 MHz Free Space

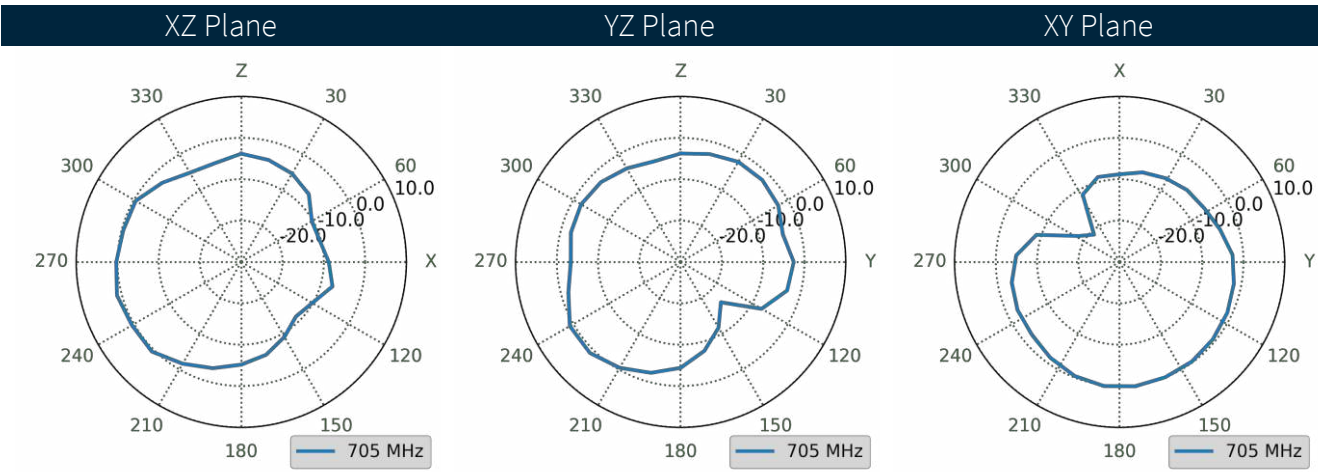
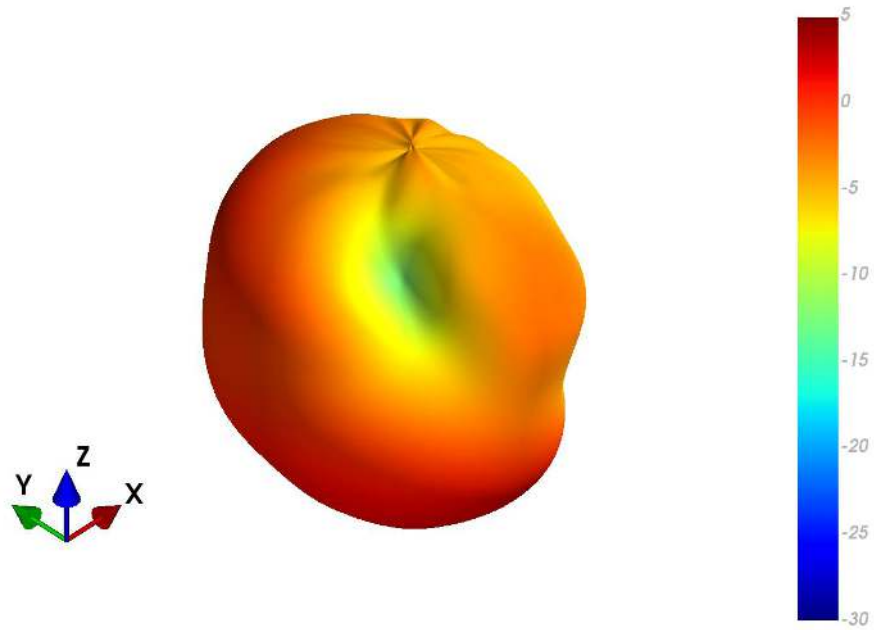

4.4 Patterns at 960 MHz 30x30cm Ground Plane

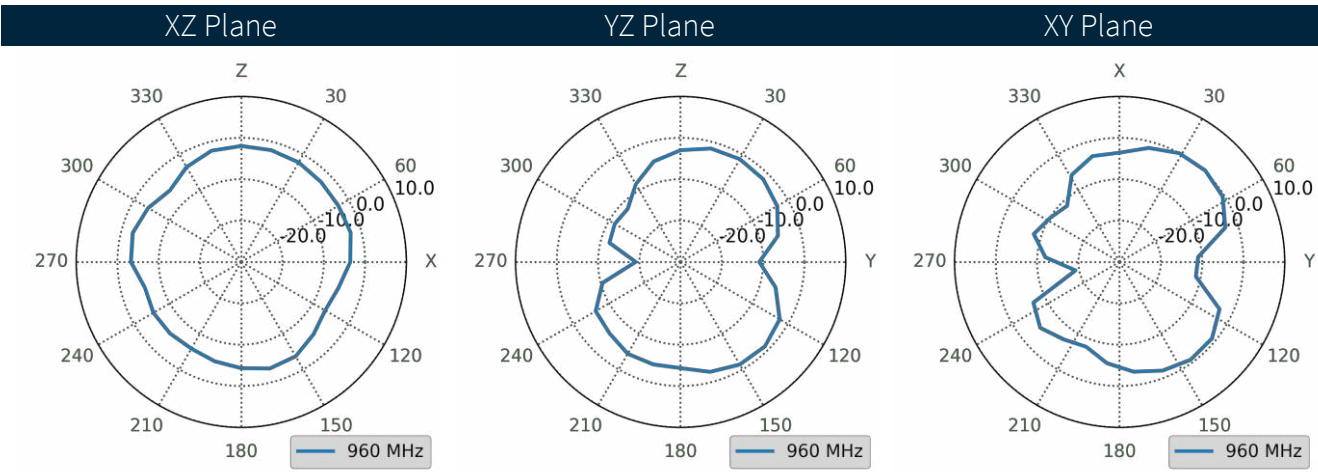
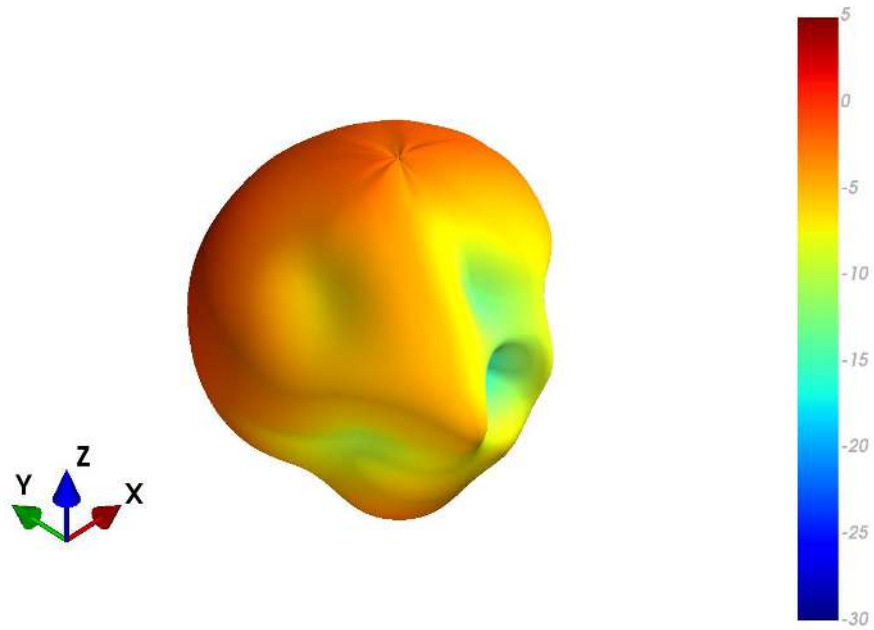

4.5 Patterns at 960 MHz Free Space

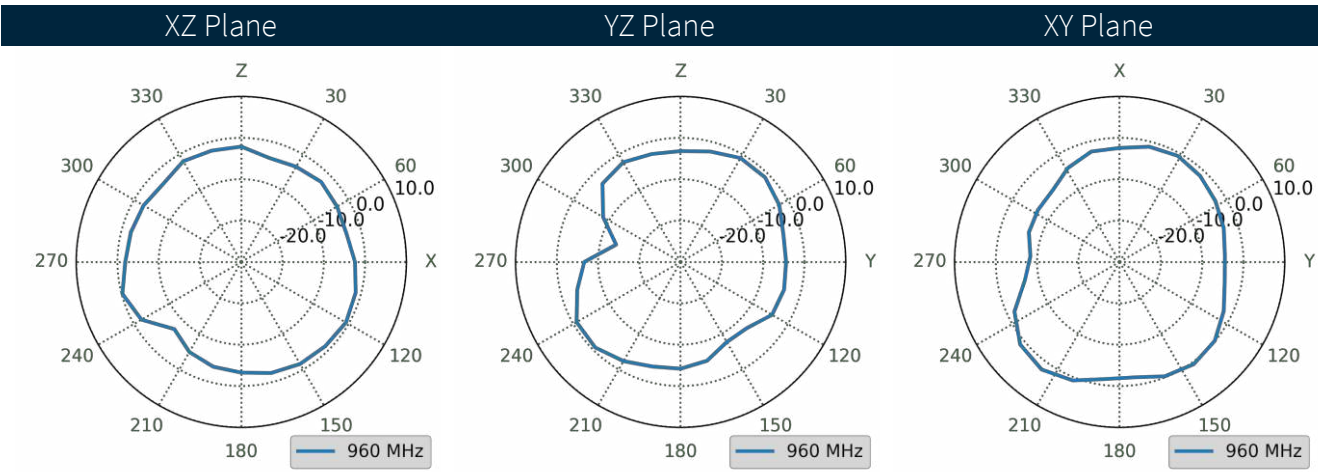
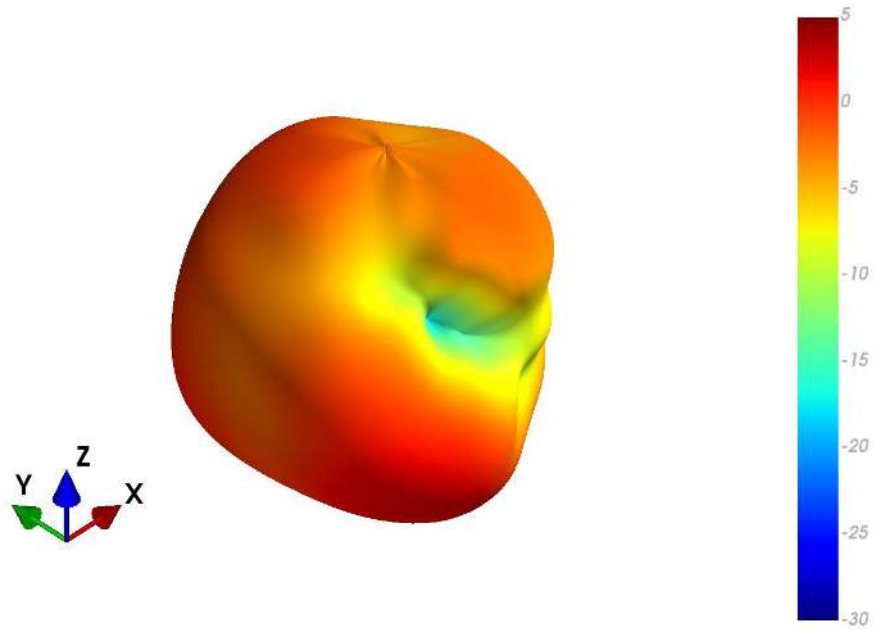

4.6 Patterns at 1710 MHz 30x30cm Ground Plane

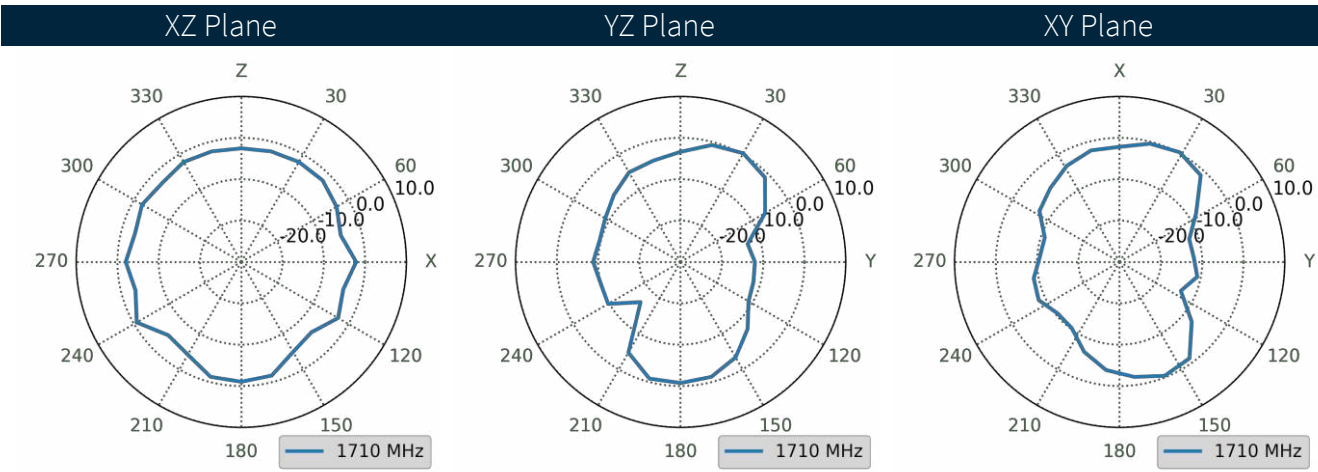
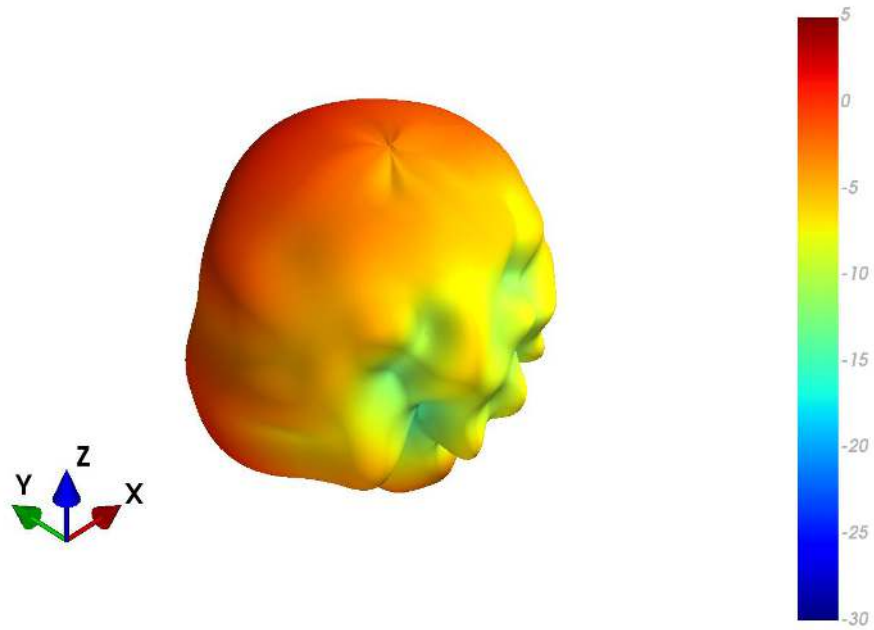

4.7 Patterns at 1710 MHz Free Space

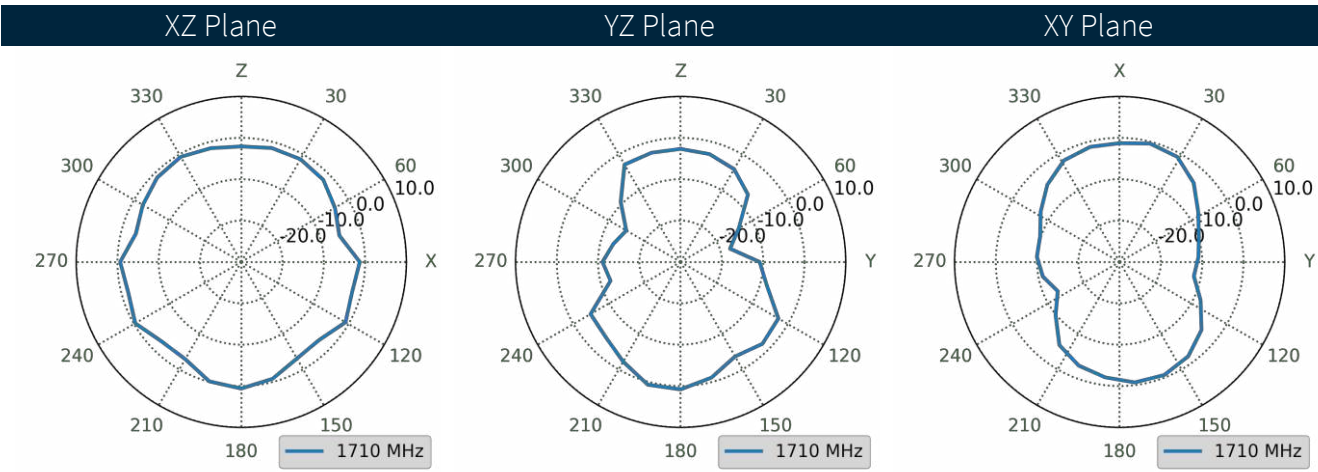
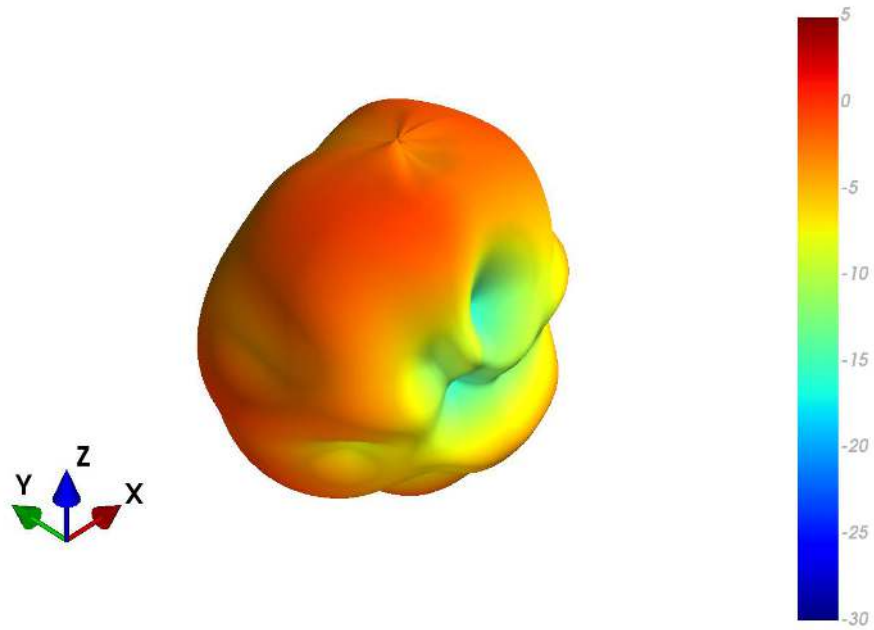

4.8 Patterns at 2170 MHz 30x30cm Ground Plane

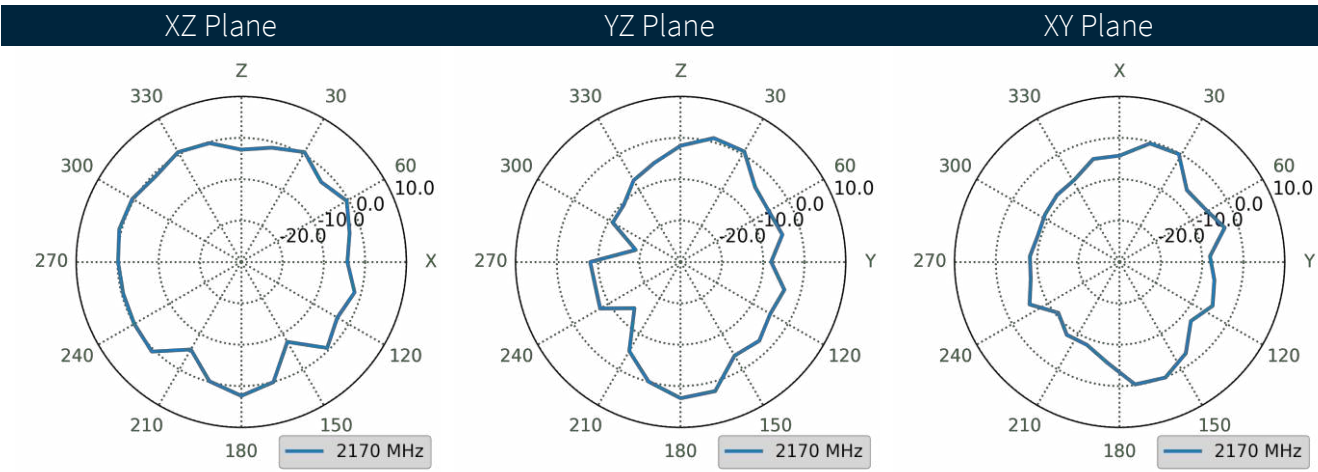
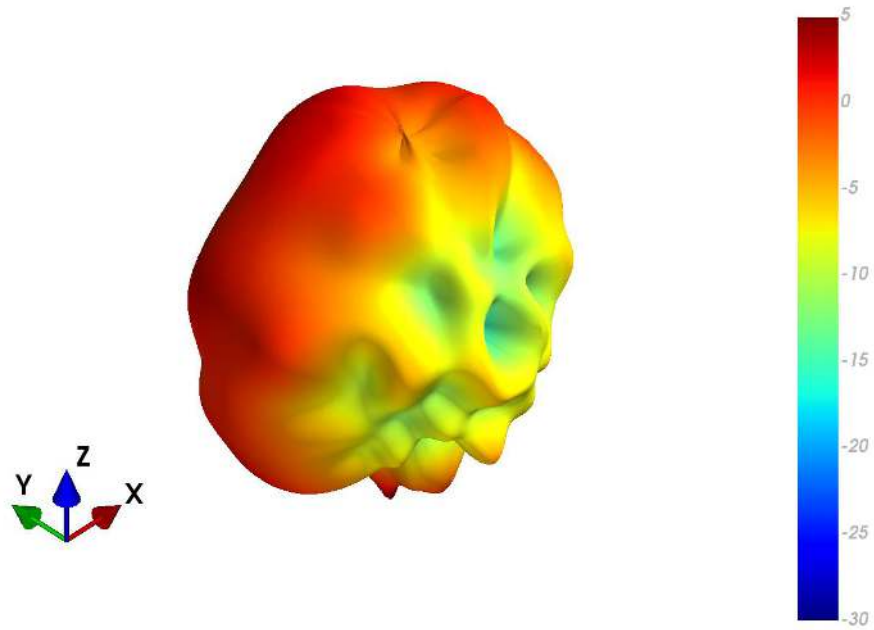

4.9 Patterns at 2170 MHz Free Space

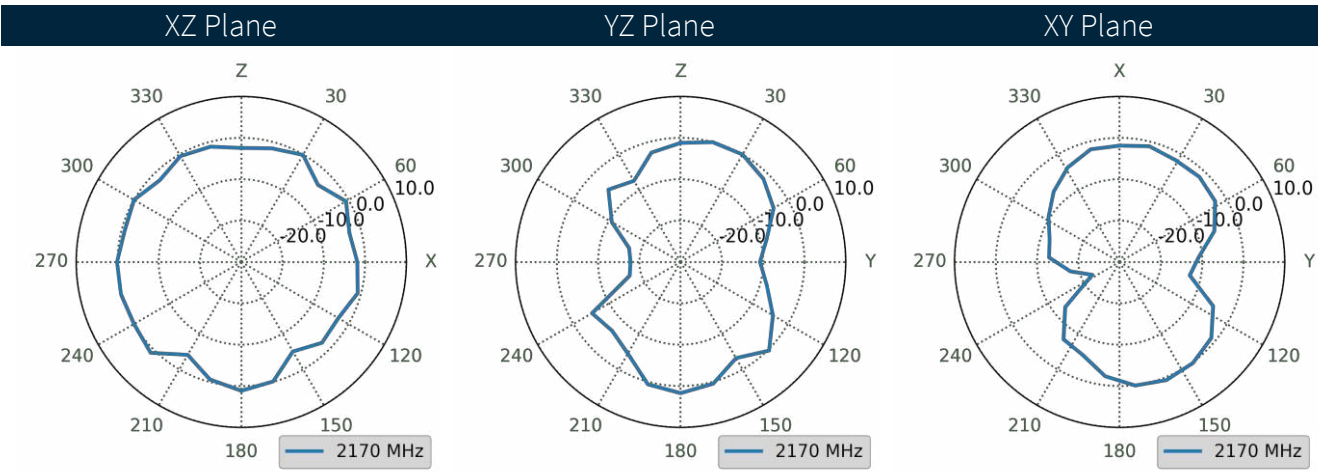
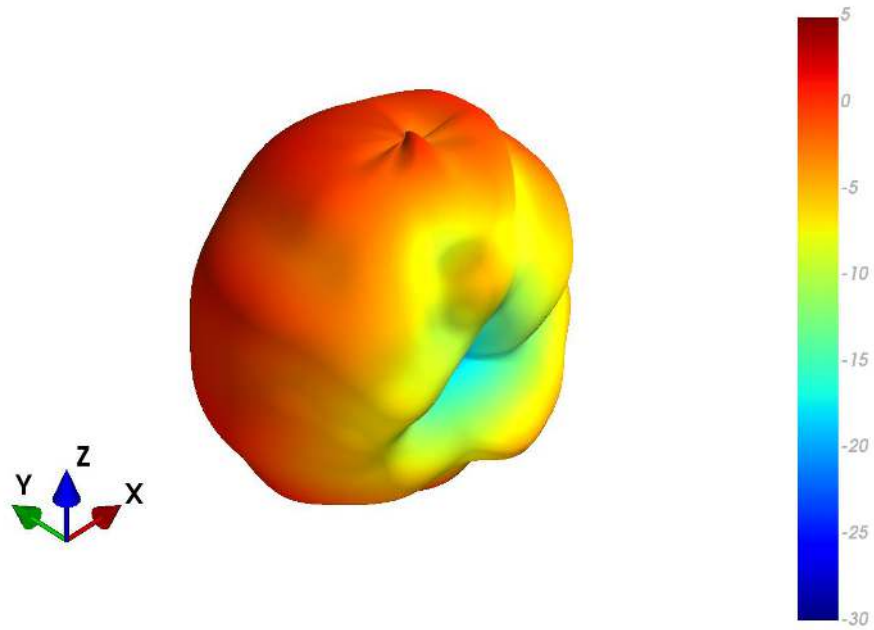

4.10 Patterns at 2500 MHz 30x30cm Ground Plane

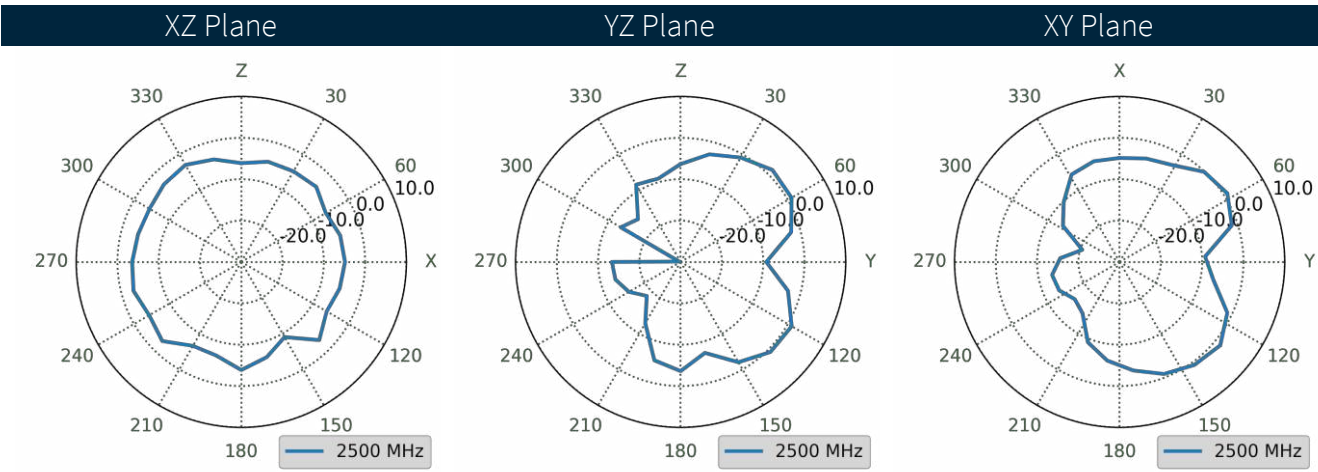
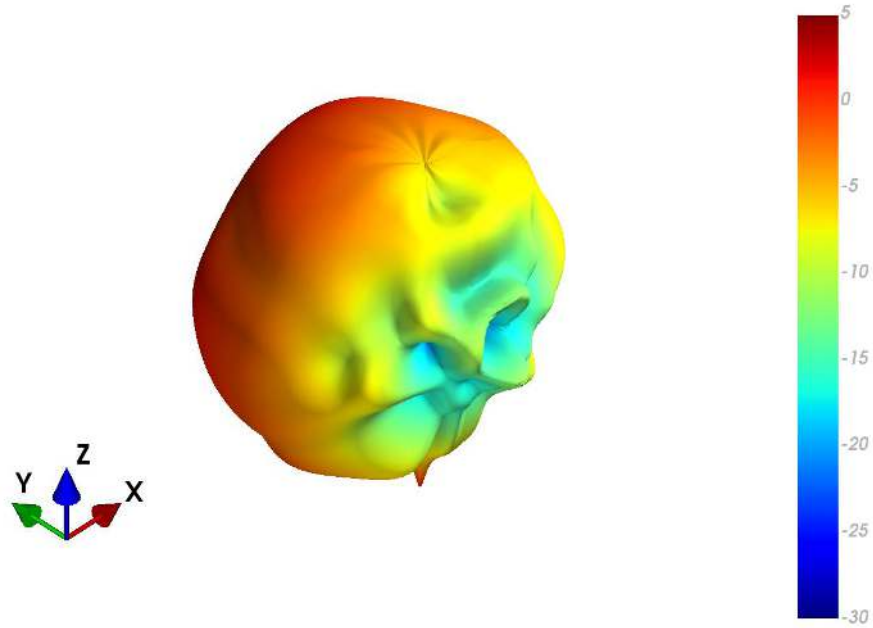

4.11 Patterns at 2500 MHz Free Space

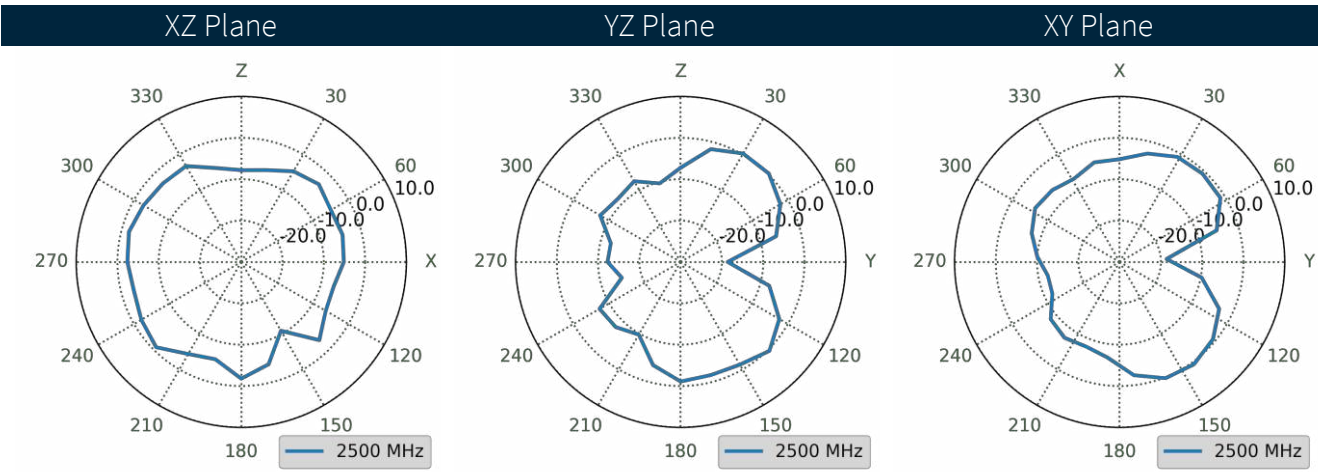
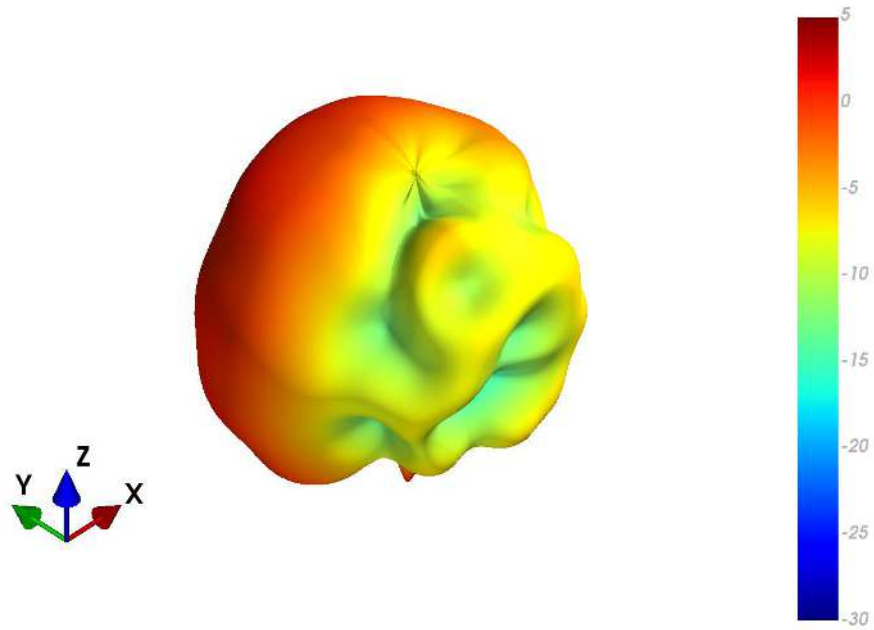

4.12 Patterns at 2690 MHz 30x30cm Ground Plane

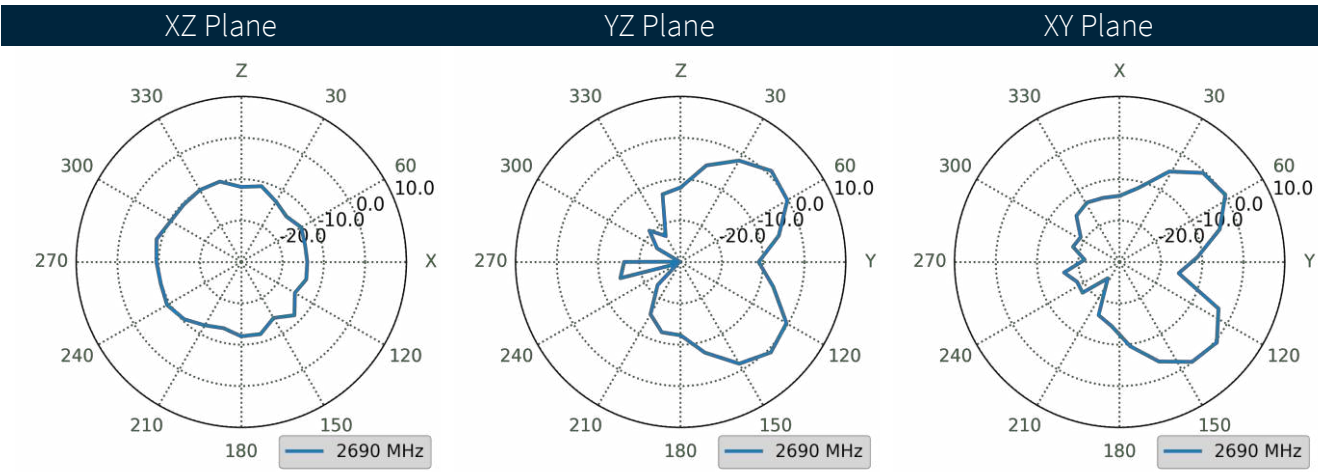
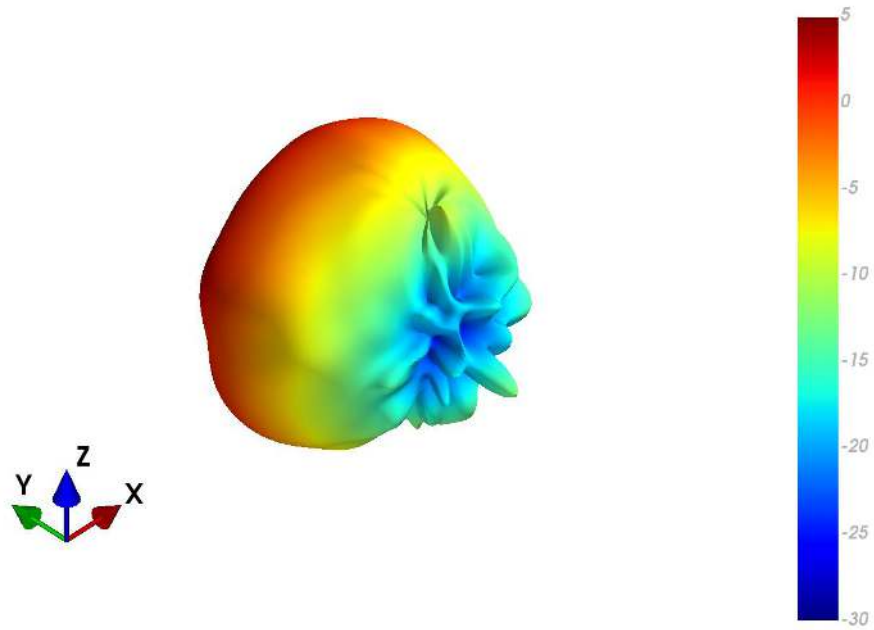

4.13 Patterns at 2690 MHz Free Space

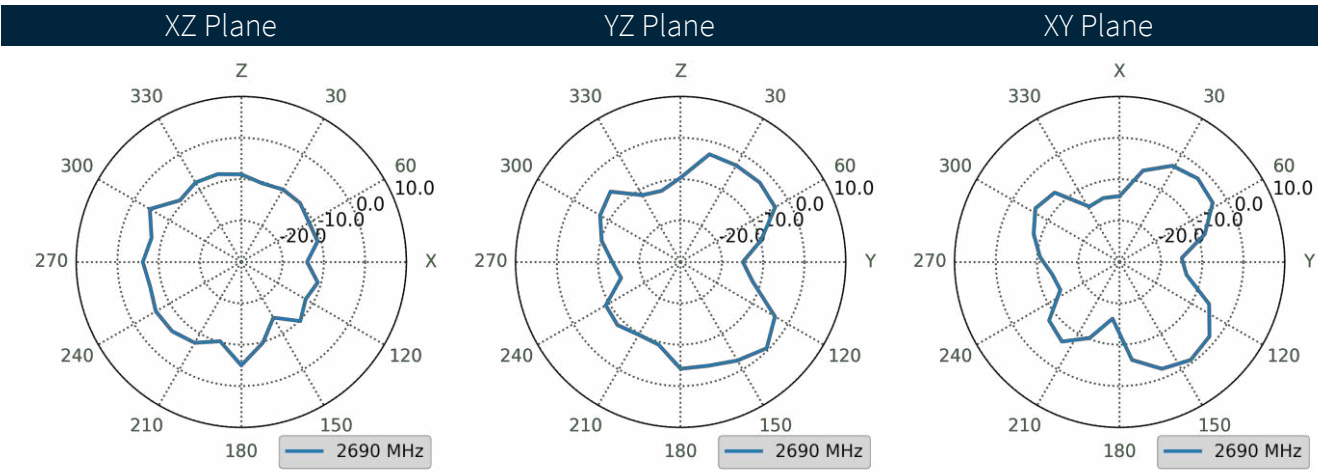
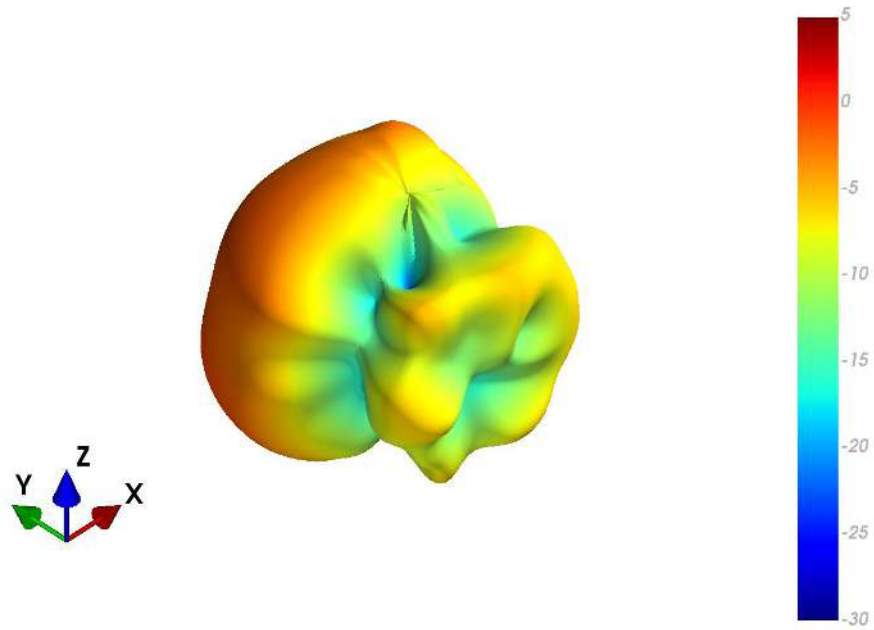

5. Mechanical Drawing (Units: mm)

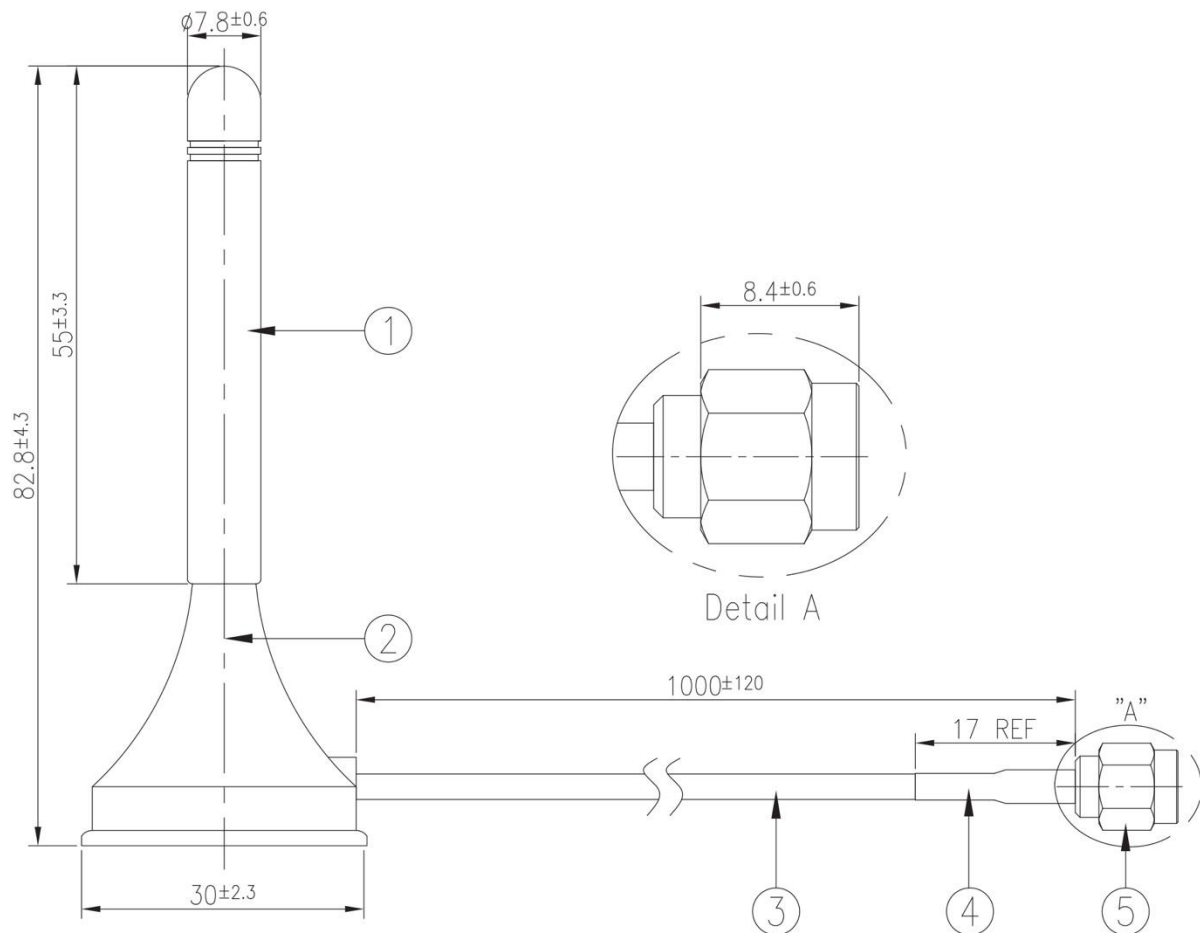

	Name	Material	Finish	QTY
1	GA.111 Antenna Housing	TPEE	Black	1
2	GA.111 Antenna Bottom	ABS	Black	1
3	RG174 Coaxial Cable	PVC	Black	1
4	Heat Shrink Tube	EVA	Black	1
5	SMA(M)ST	Brass	Au Plated	1

6. Magnetic Pull Force

Item No./Part No.	Magnetic force test Result	PASS/FAIL
Sample A(magnet type:N40)	2.8>1KGf	PASS
Sample B(magnet type:N40)	2.0>1KGf	PASS



7. Packaging

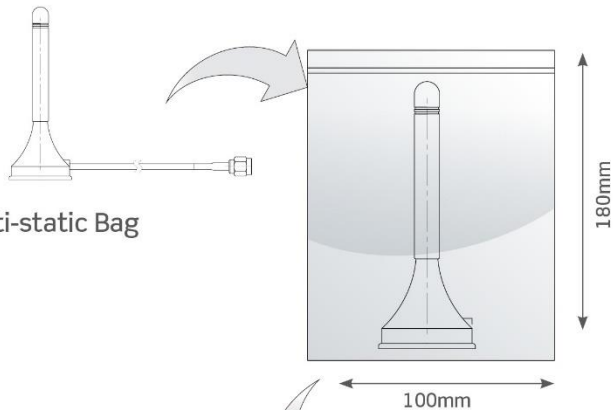

1pc GA.111.101111 in small in Anti-static Bag
 Dimensions - 100*180mm
 Weight - 32g

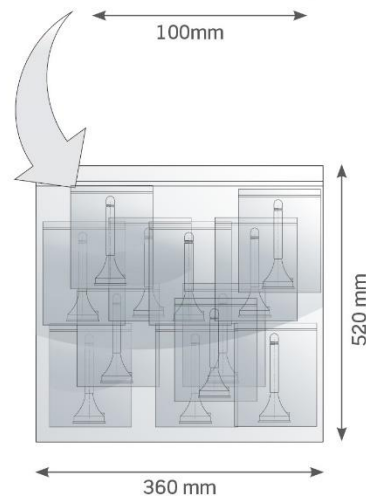

50 PE bags per large PE bags
 50 pcs GA.111.101111 per large PE bags
 Large PE bags Dimensions - 360 x 520mm
 Weight - 1.6kg

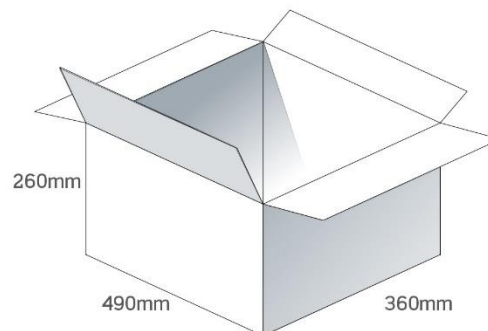

5 Large PE bags per carton
 250 pcs GA.111.101111 per carton
 Carton Dimensions - 490 x 360 x 260mm
 Weight - 8.3kg

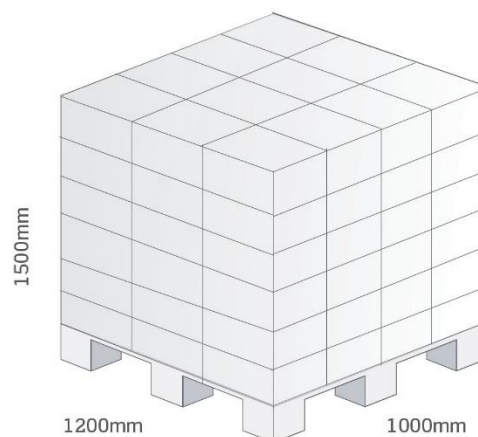

Pallet Dimensions 1200*1000*1500mm
 20 Cartons per Pallet
 4 Cartons per layer
 5 Layers

8. Application Note

The GA.111 antenna performance with different cable lengths is shown below.

8.1 Return Loss

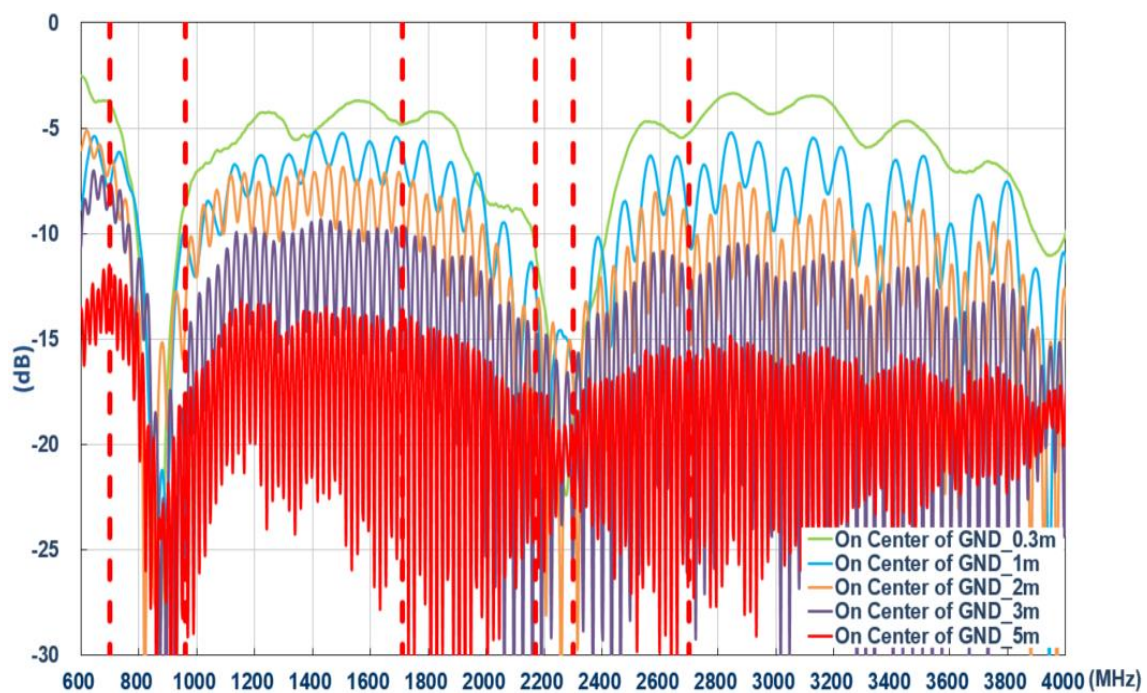
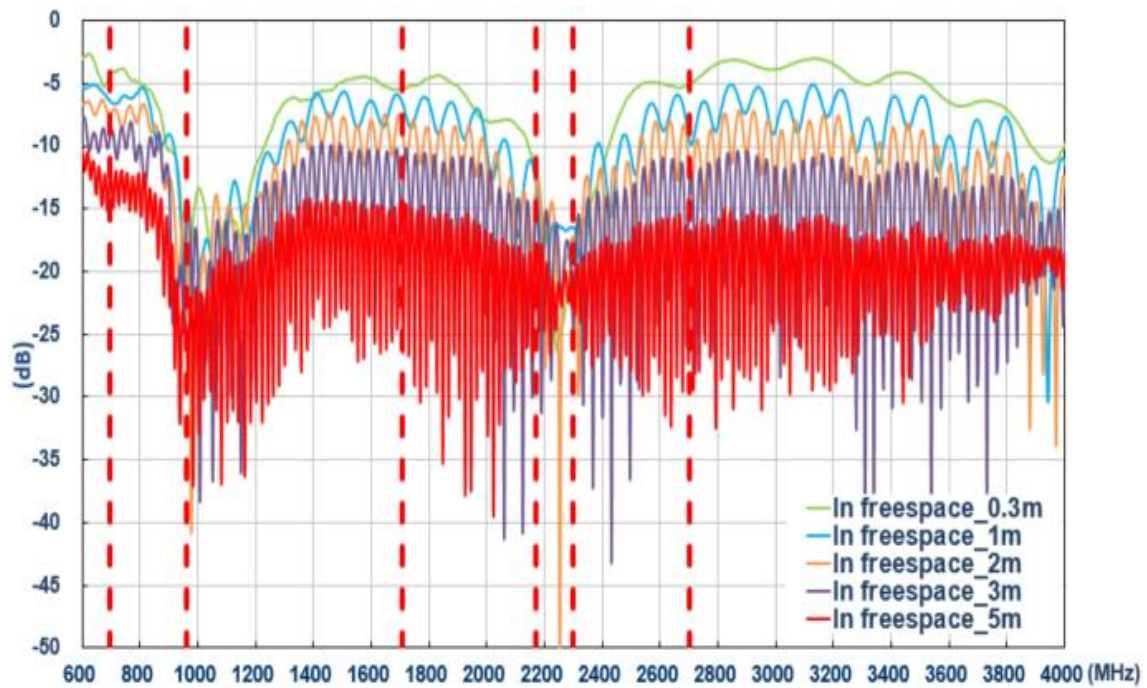

8.2 Efficiency

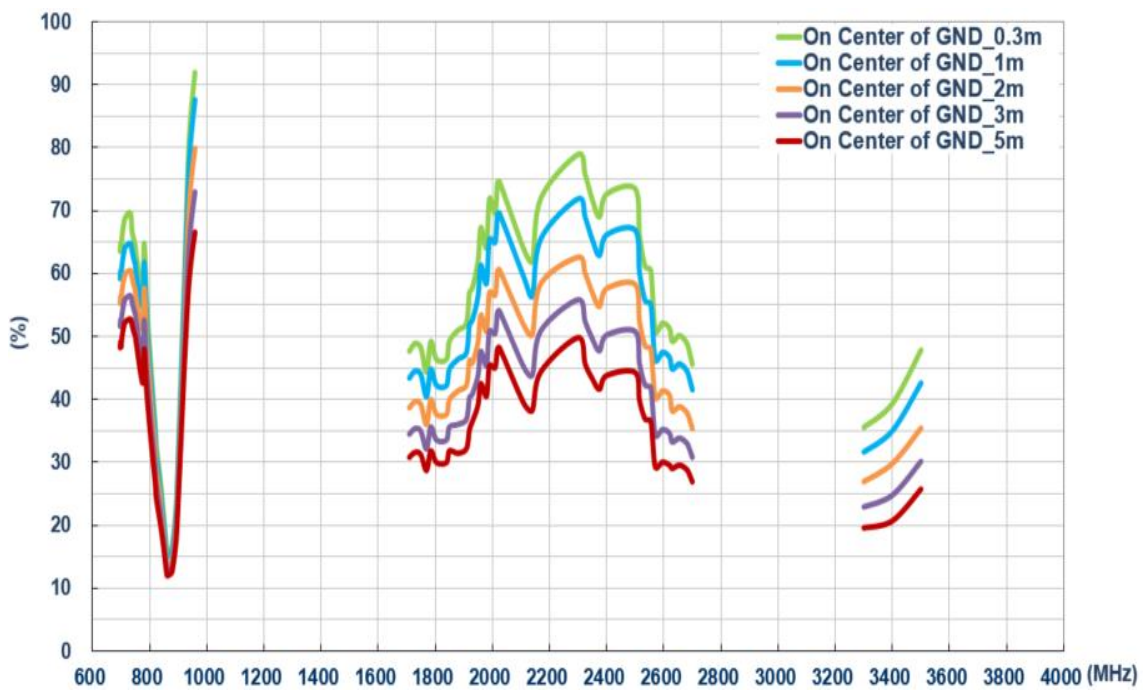
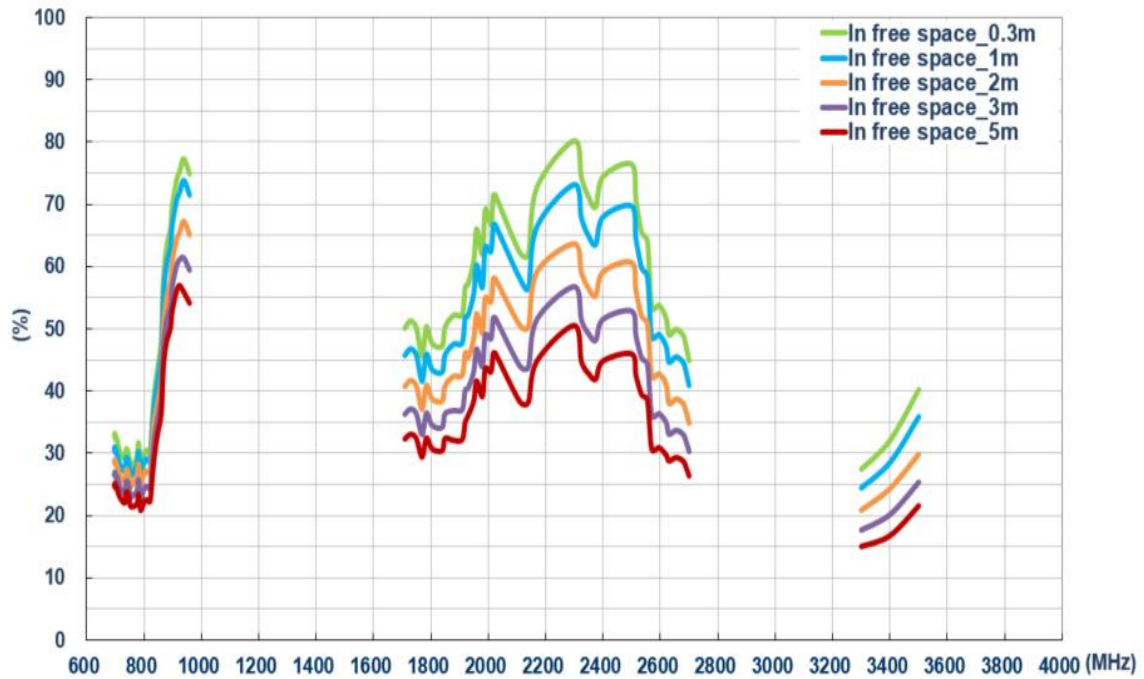

8.3 Average Gain

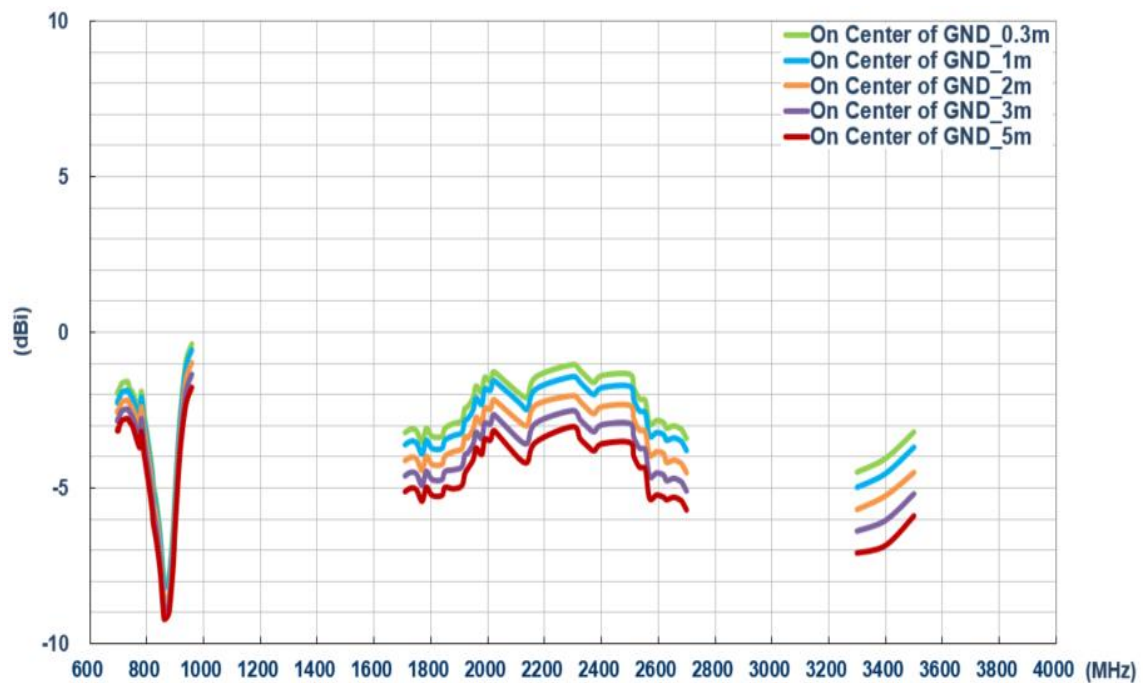
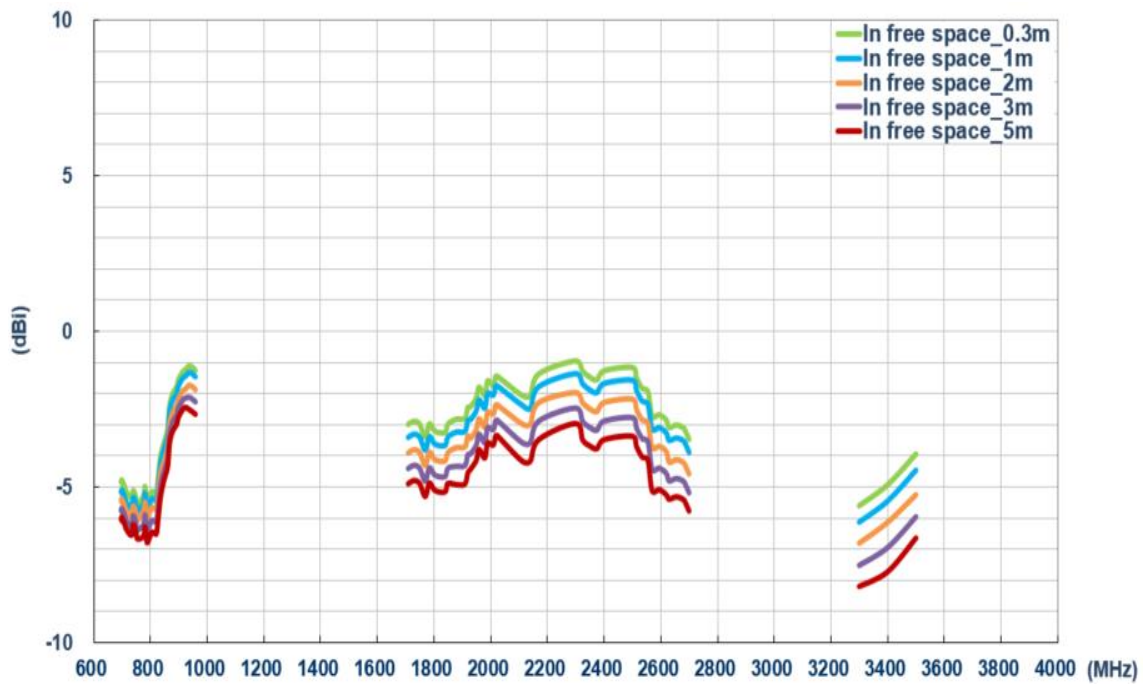

8.4 Peak Gain

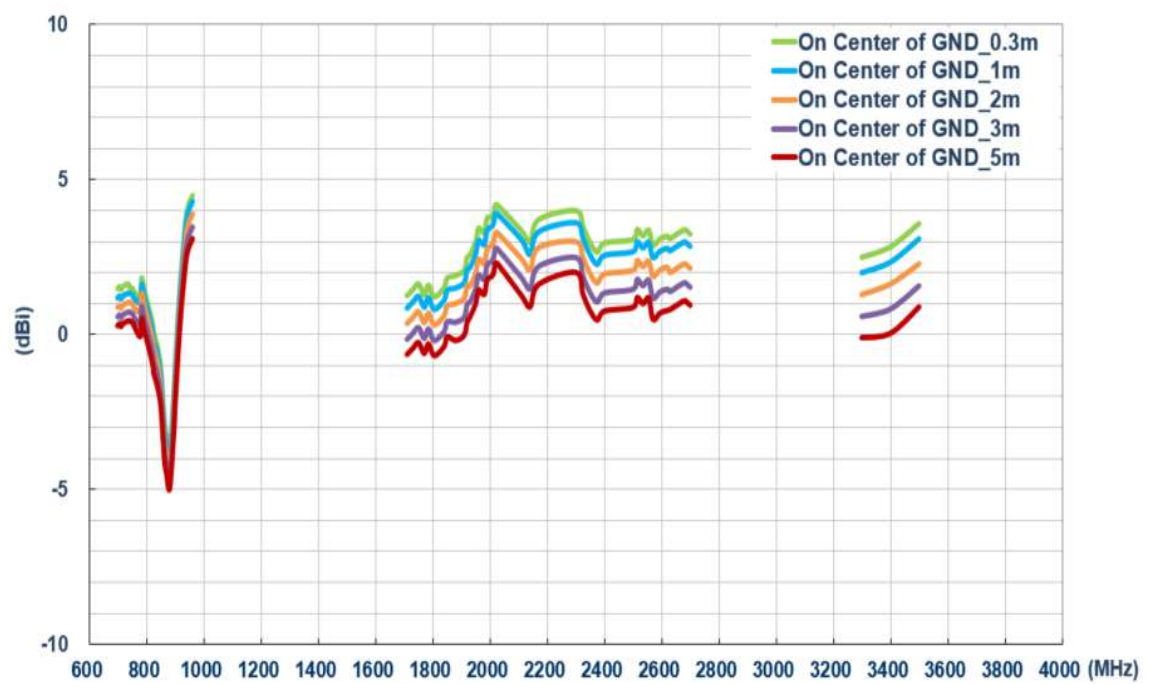
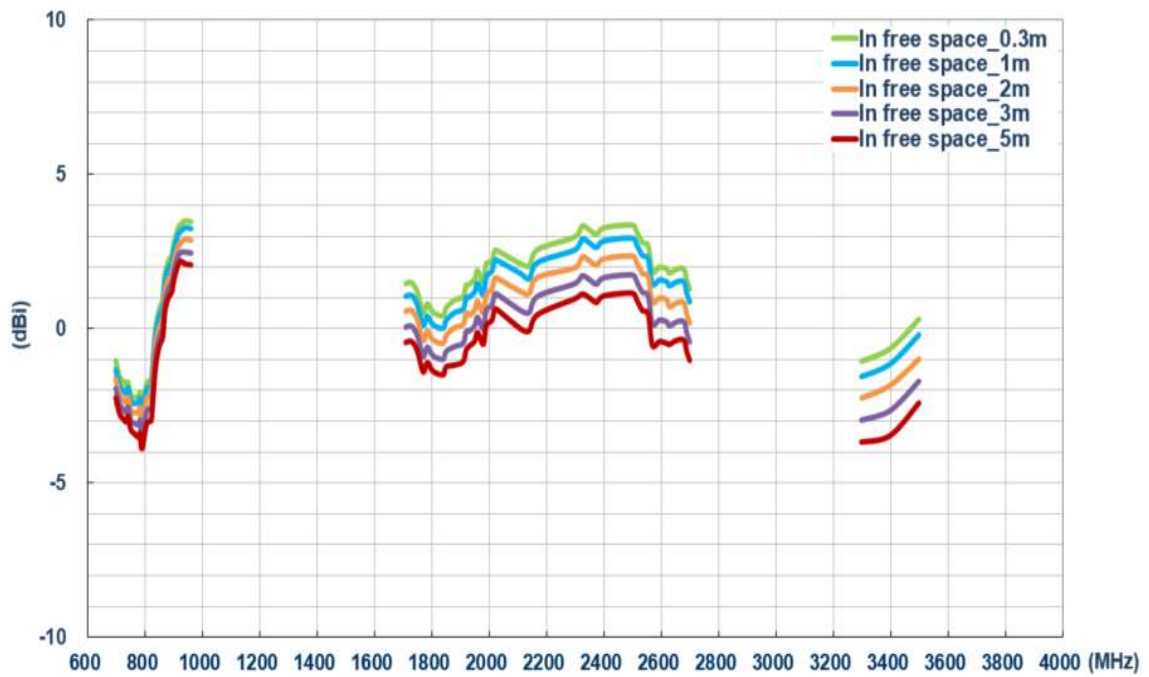

Changelog for the datasheet

SPE-17-8-092 – GA.111.101111

Revision: C (Current Version)

Date:	2023-01-30
Changes:	Updated specifications
Changes Made by:	Cesar Sousa

Previous Revisions

Revision: B

Date:	2020-05-12
Changes:	Updated Template
Changes Made by:	Jack Conroy

Revision: A (Original First Release)

Date:	2017-12-18
Notes:	
Author:	Jack Conroy



TAOGLAS®

www.taoglas.com

