

Dual IGBTMOD™ H-Series Module 50 Amperes/1200 Volts

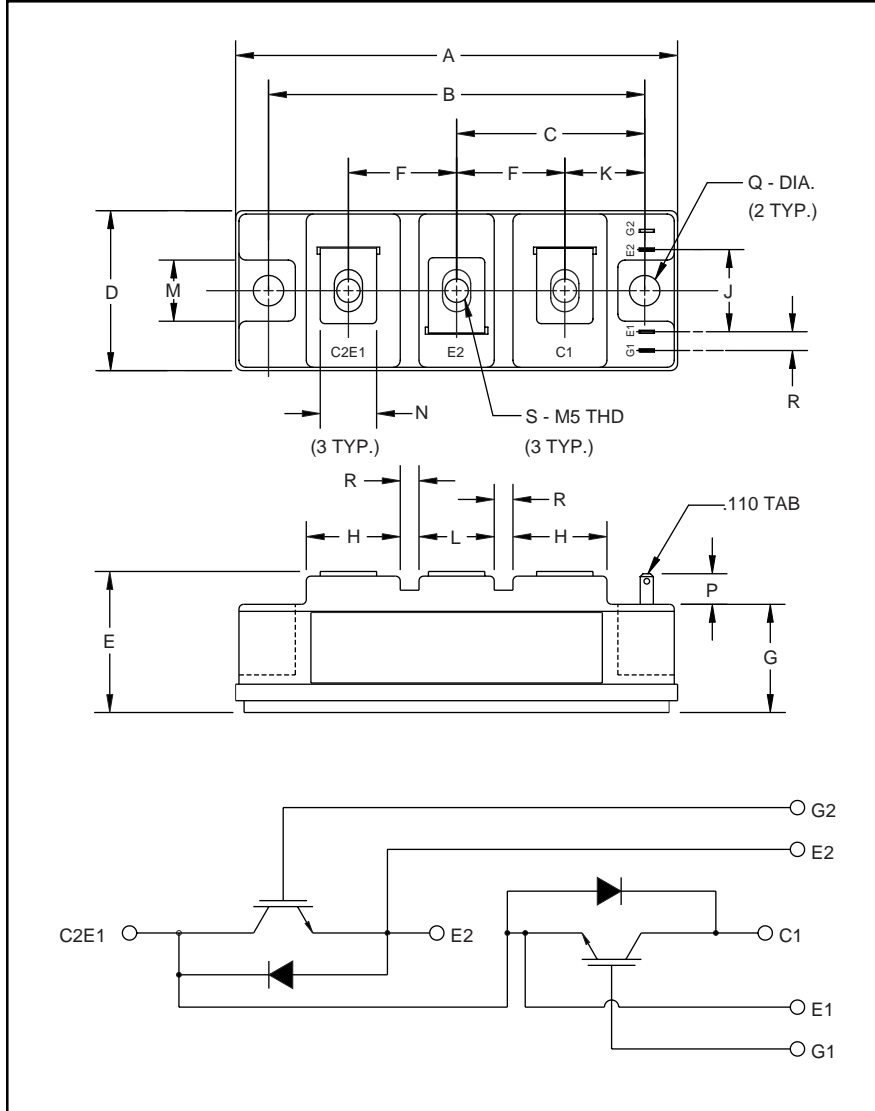

Outline Drawing and Circuit Diagram

| Dimensions | Inches | Millimeters |
|------------|------------|-------------|
| A | 3.70 | 94.0 |
| B | 3.150±0.01 | 80.0±0.25 |
| C | 1.57 | 40.0 |
| D | 1.34 | 34.0 |
| E | 1.22 Max. | 31.0 Max. |
| F | 0.90 | 23.0 |
| G | 0.85 | 21.5 |
| H | 0.79 | 20.0 |
| J | 0.71 | 18.0 |

| Dimensions | Inches | Millimeters |
|------------|------------|-------------|
| K | 0.67 | 17.0 |
| L | 0.63 | 16.0 |
| M | 0.51 | 13.0 |
| N | 0.47 | 12.0 |
| P | 0.28 | 7.0 |
| Q | 0.256 Dia. | Dia. 6.5 |
| R | 0.16 | 4.0 |
| S | M5 Metric | M5 |



Description:

Powerex IGBTMOD™ Modules are designed for use in switching applications. Each module consists of two IGBT transistors in a half-bridge configuration with each transistor having a reverse-connected super-fast recovery free-wheel diode. All components and interconnects are isolated from the heat sinking baseplate, offering simplified system assembly and thermal management.

Features:

- Low Drive Power
- Low $V_{CE(sat)}$
- Discrete Super-Fast Recovery (135ns) Free-Wheel Diode
- High Frequency Operation (20-25kHz)
- Isolated Baseplate for Easy Heat Sinking

Applications:

- AC Motor Control
- Motion/Servo Control
- UPS
- Welding Power Supplies
- Laser Power Supplies

Ordering Information:

Example: Select the complete part module number you desire from the table below -i.e. CM50DY-24H is a 1200V (V_{CES}), 50 Ampere Dual IGBTMOD™ Power Module.

| Type | Current Rating Amperes | V_{CES} Volts (x 50) |
|------|---------------------------|---------------------------|
| CM | 50 | 24 |

CM50DY-24H
Dual IGBTMOD™ H-Series Module
 50 Amperes/1200 Volts

Absolute Maximum Ratings, $T_j = 25\text{ }^\circ\text{C}$ unless otherwise specified

| Ratings | Symbol | CM50DY-24H | Units |
|---|-----------|------------|------------------|
| Junction Temperature | T_j | -40 to 150 | $^\circ\text{C}$ |
| Storage Temperature | T_{stg} | -40 to 125 | $^\circ\text{C}$ |
| Collector-Emitter Voltage (G-E SHORT) | V_{CES} | 1200 | Volts |
| Gate-Emitter Voltage | V_{GES} | ± 20 | Volts |
| Collector Current | I_C | 50 | Amperes |
| Peak Collector Current | I_{CM} | 100* | Amperes |
| Diode Forward Current | I_F | 50 | Amperes |
| Diode Forward Surge Current | I_{FM} | 100* | Amperes |
| Power Dissipation | P_d | 400 | Watts |
| Max. Mounting Torque M5 Terminal Screws | - | 17 | in-lb |
| Max. Mounting Torque M6 Mounting Screws | - | 26 | in-lb |
| Module Weight (Typical) | - | 190 | Grams |
| V Isolation | V_{RMS} | 2500 | Volts |

* Pulse width and repetition rate should be such that device junction temperature does not exceed the device rating.

Static Electrical Characteristics, $T_j = 25\text{ }^\circ\text{C}$ unless otherwise specified

| Characteristics | Symbol | Test Conditions | Min. | Typ. | Max. | Units |
|--------------------------------------|---------------|---|------|------|-------|---------------|
| Collector-Cutoff Current | I_{CES} | $V_{CE} = V_{CES}, V_{GE} = 0V$ | - | - | 1.0 | mA |
| Gate Leakage Current | I_{GES} | $V_{GE} = V_{GES}, V_{CE} = 0V$ | - | - | 0.5 | μA |
| Gate-Emitter Threshold Voltage | $V_{GE(th)}$ | $I_C = 5\text{mA}, V_{CE} = 10V$ | 4.5 | 6.0 | 7.5 | Volts |
| Collector-Emitter Saturation Voltage | $V_{CE(sat)}$ | $I_C = 50\text{A}, V_{GE} = 15V$ | - | 2.5 | 3.4** | Volts |
| | | $I_C = 50\text{A}, V_{GE} = 15V, T_j = 150^\circ\text{C}$ | - | 2.25 | - | Volts |
| Total Gate Charge | Q_G | $V_{CC} = 600V, I_C = 50\text{A}, V_{GS} = 15V$ | - | 250 | - | nC |
| Diode Forward Voltage | V_{FM} | $I_E = 50\text{A}, V_{GS} = 0V$ | - | - | 3.5 | Volts |

** Pulse width and repetition rate should be such that device junction temperature rise is negligible.

Dynamic Electrical Characteristics, $T_j = 25\text{ }^\circ\text{C}$ unless otherwise specified

| Characteristics | Symbol | Test Conditions | Min. | Typ. | Max. | Units |
|-------------------------------|---------------------|--|------|------|------|---------------|
| Input Capacitance | C_{ies} | | - | - | 10 | nF |
| Output Capacitance | C_{oes} | $V_{GE} = 0V, V_{CE} = 10V, f = 1\text{MHz}$ | - | - | 3.5 | nF |
| Reverse Transfer Capacitance | C_{res} | | - | - | 2 | nF |
| Resistive | Turn-on Delay Time | $V_{CC} = 600V, I_C = 50\text{A},$ | - | - | 80 | ns |
| Load | Rise Time | | | | | |
| Switching | Turn-off Delay Time | $V_{GE1} = V_{GE2} = 15V, R_G = 6.3\Omega$ | - | - | 150 | ns |
| | Times | | | | | |
| Diode Reverse Recovery Time | t_{rr} | $I_E = 50\text{A}, di_E/dt = -100\text{A}/\mu\text{s}$ | - | - | 250 | ns |
| Diode Reverse Recovery Charge | Q_{rr} | $I_E = 50\text{A}, di_E/dt = -100\text{A}/\mu\text{s}$ | - | 0.37 | - | μC |

Thermal and Mechanical Characteristics, $T_j = 25\text{ }^\circ\text{C}$ unless otherwise specified

| Characteristics | Symbol | Test Conditions | Min. | Typ. | Max. | Units |
|--------------------------------------|---------------|------------------------------------|------|------|-------|---------------------------|
| Thermal Resistance, Junction to Case | $R_{th(j-c)}$ | Per IGBT | - | - | 0.31 | $^\circ\text{C}/\text{W}$ |
| Thermal Resistance, Junction to Case | $R_{th(j-c)}$ | Per FWDi | - | - | 0.70 | $^\circ\text{C}/\text{W}$ |
| Contact Thermal Resistance | $R_{th(c-f)}$ | Per Module, Thermal Grease Applied | - | - | 0.075 | $^\circ\text{C}/\text{W}$ |



Powerex, Inc., 200 Hillis Street, Youngwood, Pennsylvania 15697-1800 (724) 925-7272

CM50DY-24H
Dual IGBTMOD™ H-Series Module
 50 Amperes/1200 Volts

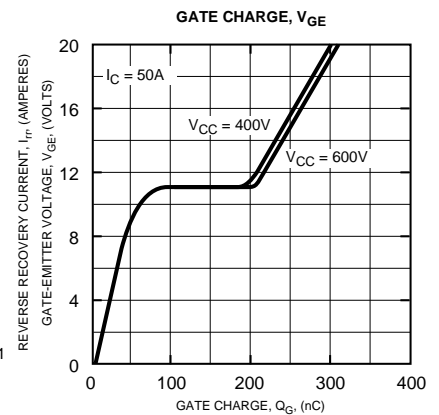
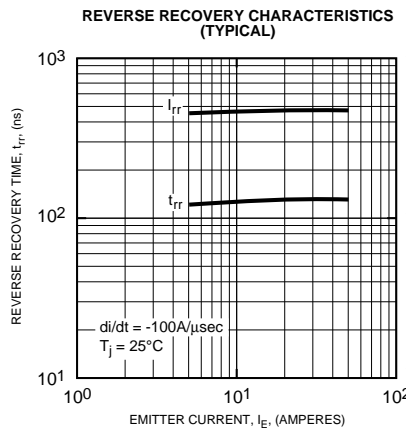
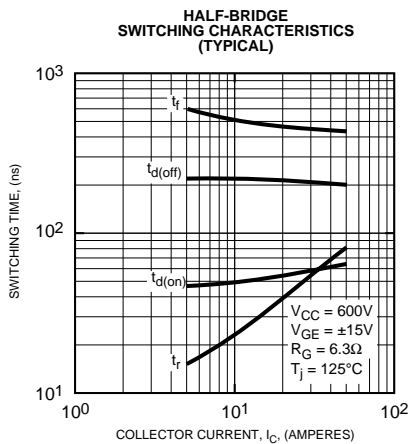
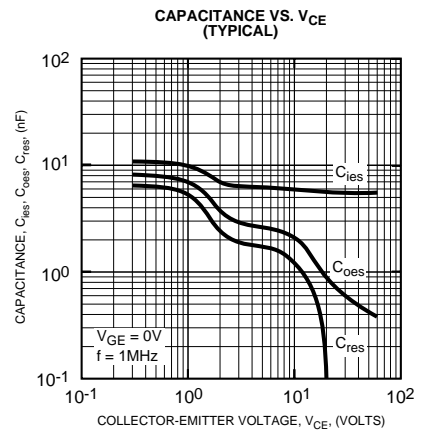
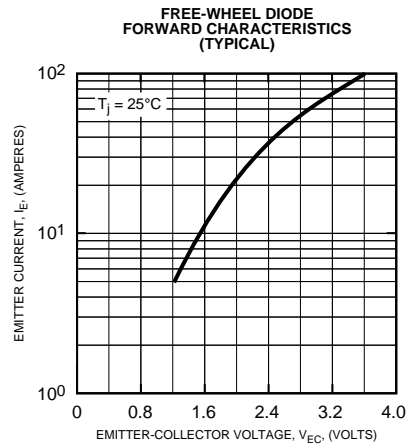
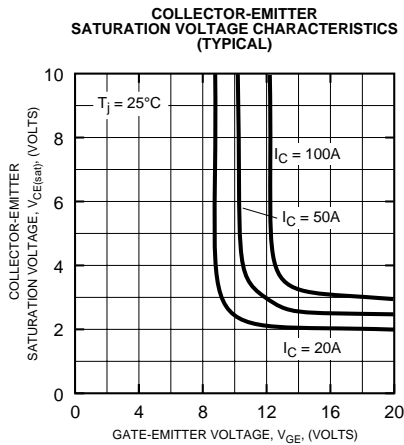
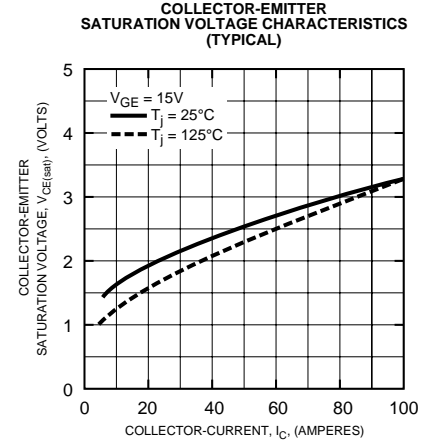
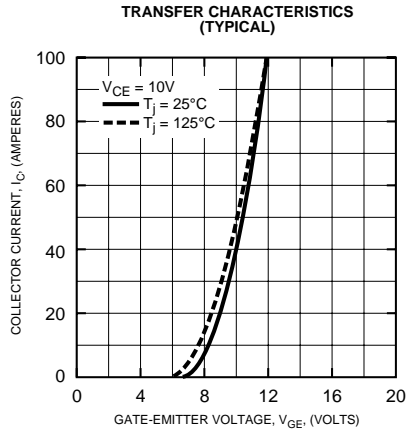
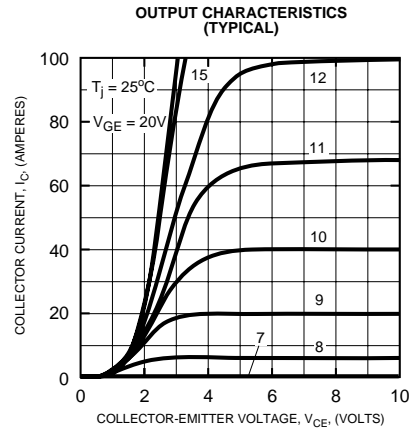

CM50DY-24H
Dual IGBTMOD™ H-Series Module
 50 Amperes/1200 Volts

