

ISL99201

Filterless High Efficiency 1.5W Class D Mono Amplifier

FN6742
 Rev 2.00
 November 1, 2013

The ISL99201 is a fully integrated high efficiency class-D mono amplifier. It is designed to maximize performance for mobile phone applications. The application circuit requires a minimum requirement of external components and operates from a 2.4V to 5.5V input supply. It is capable of delivering 1.4W of continuous output power with less than 1% THD+N driving a 8Ω load from a 5V supply.

The ISL99201 features a high-efficiency, low-noise modulation scheme. It operates with 86% efficiency at 400mW into 8Ω and has a signal-to-noise ratio (SNR) that is better than 95dB. The ISL99201 has a micro-power shutdown mode with a typical shutdown current of 200nA. Shutdown is enabled by applying a logic low to the \overline{SD} pin.

The architecture of the devices allows it to achieve very low level of pop-and-click. This minimizes voltage glitches at the output during turn-on and turn-off, thus reducing audible noise on activation and deactivation.

The fully differential input of the ISL99201 provides excellent rejection of common mode noise on the input typically 75dB. EMI suppression is achieved by SRC (Slew Rate Control).

The ISL99201 oscillator can be synchronized to an external clock through the SYNC input, allowing the switching frequency to be externally defined. The SYNC input also allows multiple ISL99201 to be cascaded and frequency locked; minimizing interference due to clock intermodulation.

The ISL99201 also has excellent rejection of power supply noise, including noise caused by GSM transmission bursts and RF rectification. PSRR is typically 75dB at 217Hz. There will be 4 versions of the part; they will consist of three fixed gain settings (6dB, 9.6dB, 12dB) and one user programmable gain setting (need external resistors).

The ISL99201 has built-in thermal shutdown and output short-circuit protection.

Features

- Filterless class D with efficiency > 86% at 400mW
- Click-pop suppression
- Slew rate control
- Spread spectrum switching
- Optional SYNC pin for master/slave operation without interface
- 1.4W into 8Ω with less than 1% THD+N
- 2.4V to 5.5V single supply voltage
- Built-in resistors to reduce board component count
- Only one external component required (Fixed gain mode)
- Short circuit and thermal protection
- Gain programmable 6dB, 9.6dB, 12dB and User programmable
- Pb-Free (RoHS compliant)

Applications

- Mobile phones
- MP3 players
- Portable gaming
- Portable electronics
- Educational toys

Ordering Information

| PART NUMBER | PART MARKING | GAIN SETTING (dB) | TEMP. RANGE (°C) | PACKAGE Tape and Reel (Pb-Free) | PKG. DWG. # |
|-------------------------------|------------------|-------------------|------------------|---------------------------------------|----------------|
| ISL99201IRTAZ-T (Notes 1, 2) | 201A | 6 | -40 to +85 | 8 Ld 3x3 TDFN | L8.3x3A |
| ISL99201IRTAZ-TK (Notes 1, 2) | 201A | 6 | -40 to +85 | 8 Ld 3x3 TDFN | L8.3x3A |
| ISL99201IRTBZ-T (Notes 1, 2) | 201B | 9.6 | -40 to +85 | 8 Ld 3x3 TDFN | L8.3x3A |
| ISL99201IRTBZ-TK (Notes 1, 2) | 201B | 9.6 | -40 to +85 | 8 Ld 3x3 TDFN | L8.3x3A |
| ISL99201IRTCZ-T (Notes 1, 2) | 201C | 12 | -40 to +85 | 8 Ld 3x3 TDFN | L8.3x3A |
| ISL99201IRTCZ-TK (Notes 1, 2) | 201C | 12 | -40 to +85 | 8 Ld 3x3 TDFN | L8.3x3A |
| ISL99201IRTDZ-T (Notes 1, 2) | 201D | Prog. | -40 to +85 | 8 Ld 3x3 TDFN | L8.3x3A |
| ISL99201IRTDZ-TK (Notes 1, 2) | 201D | Prog. | -40 to +85 | 8 Ld 3x3 TDFN | L8.3x3A |
| ISL99201IRTAEVZ | Evaluation Board | | | | |
| ISL99201IRTBVZ | Evaluation Board | | | | |
| ISL99201IRTCVZ | Evaluation Board | | | | |
| ISL99201IRTDVZ | Evaluation Board | | | | |

NOTES:

- Please refer to [TB347](#) for details on reel specifications.
- These Intersil Pb-free plastic packaged products employ special Pb-free material sets, molding compounds/die attach materials, and 100% matte tin plate plus anneal (e3 termination finish, which is RoHS compliant and compatible with both SnPb and Pb-free soldering operations). Intersil Pb-free products are MSL classified at Pb-free peak reflow temperatures that meet or exceed the Pb-free requirements of IPC/JEDEC J STD-20.

Pinout

ISL99201
(8 LD TDFN)
TOP VIEW

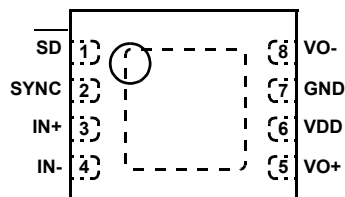

Absolute Maximum Ratings (Reference to GND)

Supply Voltage -0.3V to 6V
 Input Voltage -0.3V to $V_{DD}+0.3V$

Recommended Operating Conditions

Ambient Temperature Range -40°C to +85°C
 Operating Supply Voltage (V_{DD} Pin) 2.4V to 5.5V

Thermal Information

Thermal Resistance (Typical Note 3) θ_{JA} (°C/W)
 TDFN Package 53
 Maximum Junction Temperature (Plastic Package) -65°C to +150°C
 Maximum Storage Temperature Range -65°C to +150°C
 Power Dissipation Ratings
 8 Ld 3x3 TDFN
 Derating Factor 21.8mW/°C
 Power Ratings
 $T_A = +25^\circ\text{C}$ 2.7W
 $T_A = +70^\circ\text{C}$ 1.7W
 $T_A = +85^\circ\text{C}$ 1.4W
 Pb-Free Reflow Profile see link below
<http://www.intersil.com/pbfree/Pb-FreeReflow.asp>

CAUTION: Do not operate at or near the maximum ratings listed for extended periods of time. Exposure to such conditions may adversely impact product reliability and result in failures not covered by warranty.

NOTE:

3. θ_{JA} is measured in free air with the component mounted on a high effective thermal conductivity test board with "direct attach" features. See Tech Brief [TB379](#)

Electrical Specifications Typical Values Are Tested at $V_{DD} = 5V$ and the Ambient Temperature at +25°C.

| PARAMETER | SYMBOL | TEST CONDITIONS | MIN (Note 5) | TYP | MAX (Note 5) | UNITS |
|------------------------------------|---------------------------------|---|-----------------|------|-----------------|-------|
| Output Power | P_O | $R_L = 8\Omega$, THD = 10%, $f = 1\text{kHz}$, 20kHz BW, $V_{DD} = 5.0V$ | | 1.4 | | W |
| | | $R_L = 8\Omega$, THD = 10%, $f = 1\text{kHz}$, 20kHz BW, $V_{DD} = 3.6V$ | | 0.75 | | W |
| | | $R_L = 8\Omega$, THD = 10%, $f = 1\text{kHz}$, 20kHz BW, $V_{DD} = 2.5V$ | | 0.4 | | W |
| | | $R_L = 8\Omega$, THD = 1%, $f = 1\text{kHz}$, 20kHz BW, $V_{DD} = 5.0V$ | | 1.15 | | W |
| Efficiency | η | $P_{OUT} = 1.4W$, $8\Omega + 33\mu\text{H}$, $V_{DD} = 5.0V$ | | 90 | | % |
| Total Harmonic Distortion + Ratio | THD+N | $P_O = 1W$ into 8Ω each channel, $f = 1\text{kHz}$, $V_{DD} = 5.0V$ | | 0.05 | | % |
| | | $P_O = 0.5W$ into 8Ω each channel, $f = 1\text{kHz}$, $V_{DD} = 3.6V$ | | 0.05 | | % |
| | | $P_O = 0.2W$ into 8Ω each channel, $f = 1\text{kHz}$, $V_{DD} = 3.6V$ | | 0.09 | | % |
| Common-Mode Rejection Ratio | CMRR | $V_{IC} = 0.5V$ to $(V_{DD} - 0.8V)$; $R_L = 8\Omega$, $V_{DD} = 2.5V$ to $5.5V$ | | -60 | | dB |
| | CMRR _{GSM} | $V_{CM} = 2.5V \pm 1V_{P-P}$ at 217Hz, $R_L = 8\Omega$ | | -60 | | dB |
| Average Switching Frequency | f_{sw} | $V_{DD} = 5V$ | 300 | 375 | 450 | kHz |
| Differential Output Offset Voltage | V_{OOS} | $G = 6\text{dB}$; 9.6dB ; 12dB ; 28dB . | | 0.2 | 5.0 | mV |
| POWER SUPPLY | | | | | | |
| Supply Voltage Range | V_{DD} | | 2.4 | | 5.5 | V |
| Power Supply Rejection Ratio | PSRR | $V_{DD} = 2.5V$ to $5.0V$ | | -65 | | dB |
| | PSRR _{GSM} | $V_{RIPPLT} = 100\text{mV}_{RMS}$ at 217Hz (Input AC-Coupled with $2\mu\text{F}$ capacitor) | | -65 | | dB |
| Supply Current | I_{IN} | $V_{IN} = 0V$, No load, $V_{DD} = 5V$ | | 3.9 | | mA |
| | | $V_{IN} = 0V$, No load, $V_{DD} = 3.6V$ | | 3.2 | 3.75 | mA |
| | | $V_{IN} = 0V$, $8\Omega + 33\mu\text{H}$, $V_{DD} = 5V$ | | 3.9 | | mA |
| | | $V_{IN} = 0V$, $8\Omega + 33\mu\text{H}$, $V_{DD} = 3.6V$ | | 3.8 | | mA |
| | $\overline{I_{SD}}$ (Note 4) | $\overline{SD} = \text{GND}$ | | | 0.2 | 0.4 |

Electrical Specifications Typical Values Are Tested at $V_{DD} = 5V$ and the Ambient Temperature at $+25^{\circ}C$. (Continued)

| PARAMETER | SYMBOL | TEST CONDITIONS | MIN (Note 5) | TYP | MAX (Note 5) | UNITS |
|------------------------------|-----------|--|-----------------|-------|-----------------|-----------|
| GAIN CONTROL | | | | | | |
| Closed-Loop Gain | | D version user program (Max Gain, $R_i = 0\Omega$) | 27.5 | 28.5 | 29.5 | dB |
| | | A version | 5.7 | 6 | 6.3 | dB |
| | | B version | 9.2 | 9.6 | 10 | dB |
| | | C version | 11.5 | 12 | 12.5 | dB |
| Differential Input Impedance | Z_{IN} | $\overline{SD} = V_{DD}$, A version | | 70 | | $k\Omega$ |
| | | $\overline{SD} = V_{DD}$, B version | | 46.25 | | $k\Omega$ |
| | | $\overline{SD} = V_{DD}$, C version | | 35 | | $k\Omega$ |
| | | $\overline{SD} = V_{DD}$, D version, $R_i = 2.5k\Omega$ | | 7.5 | | $k\Omega$ |
| | | $\overline{SD} = GND$ | | 100 | | $k\Omega$ |
| SHUTDOWN CONTROL | | | | | | |
| Input Voltage High | V_{IH} | | | 1.2 | | V |
| Input Voltage Low | V_{IL} | | | 0.5 | | V |
| Turn-on Time | t_{WU} | \overline{SD} rising edge from GND to V_{DD} | | 3.5 | | ms |
| Turn-off Time | t_{SD} | \overline{SD} falling edge from V_{DD} to GND | | 5 | | μs |
| Output Impedance | Z_{OUT} | $\overline{SD} = GND$ | | >100 | | $k\Omega$ |
| NOISE PERFORMANCE | | | | | | |
| Output Voltage Noise | E_n | $V_{DD} = 3.6V$, $f = 20Hz$ to $20kHz$, inputs are AC grounded, $A_v = 6dB$, A-weighting | | 27 | | μV |
| | | $V_{DD} = 3.6V$, $f = 20Hz$ to $20kHz$, inputs are AC grounded, $A_{v0} = 6dB$, no weighting | | 35 | | μV |
| Signal-to-Noise Ratio | SNR | $P_{OUT} = 1W$, $R_L = 8\Omega$ | | 102 | | dB |

NOTES:

- Limits established by Characterization and are not production tested
- Parameters with MIN and/or MAX limits are 100% tested at $+25^{\circ}C$, unless otherwise specified. Temperature limits established by characterization and are not production tested.

Pin Descriptions

SD

Shutdown Active Low. This signal is used to shut down and activate the part. It is 1.8V to 5V compatible. During shutdown, the part draws less than 100nA input current. Coming out of shutdown takes 3.5ms and going into shutdown is instantaneous.

SYNC

External clock input. This pin allows the chip to be synchronized to a system clock. This helps in folding the spectral components and the switching harmonic out of band of interest. The range of SYNC frequency is from 250kHz to 800kHz.

IN+

Positive Differential Input.

IN-

Negative Differential Input.

VO+

Positive BTL output.

GND

Ground.

VDD

Power Supply.

VO-

Negative BTL output.

Block Diagram (Notes)

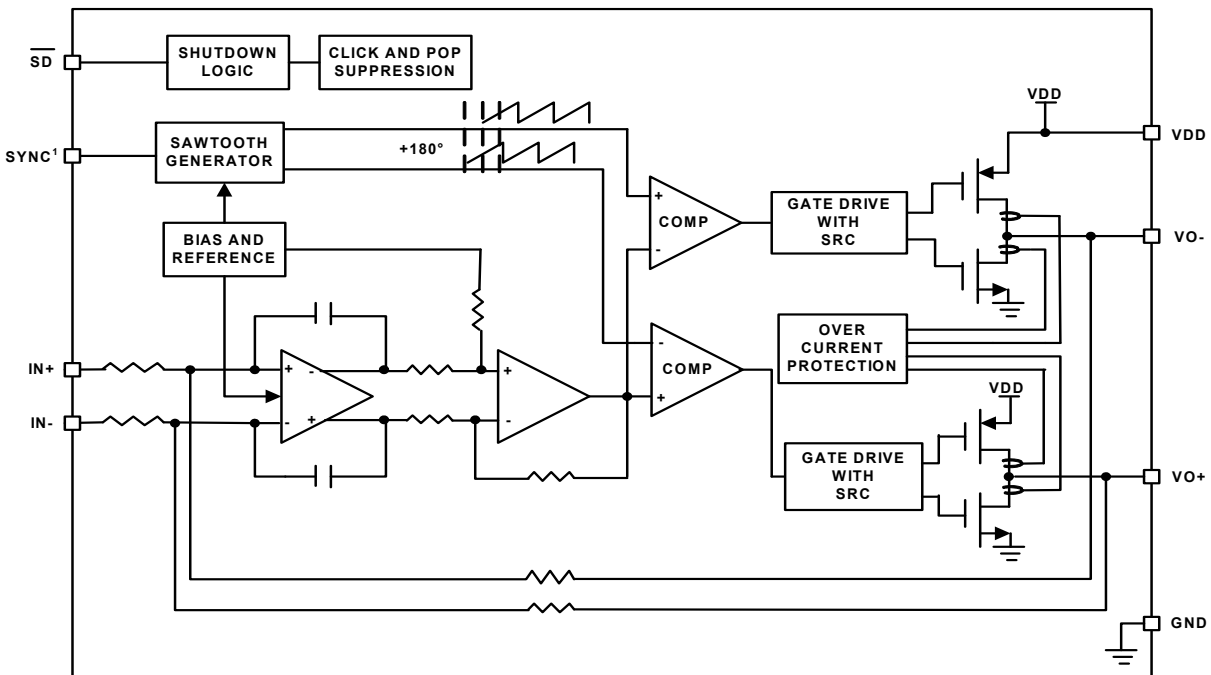

Notes:

Gain = 6dB, 9.6dB, 12dB (gain setting)

$$\text{Gain} = \frac{140\text{k}\Omega}{(R_i + 5\text{k}\Omega)}; \text{ with external resistor}$$

Typical Performance Characteristics

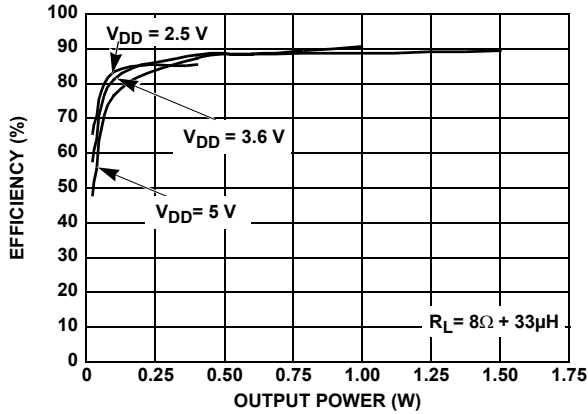

FIGURE 1. EFFICIENCY vs OUTPUT POWER

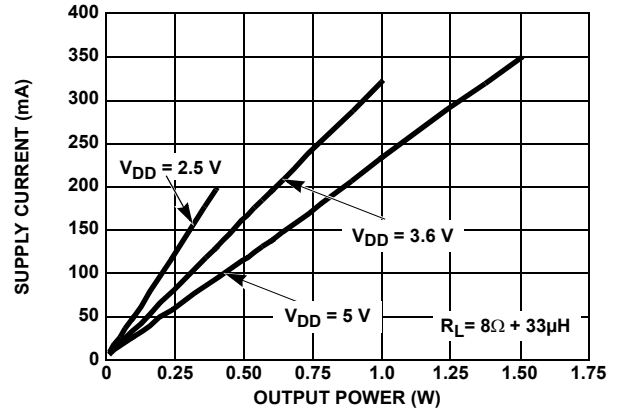

FIGURE 2. SUPPLY CURRENT vs OUTPUT POWER

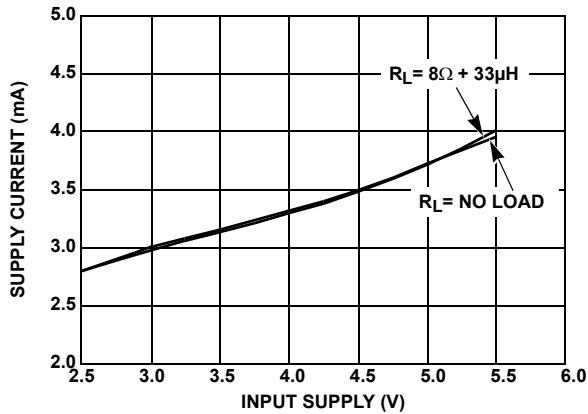

FIGURE 3. SUPPLY CURRENT vs SUPPLY VOLTAGE

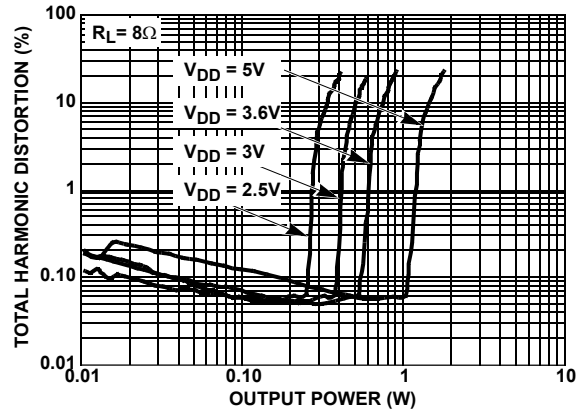

FIGURE 4. TOTAL HARMONIC DISTORTION + NOISE vs OUTPUT POWER

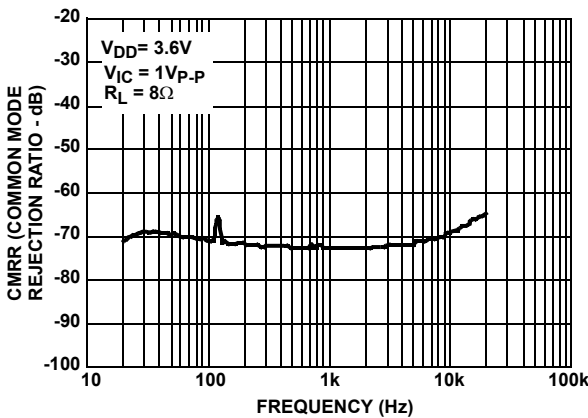

FIGURE 5. COMMON MODE REJECTION MODE vs FREQUENCY

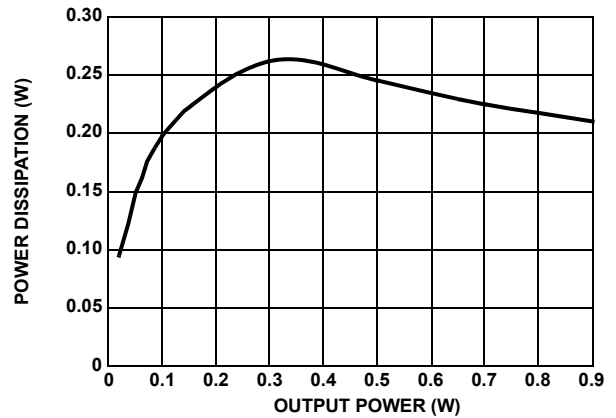

FIGURE 6. POWER DISSIPATION vs OUTPUT POWER

Typical Performance Characteristics (Continued)

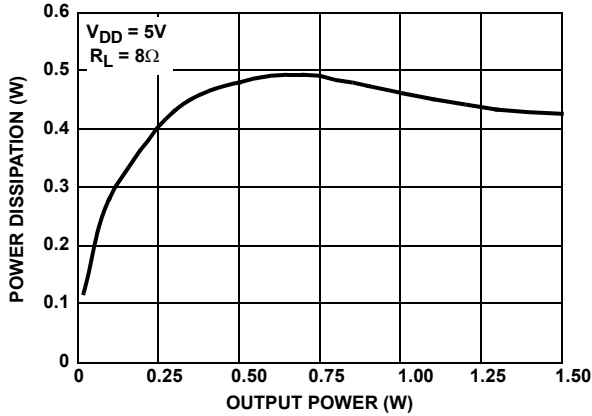

FIGURE 7. POWER DISSIPATION vs OUTPUT POWER

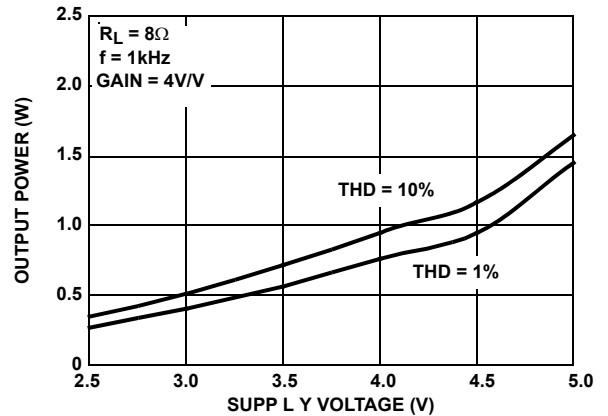

FIGURE 8. OUTPUT POWER vs SUPPLY VOLTAGE

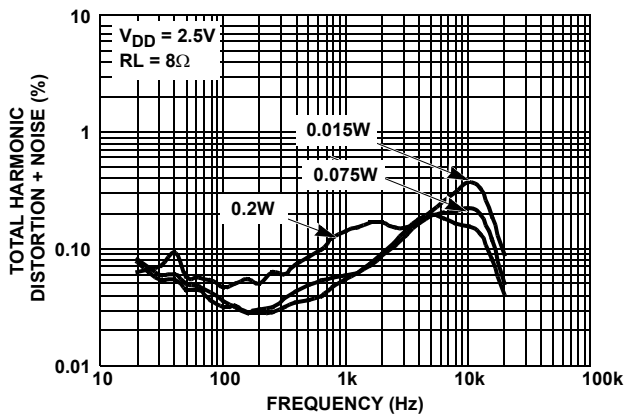

FIGURE 9. TOTAL HARMONIC DISTORTION + NOISE vs FREQUENCY

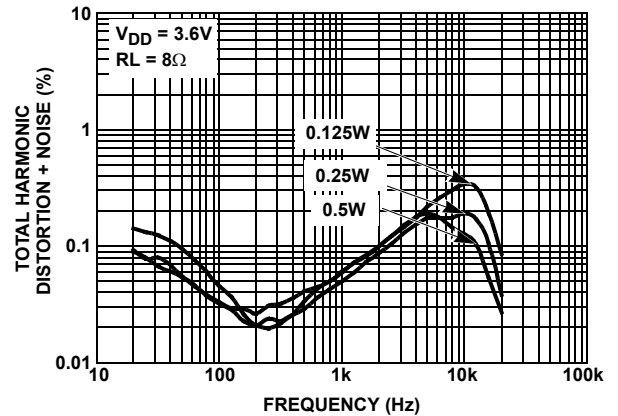

FIGURE 10. TOTAL HARMONIC DISTORTION + NOISE vs FREQUENCY

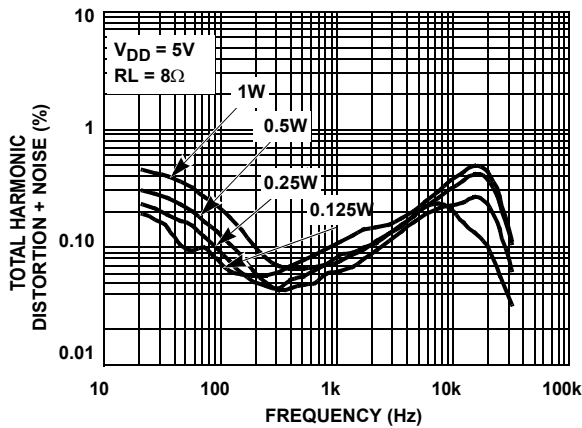

FIGURE 11. TOTAL HARMONIC DISTORTION + NOISE vs FREQUENCY

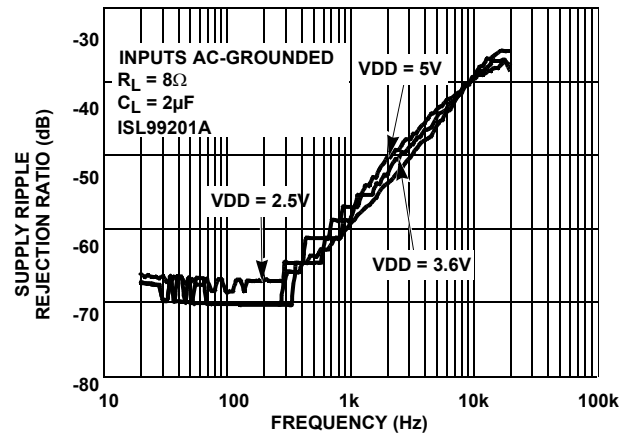

FIGURE 12. SUPPLY RIPPLE REJECTION RATIO vs FREQUENCY - ISL99201A

Typical Performance Characteristics (Continued)

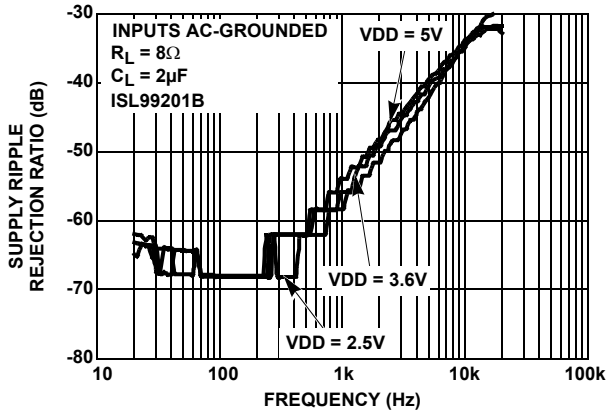

FIGURE 13. SUPPLY RIPPLE REJECTION RATIO vs FREQUENCY - ISL99201B

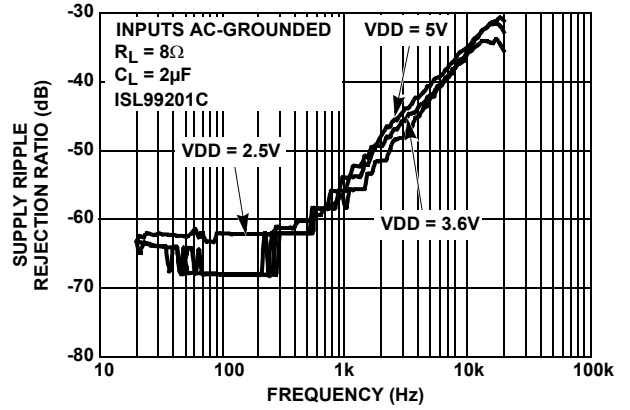

FIGURE 14. SUPPLY RIPPLE REJECTION RATIO vs FREQUENCY - ISL99201C

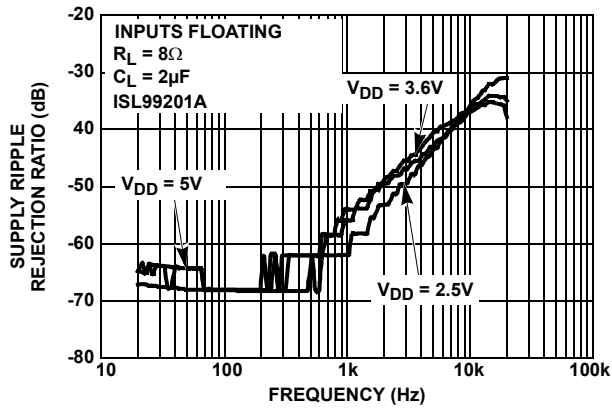

FIGURE 15. SUPPLY RIPPLE REJECTION RATIO vs FREQUENCY - ISL99201A

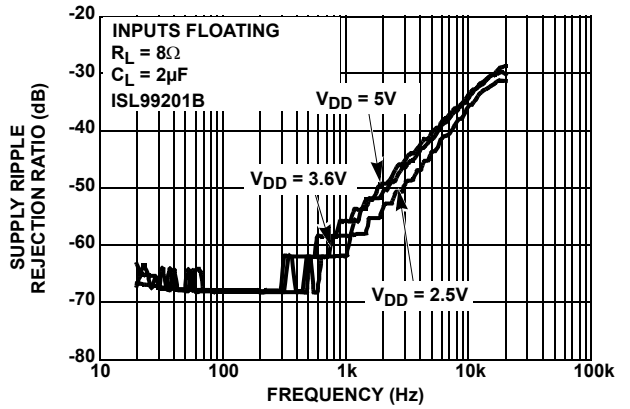

FIGURE 16. SUPPLY RIPPLE REJECTION RATIO vs FREQUENCY - ISL99201B

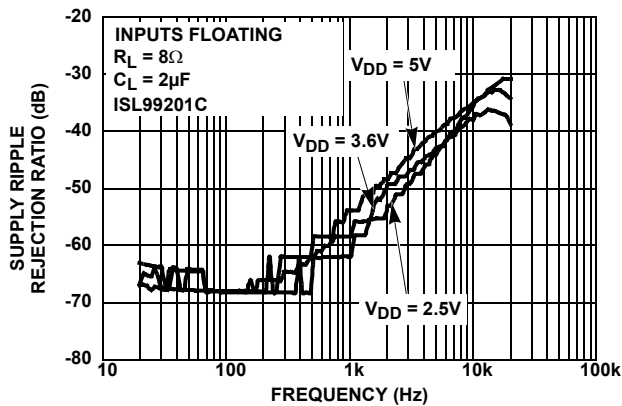

FIGURE 17. SUPPLY RIPPLE REJECTION RATIO vs FREQUENCY - ISL99201C

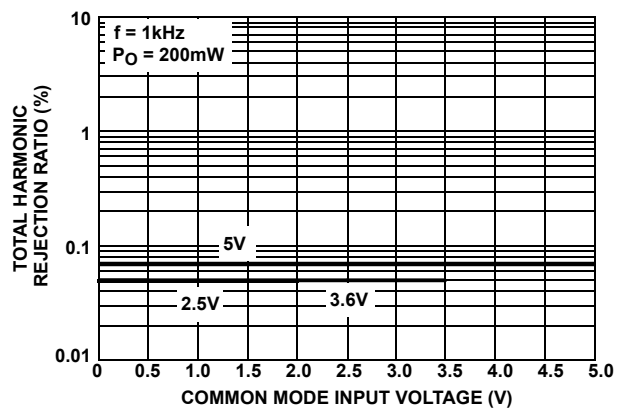

FIGURE 18. TOTAL HARMONIC DISTORTION + NOISE vs COMMON MODE INPUT VOLTAGE

Typical Performance Characteristics (Continued)

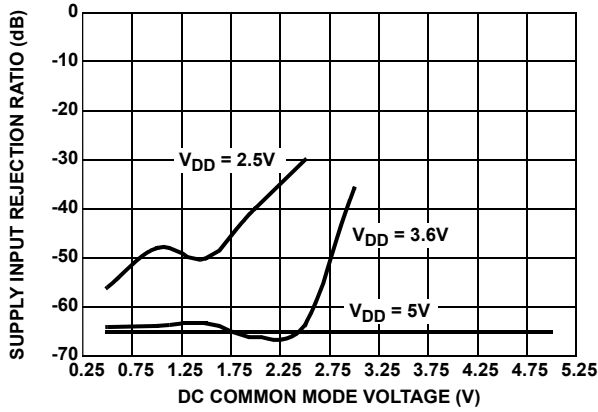

FIGURE 19. SUPPLY RIPPLE REJECTION RATIO vs DC COMMON MODE VOLTAGE

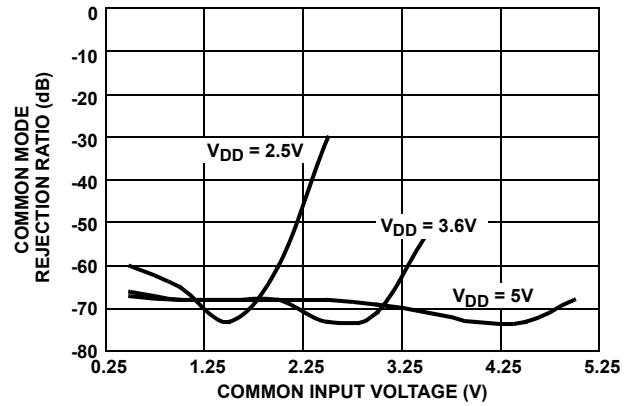

FIGURE 20. COMMON MODE REJECTION RATIO vs COMMON MODE INPUT VOLTAGE

Typical Applications

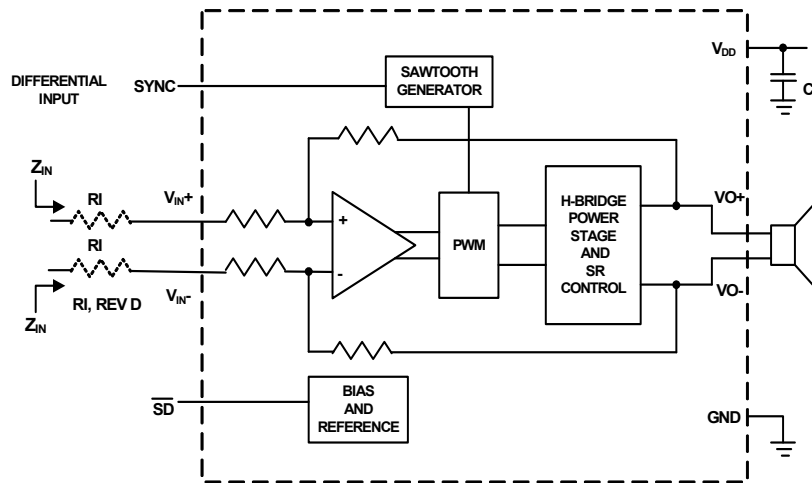

FIGURE 21. TYPICAL CIRCUIT WITH DIFFERENTIAL INPUT

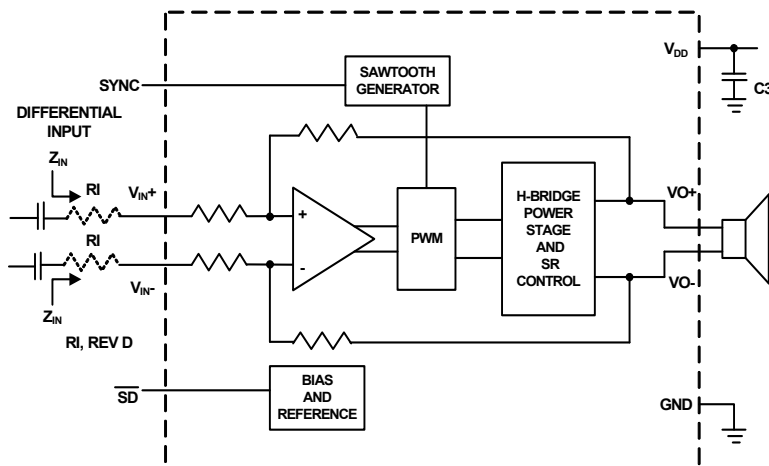

FIGURE 22. TYPICAL CIRCUIT WITH DIFFERENTIAL INPUT AND INPUT CAPACITORS

Typical Applications (Continued)

FIGURE 23. TYPICAL CIRCUIT WITH SINGLE-ENDED INPUT

© Copyright Intersil Americas LLC 2009-2013. All Rights Reserved.
 All trademarks and registered trademarks are the property of their respective owners.

For additional products, see www.intersil.com/en/products.html

Intersil products are manufactured, assembled and tested utilizing ISO9001 quality systems as noted in the quality certifications found at www.intersil.com/en/support/qualandreliability.html

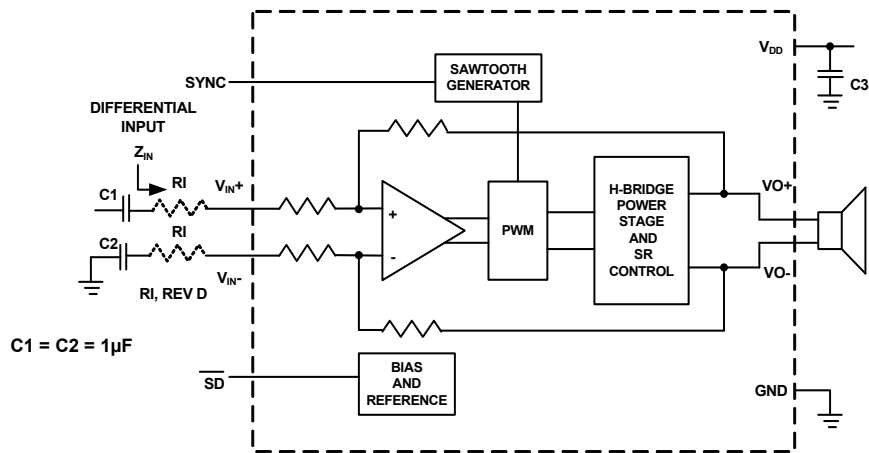
Intersil products are sold by description only. Intersil may modify the circuit design and/or specifications of products at any time without notice, provided that such modification does not, in Intersil's sole judgment, affect the form, fit or function of the product. Accordingly, the reader is cautioned to verify that datasheets are current before placing orders. Information furnished by Intersil is believed to be accurate and reliable. However, no responsibility is assumed by Intersil or its subsidiaries for its use; nor for any infringements of patents or other rights of third parties which may result from its use. No license is granted by implication or otherwise under any patent or patent rights of Intersil or its subsidiaries.

For information regarding Intersil Corporation and its products, see www.intersil.com

Package Outline Drawing

For the most recent package outline drawing, see [L8.3x3A](#).

L8.3x3A
8 LEAD THIN DUAL FLAT NO-LEAD PLASTIC PACKAGE
 Rev 4, 2/10

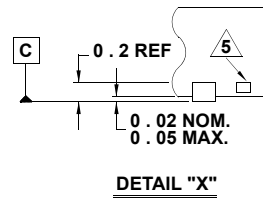
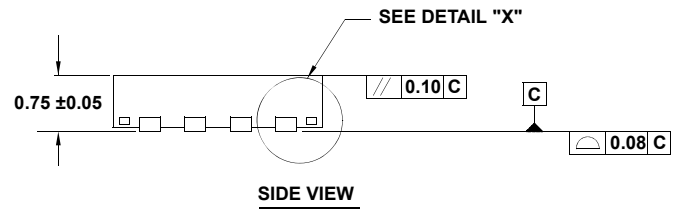
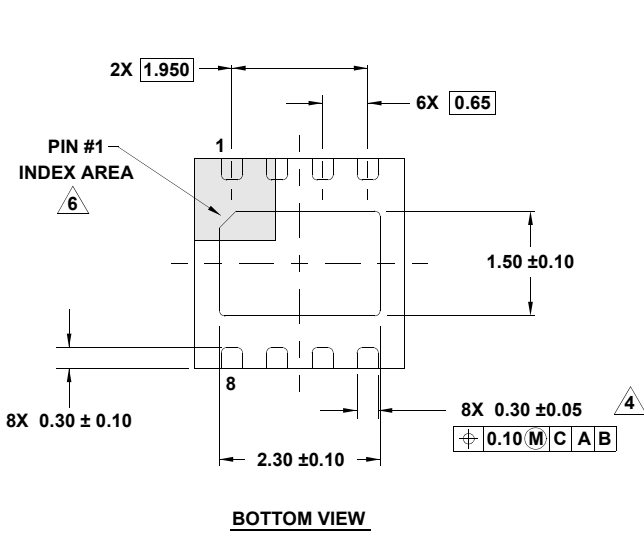
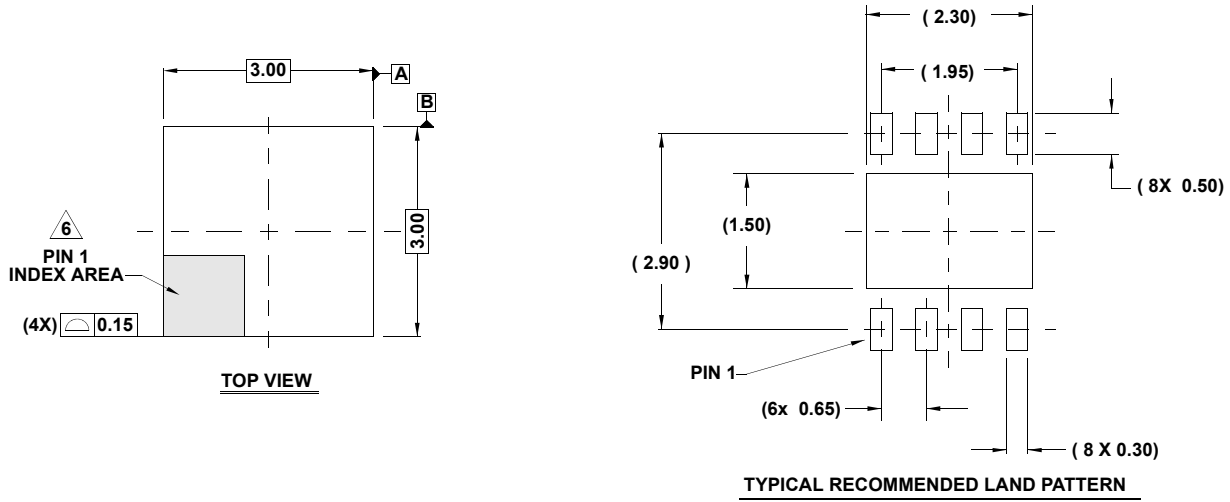

NOTES:

1. Dimensions are in millimeters.
Dimensions in () for Reference Only.
2. Dimensioning and tolerancing conform to ASME Y14.5m-1994.
3. Unless otherwise specified, tolerance : Decimal ± 0.05
4. Dimension applies to the metallized terminal and is measured between 0.15mm and 0.20mm from the terminal tip.
5. Tiebar shown (if present) is a non-functional feature.
6. The configuration of the pin #1 identifier is optional, but must be located within the zone indicated. The pin #1 identifier may be either a mold or mark feature.
7. Compliant to JEDEC MO-229 WEEC-2 except for the foot length.