

SPECIFICATIONS

CUSTOMER	:	_____
SAMPLE CODE	:	SRA128800T004ZZC06
MASS PRODUCTION CODE	:	HRA128800T004ZZC06
SAMPLE VERSION	:	01
SPECIFICATIONS EDITION	:	002
DRAWING NO. (Ver.)	:	LMD-HRA128800T004ZZC06 (Ver.002)
PACKAGING NO. (Ver.)	:	PKG-HRA128800T004ZZC06 (Ver.001)

Customer Approved

Date:

Approved	Checked	Designer
林裘中 Daniel Lin	呂清溪 Marcs Lu	王兆以 Hank Wang

- Preliminary specification for design input
 Specification for sample approval

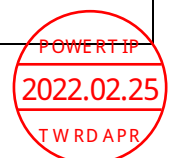

POWERTIP TECH. CORP.

Headquarters: No.8, 6th Road, Taichung Industrial Park,
Taichung, Taiwan
台中市 407 工業區六路 8 號

TEL: 886-4-2355-8168

FAX: 886-4-2355-8166

E-mail: sales@powertip.com.tw

Http://www.powertip.com.tw

CONTENTS

1. SPECIFICATIONS

- 1.1 Features**
- 1.2 Mechanical Specifications**
- 1.3 Absolute Maximum Ratings**
- 1.4 DS Electrical Characteristics**
- 1.5 Optical Characteristics**

2. MODULE STRUCTURE

- 2.1 Counter Drawing**
- 2.2 Interface Pins**
- 2.3 Interface Pin Description**

3. QUALITY ASSURANCE SYSTEM

- 3.1 Quality Assurance Flow Chart**

4. RELIABILITY TEST

- 4.1 Reliability Test Condition**

5. PRECAUTION RELATING PRODUCT HANDLING

- 5.1 Safety**
- 5.2 Handling**
- 5.3 Storage**
- 5.4 Terms of Warranty**

APPENDIX

- 1. Drawing**
- 2. Packaging Specifications**
- 3. Assembly Guide**

1. SPECIFICATIONS

1.1 Features

Hardware

CPU	RISC Processor	PX30 Quad-Core ARM Cortex-A35
Memory	On Board RAM	2GB DDR3L SDRAM
	On Board ROM	8GB eMMC Flash
	External Storage	1 × Micro SD (max. 32G)
Display	Resolution	1280 × 800 (RGB) DOTS
	Display mode	Transmissive, Normally Black
	Touch type	Projective Capacitive Touch Panel
	Interface	8-bit LVDS
I/O	USB	1 × USB OTG 2 × USB1.1/2.0 Compliant Host
	Ethernet	10/100 Mbps
	Analog Audio	1 × Output 1 × Input
	Wi-Fi	IEEE 802.11 a/b/g/n/ac
	Bluetooth	4.2
	Display	1 × LVDS
	Serial	6 × UART (One for Debug Used) 3 × I2C 1 × SPI
Power Input	DC	9V ~ 24V

Software

OS	Embedded	Debian 9 (Linux 4.4.194)
----	----------	--------------------------

1.2 Mechanical Specifications

Item	Standard Value	Unit
Outline Dimension (PCBA)	186.10(W) × 87.0(L) × 25.0(H) MAX	mm
Outline Dimension (Display)	254.96(W) × 173.6(L) × 8.5(H) MAX	mm
Active Area (Display)	216.96(W) × 135.60(L)	mm

1.3 Absolute Maximum Ratings

T_a = 25°C

Item	Symbol	Condition	Min.	Max.	Unit
Power Supply	V _{IN}	—	-0.3	26.0	V
Operating Temperature (T _s)	T _{OP}	—	0	70	°C
Storage Temperature (T _a)	T _{OP}	—	-30	80	°C
Humidity	H _D	T _a =60 °C	10	90	%RH

The absolute maximum rating values of this product are not allowed to be exceeded at any times. Should a module be used with any of the absolute maximum ratings exceeded, the characteristics of the module may not be recovered, or in an extreme case, the product may be permanently destroyed.

Note 1: T_s is the temperature of panel's surface,

Note 2: T_a is the ambient temperature of samples.

1.4 DC Electrical Characteristics

T_a = 25°C

Item	Symbol	Condition	Min.	Typ.	Max.	Unit
Power Supply Voltage	V _{IN}	-	9	12	24	V
Power Supply Current	I _{IN1}	V _{IN} = 12V	-	0.8	-	A
IO High-Level input voltage	V _{IH}	-	0.7×V _{DD3V3}	-	V _{DD3V3} +0.3	V
IO Low-Level input voltage	V _{IL}	-	-0.3	-	0.3×V _{DD3V3}	V
IO High-Level output voltage	V _{OH}	-	-	-	3.6	V
IO Low-Level output voltage	V _{OL}	-	-0.3	-	-	V

Note 1: V_{IN} is connected to 'J4' connector.

1.5 Optical Characteristics

Ta = 25°C

Item		Symbol	Condition	Min.	Typ.	Max.	unit	-
Response time	Tr+Tf	25°C	-	-	25	50	ms	-
Viewing angle	Top	$\theta Y+$	CR \geq 10	-	85	-	Deg.	Note 4
	Bottom	$\theta Y-$		-	85	-		
	Left	$\theta X-$		-	85	-		
	Right	$\theta X+$		-	85	-		
Contrast ratio		CR		600	800	-	-	Note 3
Color of CIE Coordinate (With B/L & T/P)	White	X	(Ta = 25°C) $\theta X, \theta Y = 0^\circ$	0.26	0.31	0.36	-	Note 1
		Y		0.30	0.35	0.40		
	Red	X		0.55	0.60	0.65		
		Y		0.29	0.34	0.39		
	Green	X		0.27	0.32	0.37		
		Y		0.54	0.59	0.64		
	Blue	X		0.10	0.15	0.20		
		Y		0.11	0.16	0.21		
Average Brightness Pattern=white display (With T/P)*1		IV	-	700	800	-	cd/m ²	Note 1
Uniformity (With T/P)*2		ΔB		70	-	-	%	Note 1

Note 1:

*1 : $\Delta B = B(\min) / B(\max) * 100\%$

*2 : Measurement Condition for Optical Characteristics:

- a: Environment: $25 \pm 5^\circ\text{C}$ / $60 \pm 20\%$ RH, no wind, dark room below 10 Lux at typical lamp current and typical operating frequency.
- b: Measurement Distance: 500 ± 50 mm, ($\theta = 0^\circ$)
- c: Equipment: TOPCON BM-7 fast, (field 1°), after 10 minutes operation.
- d: The uncertainty of the C.I.E coordinate measurement ± 0.01 , Average Brightness $\pm 4\%$

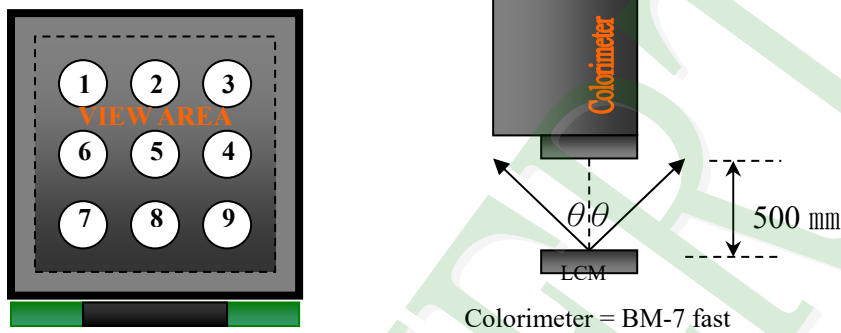

To be measured at the center area of panel with a viewing cone of 1° by Topcon luminance meter BM-7, after 10 minutes operation (module)

Note2: Definition of response time:

The output signals of photo detector are measured when the input signals are changed from "black" to "white" (falling time) and from "white" to "black" (rising time), respectively. The response time is defined as the time interval between the 10% and 90% of Amplitudes.

Refer to figure as below:
Normally White

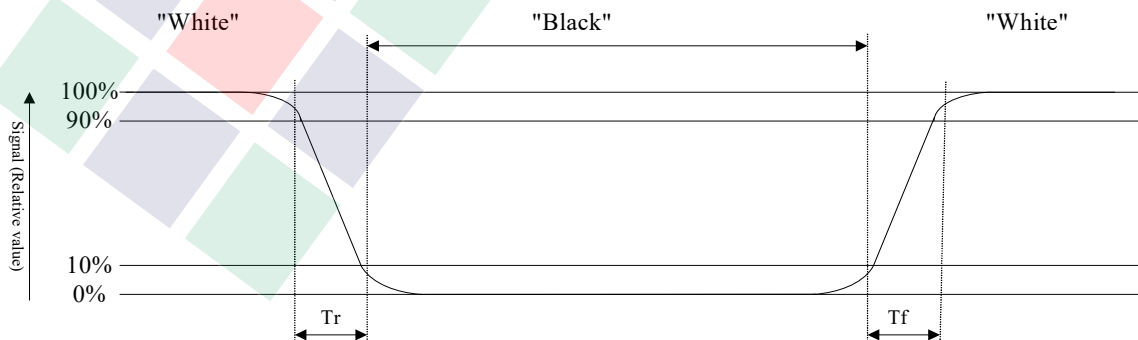

Normally Black

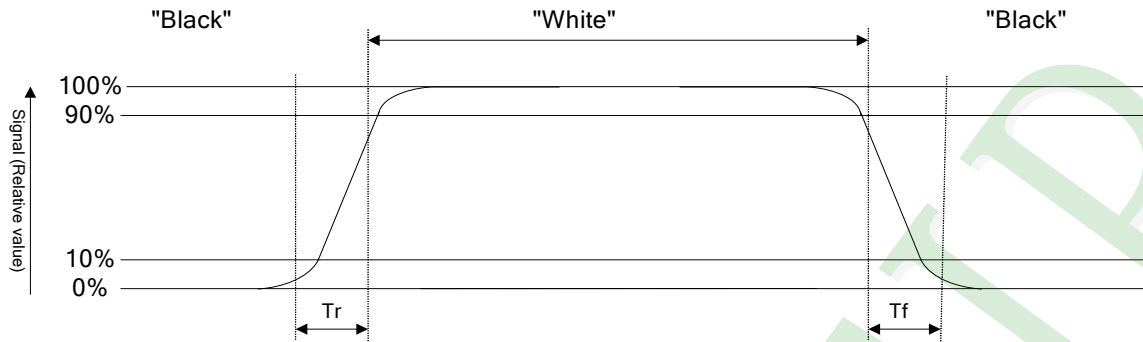

Note3: Definition of contrast ratio:

Contrast Ratio is calculated with the following formula:

$$\text{Contrast Ratio (C.R.)} = \frac{\text{Photo detector output when LCD is at "White" state}}{\text{Photo detector output when LCD is at "Black" state}}$$

Note4: Definition of viewing angle:

Refer to figure as below:

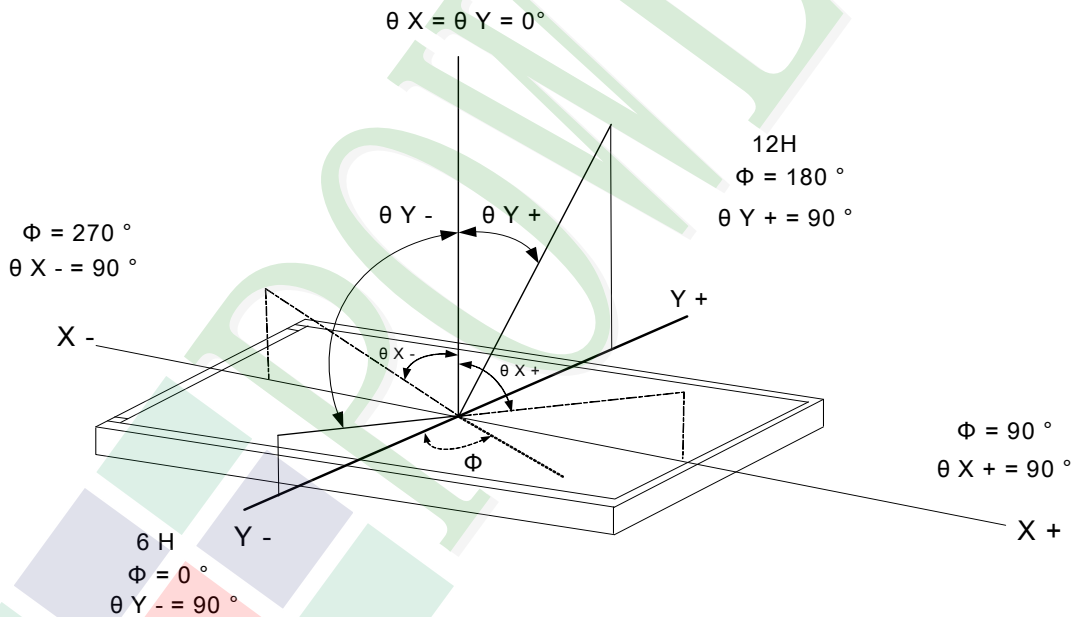

2. MODULE STRUCTURE

2.1 Counter Drawing

2.1.1 LCM Mechanical Diagram

* See Appendix

2.1.2 Block Diagram

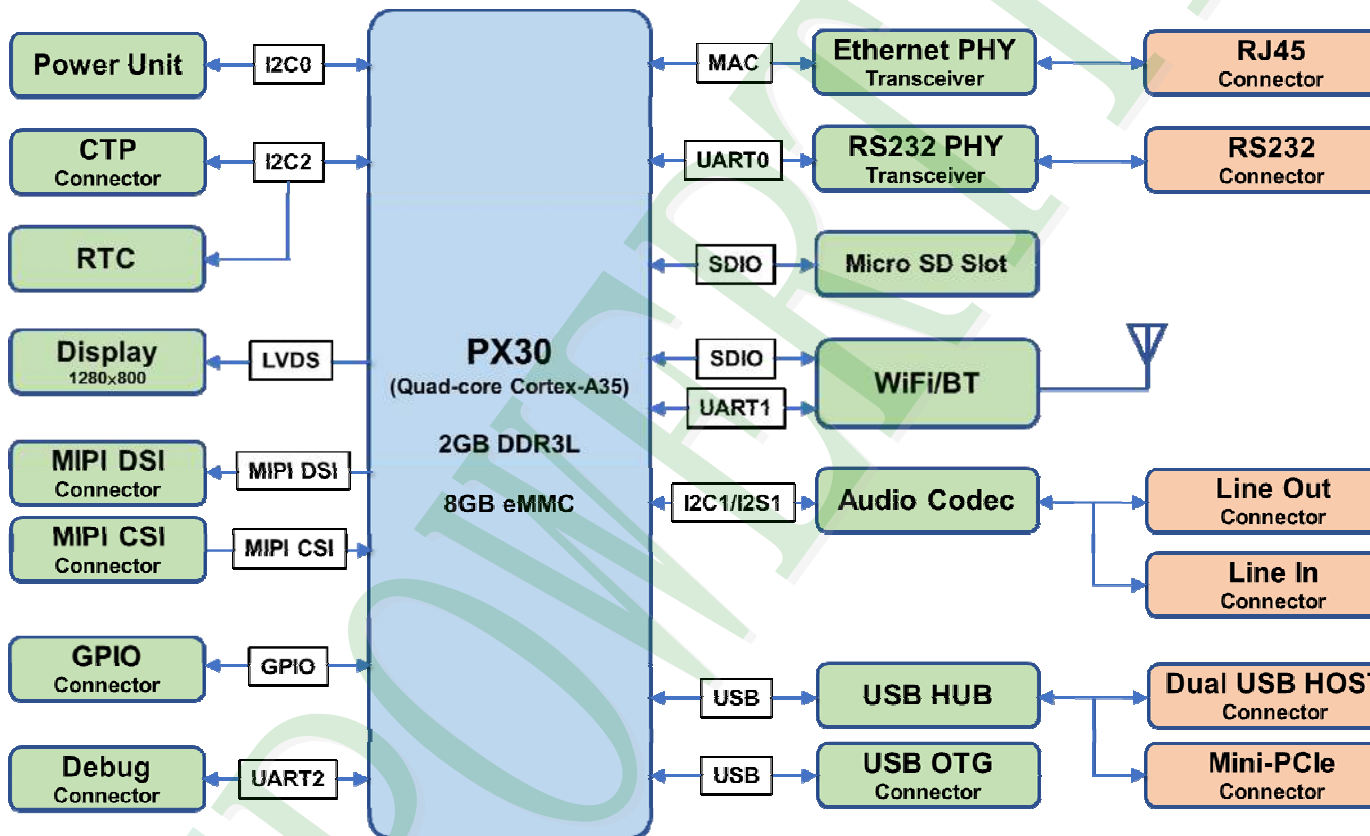

2.2 Interface Pins

Symbol	DESCRIPTION	NOTE
--------	-------------	------

J1	SODIMM 204 PIN	
J2	Boot Mode Control	
J3	RTC Power Supply (Pitch 1.25mm)	
J4	System Power Supply	
J5	Audio Signal Input (Pitch 1.25mm)	
J6	Antenna connector	
J7	HDMI	No function, not used
J8	Expansion	
J9	Pitch 0.5mm 30pin connector bottom contact)	
J11	CTP Interface (Pitch 1.25mm 6pin)	
J12	CTP Interface (Pitch 0.5mm 6pin connector bottom contact)	
J13	RGB Interface (Pitch 0.5mm 50pin connector bottom contact)	
J14	LVDS, MIPI DSI Interface (Pitch 2.0mm, 2x20pin)	
J15	RGB Interface (Pitch 2.0mm, 2x20pin)	
J16	Backlight Power (Pitch 2.0mm 6pin)	
J17	USB CTP	
J18	MicroSD Card	
J19	USB 2.0 Device Mini USB	
J20	USB 1.1/2.0 Host USB Port A Type	
J22	Mini PCIe	
J23	Power Output (Pitch 1.25mm)	
J25	Debug (Pitch 1.25mm, 4pin)	
J26	RS232 (Pitch 2.0mm, 2x5pin)	
J27	UART0	No function, not used
J29	GPIO (Pitch 2.0mm, 2x10pin)	
J30	MIPI CSI (Pitch 0.5mm 30pin connector bottom contact)	
J31	Pitch 0.5mm 24pin connector bottom contact	
J34	Ethernet RJ45	
BAT1	Battery Slot (CR1220)	
JP1	Boot Mode Switch	
CN2	Audio Signal Output (Standard Earphone Jack \varnothing 3.5mm)	
SW1	Reset System	
SW2	PMIC Power On	
SW3	ADC2 Key In	

2.3 Interface Pin Description

J1 --- SODIMM 204 PIN

J2 --- Boot Mode Control

Pin No.	Symbol	Type	DESCRIPTION
1	PWEN	IO	Power Enable
2	BOOT_MODE0	P	External RTC Power Supply
3	BTN_RSTIN_n	IO	Reset System
4	V _{SUHTDOWN3V3}	P	+3.3V Output (shutdown)
5	PMIC_PWRON	IO	PMIC (RK809), Power On
6	GND	P	Ground

J3 --- RTC Power Supply (Pitch 1.25mm)

Pin No.	Symbol	Type	DESCRIPTION
1	GND	P	Ground
2	V _{BAT}	P	External RTC Power Supply

J4 --- System Power Supply

Pin No.	Symbol	Type	DESCRIPTION
+	V _{IN}	P	DC Power Supply of System
-	GND	P	Ground

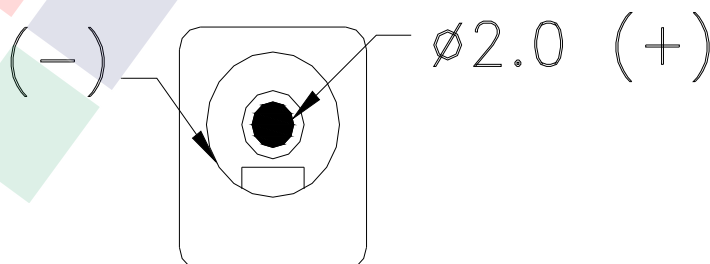

J5 --- Audio Signal Input (Pitch 1.25mm)

Pin No.	Symbol	Type	DESCRIPTION
1	LINEINL	A	Line-in Left Channel Input
2	LINEINR	A	Line-in Right Channel Input
3	GND	P	Ground
4	GND	P	Ground

J6 --- Antenna connector

Pin No.	Symbol	Type	DESCRIPTION
1	S	IO	Data signal
2	G	P	Ground
3	G	P	Ground

J7 --- HDMI (No function, not used)
J8 --- Expansion

Pin No.	Symbol	Type	DESCRIPTION
1	V _{SHUTDOWN3V3}	P	+3.3V Output (shutdown)
2	PWEN	IO	Power Enable
3	I2C1_SCL	IO	I2C1 Serial Clock
4	I2C1_SDA	IO	I2C1 Serial Data
5	EFM_INIT1_EXTBTN	-	Reserved
6	NC	-	Not Connection
7	EFM_URX	-	Reserved
8	EFM_C2CK/RST	-	Reserved
9	EFM_C2D/P20	-	Reserved
10	GND	P	Ground

J9 – Pitch 0.5mm 30pin connector bottom contact)

Function	Symbol	Type	DESCRIPTION	J9
Power	V _{LCD3V3}	P	+3.3V Power Supply for Display Module	3,4
	V _{DD3V3}	P	+3.3V Output	7
	V _{DD5V}	P	+5.0V Output	1,2
	GND	P	Ground	6,8,13,15,18, 21,24,27,30
Other	I2C2_SDA	IO	I2C Port2 Serial Data	9
	I2C2_SCL	IO	I2C Port2 Serial Clock	10
	CTP_RST	O	CTP Reset Signal	11
	CTP_INT	I	CTP Interrupt Signal	12
	NC	-	Not connection	5,14,16,17, 19,29,22,23, 25,26,28,29

J11 --- CTP Interface (Pitch 1.25mm 6pin)

Pin No.	Symbol	Type	DESCRIPTION
1	GND	P	Ground
2	I2C2_SDA	IO	I2C Port2 Serial Data
3	I2C2_SCL	IO	I2C Port2 Serial Clock
4	CTP_INT	I	CTP Interrupt Signal
5	CTP_RST	O	CTP Reset Signal
6	V _{DD3V3}	P	+3.3V

J12 --- CTP Interface (Pitch 0.5mm 6pin connector bottom contact)

Pin No.	Symbol	Type	DESCRIPTION
1	GND	P	Ground
2	V _{DD3V3}	P	+3.3V
3	I2C2_SCL	IO	I2C Port2 Serial Clock

Pin No.	Symbol	Type	DESCRIPTION
4	I2C2_SDA	IO	I2C Port2 Serial Data
5	CTP_INT	I	CTP Interrupt Signal
6	CTP_RST	O	CTP Reset Signal

Display Interface --- RGB

(J13 – Pitch 0.5mm 50pin connector bottom contact, J15 – Pitch 2.0mm, 2x20pin)

Function	Symbol	Type	DESCRIPTION	J13	J15
Power	V _{LCD3V3}	P	+3.3V power supply for Display module	2,3	1,2,3
	V _{DD5V}	P	+5.0V Output	4,5	39
	GND	P	Ground.	1,7,12,17,22, 27,32,37,40, 42,44,50	4,5,6,13,14, 19,20,40
RGB Signal	LCDC_D0	IO	LCDC data 0 (Blue 0)	28	8
	LCDC_D1		LCDC data 1 (Blue 1)	29	7
	LCDC_D2		LCDC data 2 (Blue 2)	30	10
	LCDC_D3		LCDC data 3 (Blue 3)	31	9
	LCDC_D4		LCDC data 4 (Blue 4)	33	12
	LCDC_D5		LCDC data 5 (Blue 5)	34	11
	LCDC_D6		LCDC data 6 (Blue 6)	35	18
	LCDC_D7		LCDC data 7 (Blue 7)	36	17
	LCDC_D8		LCDC data 8 (Green 0)	18	22
	LCDC_D9		LCDC data 9 (Green 1)	19	21
	LCDC_D10		LCDC data 10 (Green 2)	20	16
	LCDC_D11		LCDC data 11 (Green 3)	21	15
	LCDC_D12		LCDC data 12 (Green 4)	23	24
	LCDC_D13		LCDC data 13 (Green 5)	24	23
	LCDC_D14		LCDC data 14 (Green 6)	25	26
LCDC_D15	LCDC data 15 (Green 7)	26	25		

Function	Symbol	Type	DESCRIPTION	J13	J15
RGB Signal	LCDC_D16	IO	LCDC data 16 (Red 0)	8	28
	LCDC_D17		LCDC data 17 (Red 1)	9	27
	LCDC_D18		LCDC data 18 (Red 2)	10	30
	LCDC_D19		LCDC data 19 (Red 3)	11	29
	LCDC_D20		LCDC data 20 (Red 4)	13	32
	LCDC_D21		LCDC data 21 (Red 5)	14	31
	LCDC_D22		LCDC data 22 (Red 6)	15	34
	LCDC_D23		LCDC data 23 (Red 7)	16	33
Others	NC	-	Not Connection	13,14,18,19,38,39,41,43,45,46,47	35,36,37,38
	DISP_CTL	O	Display On/Off Signal, '1' = On, '0' = Off	48	-
	DISP_RST	O	Display reset signal by RC circuit, connect a 10K ohm resistor to V _{DD3V3} and a 100nF capacitor to GND	49	-
	DISP_PWM	O	Backlight PWM Control Signal	6	-

Display Interface --- LVDS, MIPI DSI (J14 – Pitch 2.0mm, 2x20pin)

Function	Symbol	Type	DESCRIPTION	J14
Power	V _{LCDD3V3}	P	+3.3V power supply for Display module	1,2,3
	V _{DD5V}	P	+5.0V Output	39
	GND	P	Ground	4,5,6,13,14,19,20,22,31,32,40
LVDS Signal	LVDS0_TX0_N	DS	LVDS Chanel 0 Data 0 Negative	7
	LVDS0_TX0_P		LVDS Chanel 0 Data 0 Positive	8
	LVDS0_TX1_N		LVDS Chanel 0 Data 1 Negative	9
	LVDS0_TX1_P		LVDS Chanel 0 Data 1 Positive	10
	LVDS0_TX2_N		LVDS Chanel 0 Data 2 Negative	11
	LVDS0_TX2_P		LVDS Chanel 0 Data 2 Positive	12

Function	Symbol	Type	DESCRIPTION	J14
LVDS Signal	LVDS0_TX3_N	DS	LVDS Chanel 0 Data 3 Negative	17
	LVDS0_TX3_P		LVDS Chanel 0 Data 3 Positive	18
	LVDS0_CLK_N		LVDS Chanel 0 Clock Negative	15
	LVDS0_CLK_P		LVDS Chanel 0 Clock Positive	16
MIPI DSI Signal	MIPI_TX_D0_N	DS	MIPI DSI Data 0 Negative	7
	MIPI_TX_D0_P		MIPI DSI Data 0 Positive	8
	MIPI_TX_D1_N		MIPI DSI Data 1 Negative	9
	MIPI_TX_D1_P		MIPI DSI Data 1 Positive	10
	MIPI_TX_D2_N		MIPI DSI Data 2 Negative	11
	MIPI_TX_D2_P		MIPI DSI Data 2 Positive	12
	MIPI_TX_D3_N		MIPI DSI Data 3 Negative	17
	MIPI_TX_D3_P		MIPI DSI Data 3 Positive	18
	MIPI_TX_CLK_N		MIPI DSI Clock Negative	15
	MIPI_TX_CLK_P		MIPI DSI Clock Positive	16
Other	CTP_INT	IO	Touch panel & Touch key interrupt	36
	CTP_RST		Touch panel reset	38
	I2C2_SCL	IO	I2C serial port 2, for touch panel	35
	I2C2_SDA		I2C serial port 2, for touch panel	37
	NC	-	Not Connection	21,23,24,25, 26,27,28,29, 30,33,34

J16 --- Backlight Power (Pitch 2.0mm 6pin)

Pin No.	Symbol	Type	DESCRIPTION
1	VBLOUT	P	VBLOUT is connected to V _{IN} directly
2	VBLOUT	P	VBLOUT is connected to V _{IN} directly
3	GPIO0_A1	IO	General-Purpose I/O
4	PWM2	O	PWM signal output for backlight
5	GND	P	Ground
6	GND	P	Ground

J17 --- USB CTP

Pin No.	Symbol	Type	DESCRIPTION
1	V _{DD5V}	P	+5.0V Output
2	D-	DS	Data – (Data M)
3	D+	DS	Data + (Data P)
4	GND	P	Ground
5	GND	P	Ground

J18 --- MicroSD Card

Pin No.	Symbol	Type	DESCRIPTION
1	SD2_DATA2	IO	SD2 data signal 2
2	SD2_DATA3	IO	SD2 data signal 3
3	SD2_CMD	IO	SD2 command signal
4	V _{DD3V3}	P	+3.3V Output
5	SD2_CLK	IO	SD2 clock signal
6	GND	P	Ground
7	SD2_DATA0	IO	SD2 data signal 0
8	SD2_DATA1	IO	SD2 data signal 1
9	SD2_CD	IO	SD2 card detection
10	GND	P	Ground
11	GND	P	Ground
12	GND	P	Ground
13	GND	P	Ground
14	NC	-	Not Connection

J19 --- USB 2.0 Device Mini USB

Pin No.	Symbol	Type	DESCRIPTION
1	V _{USB5V}	P	+5.0V USB Power Supply
2	D-	DS	Data – (Data M)
3	D+	DS	Data + (Data P)
4	ID	-	USB ID
5	GND	P	Ground

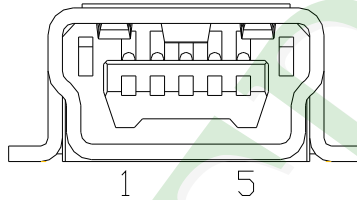

J20 --- USB 1.1/2.0 Host USB Port A Type

Upper & Bottom

Pin No.	Symbol	Type	DESCRIPTION
1	V _{DD5V}	P	+5.0V Output
2	D-	DS	Data – (Data M)
3	D+	DS	Data + (Data P)
4	GND	P	Ground

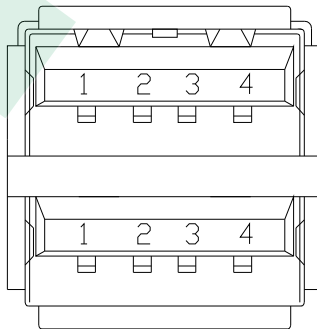

Upper

Bottom

J22 --- Mini PCIe

Function	Symbol	Type	DESCRIPTION	J22
Power	V _{DD1V5}	P	+3.3V Power Supply for Display Module	6,28,48
	V _{DD3V3}	P	+3.3V Output	2,20,24, 39,41,42, 44,46,52
	GND	P	Ground	4,9,15,18 21,26,27, 29,34,35, 37,40,43,50
USB data Signal	D-	DS	Data – (Data M)	36
	D+	DS	Data + (Data P)	38
Other	I2C0_SDA_PMIC	IO	I2C Port0 Serial Data	32
	I2C0_SCL_PMIC	IO	I2C Port0 Serial Clock	30
	NC	-	Not connection	1,3,5,7,8, 10,11,12,13, 14,16,17,19, 22,23,25,31, 33,45,47,49,51

J23 --- Power Output (Pitch 1.25mm)

Pin No.	Symbol	Type	DESCRIPTION
1	V _{DD5V}	P	+5.0V Output
2	V _{DD5V}	P	+5.0V Output
3	GND	P	Ground
4	GND	P	Ground

J25 --- Debug (Pitch 1.25mm, 4pin)

Pin No.	Symbol	Type	DESCRIPTION
1	V _{DD3V3}	P	+3.3V Output
2	UART2_TX_M1	IO	UART2_M1 Transmitter Signal (3.3V Level)
3	UART2_RX_M1	IO	UART2_M1 Receiver Signal (3.3V Level)
4	GND	P	Ground

J26 --- RS232 (Pitch 2.0mm, 2x5pin)

Pin No.	Symbol	Type	DESCRIPTION
1	NC	-	Not Connection
2	RS232_RXD	I	RS232 Receiver Signal (UART0, RS232 level)
3	RS232_TXD	O	RS232 Transmitter Signal (UART0, RS232 level)
4	V _{DD3V3}	P	+3.3V Output
5	GND	P	Ground
6	NC	-	Not Connection
7	RS232_RTS	O	RS232 Request to Send Signal (UART0, RS232 level)
8	RS232_CTS	I	RS232 Clear to Send Signal (UART0, RS232 level)
9	NC	-	Not Connection
10	GND	P	Ground

J27 --- UART0 (No function, not used)
J29 --- GPIO (Pitch 2.0mm, 2x10pin)

Pin No.	Symbol	Type	DESCRIPTION
1	V _{DD3V3}	P	+3.3V Output
2	V _{DD5V}	P	+5.0V Output
3	GND	P	Ground
4	GND	P	Ground
5	NC	-	Not Connection
6	NC	-	Not Connection
7	NC	-	Not Connection
8	I2C1_SCL	IO	I2C1 serial clock
9	NC	-	Not Connection
10	I2C1_SDA	IO	I2C1 serial Data

Pin No.	Symbol	Type	DESCRIPTION
11	NC	-	Not Connection
12	SPI0_CSN	IO	SPI Chip Select Signal
13	NC	-	Not Connection
14	SPI0_CLK	IO	SPI0 Serial Clock Signal
15	NC	-	Not Connection
16	SPI0_RXD	IO	SPI0 Receiver Data Signal
17	NC	-	Not Connection
18	SPI0_TXD	IO	SPI0 Transmitter Data Signal
19	GND	P	Ground
20	GND	P	Ground

**Camera Interface --- MIPI CSI
(J30 – Pitch 0.5mm 30pin connector bottom contact)**

Function	Symbol	Type	DESCRIPTION	J30
Power	V _{DD5V}	P	+5.0V Output	1
	V _{DD1V8}	P	I/O voltage for Camera module	4
	GND	P	Ground	6,8,13,15,18,21,24,27,30
MIPI CSI Signal	MIPI_C_CLK_N	DS	MIPI CSI Clock Negative	26
	MIPI_C_CLK_P		MIPI CSI Clock Positive	25
	MIPI_C_D0_N		MIPI CSI Data 0 Negative	29
	MIPI_C_D0_P		MIPI CSI Data 0 Positive	28
	MIPI_C_D1_N		MIPI CSI Data 1 Negative	23
	MIPI_C_D1_P		MIPI CSI Data 1 Positive	22
	MIPI_C_D2_N		MIPI CSI Data 2 Negative	20
	MIPI_C_D2_P		MIPI CSI Data 2 Positive	19
	MIPI_C_D3_N		MIPI CSI Data 3 Negative	17
	MIPI_C_D3_P		MIPI CSI Data 3 Positive	16

Function	Symbol	Type	DESCRIPTION	J30
Other	CAM_SDA	IO	I2C Por1 Serial Data (1.8V Level)	9
	CAM_SCL	IO	I2C Port1 Serial Clock (1.8V Level)	10
	GPIO2_B0	IO	General-Purpose I/O for Camera module (1.8V Level)	12
	CSI_CLKO	O	Clock output to Camera module (1.8V Level)	14
	NC	-	Not Connection	2,3,5,7,11

J31 – Pitch 0.5mm 24pin connector bottom contact

Pin No.	Symbol	Type	DESCRIPTION
1	GND	P	Ground
2	GND	P	Ground
3	NC	-	Not Connection
4	CIF_CLKO	O	Clock output to Camera module
5	NC	-	Not Connection
6	NC	-	Not Connection
7	NC	-	Not Connection
8	NC	-	Not Connection
9	NC	-	Not Connection
10	NC	-	Not Connection
11	RK809_HPL	O	RK809 Left channel output of the headphone
12	RK809_HPR	O	RK809 Right channel output of the headphone
13	RK809_HPSNS	I	RK809 reference ground for the headphone
14	RK809_SPKN_OUT	O	RK809 positive speaker driver output
15	RK809_SPKP_OUT	O	RK809 positive speaker driver output
16	RK809_MIC1_IN	I	RK809 negative input of the microphone
17	RK809_MIC2_IN	I	RK809 positive input of the microphone
18	ADC1_HP_HOOK	IO	ADC key

Pin No.	Symbol	Type	DESCRIPTION
19	I2C1_SCL	IO	I2C1 Serial Clock
20	I2C1_SDA	IO	I2C1 Serial Data
21	GND	P	Ground
22	V _{DD5V}	P	+5.0V Output
23	V _{DD5V}	P	+5.0V Output
24	V _{DD5V}	P	+5.0V Output

J34 --- Ethernet RJ45

Pin No.	Symbol	Type	DESCRIPTION
1	TX_D1+	DS	Transmit Data +
2	TX_D1-	DS	Transmit Data -
3	RX_D2+	DS	Receive Data +
4	BI_D3+	DS	Bi-directional Data +
5	BI_D3-	DS	Bi-directional Data -
6	RX_D2-	DS	Receive Data -
7	BI_D4+	DS	Bi-directional Data +
8	BI_D4-	DS	Bi-directional Data -

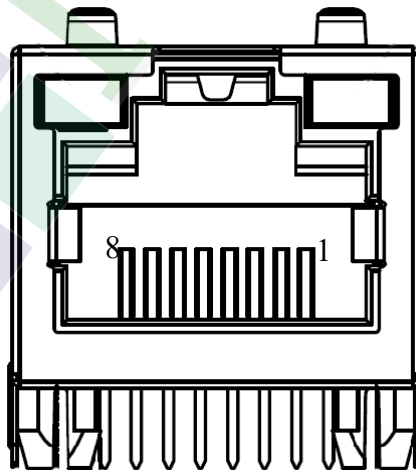

BAT1 --- Battery Slot (CR1220)

Pin No.	Symbol	Type	DESCRIPTION
1	V _{BAT}	P	External Power Supply
2	GND	P	Ground

JP1 --- Boot Mode Switch

Pin No.	Symbol	Type	DESCRIPTION
1	GND	P	Ground
2	NC	-	Not Connection
3	GND	P	Ground
4	BOOT_MODE0	IO	Boot Mode 0

CN2 --- Audio Signal Output

Standard Earphone Jack φ 3.5mm.

SW1 --- Reset System
SW2 --- PMIC Power On
SW3 --- ADC2 Key In

3. QUALITY ASSURANCE SYSTEM

3.1 Quality Assurance Flow Chart

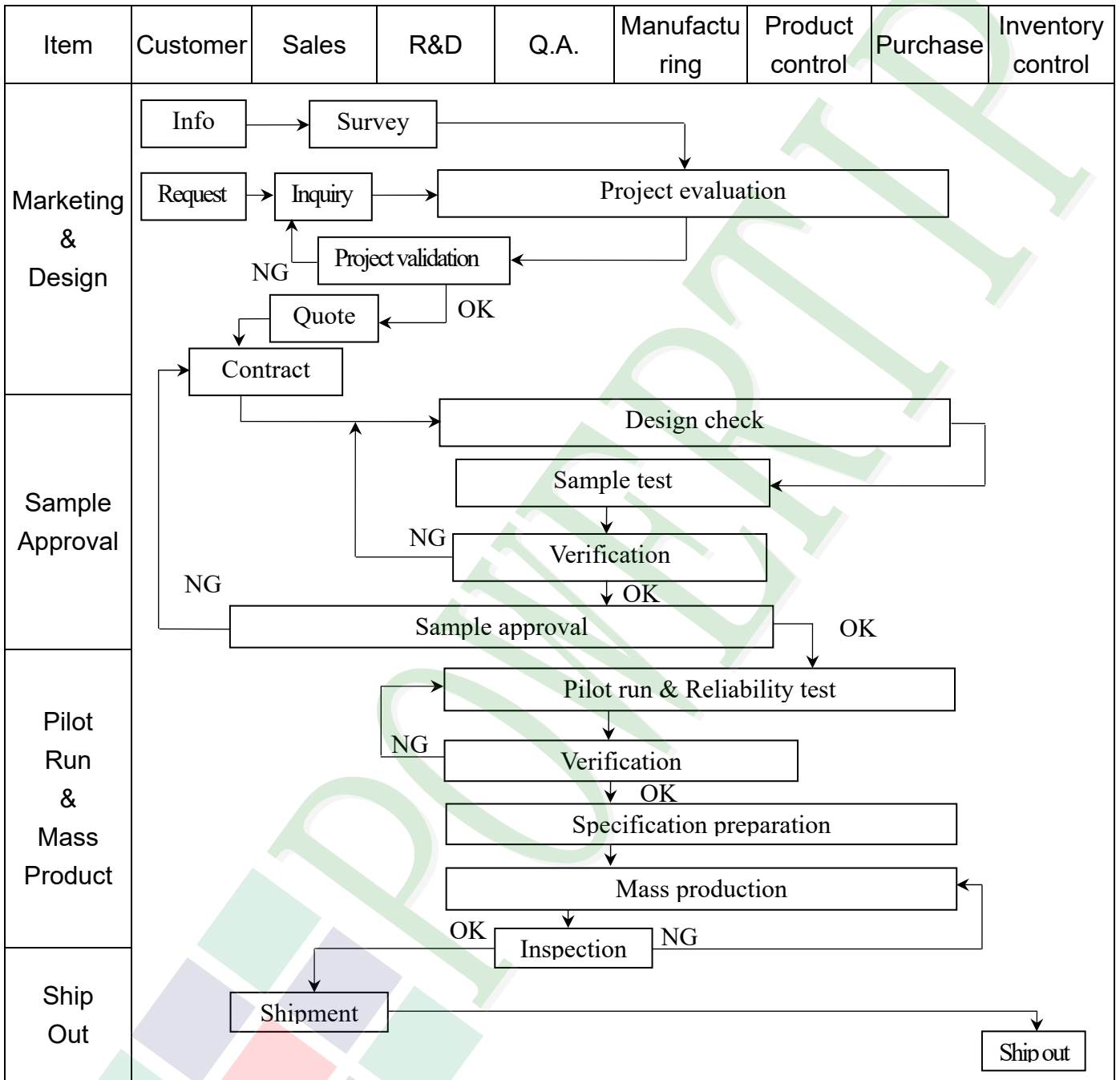

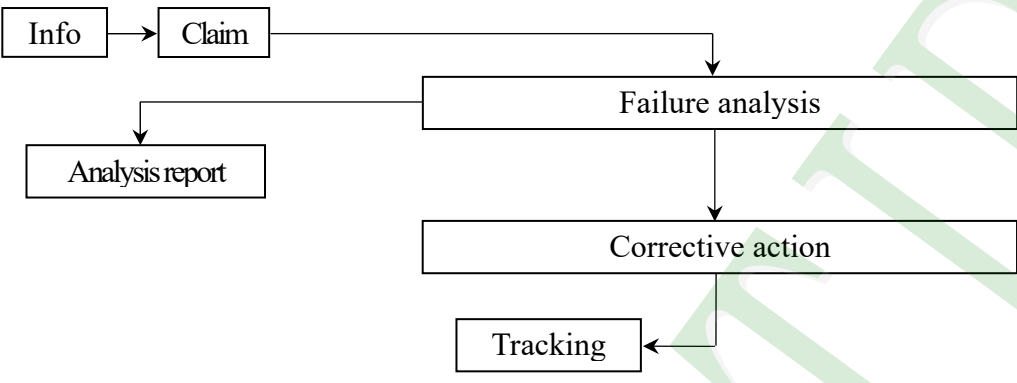
Item	Customer	Sales	R&D	Q.A.	Manufacturing	Product control	Purchase	Inventory control
Sales Service	 <pre> graph TD Info[Info] --> Claim[Claim] Claim --> FA[Failure analysis] Claim --> AR[Analysis report] FA --> CA[Corrective action] CA --> Tracking[Tracking] </pre>							
Q.A Activity	1. ISO 9001 Maintenance Activities 3. Equipment calibration 5. Standardization Management				2. Process improvement proposal 4. Education and Training Activities			

4. RELIABILITY TEST

4.1 Reliability Test Condition

NO.	TEST ITEM	TEST CONDITION										
1	High Temperature Storage Test	Keep in $+80 \pm 2^\circ\text{C}$ 96 hrs. Surrounding temperature, then storage at normal condition 4 hrs.										
2	Low Temperature Storage Test	Keep in $-30 \pm 2^\circ\text{C}$ 96 hrs. Surrounding temperature, then storage at normal condition 4 hrs.										
3	High Temperature / High Humidity Storage Test	Keep in $+60^\circ\text{C}$ / 90% R.H duration for 96 hrs Surrounding temperature, then storage at normal condition 4 hrs. (Excluding the polarizer)										
4	Temperature Cycling Storage Test	$ \begin{array}{c} -30^\circ\text{C} \rightarrow +25^\circ\text{C} \rightarrow +80^\circ\text{C} \rightarrow +25^\circ\text{C} \\ (30\text{mins}) \quad (5\text{mins}) \quad (30\text{mins}) \quad (5\text{mins}) \\ \longleftarrow \hspace{10em} \longrightarrow \\ 10 \text{ Cycle} \end{array} $ Surrounding temperature, then storage at normal condition 4 hrs.										
5	Vibration Test (Packaged)	<ol style="list-style-type: none"> Sine wave 10~55 Hz frequency (1 min) The amplitude of vibration: 1.5 mm Each direction (X, Y, Z) duration for 2 hrs. 										
6	Drop Test (Packaged)	<table border="1"> <thead> <tr> <th>Packing Weight (Kg)</th> <th>Drop Height (cm)</th> </tr> </thead> <tbody> <tr> <td>0 ~ 45.4</td> <td>122</td> </tr> <tr> <td>45.4 ~ 90.8</td> <td>76</td> </tr> <tr> <td>90.8 ~ 454</td> <td>61</td> </tr> <tr> <td>Over 454</td> <td>46</td> </tr> </tbody> </table> <p>Drop direction: 1 corner / 3 edges / 6 sides each 1 times</p>	Packing Weight (Kg)	Drop Height (cm)	0 ~ 45.4	122	45.4 ~ 90.8	76	90.8 ~ 454	61	Over 454	46
Packing Weight (Kg)	Drop Height (cm)											
0 ~ 45.4	122											
45.4 ~ 90.8	76											
90.8 ~ 454	61											
Over 454	46											

5. PRECAUTION RELATING PRODUCT HANDLING

5.1 SAFETY

- 5.1.1 If the LCD panel breaks, be careful not to get the liquid crystal to touch your skin.
- 5.1.2 If the liquid crystal touches your skin or clothes, please wash it off immediately by using soap and water.

5.2 HANDLING

- 5.2.1 Avoid any strong mechanical shock which can break the glass.
- 5.2.2 Avoid static electricity which can damage the CMOS LSI—When working with the module, be sure to ground your body and any electrical equipment you may be using.
- 5.2.3 Do not remove the panel or frame from the module.
- 5.2.4 The polarizing plate of the display is very fragile. So, please handle it very carefully, do not touch, push or rub the exposed polarizing with anything harder than an HB pencil lead (glass, tweezers, etc.)
- 5.2.5 Do not wipe the polarizing plate with a dry cloth, as it may easily scratch the surface of plate.
- 5.2.6 Do not touch the display area with bare hands, this will stain the display area.
- 5.2.7 Do not use ketonic solvent & aromatic solvent. Use with a soft cloth soaked with a cleaning naphtha solvent.
- 5.2.8 To control temperature and time of soldering is $320 \pm 10^{\circ}\text{C}$ and 3 ~ 5 sec.
- 5.2.9 To avoid liquid (include organic solvent) stained on LCM.
- 5.2.10 Caution! (LCM products with Capacitive Touch Panel)
Strong EMI-sources such as switch-mode power supplies (SPS) can lead to touch malfunction (e.g., ghost-touches). Therefore, the touch needs to be thoroughly tested inside the target application.
- 5.2.11 CAUTION: Continuously displaying same static image will result in high possibility of image sticking/image burn-in effect due to TFT panel characteristic.
- 5.2.12 Double-sided tape designed to be attached with the customer's mechanical device, please follow up the rules and regulations published by the original manufacturer of double-side tape for the attachment operation.

5.3 STORAGE

- 5.3.1 Store the panel or module in a dark place where the temperature is $25^{\circ}\text{C} \pm 5^{\circ}\text{C}$ and the humidity is below 65% RH.
- 5.3.2 Do not place the module near organics solvents or corrosive gases.
- 5.3.3 Do not crush, shake, or jolt the module.

5.4 TERMS OF WARRANTY

- 5.4.1 Applicable warrant period
The period is within thirteen months since the date of shipping out under normal using and storage conditions.
- 5.4.2 Unaccepted responsibility
This product has been manufactured to your company's specification as a part for use in your company's general electronic products. It is guaranteed to perform according to delivery specifications. For any other use apart from general electronic equipment, we cannot take responsibility if the product is used in nuclear power control equipment, aerospace equipment, fire and security systems or any other applications in which there is a direct risk to human life and where extremely high levels of reliability are required.

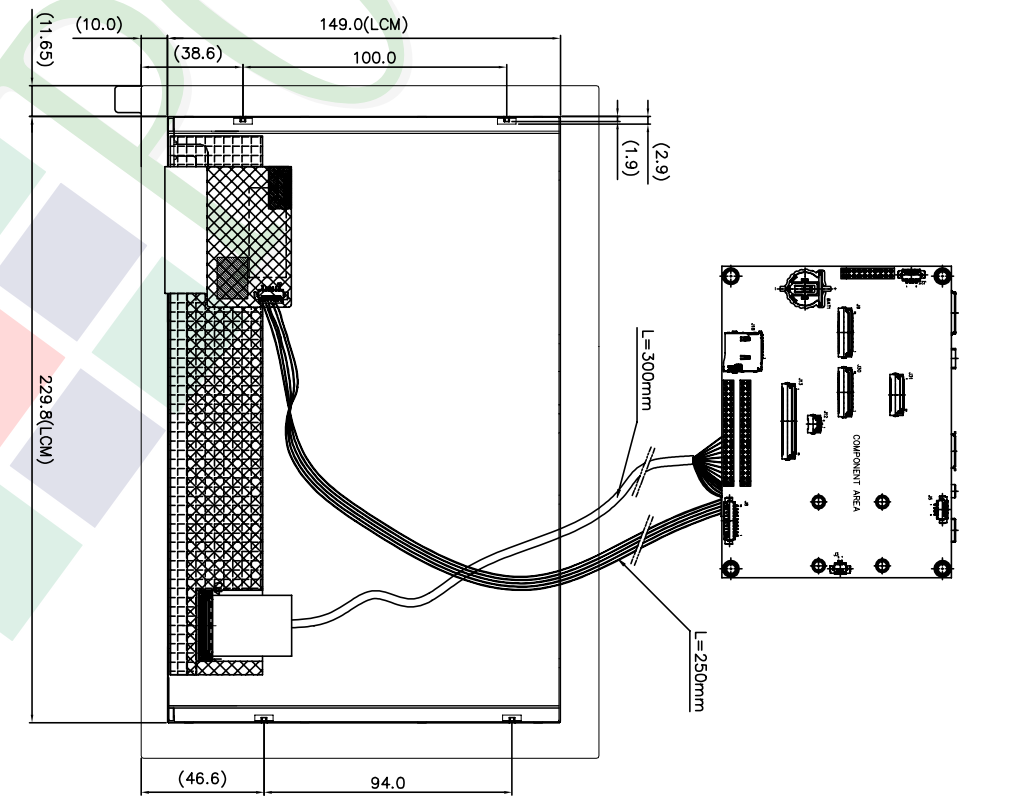
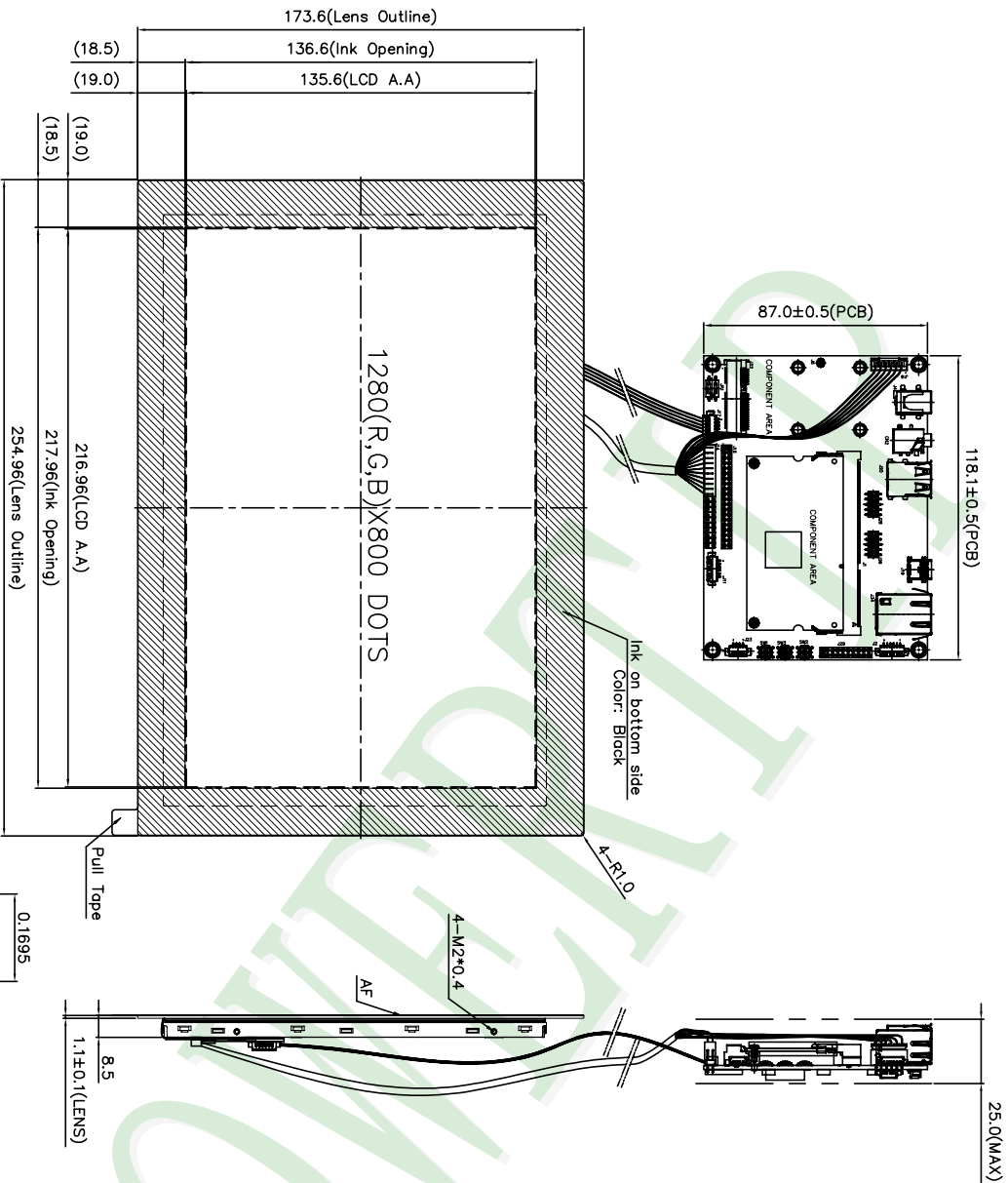

DOTS DETAIL
SCALE: 200X

- NOTES:
- 1.LCD TYPE: TFT LCD
 - 2.LCD DISPLAY: POSITIVE/TRANSMISSIVE
 - 3.VIEW DIRECTION: Full Viewing Angle
 4. The tolerance unless classified ±0.3mm

007				
006				
005				
004				
003				
002	REMOVE J7 - J10 - J27	Nini	2021/12/14	
001	NEW DRAWING	Nini	2021/05/05	
REV	REV BY	REVISER	DATE	

PART NO:	HRA128800T004ZZC06
DRAWING NAME:	LMD-HRA128800T004ZZC06
TITLE:	LCD MODULE DRAWING

Design	Nini Chen
Check	Mares Lu
Approve	Daniel Lin

久正光電股份有限公司
POWER TIP TECHNOLOGY CORPORATION

Unit	MM	Surface	(3)	Level	-
Scale	FIT	Material			-
Page	1/2	Thickness			-
Quantity		Quantity			-
					250 ~ 1000

Approve	Check	Contact
Marcs	Bright	Nini

1. 包裝材料規格表 (Packaging Material) : (per carton)

No.	Item	Model	Dimensions (mm)	1Pcs Weight	Quantity	Total Weight
1	模組 (LCM)	PH128800T004-ZZC06	254.96 X 173.6 X 8.5	0.42	3	1.26
2	紙內襯 (1)Lined with paper	BX00000000136	538 X 384	0.13	3	0.39
3	抗靜電袋(2)Antistatic Bag	BAG0000000021	240 X 300	0.008	3	0.024
4	舒美墊(3) EPE	FOAM000000047	350 X 255 X 5	0.011	3	0.033
5	內盒(4)Product Box	BX00000000135	458 X 300 X 62	0.31	3	0.93
6	抗靜電袋(5)Antistatic Bag	BAG350120ARABA	120X 350	0.005	3	0.015
7	線材(CABLE A)	CB00000000196	L=400mm	0.011	3	0.033
8	抗靜電袋(6)Antistatic Bag	BAG150120ARABA	150 X 120	0.003	3	0.009
9	系統板(SBC Board)	—————	87 X 118.1X21.5	0.083	3	0.249
10	抗靜電夾鏈袋(7)Antistatic Zipper Bag	BAG0000000050	90X130	0.007	3	0.021
11	線材(CABLE B)	CB00000000201	L=250mm	0.003	3	0.009
12	銅柱(Stand)	OTSPACER00024	φ 4.5X 6.7	0.0007	6	0.0042
13	紙內襯 (8)Lined with paper	BX00000000137	516 X 367	0.043	3	0.129
14	舒美墊(9) EPE	OTFOAMEP0003BA	333 X 218 X 10	0.02	2	0.04
15	保利龍板(10)Poylon board	OTPLB00PL10ABA	440 X 320 X 5	0.01	3	0.03
16	外紙箱(11)Carton	BX47334524CCBA	473X 345 X 240	1.3	1	1.3

2. 一整箱總重量 (Total LCD Weight in carton) : 4.48 Kg±10%

3. 單箱數量規格表 (Packaging Specifications and Quantity) :

(1)LCM quantity per small box : no per lined with paper	1	x	no of small box	1	=	1
(2)Total LCM quantity in carton : quantity per big box	1	x	no of cartons	3	=	3

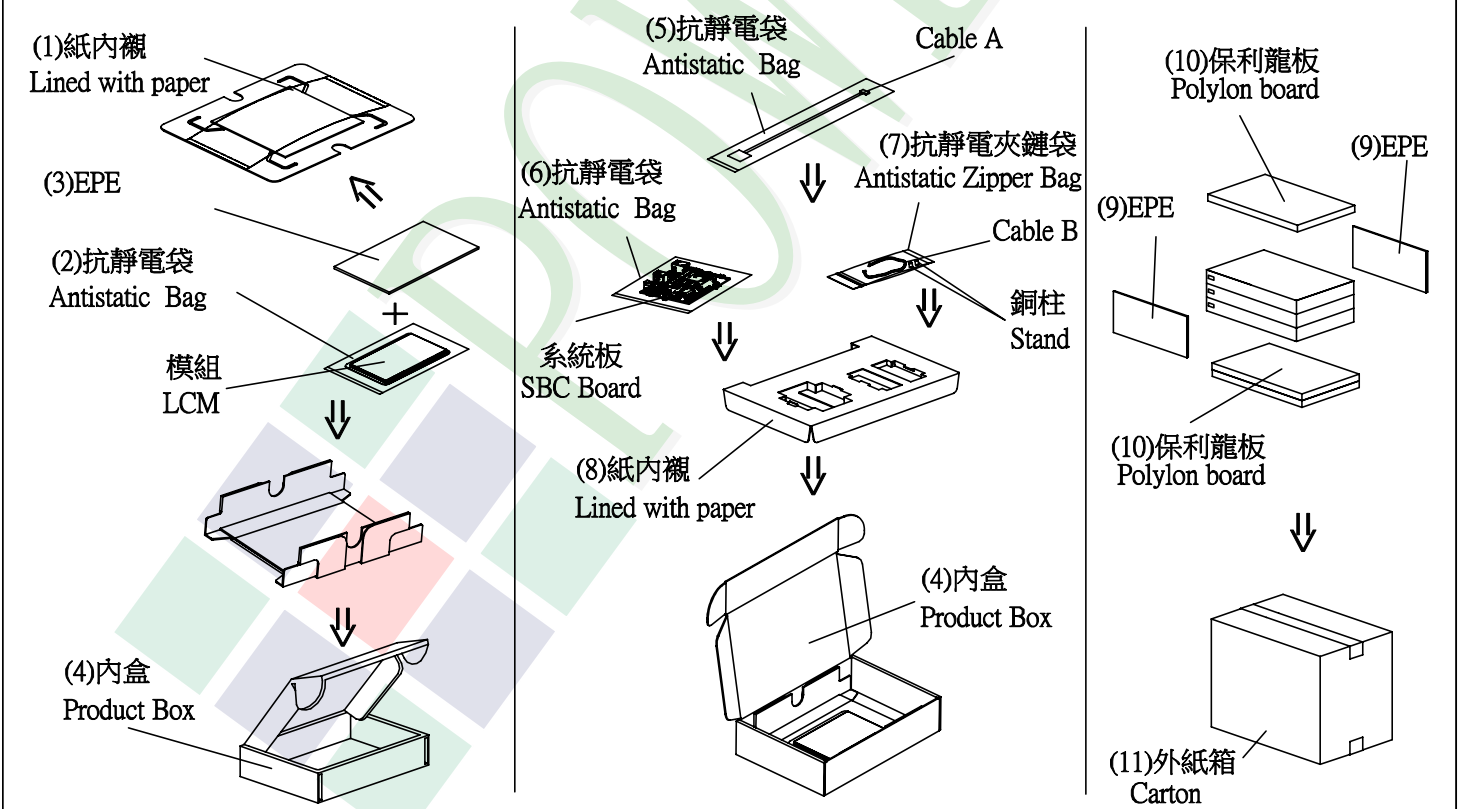

特 記 事 項 (REMARK)

--	--	--

HRA128800T004ZZC06 Assembly Guide (TOP)

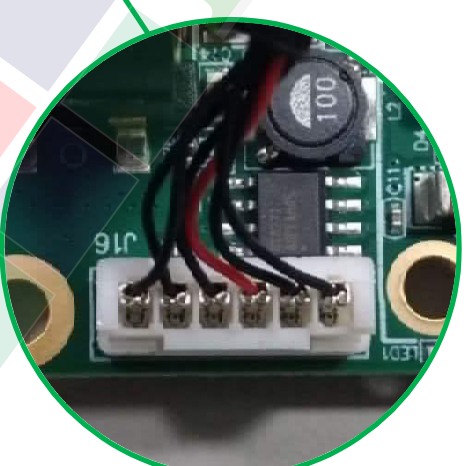
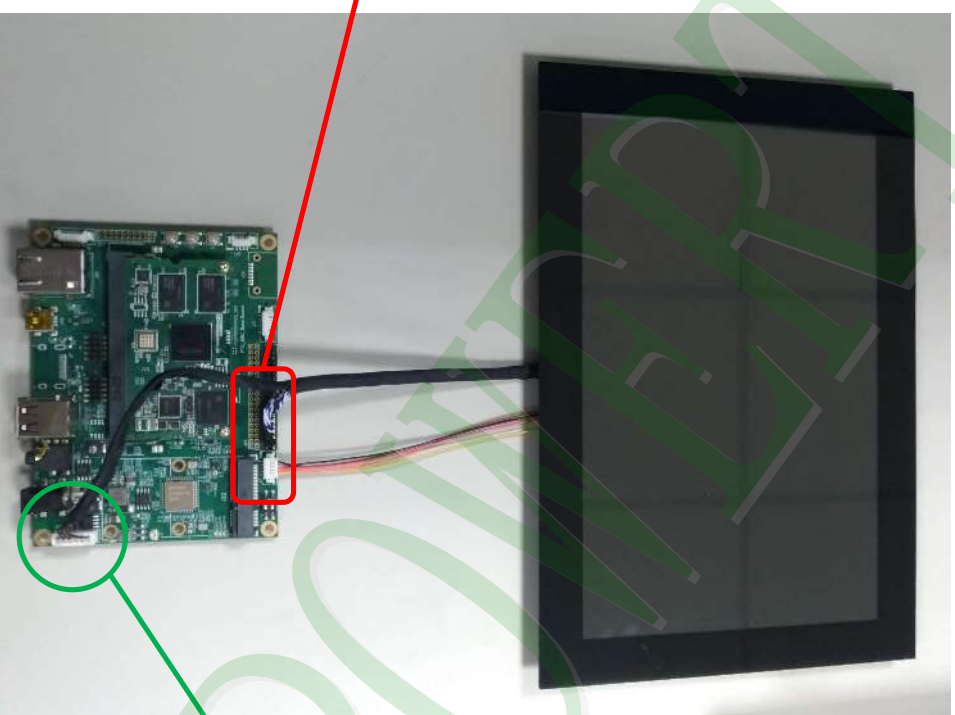

HRA128800T004ZZC06 Assembly Guide (BOTTOM)

