

OLIVIA-S

~20° spot beam

TECHNICAL SPECIFICATIONS:

Dimensions	Ø 70.0 mm
Height	22.6 mm
Fastening	screw
ROHS compliant	yes ⓘ

MATERIAL SPECIFICATIONS:

Component	Type	Material	Colour	Finish
OLIVIA-S	Single lens	PC		
OLIVIA-HLD	Holder	PC		



ORDERING INFORMATION:

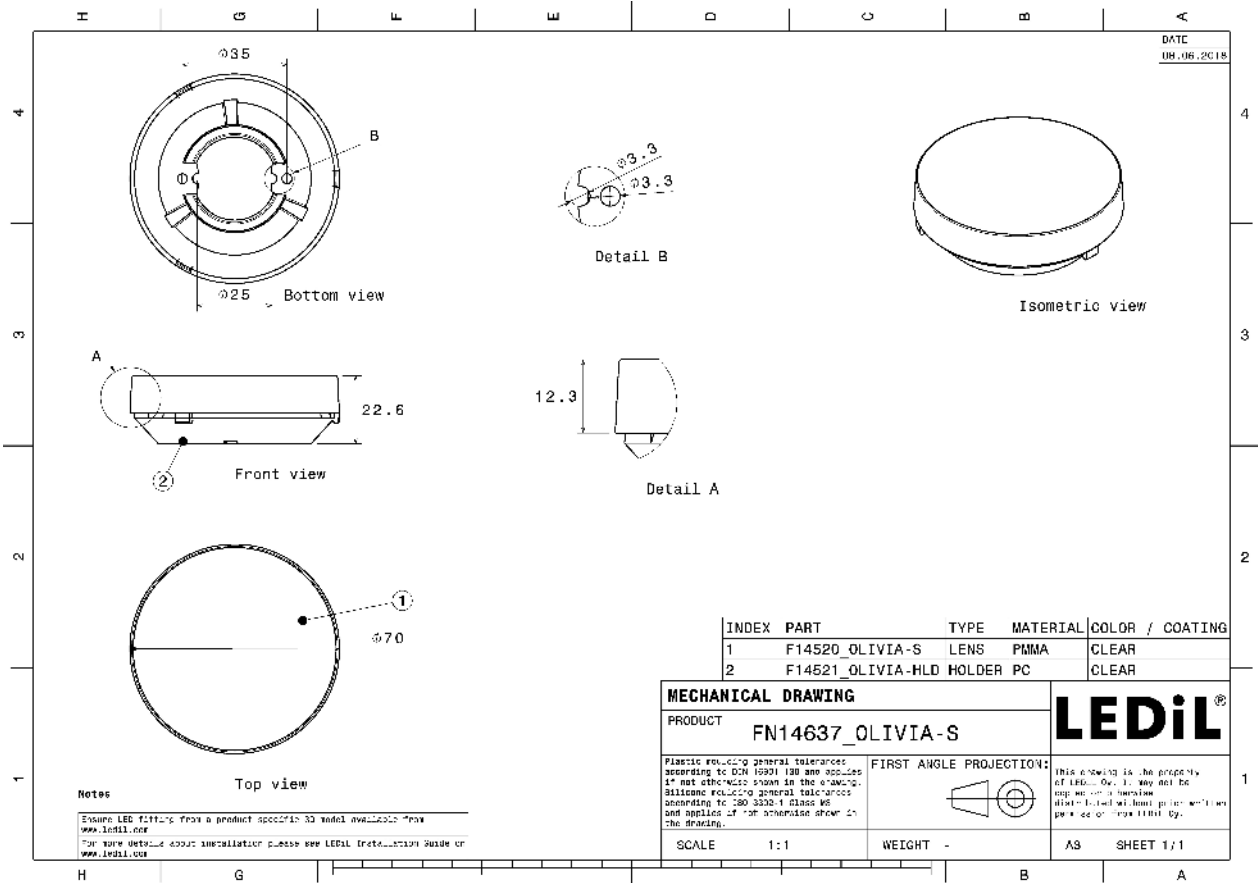

Component		Qty in box	MOQ	MPQ	Box weight (kg)
FN14637_OLIVIA-S	Single lens		140	20	0.0
» Box size:					



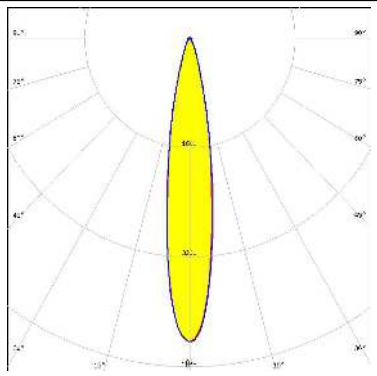
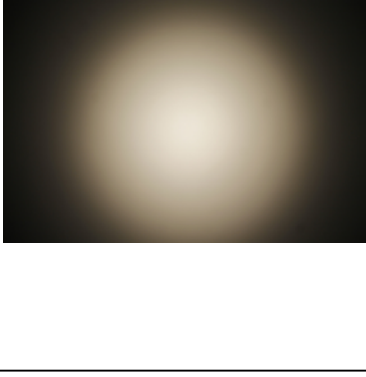
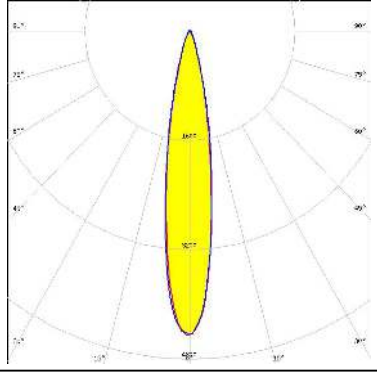
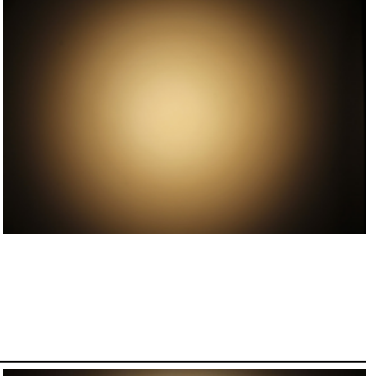
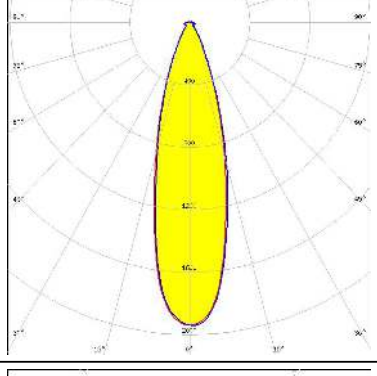
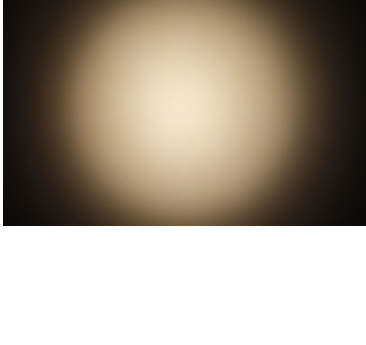
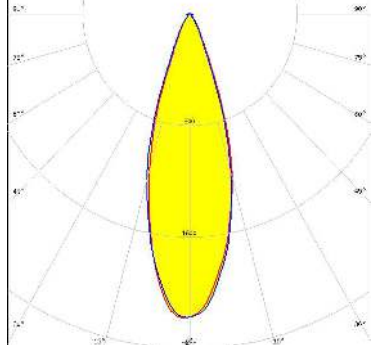

PHOTOMETRIC DATA (MEASURED):

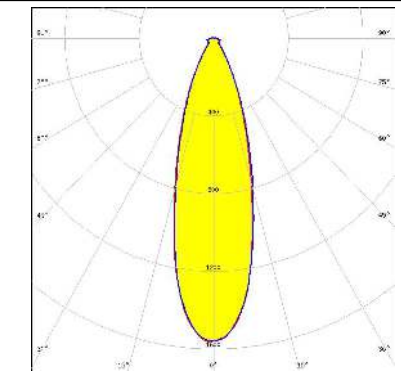
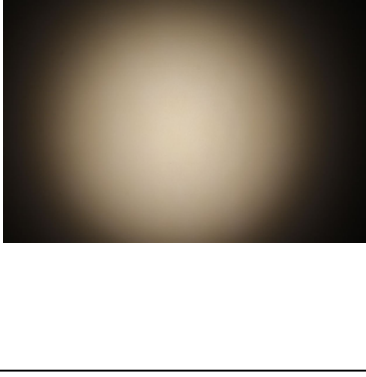
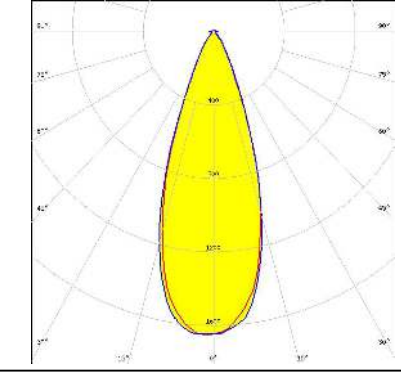
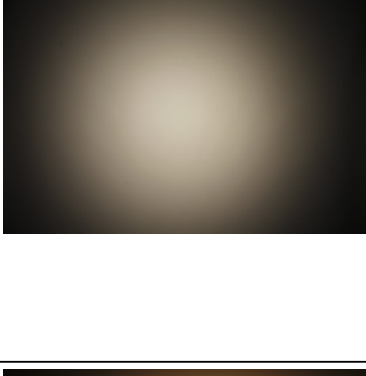
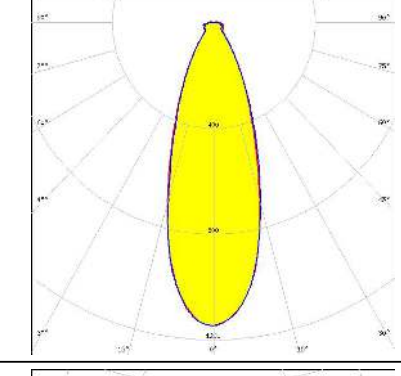
<p>bridgelux.</p> <p>LED V10 Gen6 FWHM 18.0° Efficiency 75 % Peak intensity 4.400 cd/lm LEDs/each optic 1 Light colour White Required components: BJB: 47.319.6214</p>		
<p>bridgelux.</p> <p>LED V10 Gen7 FWHM 18.0° Efficiency 75 % Peak intensity 4.500 cd/lm LEDs/each optic 1 Light colour White Required components: BJB: 47.319.6060</p>		
<p>bridgelux.</p> <p>LED V15 Gen6 FWHM 28.0° Efficiency 74 % Peak intensity 1.900 cd/lm LEDs/each optic 1 Light colour White Required components: BJB: 47.319.2224</p>		
<p>bridgelux.</p> <p>LED V15 Gen6 FWHM 32.0° Efficiency 79 % Peak intensity 2.200 cd/lm LEDs/each optic 1 Light colour White Required components:</p>		

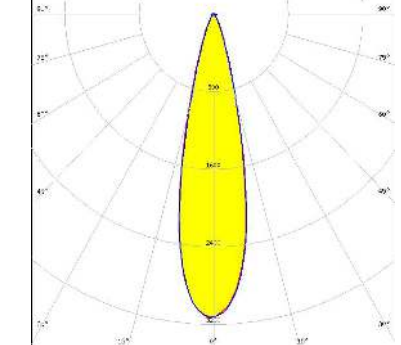
PHOTOMETRIC DATA (MEASURED):

<p>bridgelux.</p> <p>LED V18 Gen6 FWHM 31.0° Efficiency 73 % Peak intensity 1.600 cd/lm LEDs/each optic 1 Light colour White Required components: BJB: 47.319.2274</p>		
<p>bridgelux.</p> <p>LED V18 Gen6 FWHM 37.0° Efficiency 78 % Peak intensity 1.700 cd/lm LEDs/each optic 1 Light colour White Required components:</p>		
<p>bridgelux.</p> <p>LED V22 Gen6 FWHM 35.0° Efficiency 71 % Peak intensity 1.100 cd/lm LEDs/each optic 1 Light colour White Required components: A.A.G. STUCCHI: 8102/G2</p>		
<p>bridgelux.</p> <p>LED Vero SE 13 FWHM 24.0° Efficiency 77 % Peak intensity 3.100 cd/lm LEDs/each optic 1 Light colour White Required components:</p>		

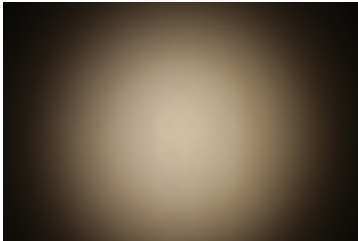
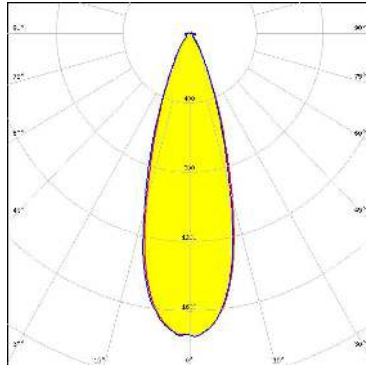
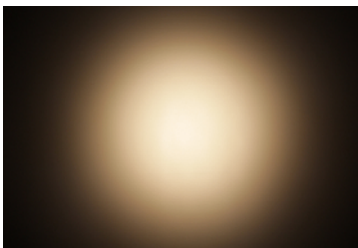
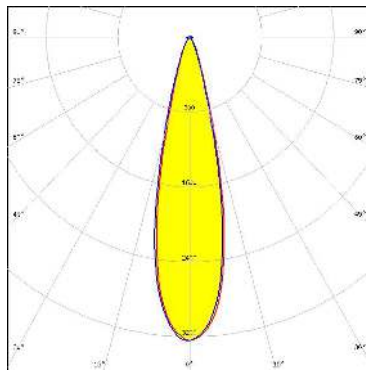
PHOTOMETRIC DATA (MEASURED):

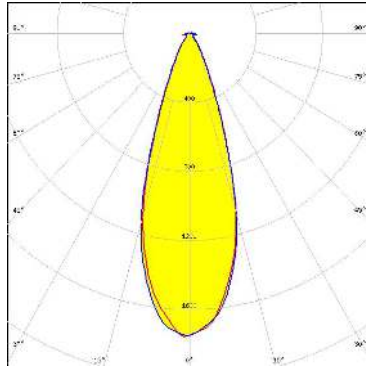
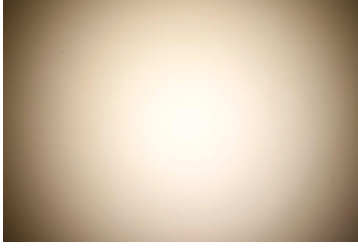
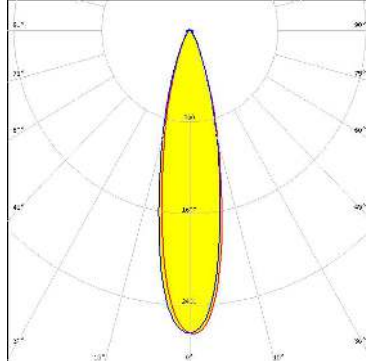
<p>bridgelux.</p> <p>LED Vero SE 18 FWHM 33.0° Efficiency 76 % Peak intensity 1.800 cd/lm LEDs/each optic 1 Light colour White Required components:</p>		
<p>bridgelux.</p> <p>LED Xenio Point 13mm FWHM 25.0° Efficiency 80 % Peak intensity 3.240 cd/lm LEDs/each optic 1 Light colour White Required components:</p>		
<p>bridgelux.</p> <p>LED Xenio Point 18mm FWHM 35.0° Efficiency 79 % Peak intensity 1.760 cd/lm LEDs/each optic 1 Light colour White Required components:</p>		
<p>CITIZEN</p> <p>LED CLL03x/CLU03x FWHM 23.0° Efficiency 76 % Peak intensity 2.700 cd/lm LEDs/each optic 1 Light colour White Required components: A.A.G. STUCCHI: 8101/G2</p>		

PHOTOMETRIC DATA (MEASURED):

CITIZEN

LED CLL03x/CLU03x
FWHM 26.0°
Efficiency 76 %
Peak intensity 2.400 cd/lm
LEDs/each optic 1
Light colour White
Required components:
A.A.G. STUCCHI: 8101/G2

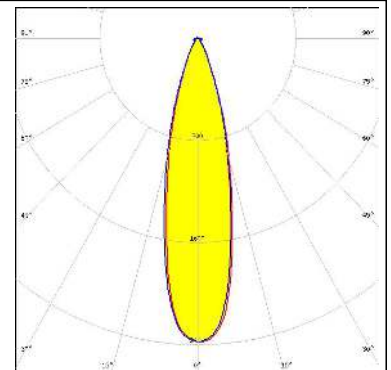
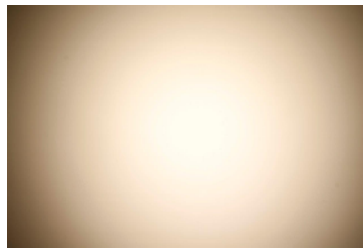

CITIZEN

LED CLU700/701/702
FWHM 14.0°
Efficiency 75 %
Peak intensity 7.000 cd/lm
LEDs/each optic 1
Light colour White
Required components:
A.A.G. STUCCHI: 8100/G2

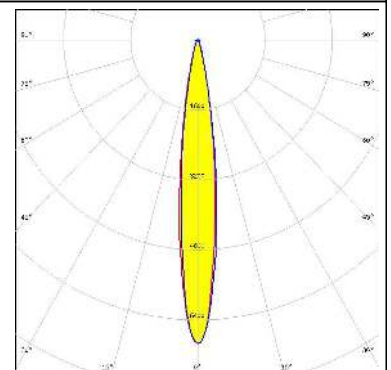
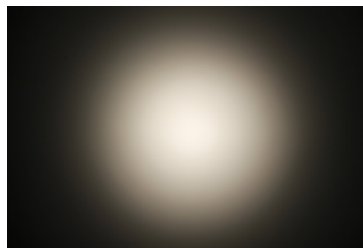

CITIZEN

LED CLU700/701/702
FWHM 19.0°
Efficiency 74 %
Peak intensity 4.400 cd/lm
LEDs/each optic 1
Light colour White
Required components:
BJB: 47.319.6060

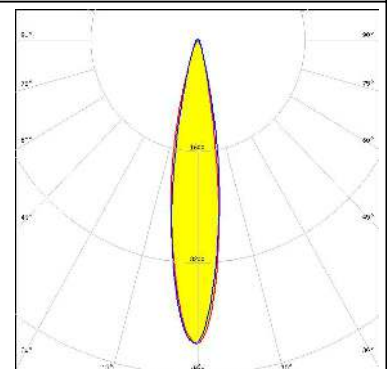
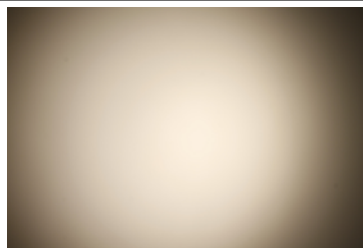

CITIZEN

LED CLU720/721
FWHM 20.0°
Efficiency 74 %
Peak intensity 3.300 cd/lm
LEDs/each optic 1
Light colour White
Required components:
TE: 2213254-2

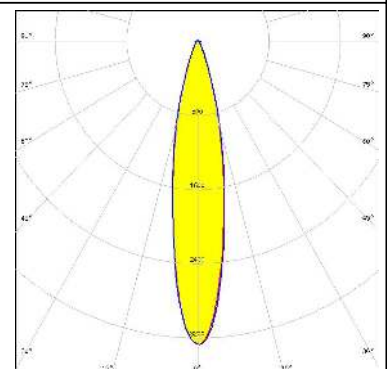
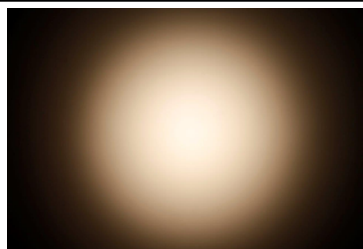

PHOTOMETRIC DATA (MEASURED):

CITIZEN

LED CLU720/721
 FWHM 21.0°
 Efficiency 74 %
 Peak intensity 3.200 cd/lm
 LEDs/each optic 1
 Light colour White
 Required components:
 BJB: 47.319.2021

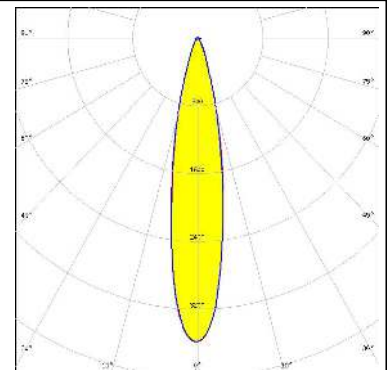

CITIZEN

LED CLU720/721
 FWHM 20.0°
 Efficiency 76 %
 Peak intensity 3.600 cd/lm
 LEDs/each optic 1
 Light colour White
 Required components:
 A.A.G. STUCCHI: 8101/G2

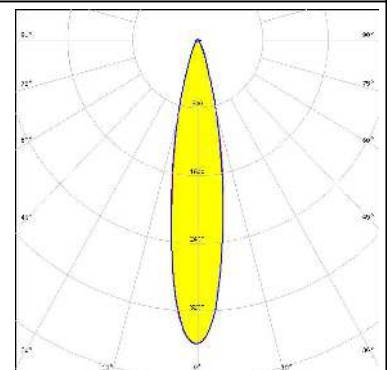
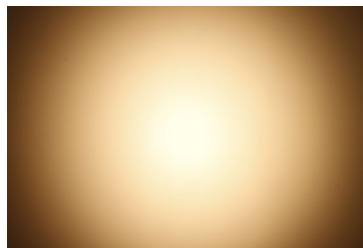

CREE

LED CXA/B 13xx
 FWHM 14.0°
 Efficiency 74 %
 Peak intensity 7.000 cd/lm
 LEDs/each optic 1
 Light colour White
 Required components:
 BJB: 47.319.6120

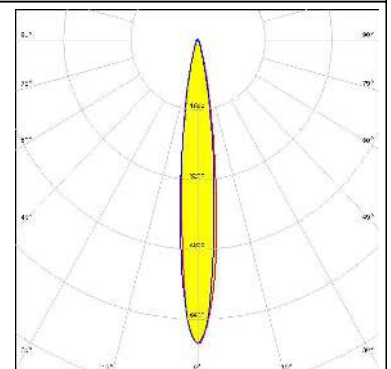
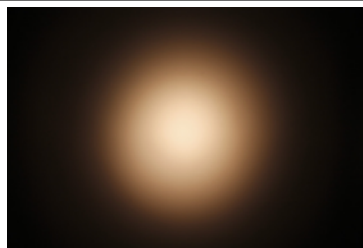

CREE

LED CXA/B 1816 & CXA/B 1820 & CXA 1850
 FWHM 21.0°
 Efficiency 76 %
 Peak intensity 3.300 cd/lm
 LEDs/each optic 1
 Light colour White
 Required components:
 BJB: 47.319.2131

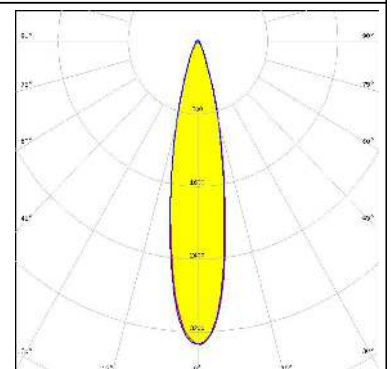
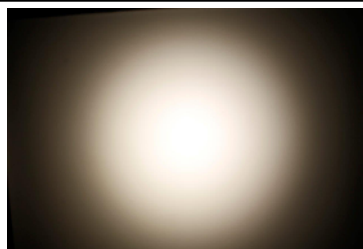

PHOTOMETRIC DATA (MEASURED):



LED CXA/B 25xx
 FWHM 29.0°
 Efficiency 74 %
 Peak intensity 1.700 cd/lm
 LEDs/each optic 1
 Light colour White
 Required components:
 A.A.G. STUCCHI: 8401/G2

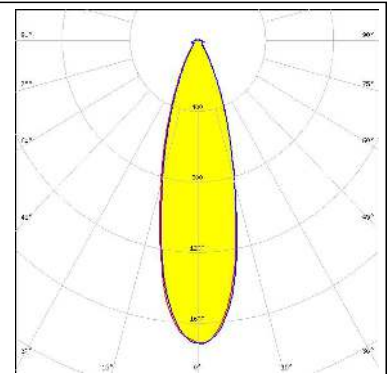
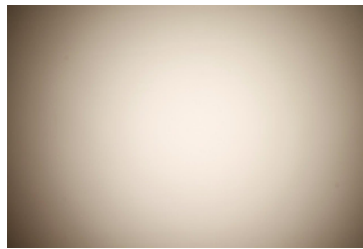

LED CXA/B 25xx
 FWHM 29.0°
 Efficiency 73 %
 Peak intensity 1.600 cd/lm
 LEDs/each optic 1
 Light colour White
 Required components:
 TE: 2213407-2

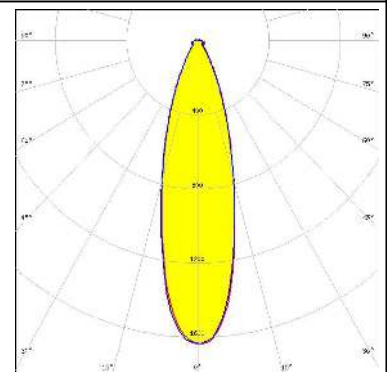
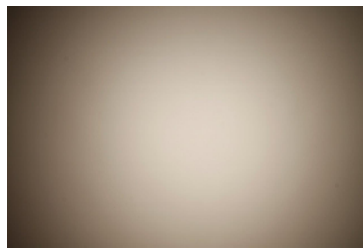

LED CXA/B 25xx
 FWHM 29.0°
 Efficiency 74 %
 Peak intensity 1.700 cd/lm
 LEDs/each optic 1
 Light colour White
 Required components:
 BJB: 47.319.2040

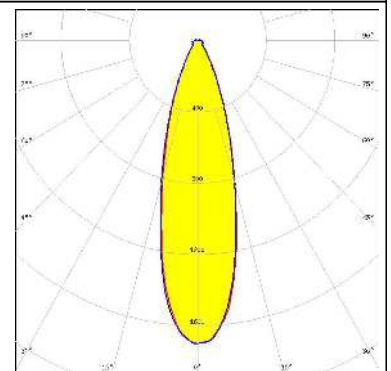
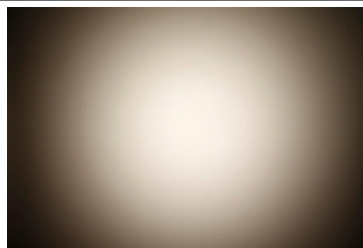

LED LUXEON CoB 1204/1205
 FWHM 26.0°
 Efficiency 77 %
 Peak intensity 3.100 cd/lm
 LEDs/each optic 1
 Light colour White
 Required components:
 Bender Wirth: 432 Typ Z1

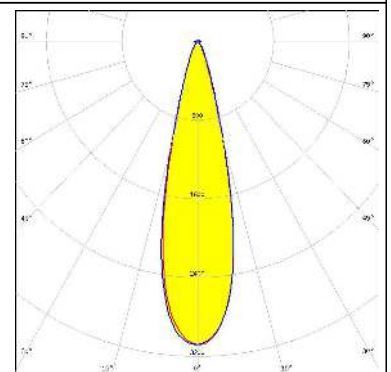
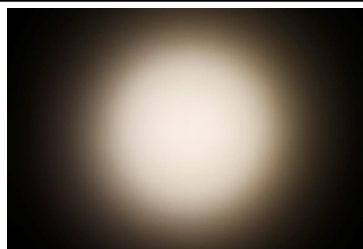

PHOTOMETRIC DATA (MEASURED):

LUMILEDS

LED LUXEON CoB 1204/1205
 FWHM 23.0°
 Efficiency 76 %
 Peak intensity 2.800 cd/lm
 LEDs/each optic 1
 Light colour White
 Required components:
 A.A.G. STUCCHI: 8301/G2

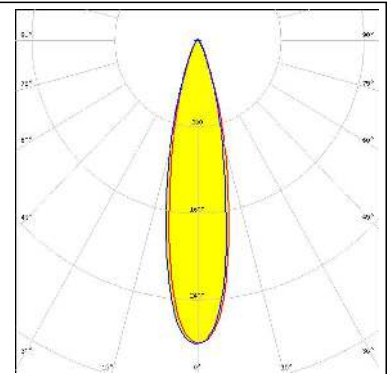
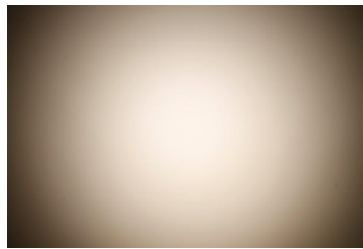

LUMILEDS

LED LUXEON CoB 1208
 FWHM 27.0°
 Efficiency 74 %
 Peak intensity 2.100 cd/lm
 LEDs/each optic 1
 Light colour White
 Required components:
 A.A.G. STUCCHI: 8301/G2

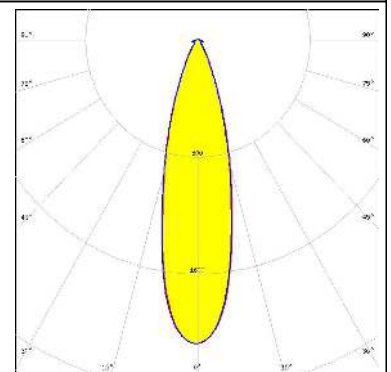
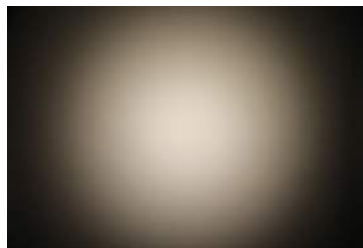

LUMILEDS

LED LUXEON CoB 1208
 FWHM 29.0°
 Efficiency 77 %
 Peak intensity 2.400 cd/lm
 LEDs/each optic 1
 Light colour White
 Required components:
 Bender Wirth: 432 Typ Z1

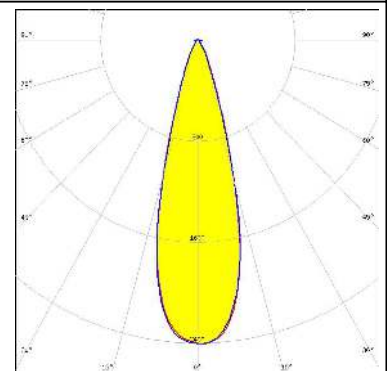
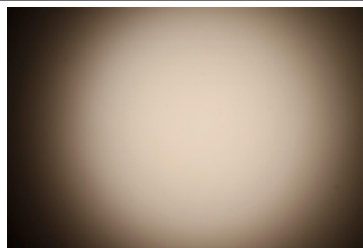

LUMILEDS

LED LUXEON CoB 1211
 FWHM 32.0°
 Efficiency 73 %
 Peak intensity 1.480 cd/lm
 LEDs/each optic 1
 Light colour White
 Required components:
 BJB: 47.319.2030

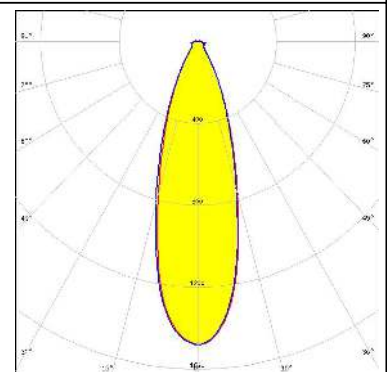
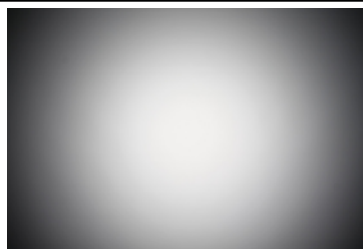

PHOTOMETRIC DATA (MEASURED):

LUMILEDS

LED LUXEON CoB 1216/1812
 FWHM 37.0°
 Efficiency 71 %
 Peak intensity 1.080 cd/lm
 LEDs/each optic 1
 Light colour White
 Required components:
 BJB: 47.319.2030

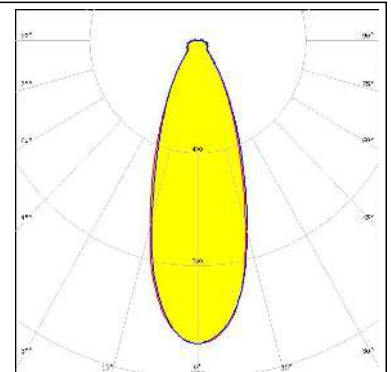
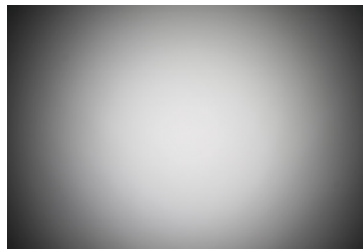

LUMILEDS

LED LUXEON CoB Compact
 FWHM 15.0°
 Efficiency 75 %
 Peak intensity 6.100 cd/lm
 LEDs/each optic 1
 Light colour White
 Required components:
 BJB: 47.319.6180

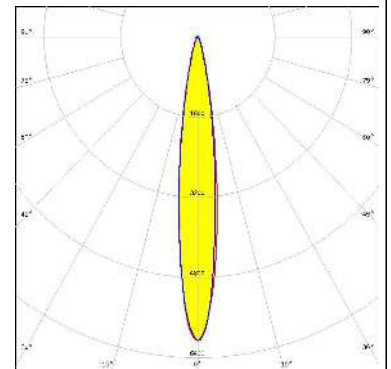
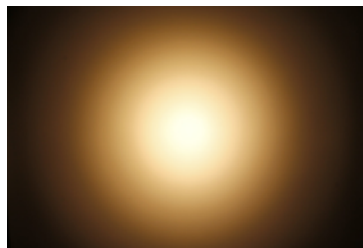

PHILIPS

LED Fortimo SLM L09 + SLM holder (PI)
 FWHM 18.0°
 Efficiency 78 %
 Peak intensity 4.950 cd/lm
 LEDs/each optic 1
 Light colour White
 Required components:

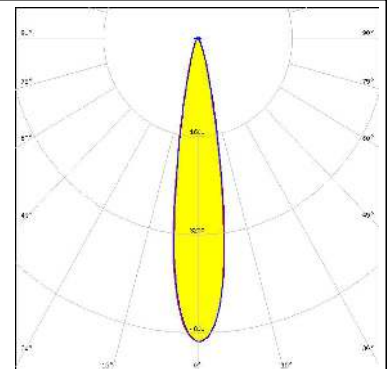
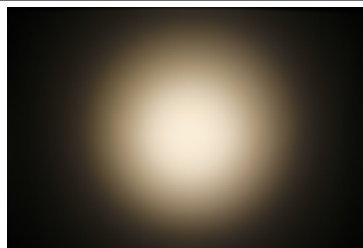

PHILIPS

LED Fortimo SLM L13 + SLM holder (PI)
 FWHM 25.0°
 Efficiency 76 %
 Peak intensity 2.820 cd/lm
 LEDs/each optic 1
 Light colour White
 Required components:

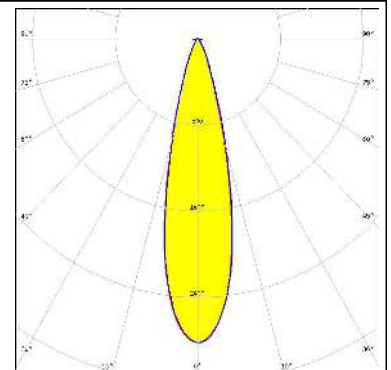
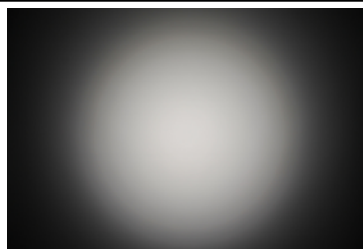

PHOTOMETRIC DATA (MEASURED):

PHILIPS

LED Fortimo SLM L15 + SLM holder (PI)
 FWHM 28.0°
 Efficiency 76 %
 Peak intensity 2.230 cd/lm
 LEDs/each optic 1
 Light colour White
 Required components:

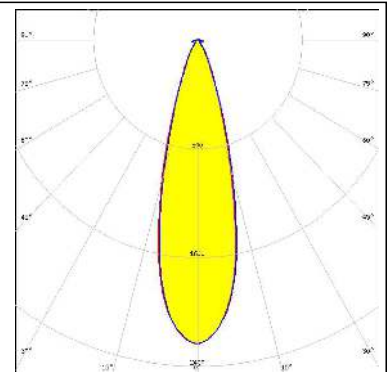
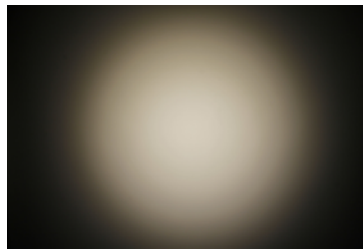

PHILIPS

LED Fortimo SLM L19 + SLM holder (PI)
 FWHM 35.0°
 Efficiency 75 %
 Peak intensity 1.500 cd/lm
 LEDs/each optic 1
 Light colour White
 Required components:

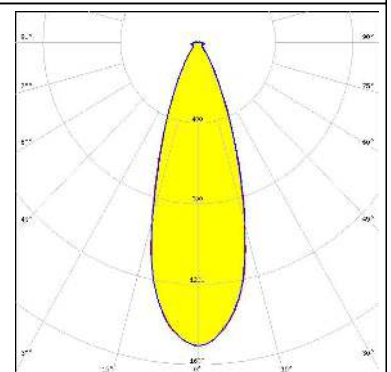
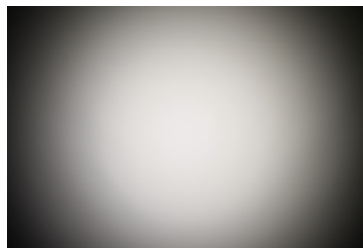

PHILIPS

LED Fortimo SLM L23 CoB
 FWHM 39.0°
 Efficiency 72 %
 Peak intensity 1.100 cd/lm
 LEDs/each optic 1
 Light colour White
 Required components:

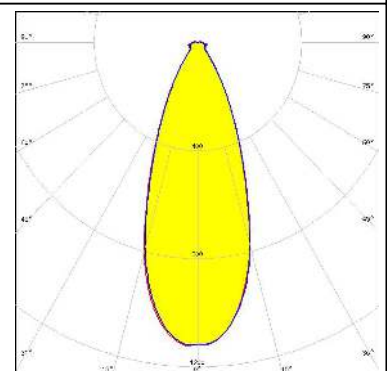
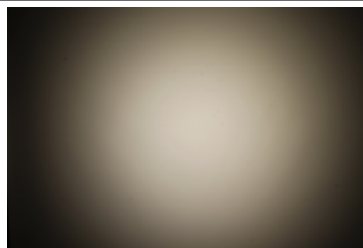

SAMSUNG

LED COB D Series LES 14.5 mm
 FWHM 26.0°
 Efficiency 76 %
 Peak intensity 2.220 cd/lm
 LEDs/each optic 1
 Light colour White
 Required components:
 BJB: 47.319.2021

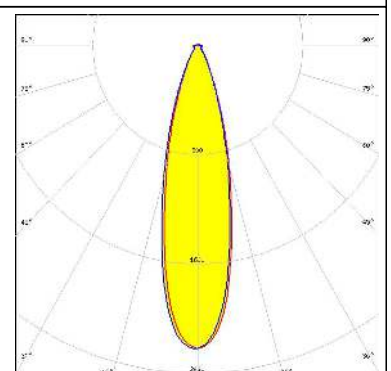
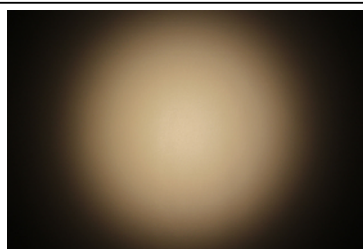

PHOTOMETRIC DATA (MEASURED):

SAMSUNG

LED COB D Series LES 14.5 mm
 FWHM 26.0°
 Efficiency 76 %
 Peak intensity 2.220 cd/lm
 LEDs/each optic 1
 Light colour White
 Required components:
 A.A.G. STUCCHI: 8101/G2

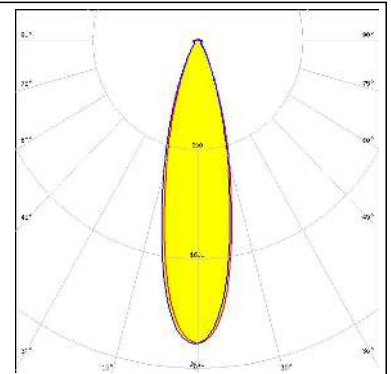

SAMSUNG

LED COB D Series LES 9.8 mm
 FWHM 18.0°
 Efficiency 77 %
 Peak intensity 4.400 cd/lm
 LEDs/each optic 1
 Light colour White
 Required components:
 A.A.G. STUCCHI: 8100/G2

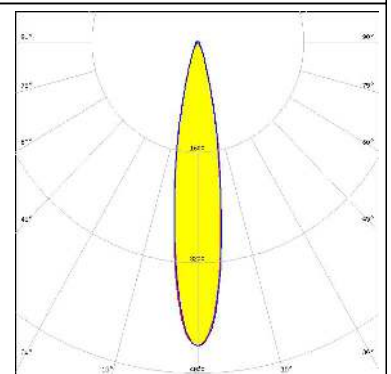
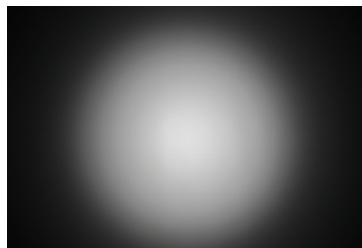

SAMSUNG

LED COB D Series LES 9.8 mm
 FWHM 18.0°
 Efficiency 77 %
 Peak intensity 4.400 cd/lm
 LEDs/each optic 1
 Light colour White
 Required components:
 BJB: 47.319.6060

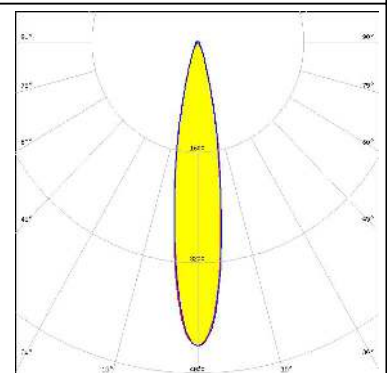
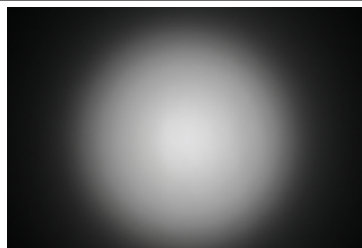

SAMSUNG

LED SLE-013
 FWHM 21.0°
 Efficiency 75 %
 Peak intensity 3.100 cd/lm
 LEDs/each optic 1
 Light colour White
 Required components:

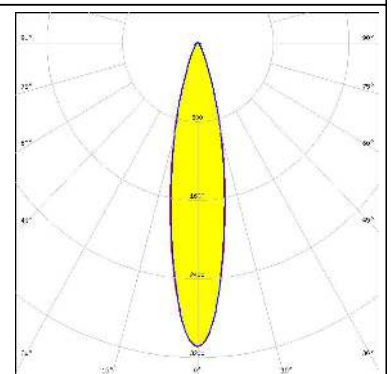
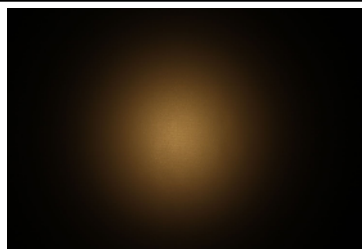

PHOTOMETRIC DATA (MEASURED):

SAMSUNG

LED SLE-026/033/040
FWHM 29.0°
Efficiency 74 %
Peak intensity 1.740 cd/lm
LEDs/each optic 1
Light colour White
Required components:

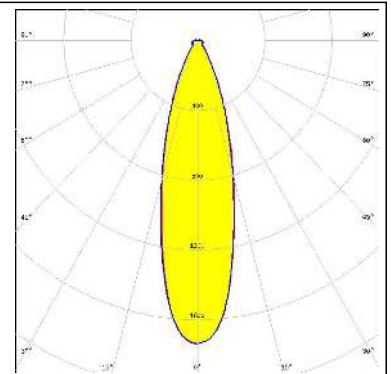
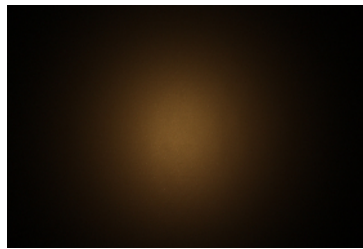

SHARP



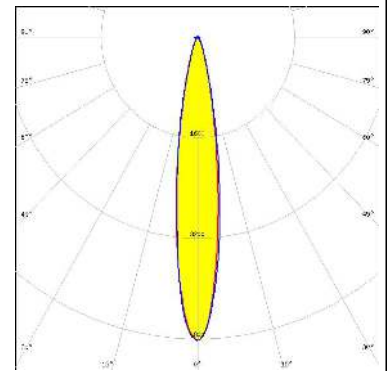
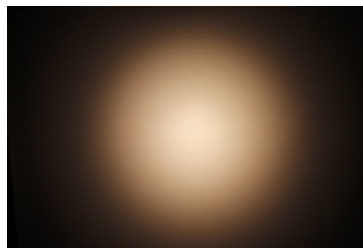

LED Mini Zenigata (GW6BM)
FWHM 17.0°
Efficiency 75 %
Peak intensity 4.800 cd/lm
LEDs/each optic 1
Light colour White
Required components:
BJB: 47.319.6180

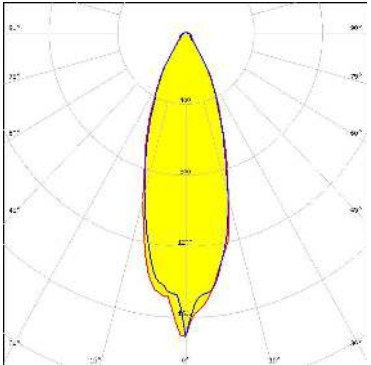
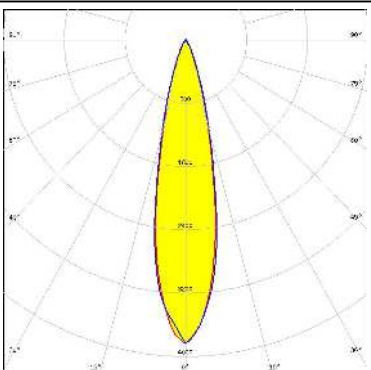

PHOTOMETRIC DATA (SIMULATED):

<p>bridgelux.</p> <p>LED V13 Gen7 FWHM 26.0° Efficiency 93 % Peak intensity 3.200 cd/lm LEDs/each optic 1 Light colour White Required components: BJB: 47.319.2021</p>	
<p>bridgelux.</p> <p>LED V13 Gen7 FWHM 26.0° Efficiency 95 % Peak intensity 3.750 cd/lm LEDs/each optic 1 Light colour White Required components: Bender Wirth: 477 Typ L1</p>	
<p>bridgelux.</p> <p>LED V13 Gen7 FWHM 24.0° Efficiency 91 % Peak intensity 3.240 cd/lm LEDs/each optic 1 Light colour White Required components: TE: 2213254-2</p>	
<p>bridgelux.</p> <p>LED V13 Gen7 FWHM 26.0° Efficiency 94 % Peak intensity 3.660 cd/lm LEDs/each optic 1 Light colour White Required components: TE: 2213254-1</p>	

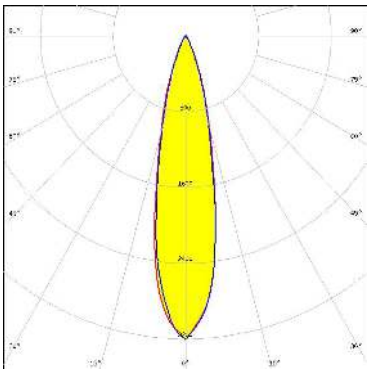
PHOTOMETRIC DATA (SIMULATED):

<p> LED V22 Gen7 FWHM 32.0° Efficiency 85 % Peak intensity 1.726 cd/lm LEDs/each optic 1 Light colour White Required components: BJB: 47.319.2030</p>	
<p>CITIZEN LED CLL03x/CLU03x FWHM 23.0° Efficiency 81 % Peak intensity 3.840 cd/lm LEDs/each optic 1 Light colour White Required components: BJB: 47.319.2021</p>	
<p> LED LUXEON CoB 1204/1205 FWHM 23.0° Efficiency 72 % Peak intensity 3.530 cd/lm LEDs/each optic 1 Light colour White Required components: TE: 2213130-2</p>	
<p>SHARP LED Mega Zenigata (GW6DME) FWHM 29.0° Efficiency 77 % Peak intensity 2.400 cd/lm LEDs/each optic 1 Light colour White Required components: Bender Wirth: 432 Typ Z1</p>	

GENERAL INFORMATION:

NOTE: The typical beam angle will be changed by different color, chip size and chip position tolerance. The typical total beam angle is the full angle measured where the luminous intensity is half of the peak value.

Due to use of high power COB's with this product, special attention to proper thermal design is highly recommended. LEDiL has no liability for direct, indirect or consecutive damages arising from the LEDiL products being used outside of the recommended temperature range.

MATERIALS:

As part of our continuous research and improvement processes, and to ensure the best possible quality and availability of our products, LEDiL reserves the right to change material grades without notice.

PRODUCT DATA USER AGREEMENT AND DISCLAIMER:

The measured data in the provided downloadable LEDiL Product Datasheets and Mechanical 2D-Drawings is rounded and provided as reference for planning. LEDiL Oy's optical specifications have been verified by conducting performance testing of the products in accordance with the company's quality system. The reported data are averaged results of multiple measurements with typical variation. LEDiL Oy reserves the right to without prior notification make changes and improvements to its products.

LEDiL Oy assumes neither warranty, nor guarantee nor any other liability of any kind for the contents and correctness of the provided data. The provided data has been generated with highest diligence but the provided data may in reality not represent the complete possible variation range of all intrinsic parameters. Therefore, in certain cases a deviation from the provided data could occur.

LEDiL Oy reserves the right to undertake technical changes of its products without further notification which could lead to changes in the provided data. LEDiL Oy assumes no liability of any kind for the possible deviation from any provided data or any other damage resulting from the usage of the provided data.

The user agrees to this disclaimer and user agreement with the download or usage of the provided files.

LEDiL Oy

Joensuunkatu 13
FI-24240 SALO
Finland

LEDiL Inc.

228 West Page Street
Suite D
Sycamore IL 60178
USA

Local sales and technical support

[www.ledil.com/
where_to_buy](http://www.ledil.com/where_to_buy)

Shipping locations

Salo, Finland
Hong Kong, China

Distribution Partners

[www.ledil.com/
where_to_buy](http://www.ledil.com/where_to_buy)