

This document is the property of Amphenol Aorora Corporation and is delivered on the express condition that it is not to be disclosed, reproduced or used, in whole or in part, for manufacture or sale by anyone other than Amphenol Aorora Corporation without its prior consent, & that no right is granted to disclose or to use any information in this document.

REV.	ECR/ECN No.	DESCRIPTION	DRAWN/DATE	CHECKED/DATE	APPROVED/DATE
A	/	New Version	May 2016-04-14	Rain 2016-04-14	Hongkui.liu 2016-04-14
B	/	Increase the control	May 2016-12-05	Rain 2016-12-05	Hongkui.liu 2016-12-05

NO.	COMPONENTS	MATERIALS	FINISH/COLOR SPECIFICATION	QUANTITY
1	Housing	GLASS FILLED LCP,UL94V-0	NATURAL	1
2	Contact	PHOSPHOR BRONZE, T=0.20±0.01mm	80u" MIN. TIN PLATING ALL	N

NOTE:

- 1.MATERIAL:
HOUSING:LCP.NATURAL.UL94V-0.
CONTACT:PHOSPHOR BRONZE;T=0.20mm.
- 2.PLATING:
CONTACT:80~160u" Matter Tin plating over all,
40~120u" Ni underplating over all
- 3."▽" NOTATION FOR CPK AND X-R TEST SIZE
- 4.COMPLIANT TO RoHS DIRECTIVE
2002/95/EC AND SONY SS-00259.
- 5.PART NO. LEGEND:
F52L-**7A1-110**-B*00

- 1:With Mylar
2:Without Mylar

7A:Matter Tin plating

1A:LCP NATURAL

①FA:LCP NATURAL(水口)

DIMENSION LIST:

NO.OF POS	NO.OF POS			NO.OF POS			
	A	B	C	A	B	C	
3	2.00	4.10	6.00	17	16.00	18.10	20.00
4	3.00	5.10	7.00	18	17.00	19.10	21.00
5	4.00	6.10	8.00	19	18.00	20.10	22.00
6	5.00	7.10	9.00	20	19.00	21.10	23.00
7	6.00	8.10	10.00	21	20.00	22.10	24.00
8	7.00	9.10	11.00	22	21.00	23.10	25.00
9	8.00	10.10	12.00	23	22.00	24.10	26.00
10	9.00	11.10	13.00	24	23.00	25.10	27.00
11	10.00	12.10	14.00	25	24.00	26.10	28.00
12	11.00	13.10	15.00	26	25.00	27.10	29.00
13	12.00	14.10	16.00	27	26.00	28.10	30.00
14	13.00	15.10	17.00	28	27.00	29.10	31.00
15	14.00	16.10	18.00	29	28.00	30.10	32.00
16	15.00	17.10	19.00	30	29.00	31.10	33.00

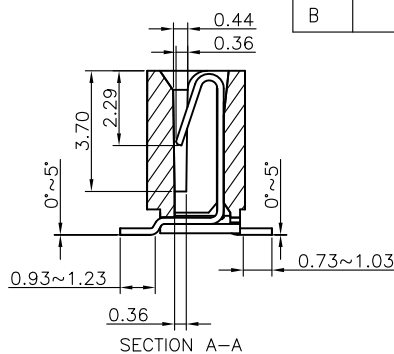
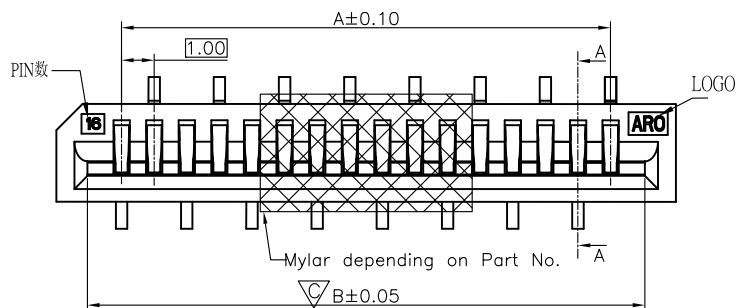

SECTION A-A

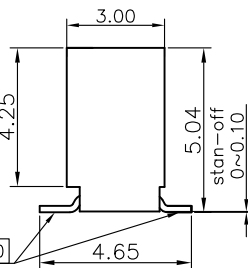
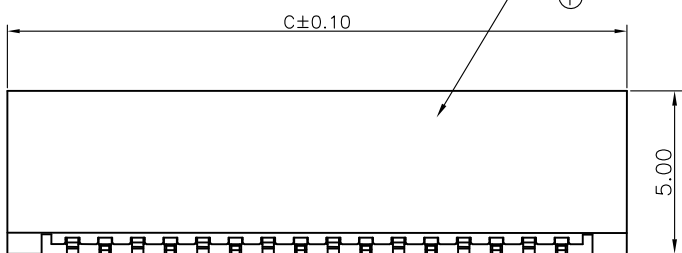

SUPPORTING TAPE

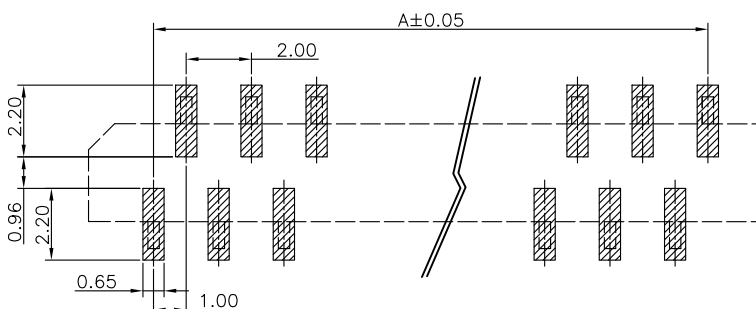
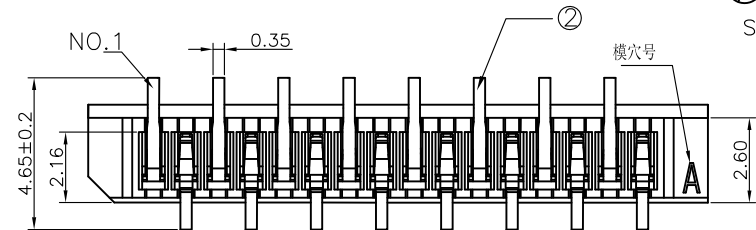

MOUNTING LAYOUT (CONN.MOUNTING SIDE)

KIND	TOLERANCE		
	P	W	M
FPC	±0.02	+0.10 -0.05	±0.05
FFC	±0.05	±0.03	±0.10

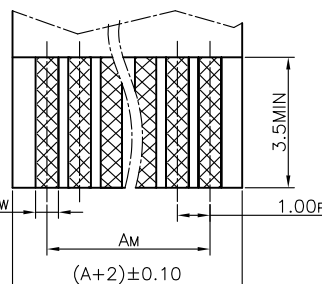

APPLICABLE FPC/FFC

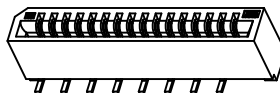

3D VIEW.

UNLESS OTHERWISE SPECIFIED TOLERANCES	
X. ±0.50	X. * ± 1'
X.X ±0.30	X.X * ± 0.5'
X.XX ±0.20	X.XX * ± 0.5'
X.XXX ±0.10	X.XXX * ± 1'
LINEAR DIMS	ANGLES DIMS
P/N: F52L-**7A1-110**-B*00	
MATERIAL	SEE NOTES
FINISHED	SEE NOTES

ANGLE OF PROJECTION

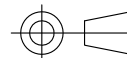

DOC TYPE	Customer Drw
DRAWN DATE	May 2016-12-05
DESIGN DATE	May 2016-12-05
CHECKED DATE	Rain 2016-12-05
APPROVED DATE	Hongkui.liu 2016-12-05



Amphenol Aorora Technology (Huizhou) Co.,Ltd

TITLE: FPC PITCH1.0mm NON-ZIF. SMT A TYPE

SIZE DWG NO. A4 A-S0289

SCALE 1:1 UNIT: mm SHEET 1 OF 1