

ICC80QSG 84 W AC-DC reference design #1 with IPN70R450P7S

For power tool battery charger with 230 V AC rated input and constant current (CC) output up to 4 A

About this document



Scope and purpose

This document is an engineering report for the 84 W AC-DC converter reference design #1 (orderable part number: REFICC80QSG84W1BPA), which uses Infineon's ICC80QSG flyback controller and **IPN70R450P7S** MOSFET.

This reference design board can be used for battery charging applications by adding externally both the battery safety switch and the charging profile control circuits. Please refer to the test setup and safety information section of this document for more information.

Intended audience

Power supply design engineers and field application engineers.

Table of contents

About this document	1
Table of contents	1
1 Test setup and safety information	2
2 Design features	4
3 Board specifications	5
4 Schematic and PCB layout	6
5 Performance	9
5.1 Efficiency.....	9
5.2 Standby power.....	10
5.3 Brown-in and brown-out protection.....	10
5.4 Thermal test.....	11
5.5 Conducted emissions (EN 55022 class B).....	12
6 Bill of materials and transformer specifications	13
6.1 BOM.....	13
6.2 Transformer specifications.....	16
Revision history	17

1 Test setup and safety information

This AC-DC reference design consists of a main board and a plug-in board, which are connected to form a flyback converter with secondary-side regulated (SSR) constant current (CC) output. The CC output set-point is adjustable with a 0 to 5 V analog input signal.

As shown in **Figure 1**, to use this reference design board for battery charging application testing, it is mandatory to add externally both the battery safety switch and the charging profile control circuits, which work according to the board and battery specification.

Attention: For safety reasons, it is prohibited to connect this reference design board to any battery without adding externally the battery safety switch and charging profile control circuits.

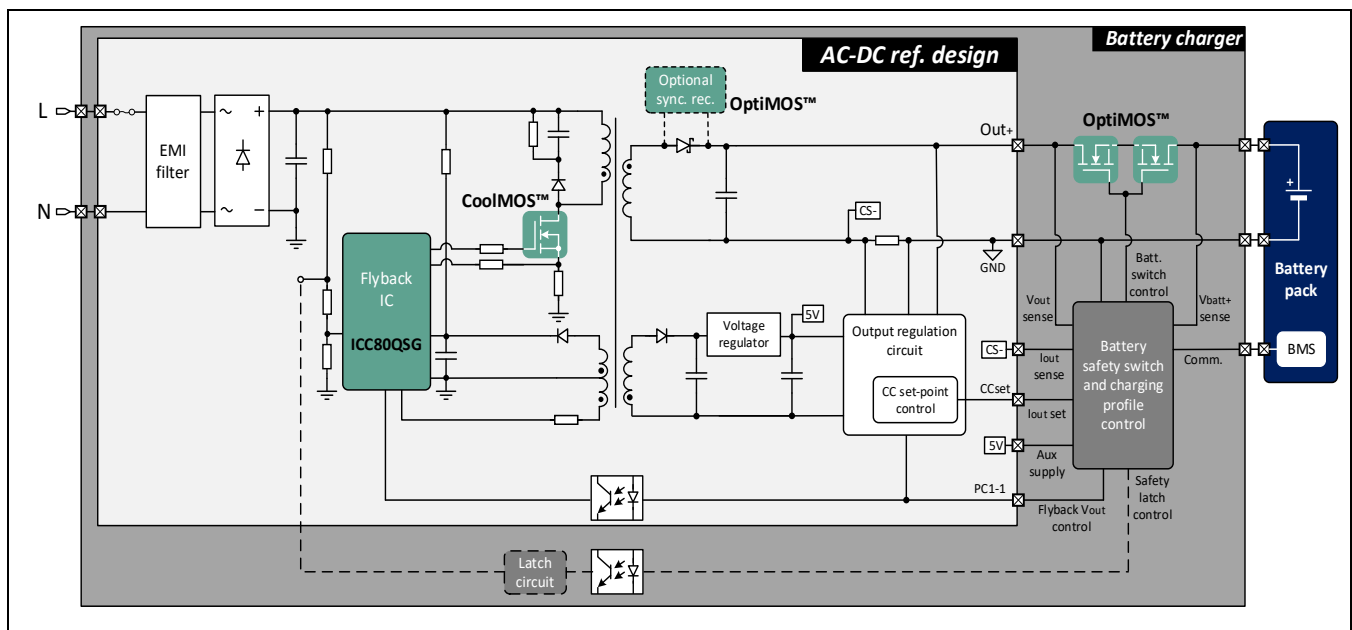

Figure 1 Test setup of AC-DC reference design with connections to external battery safety switch and charging profile control circuits, for battery charging application testing

Alternatively, a test setup using the electronic load (in constant voltage/CV mode) and DC source (for adjusting CC set-point) can be done based on **Figure 2**.

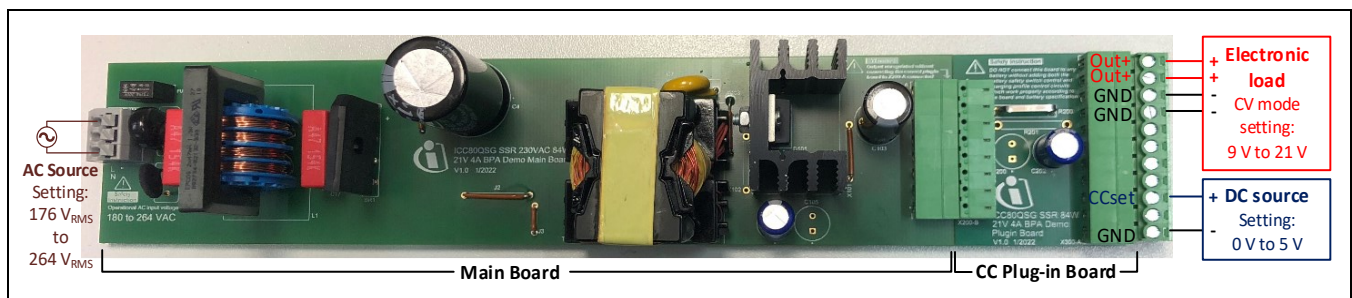

Figure 2 Test setup with electronic load and adjustable CC set-point using DC source

Attention: Lethal voltages are present on this reference design. Do not operate the board unless you are trained to handle HV circuits. Do not leave this board unattended when it is powered up.

Attention: The main board flyback output becomes unregulated if the CC plug-in board is disconnected.

ICC80QSG 84 W AC-DC reference design #1 with IPN70R450P7S

For power tool battery charger with 230 V AC rated input and CC output up to 4 A

Test setup and safety information



To test the board with the maximum CC set-point only, a test setup without the DC source can be done based on [Figure 3](#).

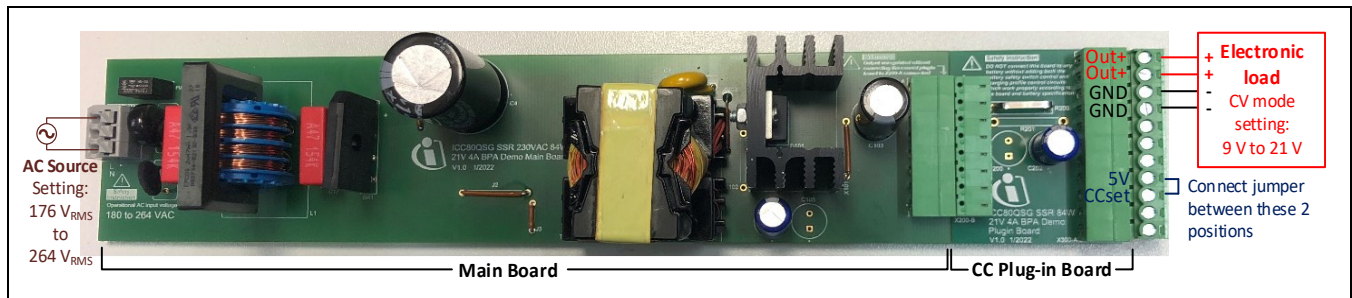

Figure 3 Test setup with electronic load and maximum CC set-point (4 A)

To test the board with the minimum CC set-point only, a test setup without the DC source can be done based on [Figure 4](#).

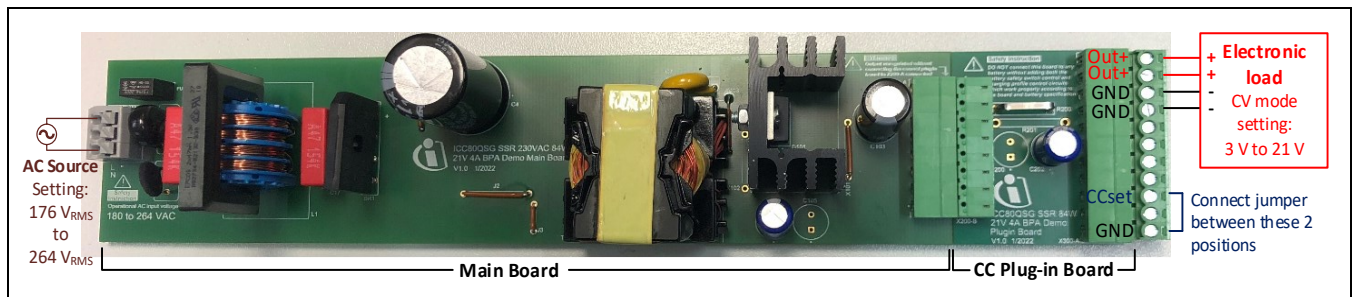

Figure 4 Test setup with electronic load and minimum CC set-point (0.4 A)

For EMI testing with full output power of 84 W, the test setup in [Figure 5](#) is recommended.

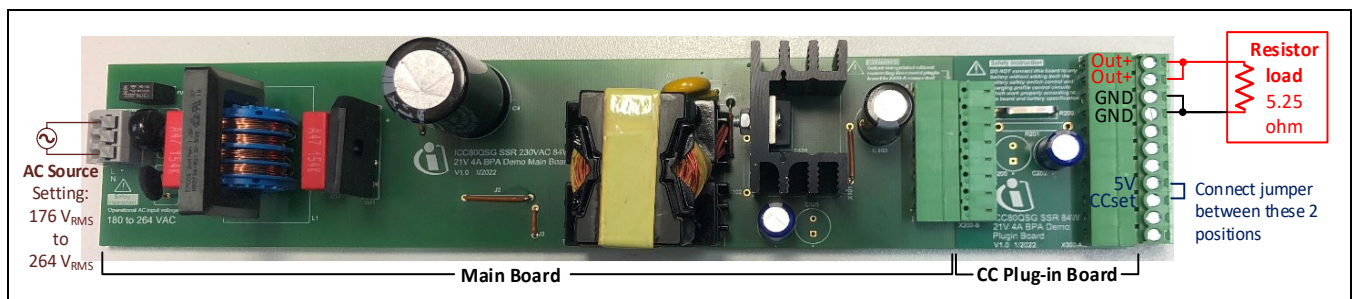

Figure 5 EMI test setup with full output power

For no-load system standby power measurement, the test setup in [Figure 6](#) is recommended.

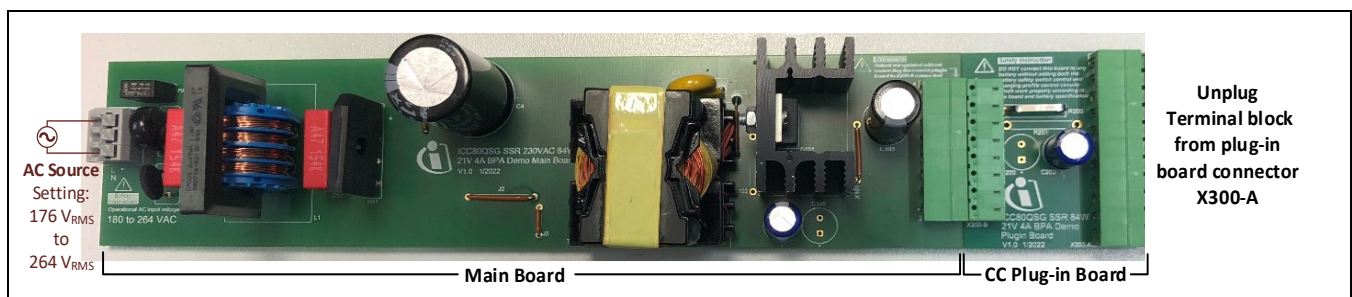

Figure 6 No-load system standby power test setup

2 Design features

- SSR, with adjustable CC output set-point from 0.4 to 4 A
- Supports wide output load range from 3 to 21 V (refer to the chapter “**Board specifications**” for details)
- High efficiency and low EMI with quasi-resonant (QR) valley switching
- Cost-effective flyback MOSFET with high performance, using **CoolMOS™ P7 in SOT-223 package**
- Full-power efficiency more than 90 percent at 230 V_{RMS} AC input
- Four-point average efficiency more than 90 percent at 21 V output load
- Burst mode with reduced gate driver output voltage for lower standby power
- System standby power less than 180 mW at 230 V_{RMS} AC input
- Supports IC disabling with external pull-down signal
- Configurable hysteresis of brown-in and brown-out
- Adaptive brown-out level triggering based on bus voltage ripple, to better protect primary components from overheating and saturation with higher brown-out level at higher power transfer
- Comprehensive set of protections: internal overtemperature protection (OTP), output overvoltage protection (OVP), V_{CC} OVP, primary side overcurrent protection (OCP), brown-in and brown-out protection
- Soft-start to reduce component stress during turn-on

3 Board specifications

Table 1 lists the electrical specifications of the evaluation board.

Table 1 Electrical specifications

Specification	Symbol	Value	Unit
Normal operational AC input voltage	V AC	176 to 264	V _{RMS}
Normal operational AC input frequency	F _{line}	47 to 63	Hz
CC output set-point	I _{out,setpoint}	0.4 to 4.0	A
CC output set-point control voltage (see Figure 7 for details)	CC _{set}	0 to 5	V
Output load range 1 (I _{out,setpoint} = 0.4 to 4.0 A)	V _{load,CV1}	9 to 21	V
Output load range 2 (I _{out,setpoint} = 0.4 A)	V _{load,CV2}	3 to 21	V
Input power under no-load condition (V AC = 230 V _{RMS} ; F _{line} = 50 Hz; output open)	P _{in,no-load}	Less than 180	mW
Steady-state output voltage limit under no-load condition	V _{out,FB,limit}	Around 24.6	V
Efficiency at full output power (V AC = 230 V _{RMS} ; output load = 21 V; I _{out,setpoint} = 4.0 A)	η	More than 90	%
Four-point average efficiency 1 (V AC = 176 V _{RMS} ; output load = 21 V; I _{out} = 1 A, 2 A, 3 A and 4 A)	η _{avg,4-point1}	More than 90	%
Four-point average efficiency 2 (V AC = 264 V _{RMS} ; output load = 21 V; I _{out} = 1 A, 2 A, 3 A and 4 A)	η _{avg,4-point2}	More than 90	%

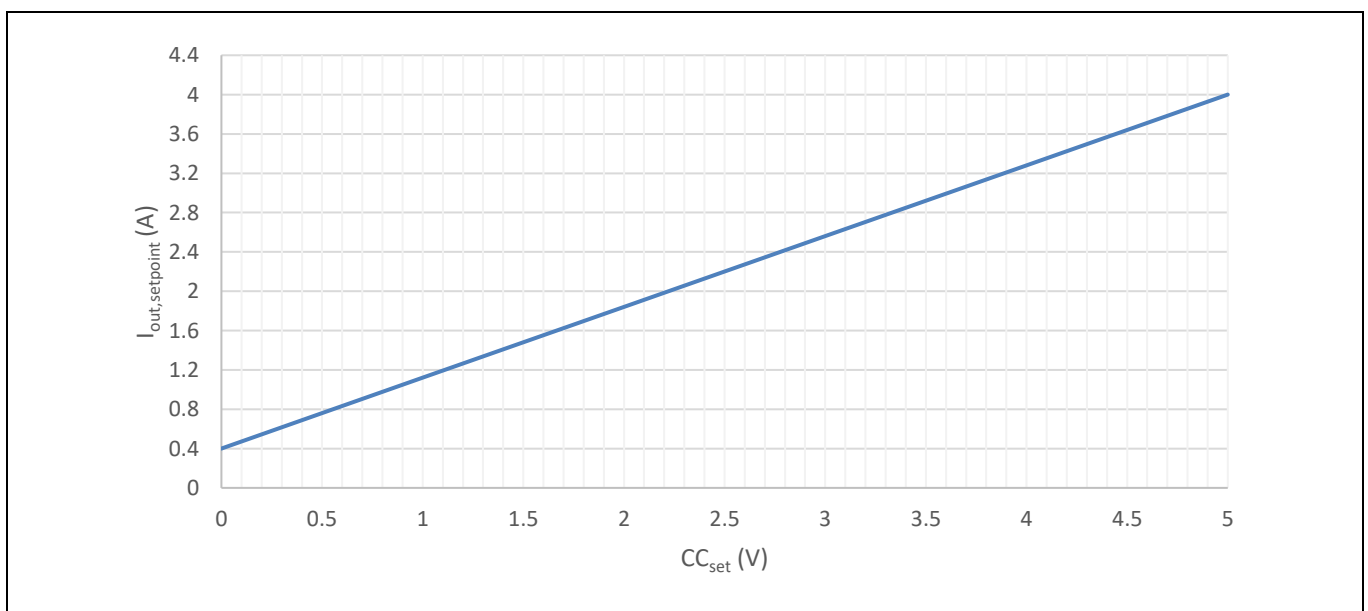

Figure 7 I_{out,setpoint} control based on CC_{set} input signal

ICC80QSG 84 W AC-DC reference design #1 with IPN70R450P7S
For power tool battery charger with 230 V AC rated input and CC output up to 4 A
Schematic and PCB layout

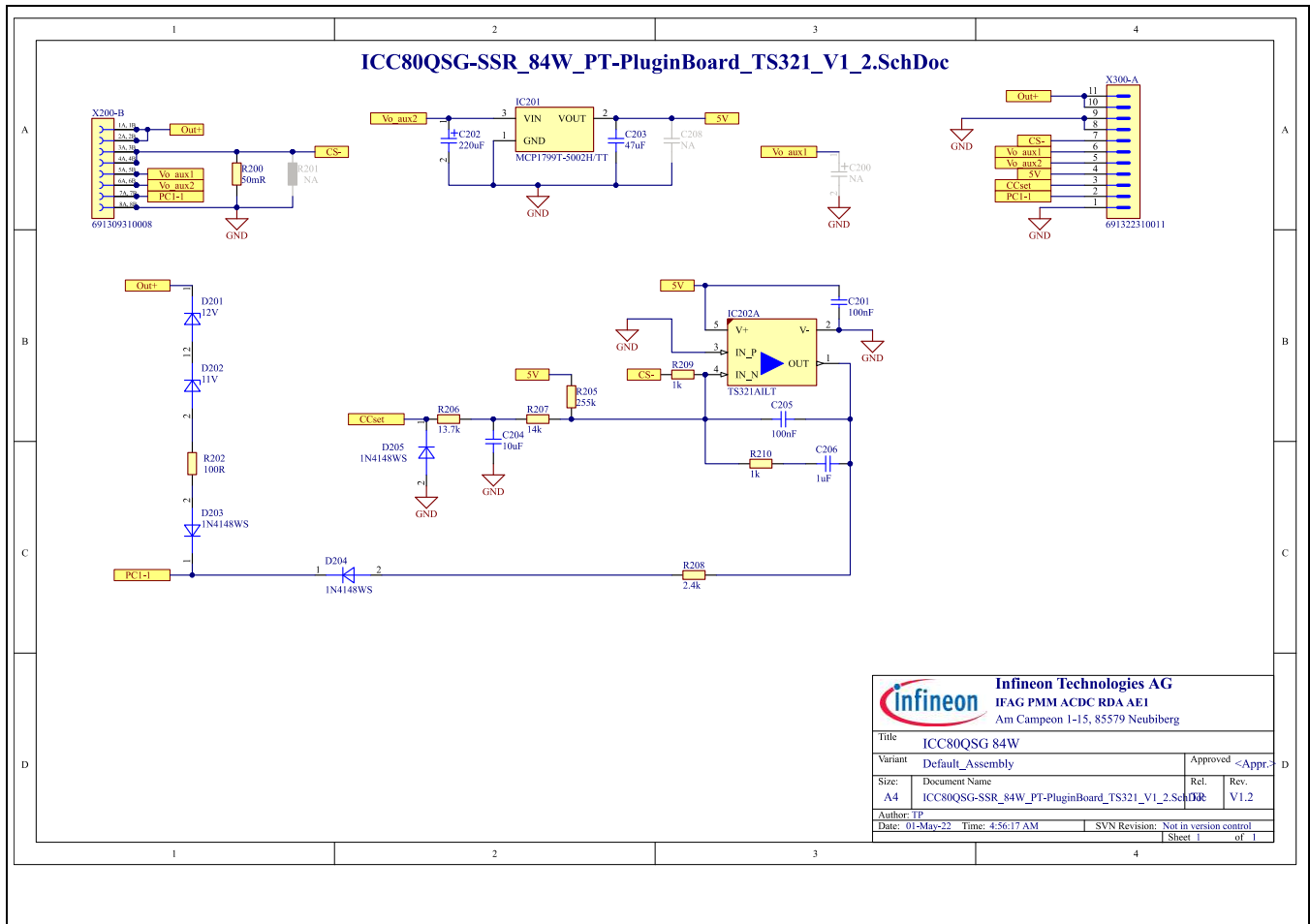

Figure 9 CC plug-in board schematic

Both the reference design main board and the CC plug-in board have a single-layer PCB layout design.

Figure 10 shows the PCB top layout (with dimensions) and bottom layout.

5 Performance

The results shown in this section are based on the evaluation of a single board, at room temperature.

5.1 Efficiency

The efficiency at full output power (84 W) is measured at more than 90 percent with typical V AC of 230 V_{RMS}, and more than 89 percent across the whole V AC range, as shown in [Figure 11](#).

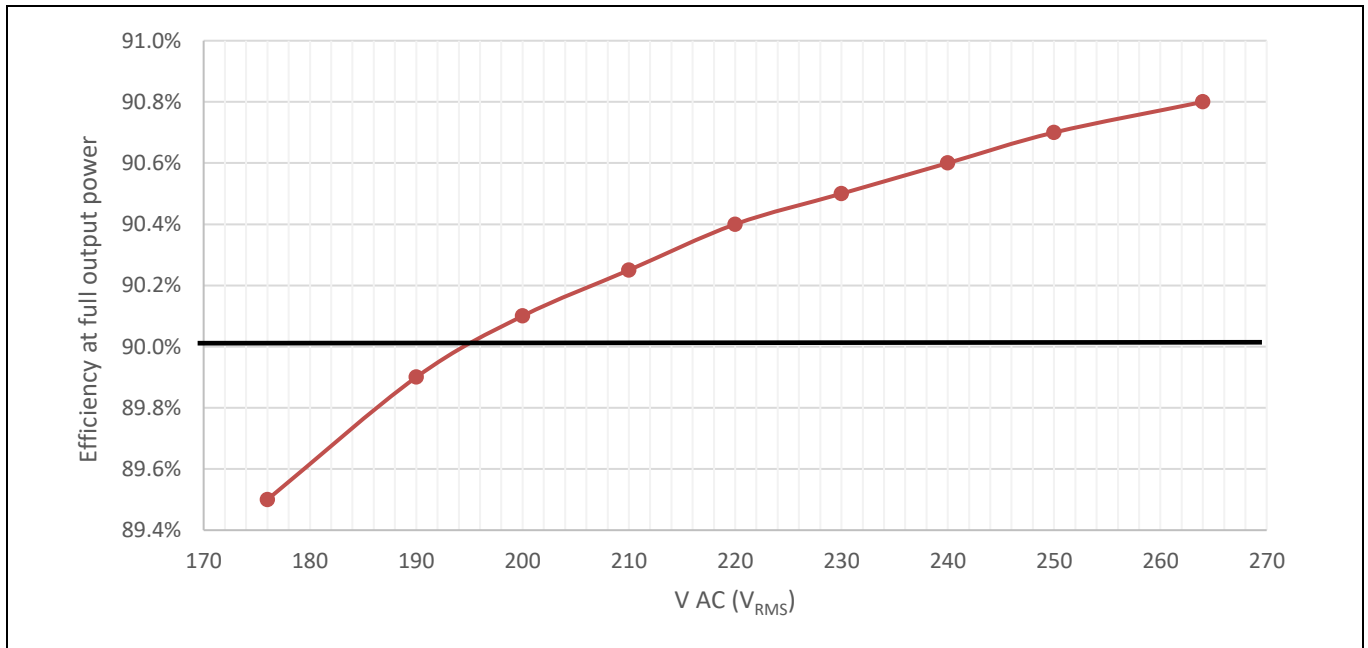

Figure 11 Efficiency at full output power (84 W)

The four-point average efficiency is measured at more than 90 percent with 21 V load, and in the range of 86 percent to 88 percent with 12 V load, as shown in [Table 2](#).

Table 2 Four-point average efficiency

V AC (V _{RMS})	Output load (V)	I _{out,setpoint} (mA)	Percent of I _{out,setpoint}	Efficiency	Four-point average efficiency
176	21	4000	100%	89.5%	90.6%
		3000	75%	90.7%	
		2000	50%	91.2%	
		1000	25%	91.1%	
264	21	4000	100%	90.8%	90.45%
		3000	75%	91.4%	
		2000	50%	91.0%	
		1000	25%	88.6%	
176	12	4000	100%	87.8%	88.4%
		3000	75%	88.9%	
		2000	50%	89.2%	
		1000	25%	87.7%	
264	12	4000	100%	88.4%	86.85%
		3000	75%	88.8%	
		2000	50%	87.8%	
		1000	25%	82.4%	

5.2 Standby power

Under no-load condition, the input power is measured as shown in [Figure 12](#).

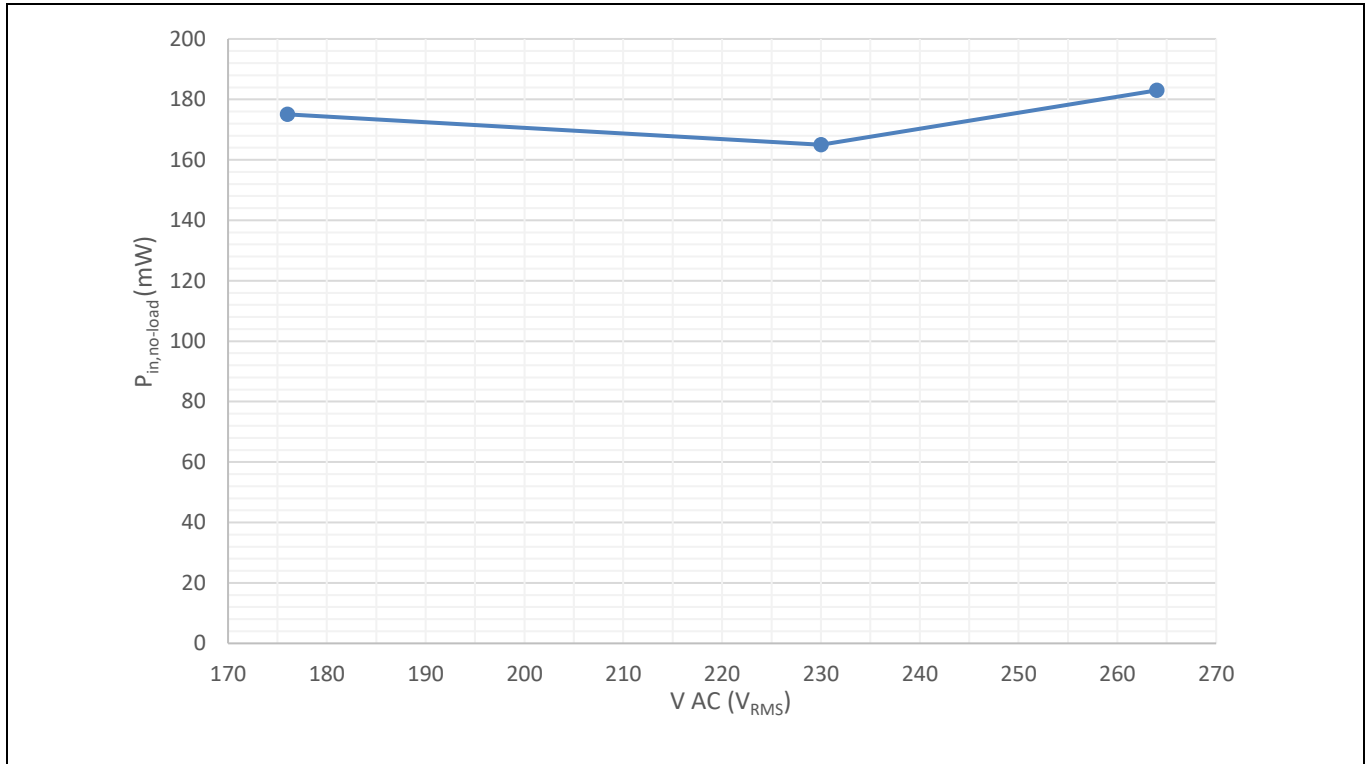

Figure 12 Input power under no-load condition

5.3 Brown-in and brown-out protection

ICC80QSG features not only the configurable hysteresis between brown-in and brown-out, but also adaptive brown-out level triggering based on bus voltage ripple.

As shown in [Table 3](#) and [Table 4](#), with these features, this reference design demonstrates a higher brown-out level at higher power transfer, while still ensuring sufficient hysteresis between brown-in and brown-out. As a result, ICC80QSG can better protect the primary components from overheating and saturation when input undervoltage condition occurs.

Table 3 Brown-in test result

F _{line} (Hz)	Output load (V)	I _{out,setpoint} (mA)	Percentage of I _{out,setpoint}	Brown-in V AC (V _{RMS})
50	21	0	0%	168
		4000	100%	

Table 4 Brown-out test result

F _{line} (Hz)	Output load (V)	I _{out,setpoint} (mA)	Percentage of I _{out,setpoint}	Brown-out V AC (V _{RMS})
50	21	0	0%	141.7
		4000	100%	154

5.4 Thermal test

The open-frame thermal measurement is done after one hour of operation with full output power (84 W), using an infrared thermography camera. The ambient temperature is approximately 20°C.

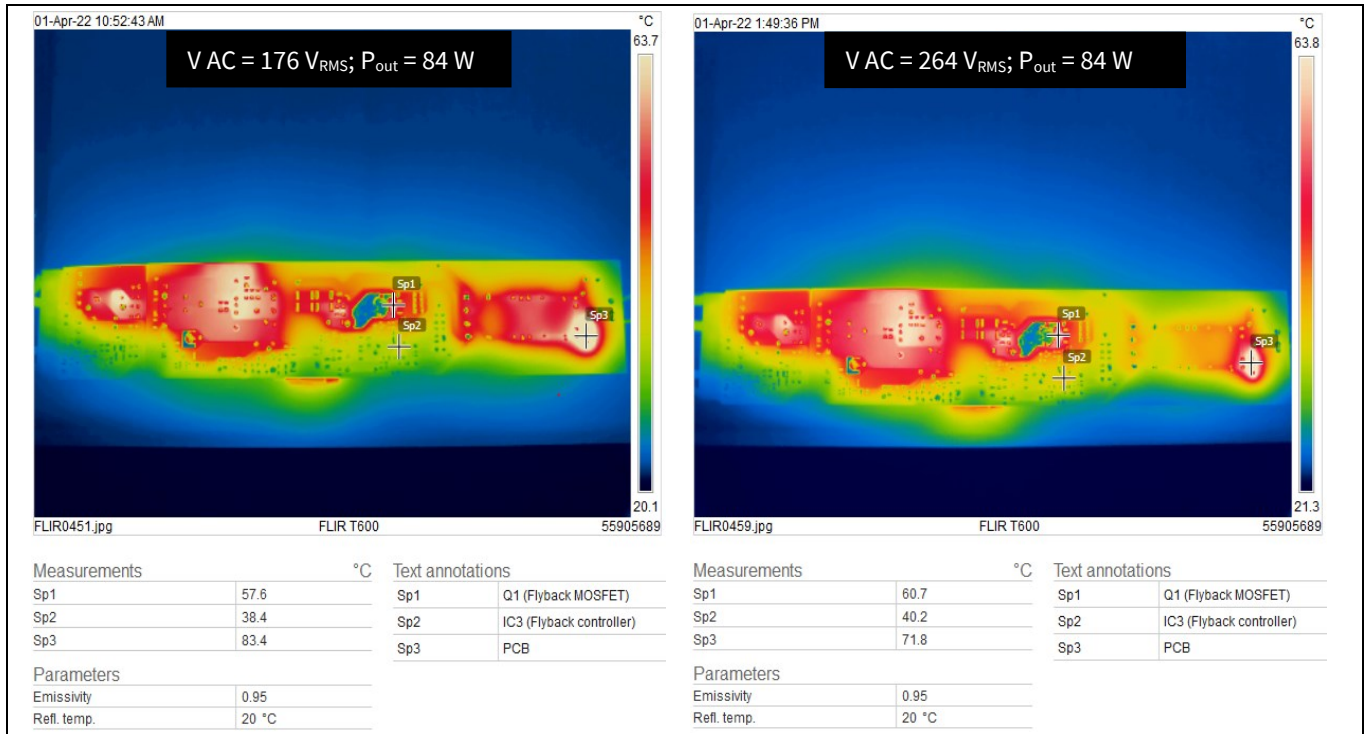

Figure 13 Infrared thermal image result of PCB bottom components

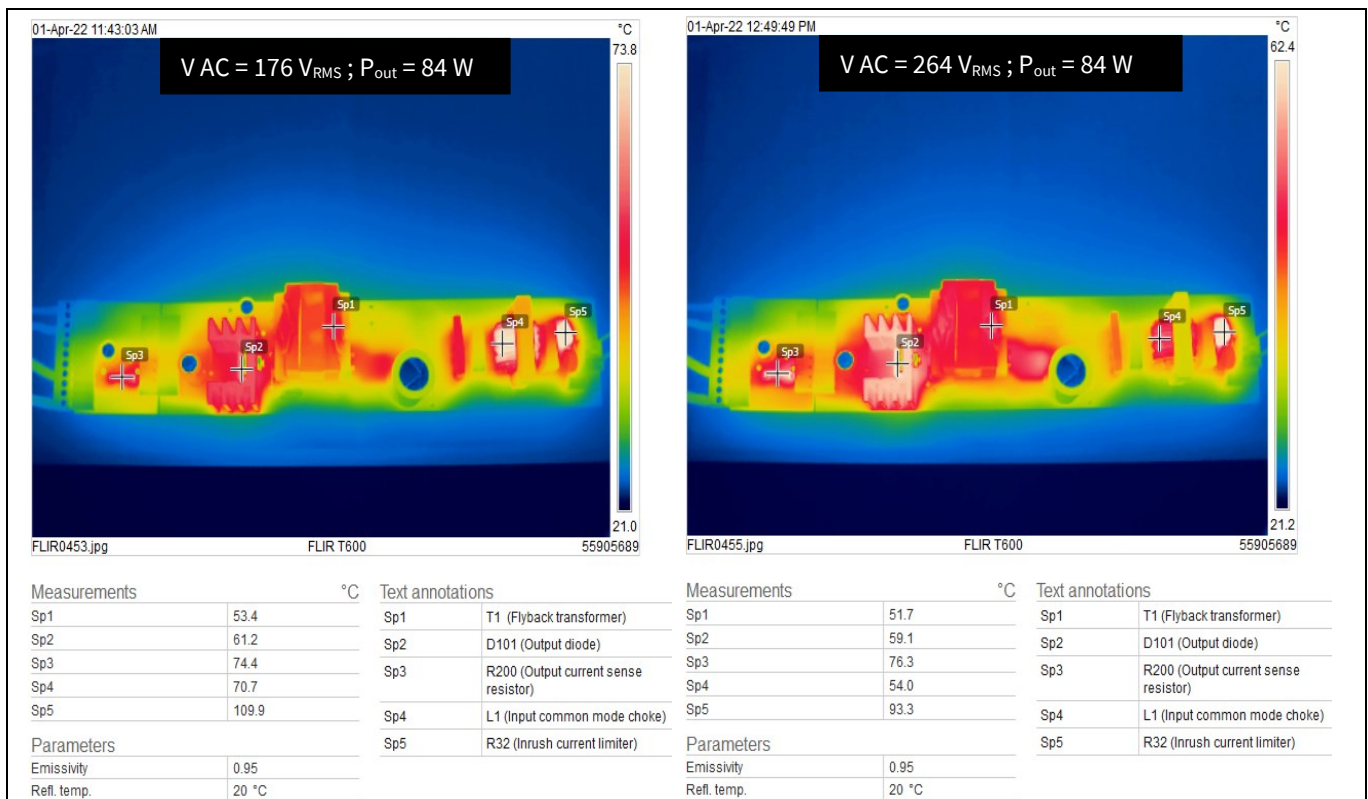

Figure 14 Infrared thermal image result of PCB top components

5.5 Conducted emissions (EN 55022 class B)

The conducted emissions test was performed at full output power (84 W), and there is more than a 6 dB margin observed for both live and neutral measurements based on EN 55022 standard class B limits.

The measurement equipment used for this conducted emissions test was Rohde & Schwarz HM6050-2 and Tektronix RSA503A.

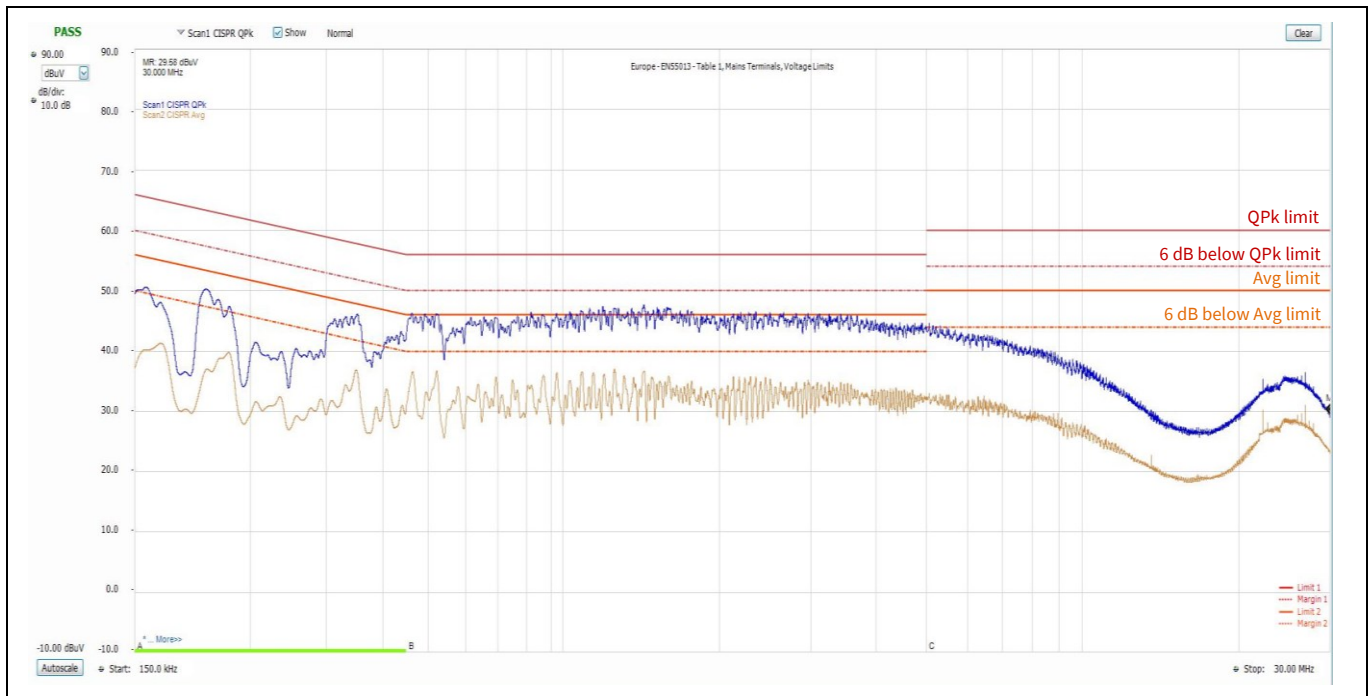

Figure 15 Conducted emissions (live) test result at $V_{AC} = 230 V_{RMS}$, $F_{line} = 50 \text{ Hz}$, and $P_{out} = 84 \text{ W}$

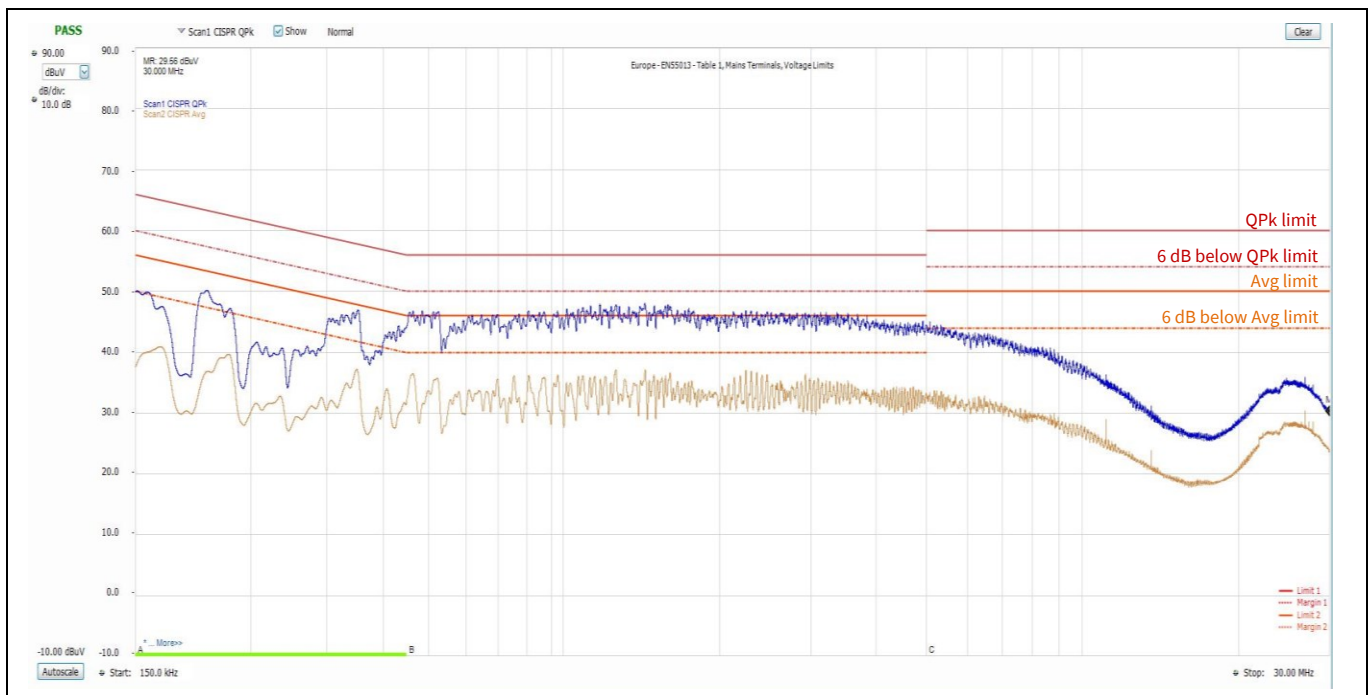

Figure 16 Conducted emissions (neutral) test result at $V_{AC} = 230 V_{RMS}$, $F_{line} = 50 \text{ Hz}$, and $P_{out} = 84 \text{ W}$

6 Bill of materials and transformer specifications

This section provides the bill of materials (BOM) and the transformer specifications.

6.1 BOM

Table 5 BOM of main board

Designator	Description	Part number	Manufacturer
BR1	Bridge rectifier 4 A/1000 V/ SIP345W114P508L2205H2125Q4B	GBU4M-BP	MCC
C1, C17	Capacitor 150 nF/310 V AC/radial/10%	890334025022CS	Würth Elektronik
C3	Capacitor 2.2 nF/630 V/1206/X7R/10%	CGA5H4X7R2J222K115AA	TDK
C4	Capacitor 120 µF/400 V/18 mm x 30 mm/20%	400BXW120MEFR18X30	Rubycon
C5	Capacitor 470 pF/50 V/0603/X8L/20%	CC0603KRX7R9BB471	Yageo
C6	10 µF/35 V/1206	GMK316AB7106KL-TR	Taiyo Yuden
C7	2200p/500 V AC/radial/500 V AC/disc/Y5U/20%	VY1222M47Y5UQ63V0	Vishay
C8	Capacitor 100 pF/1 kV/1206/C0G/5%	GRM31A5C3A101JW01	Murata
C12	Capacitor 2.2 µF/50 V/1206/X7R/10%	CGA5L3X7R1H225K160AB	TDK Corporation
C38	Capacitor 100 nF/50 V/0603/X7R/10%	06035C104K4Z2A	AVX
C41	Capacitor 100 nF/50 V/0603/X7R/10%	06035C104K4Z2A	AVX
C101	1 nF/630 V/CAPC3216X180N-4	CC1206JKNPOZBN102	Yageo
C103	680 µF/35 V/WCAP-ATG8_D10H20	EST687M035AH6AA	KEMET
C104	220 µF/35 V/CAPPRD350W60D825H1300B	ECA1VAM221X	Panasonic
C106	Capacitor 1 µF/100 V/1206/X7R/10%	12061C105KAT2A	AVX
C107, C112	Capacitor 100 nF/100 V/3216 (1206)/10%	CGA5H2X8R2A104K115AA	TDK Corporation
D3	Diode S2M/DO-214AA	S2M	ON Semiconductor
D4	Diode BAV103/SOD-80C	BAV103,115	Nexperia
D10	BAS416, 115/SOD-323	BAS416,115	Nexperia
D11	Diode 18 V/SOD-323 (SC-76)	BZX384-C18,115	Nexperia
D101	Diode MBR41H100CTG/TO-220	MBR41H100CTG	ON Semiconductor
D102	S215FA/150 V/SOD-123-FA	S215FA	ON Semiconductor
D104, D105	16 V/DIOM5226X264N	SMAZ16-13-F	DIODES
F1	Fuse 300 V/3.15 A/ FUSRR508W62L835T430H820B	SS-5H-3.15A-APH	Bussmann by Eaton
HS101	Heatsink SK 76 25 STS TO 220/THT	SK 76 25 STS TO 220	Fischer Elektronik
IC3	ICC80QSG/SOIC-8	ICC80QSG	Infineon
J1, J2	Connector JL-600-25-T/JP-THT-JL-600-25-T	JL-600-25-T (add sleeving), JL-600-25-T	Samtec
J3	Connector JL-250-25-T/JP-THT-JL-250-25-T	JL-250-25-T	Samtec
J5, R21	Resistor 0 R/150 V/0805	CRCW08050000Z0	Vishay
L1	47 mH/B82734R	B82734R2132B030	TDK Corporation
MOV2	Varistor, 510 V/510 V/radial type/10%	ERZE08A511	Panasonic
PC1	TLP383 (GR-TPL, E/TLP383)	TLP383(GR-TPL,E	Toshiba
Q1	IPN70R450P7S/PG-SOT-223-3	IPN70R450P7S	Infineon Technologies
Q10	Transformer BC847C, 215/45/SOT-23	BC847C,215	Nexperia

ICC80QSG 84 W AC-DC reference design #1 with IPN70R450P7S

For power tool battery charger with 230 V AC rated input and CC output up to 4 A

Bill of materials and transformer specifications



Designator	Description	Part number	Manufacturer
R1	Resistor 2.4 k/200 V/1206/1%	CRCW12062K40FK	Vishay
R2	Resistor 10 k/75 V/0603/1%	CRCW060310K0FK	Vishay
R3	Resistor 1.2 MEG/150 V/0805/1%	CRCW08051M20FK	Vishay
R4, R5	Resistor 4.99 MEG/200 V/1206/1%	CRCW12064M99FK	Vishay
R6	Resistor 510 k/200 V/1206/1%	CRCW1206510KFKEA	Vishay
R7, R8, R23, R24	Resistor 82 k/500 V/2512/1%	CRCW251282K0FK	Vishay
R9, R14, R39	Resistor 1 R/200 V/1206/1%	CRCW12061R00FK	Vishay
R10	Resistor 62 k/150 V/0805/1%	CRCW080562K0FK	Vishay
R11	Resistor 12 k/75 V/0603/1%	CRCW060312K0FK	Vishay
R15, R15a	Resistor 75 R/200 V/1206/1%	CRCW120675R0FK	Vishay
R16	Resistor 47 R/200 V/1206/1%	CRCW120647R0FK	Vishay
R17	Resistor 30 k/75 V/0603/1%	CRCW060330K0FK	Vishay
R19, R29, R30	Resistor 1.6 MEG/200 V/1206/1%	CRCW12061M60FK	Vishay
R22	Resistor 10 R/75 V/0603/1%	CRCW060310R0FK	Vishay
R25	Resistor 68 k/75 V/0603/1%	CRCW060368K0FKEA	Vishay
R28	Resistor 56 k/75 V/0603/1%	CRCW060356K0FK	Vishay
R32	8 R/VARRR525W60L950T600H1400B	B57235S809M54	TDK Corporation
R33, R34	Resistor 620 k/200 V/1206/1%	CRCW1206620KFK	Vishay
R40, R41	Resistor 1.5 R/200 V/1206/1%	CRCW12061R50FK	Vishay
R101, R110, R111	Resistor 47 R/200 V/1206/1%	CRCW120647R0FKEAHP	Vishay
R102	Resistor 0 R/200 V/1206/0%	CRCW12060000Z0EA	Vishay
R112	Resistor 100 R/200 V/1206/5%	AC1206JR-07100RL	Yageo
T1	750845331 Rev 02/PQ3220	750845331 Rev02	Würth Elektronik
X1	250-203/WAGO_250-203	250-203	WAGO
X103	Connector JL-500-25-T/ JP-THT-JL-500-25-T	JL-500-25-T	Samtec
X200-A	Connector 691322310008/WR-TBL	691322310008	Würth Elektronik

Table 6 BOM of CC plug-in board

Designator	Description	Part number	Manufacturer
C201, C205	100 nF/50 V/0805/X7R/10%	GRM21BR71H104KA01	Murata
C202	220 µF/35 V/CAPPRD350W60D825H1300B	ECA1VAM221X	Panasonic
C203	47 µF/16 V/CAPC3225X270N	GRM32EC81C476KE15K	Murata
C204	10 µF/16 V/CAPC3216X180N	GCM31CR71C106KA64L	Murata
C206	1 µF/50 V/0805/X7R/10%	GCM21BR71H105KA03	Murata
D201	Diode 12 V/SOD-123	MMSZ4699T1G	ON Semiconductor
D202	11 V/SOD-3715X135N-1	MMSZ11T1G	ON Semiconductor
D203, D204, D205	Diode 1N4148WS/SOD-323	1N4148WS-7-F	Diodes Incorporated
IC201	Power MCP1799T-5002H/TT/SOT-23	MCP1799T-5002H/TT	Microchip Technology
IC202	TS321AILT/SOT-23-5	TS321AILT	ST

ICC80QSG 84 W AC-DC reference design #1 with IPN70R450P7S

For power tool battery charger with 230 V AC rated input and CC output up to 4 A

Bill of materials and transformer specifications



Designator	Description	Part number	Manufacturer
R200	Resistor 50 mR/length: 11.43 mm width: 1.65 mm height: 5.08 mm/1%	OAR1R050FLF	TT Electronics
R202	Resistor 100 R/200 V/1206/5%	AC1206JR-07100RL	Yageo
R205	Resistor 255 k/150 V/0805/1%	CRCW0805255KFK	Vishay
R206	Resistor 13.7 k/150 V/0805/1%	CRCW080513K7FK	Vishay
R207	Resistor 14 k/150 V/0805/1%	CRCW080514K0FK	Vishay
R208	Resistor 2.4 k/150 V/0805/1%	CRCW08052K40FK	Vishay
R209, R210	Resistor 1 k/150 V/0805/1%	CRM0805-FW-1001 E LF	Bourns
X200-B	Connector 691309310008/WR-TBL	691309310008	Würth Elektronik
X300-A	Connector 691322310011/43.1 mm x 9.2 mm	691322310011 and 691361300011	Würth Elektronik

6.2 Transformer specifications

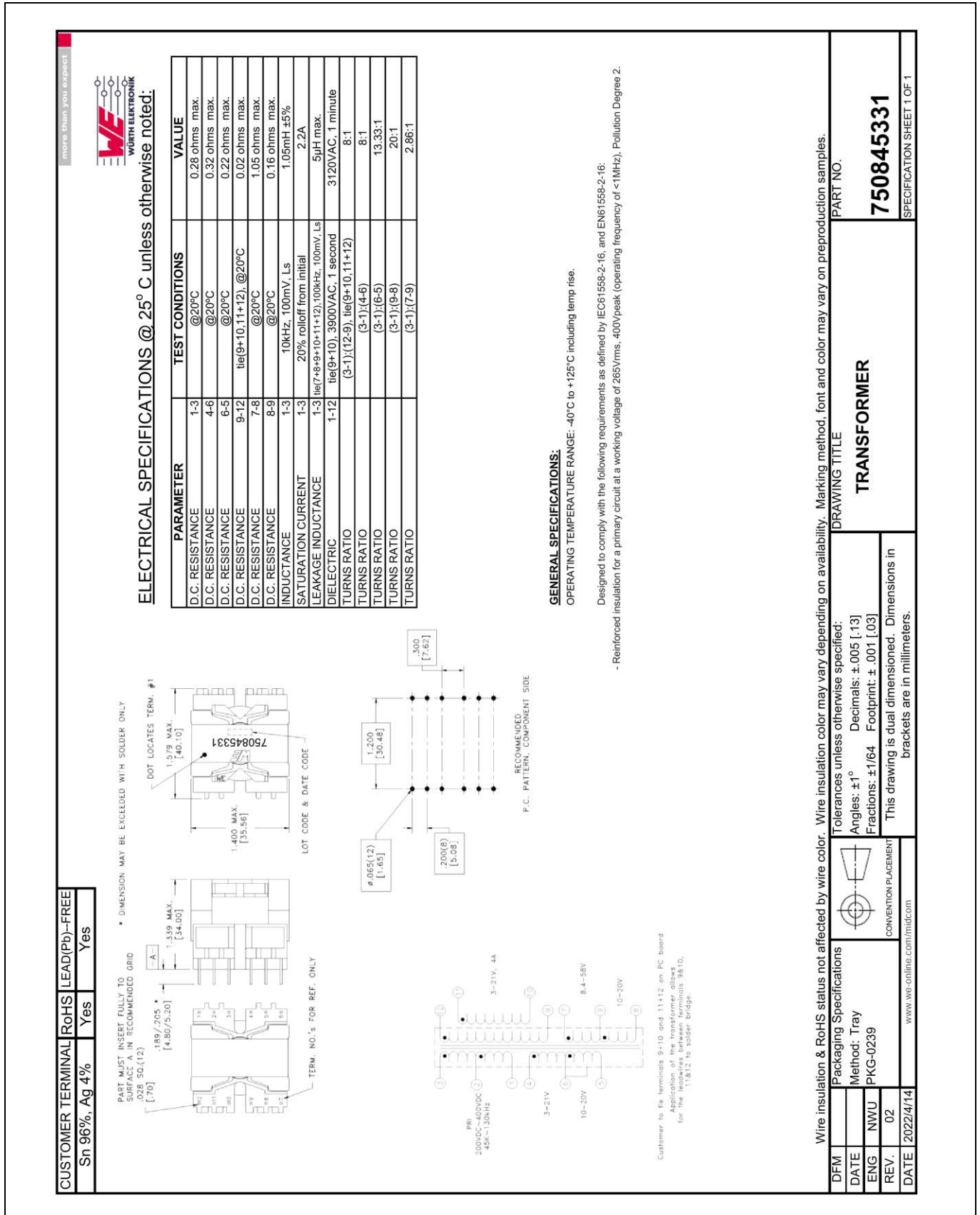

Figure 17 Flyback transformer (T1) specifications



Revision history

Document version	Date of release	Description of changes
V 1.0	2022-05-05	Initial release

Trademarks

All referenced product or service names and trademarks are the property of their respective owners.

Edition 2022-05-05

Published by

Infineon Technologies AG

81726 Munich, Germany

© 2022 Infineon Technologies AG.

All Rights Reserved.

Do you have a question about this document?

Email: erratum@infineon.com

Document reference

ER_2203_PL21_2204_231108

IMPORTANT NOTICE

The information contained in this application note is given as a hint for the implementation of the product only and shall in no event be regarded as a description or warranty of a certain functionality, condition or quality of the product. Before implementation of the product, the recipient of this application note must verify any function and other technical information given herein in the real application. Infineon Technologies hereby disclaims any and all warranties and liabilities of any kind (including without limitation warranties of non-infringement of intellectual property rights of any third party) with respect to any and all information given in this application note.

The data contained in this document is exclusively intended for technically trained staff. It is the responsibility of customer's technical departments to evaluate the suitability of the product for the intended application and the completeness of the product information given in this document with respect to such application.

For further information on the product, technology, delivery terms and conditions and prices please contact your nearest Infineon Technologies office (www.infineon.com).

WARNINGS

Due to technical requirements products may contain dangerous substances. For information on the types in question please contact your nearest Infineon Technologies office.

Except as otherwise explicitly approved by Infineon Technologies in a written document signed by authorized representatives of Infineon Technologies, Infineon Technologies' products may not be used in any applications where a failure of the product or any consequences of the use thereof can reasonably be expected to result in personal injury.