

LE UW U1A3 01

OSRAM OSTAR® Headlamp Pro

OSRAM OSTAR Headlamp is designed for applications where high brightness is required. Due to a seamless white colour impression at a maximum brightness level and its scalable brightness.

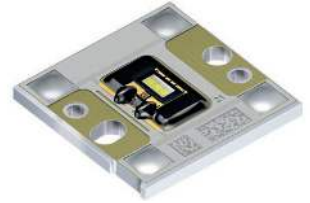

Applications

- Headlamps, LED & Laser & Night Vision

Features:

- Package: compact lightsource in multi chip on board technology
- Chip technology: UX:3
- Typ. Radiation: 120° (Lambertian emitter)
- Color: Cx = 0.322, Cy = 0.334 acc. to CIE 1931 (● ultra white)
- Corrosion Robustness Class: 3B
- Qualifications: The product qualification test plan is based on the guidelines of AEC-Q101-REV-C, Stress Test Qualification for Automotive Grade Discrete Semiconductors.
- ESD: 8 kV acc. to ANSI/ESDA/JEDEC JS-001 (HBM, Class 3B)

Ordering Information

Type	Luminous Flux ¹⁾ I _F = 1000 mA Φ _v	Ordering Code
LE UW U1A3 01-6Q6R-ebvF68ebzB68	800 ... 1400 lm	Q65111A7563

Maximum Ratings

Parameter	Symbol		Values
Operating Temperature	T_{op}	min.	-40 °C
		max.	135 °C
Storage Temperature	T_{stg}	min.	-40 °C
		max.	135 °C
Junction Temperature	T_j	max.	150 °C
Junction temperature for short time applications*	T_j	max.	175 °C
Forward Current $T_B = 25\text{ °C}$	I_F	min.	50 mA
		max.	1500 mA
Forward Current pulsed (acc. pulse derating on page 10)	$I_{F\ pulse}$		2000 mA
ESD withstand voltage acc. to ANSI/ESDA/JEDEC JS-001 (HBM, Class 3B)	V_{ESD}		8 kV
Reverse current ²⁾	I_R	max.	200 mA

*The LED chip exhibits excellent performance but slight package discoloration occurs at highest temperatures. Exemplary median lifetime for $T_j = 175\text{ °C}$ is 100h.

Characteristics

$I_F = 1000 \text{ mA}$; $T_B = 25 \text{ °C}$

Parameter	Symbol		Values
Chromaticity Coordinate ³⁾	C_x	typ.	0.322
	C_y	typ.	0.334
Viewing angle at 50% I_V	2ϕ	typ.	120 °
Radiating surface	A_{color}	typ.	3.3 mm ²
Forward Voltage ⁴⁾ $I_F = 1000 \text{ mA}$	V_F	min.	8.90 V
		typ.	9.35 V
		max.	10.70 V
Reverse voltage (ESD device)	$V_{R\text{ESD}}$	min.	45 V
Reverse voltage ²⁾ $I_R = 20 \text{ mA}$	V_R	max.	1.2 V
Real thermal resistance junction/board ⁵⁾	$R_{\text{thJB real}}$	typ.	2.0 K / W
		max.	2.4 K / W
Electrical thermal resistance junction/board ⁵⁾ with efficiency $\eta_e = 30 \%$	$R_{\text{thJB elec.}}$	typ.	1.4 K / W
		max.	1.7 K / W

Brightness Groups

Group	Luminous Flux ¹⁾ $I_F = 1000 \text{ mA}$ min. Φ_V	Luminous Flux ¹⁾ $I_F = 1000 \text{ mA}$ max. Φ_V	Luminous Intensity ⁶⁾ $I_F = 1000 \text{ mA}$ typ. I_v
6Q	800 lm	900 lm	280 cd
7Q	900 lm	1000 lm	320 cd
8Q	1000 lm	1120 lm	350 cd
5R	1120 lm	1250 lm	390 cd
6R	1250 lm	1400 lm	440 cd

Chromaticity Coordinate Groups ³⁾

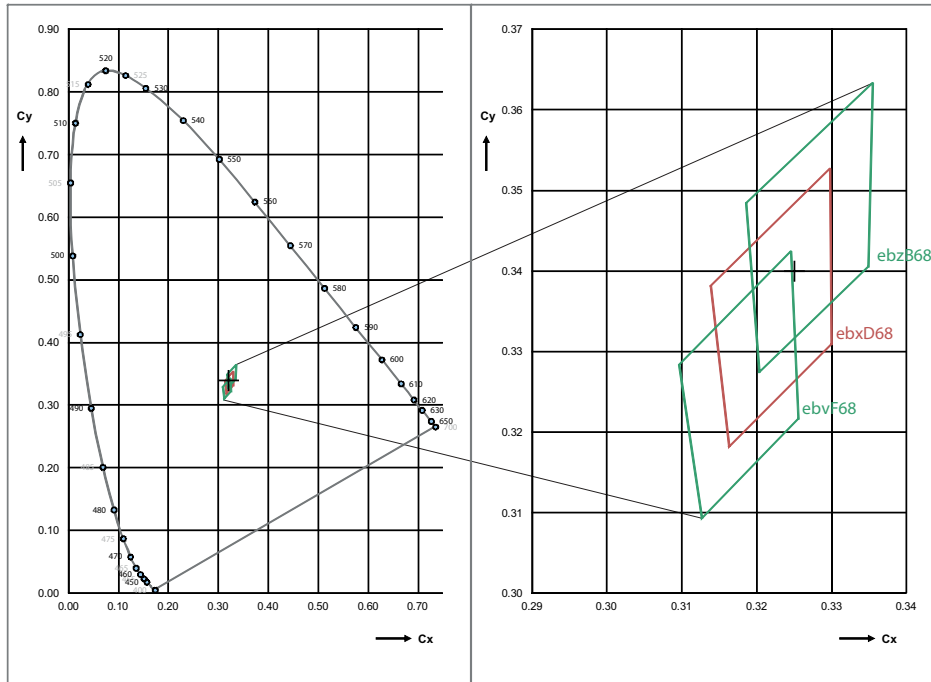

Chromaticity Coordinate Groups ³⁾

Group	Cx	Cy	Group	Cx	Cy	Group	Cx	Cy
ebvF68	0.3246	0.3424	ebxD68	0.3298	0.3526	ebzB68	0.3355	0.3633
	0.3255	0.3216		0.3300	0.3308		0.3349	0.3404
	0.3127	0.3093		0.3163	0.3181		0.3203	0.3274
	0.3096	0.3282		0.3138	0.3381		0.3186	0.3484

Not for new design

Group Name on Label

Example: 5R-ebvF68

Brightness

Color Chromaticity

5R

ebvF68

Relative Spectral Emission ⁶⁾

$\Phi_{rel} = f(\lambda); I_F = 1000 \text{ mA}; T_B = 25 \text{ }^\circ\text{C}$

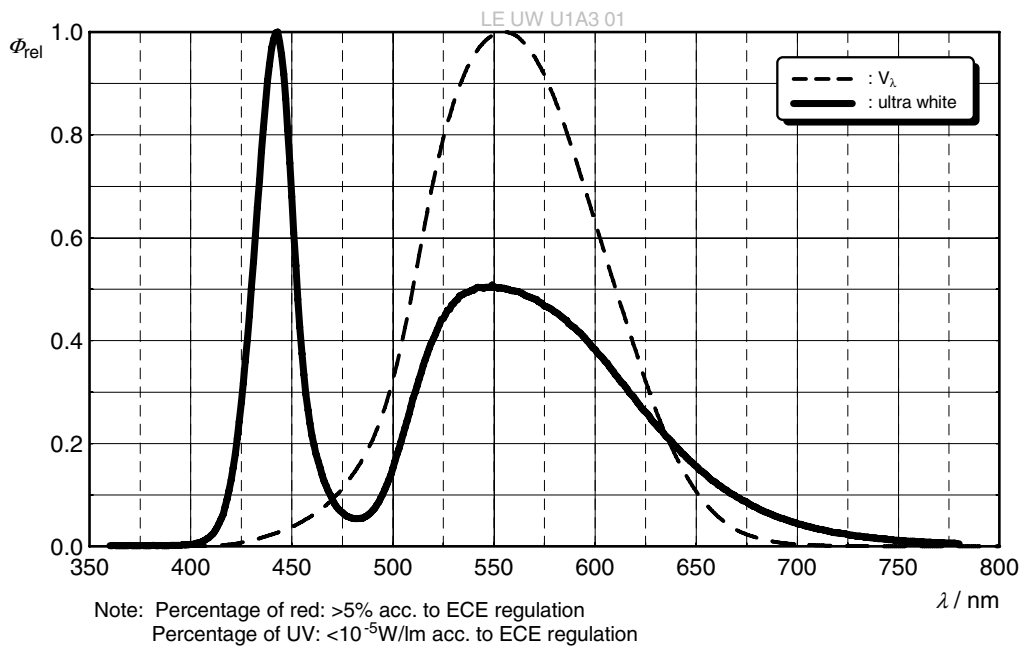

Radiation Characteristics ⁶⁾

$I_{rel} = f(\phi); T_B = 25 \text{ }^\circ\text{C}$

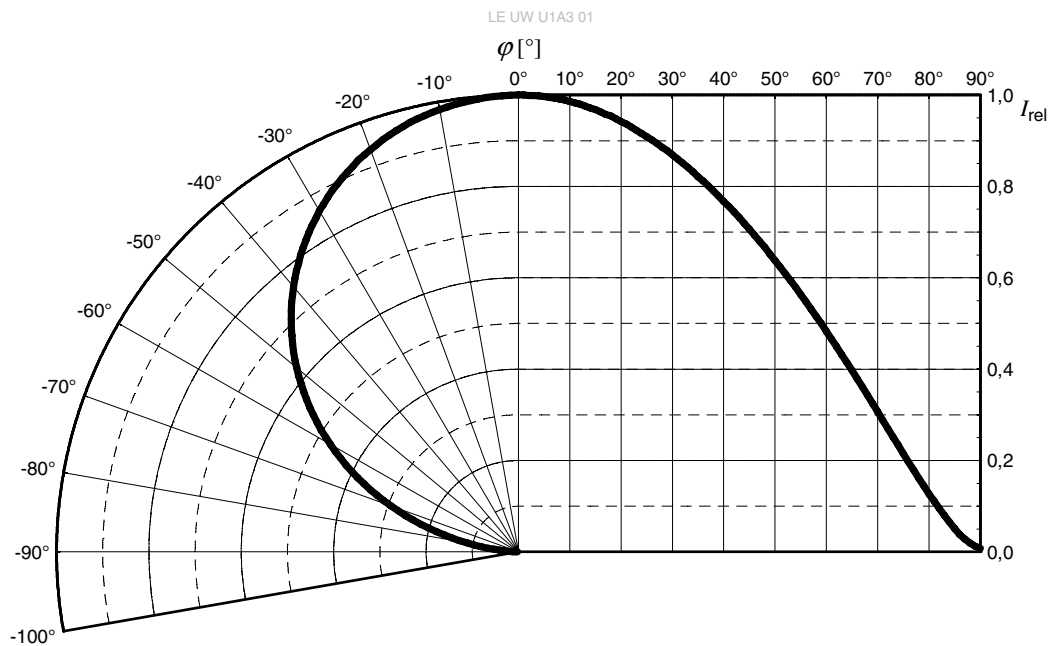

Not for new design

Forward current 6), 7)

$I_F = f(V_F); T_B = 25\text{ °C}$

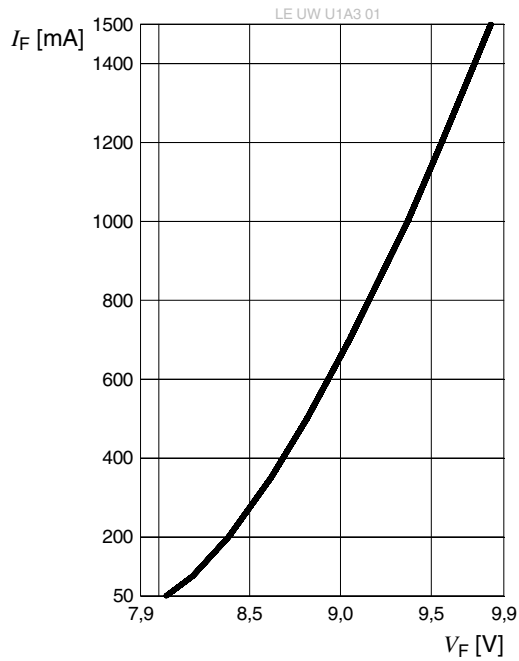

Relative Luminous Flux 6), 7)

$\Phi_V / \Phi_V(1000\text{ mA}) = f(I_F); T_B = 25\text{ °C}$

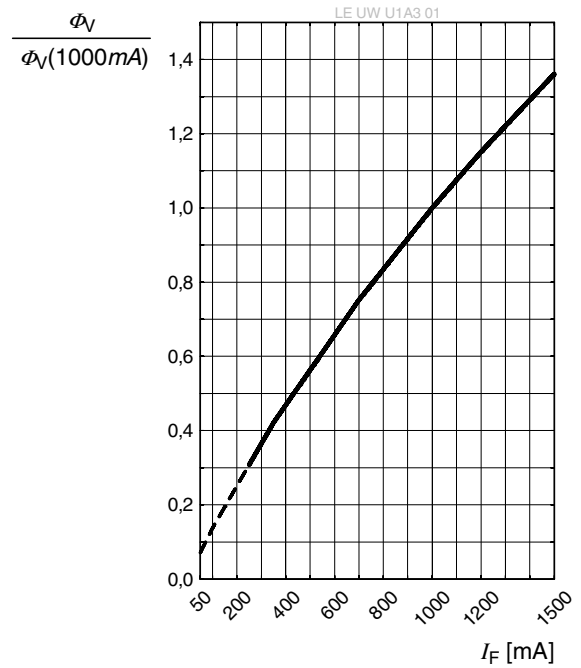

Chromaticity Coordinate Shift 6)

$C_x, C_y = f(I_F); T_B = 25\text{ °C}$

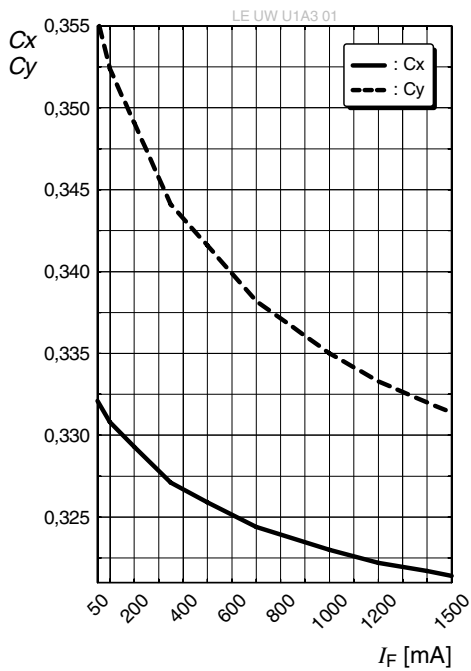

Not for new design

Forward Voltage ⁶⁾

$$\Delta V_F = V_F - V_F(25\text{ °C}) = f(T_j); I_F = 1000\text{ mA}$$

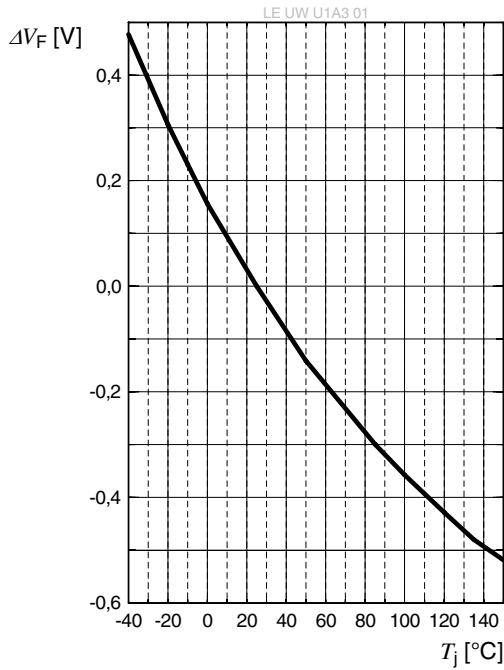

Relative Luminous Flux ⁶⁾

$$\Phi_V / \Phi_V(25\text{ °C}) = f(T_j); I_F = 1000\text{ mA}$$

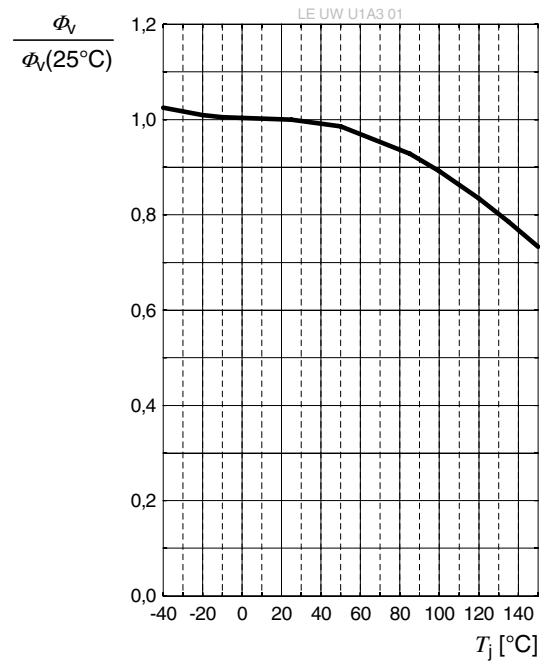

Chromaticity Coordinate Shift ⁶⁾

$$C_x, C_y = f(T_j); I_F = 1000\text{ mA}$$

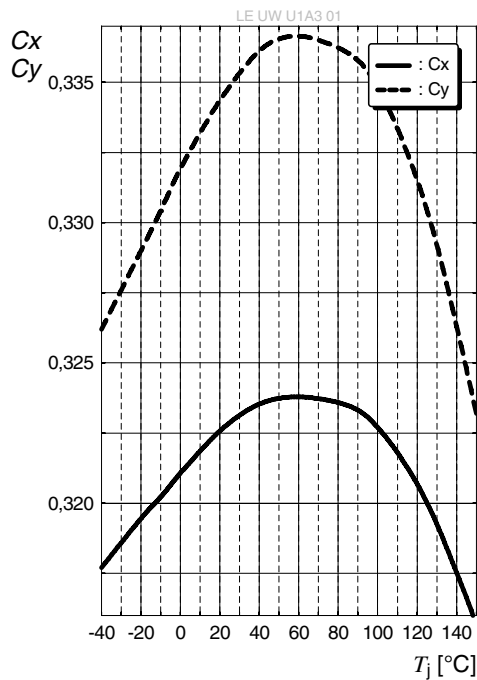

Not for new design

Max. Permissible Forward Current

$I_F = f(T); 0.7 \cdot \Phi_{V \text{ min.}}$ of bin 6Q; $R_{th \text{ real max.}}$

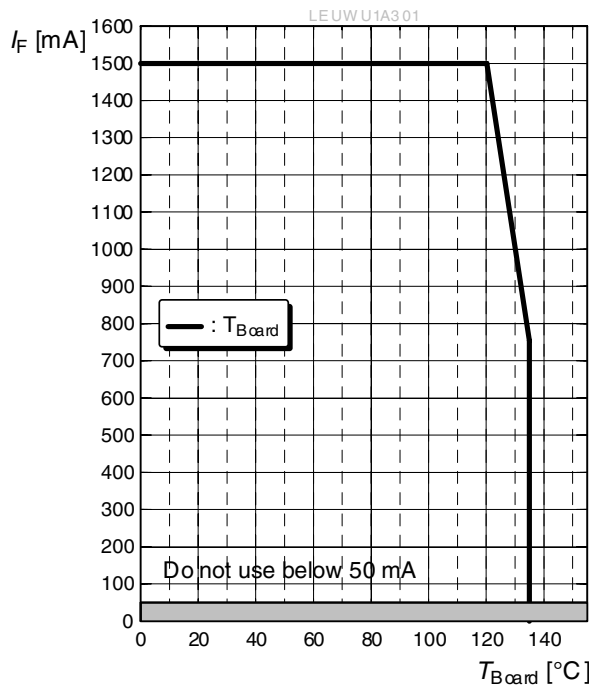

Permissible Pulse Handling Capability

$I_F = f(t_p); D$: Duty cycle

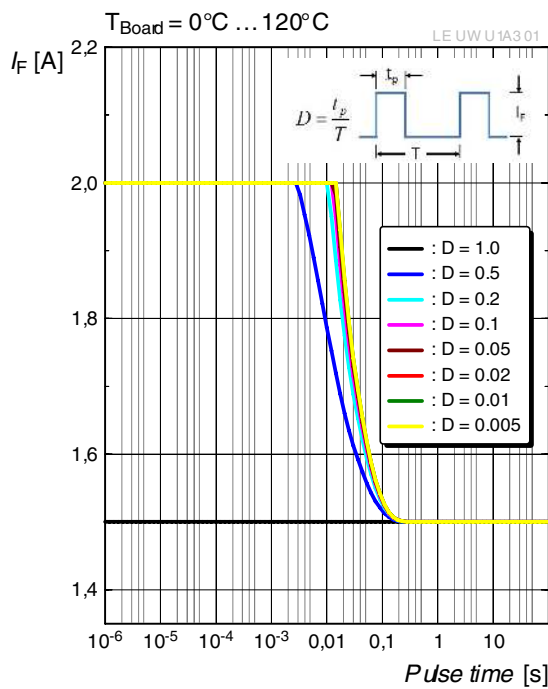

Permissible Pulse Handling Capability

$I_F = f(t_p); D$: Duty cycle

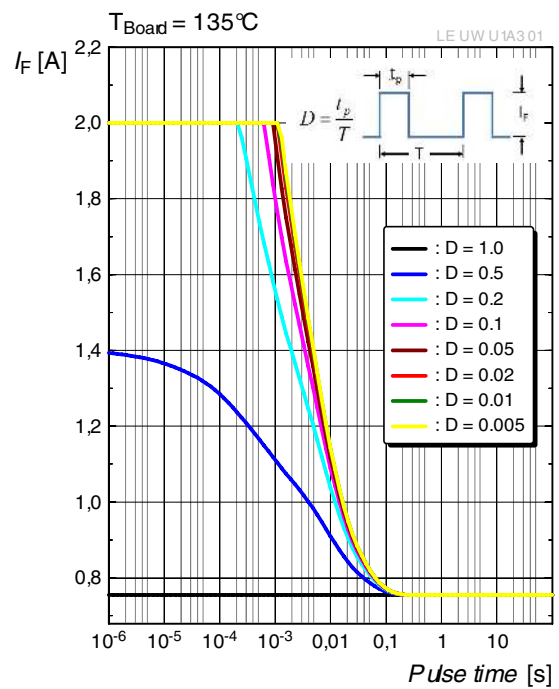

Not for new design

Dimensional Drawing ⁸⁾

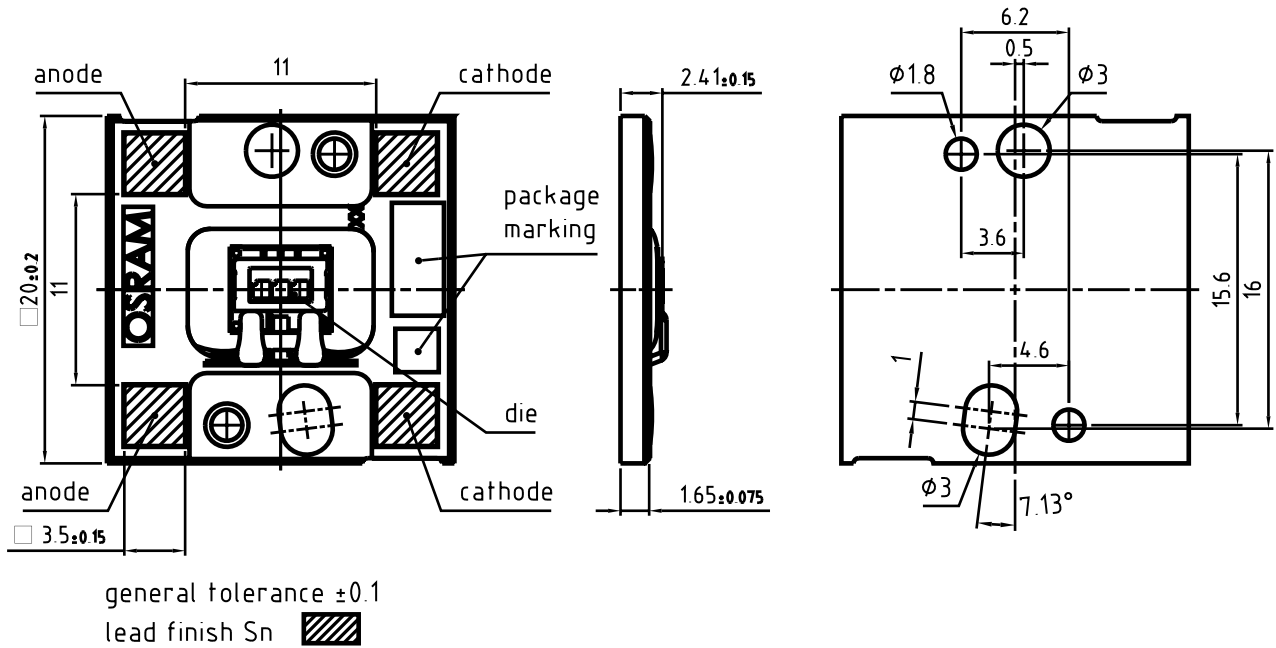

C63062-A4212-A1-03

Further Information:

Approximate Weight: 1,800.0 mg

Corrosion test: Class: 3B
 Test condition: 40°C / 90 % RH / 15 ppm H₂S / 14 days (stricter than IEC 60068-2-43)

ESD advice: The device is protected by ESD device which is connected in parallel to the Chip.

Notes: Package not suitable for any kind of wet cleaning or ultrasonic cleaning.

Electrical Internal Circuit

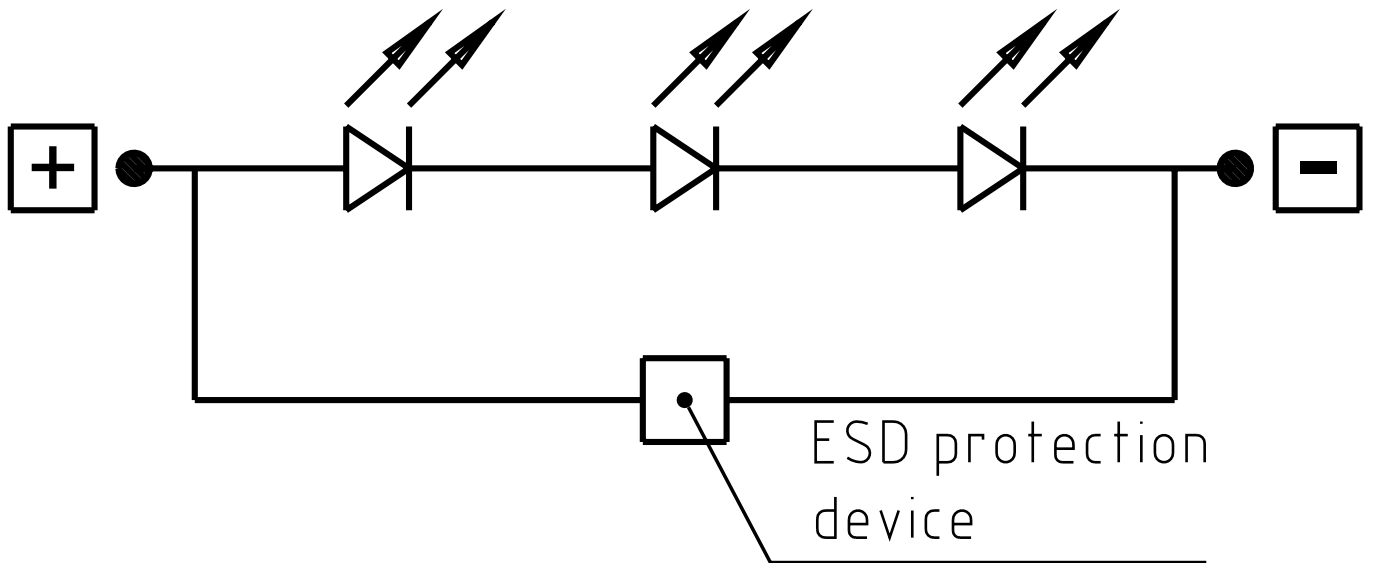

Tray 8)

60 pieces per Tray

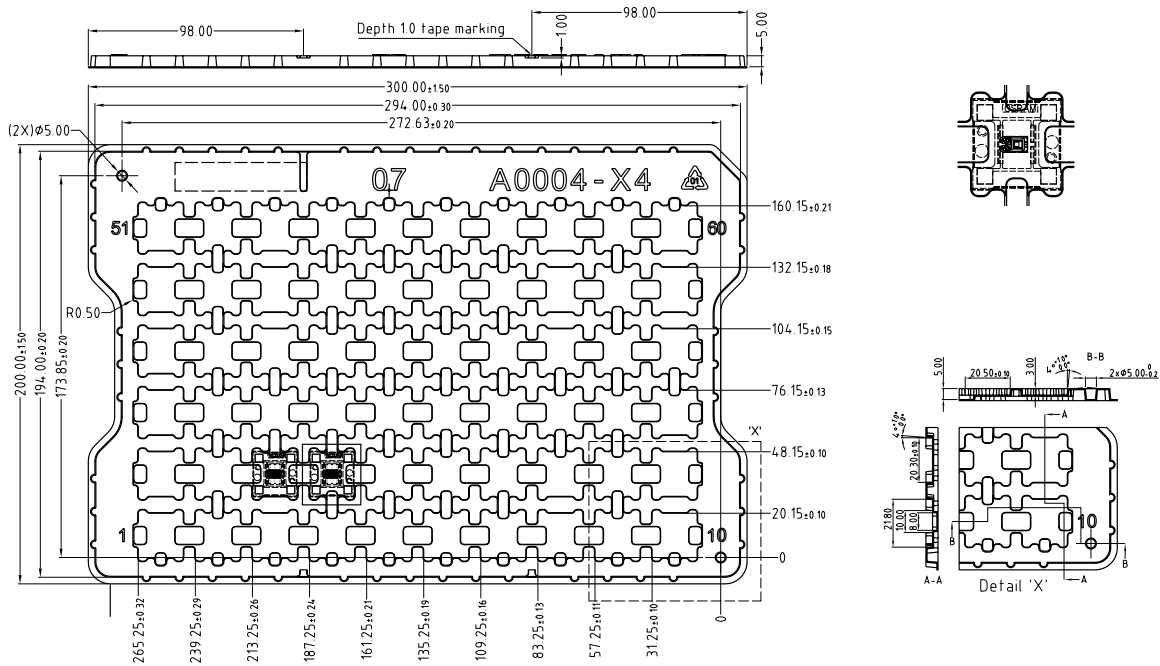

C67062-A0004-X4-03

Not for new design

Barcode-Product-Label (BPL)

OSRAM Opto Semiconductors LX XXXX BIN1: XX-XX-X-XXX-X

RoHS Compliant





(6P) BATCH NO: 1234567890

(1T) LOT NO: 1234567890 (9D) D/C: 1234

(X) PROD NO: 123456789(Q)QTY: 9999 (G) GROUP: XX-XX-X-X

ML Temp ST
X XXX °C X

Pack: RXX
DEMY XXX
X_X123_1234.1234 X

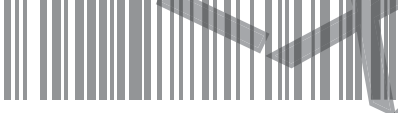

OHA04563



Barcode-Tray-Label (BTL)

LE xxx xxx Group: xxxx-xxxx-xxxx

Data Matrix Code

xxxx BIN

MATERIAL: Material Number Batch Batch Number BIN: xxxx



OHA02684_1

Schematic Transportation Box ⁸⁾

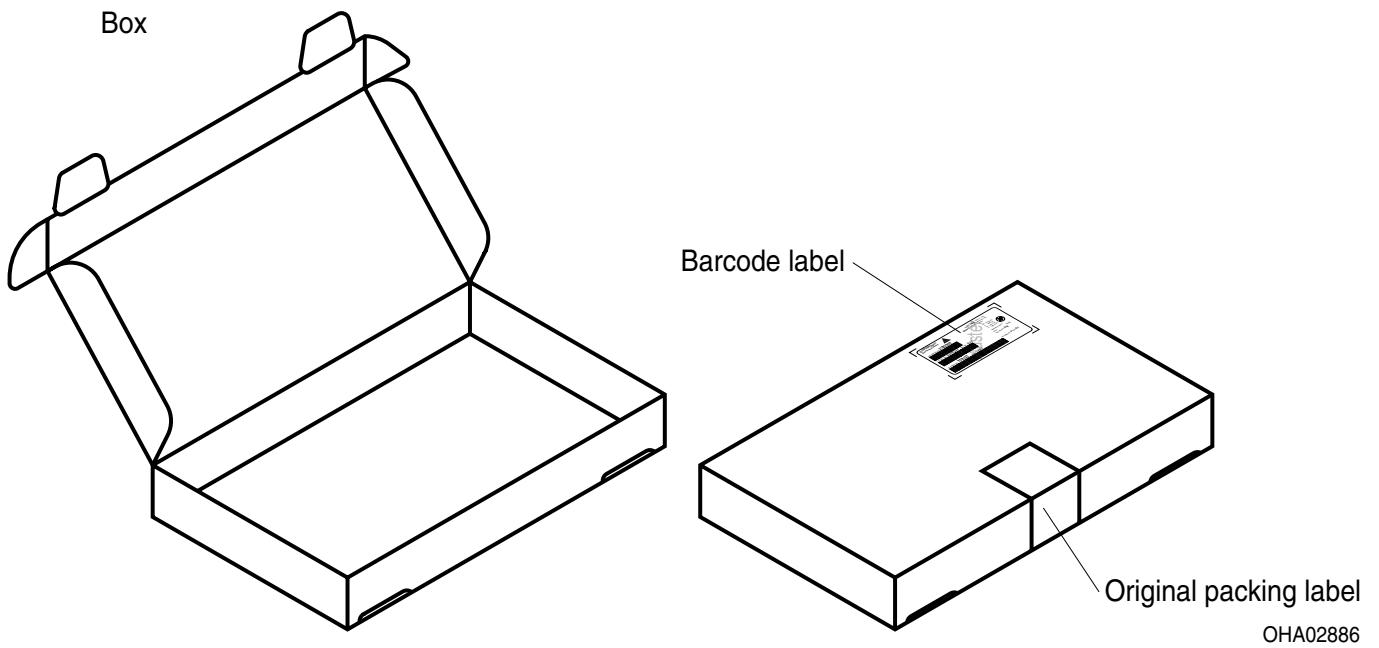

Dimensions of Transportation Box

Width	Length	Height
333 ± 5 mm	218 ± 5 mm	28 ± 5 mm
337 ± 5 mm	218 ± 5 mm	63 ± 5 mm

Type Designation System

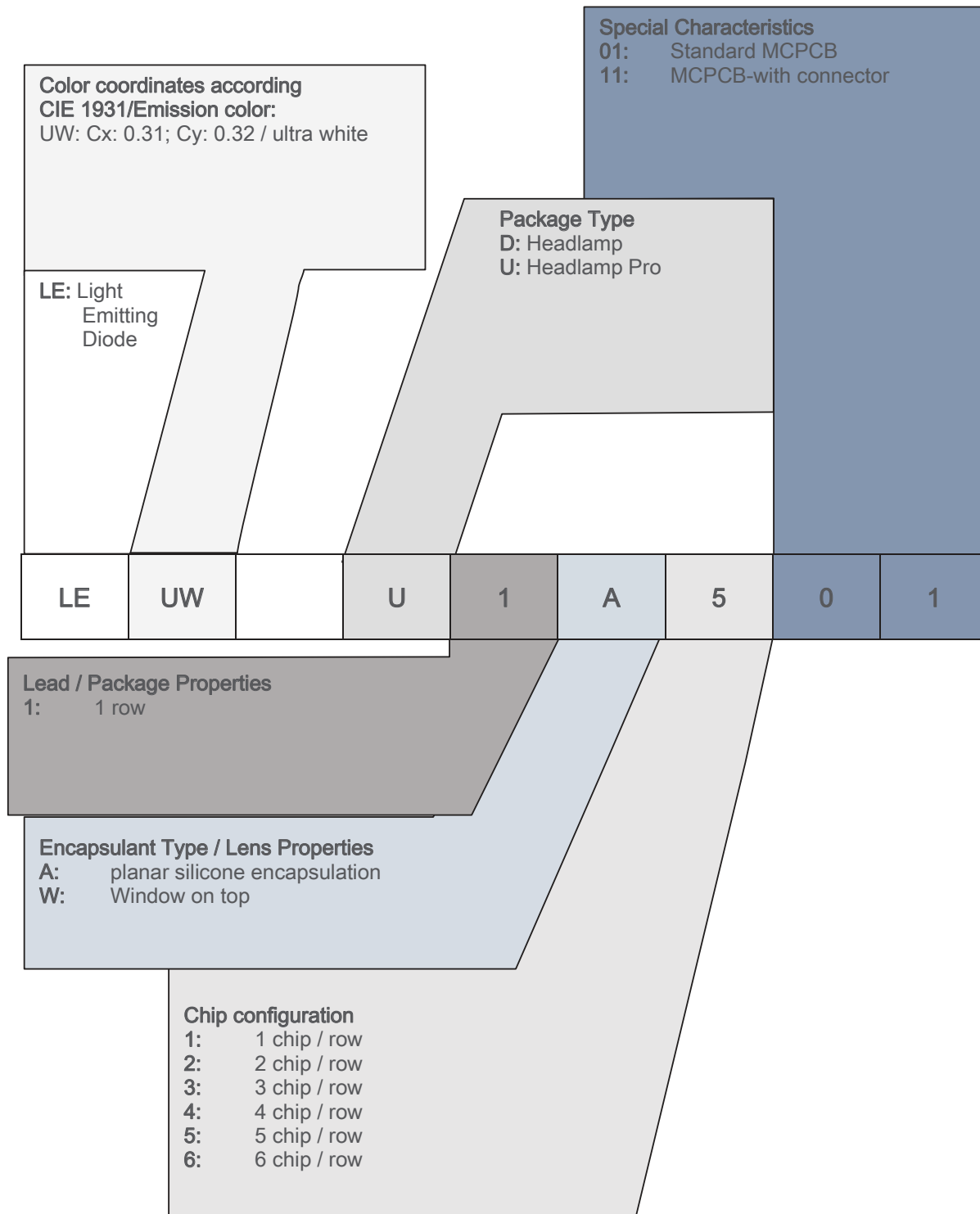

Not for new design

Notes

The evaluation of eye safety occurs according to the standard IEC 62471:2006 (photo biological safety of lamps and lamp systems). Within the risk grouping system of this IEC standard, the device specified in this data sheet fall into the class **moderate risk (exposure time 0.25 s)**. Under real circumstances (for exposure time, conditions of the eye pupils, observation distance), it is assumed that no endangerment to the eye exists from these devices. As a matter of principle, however, it should be mentioned that intense light sources have a high secondary exposure potential due to their blinding effect. When looking at bright light sources (e.g. headlights), temporary reduction in visual acuity and afterimages can occur, leading to irritation, annoyance, visual impairment, and even accidents, depending on the situation.

Subcomponents of this device contain, in addition to other substances, metal filled materials including silver. Metal filled materials can be affected by environments that contain traces of aggressive substances. Therefore, we recommend that customers minimize device exposure to aggressive substances during storage, production, and use. Devices that showed visible discoloration when tested using the described tests above did show no performance deviations within failure limits during the stated test duration. Respective failure limits are described in the IEC60810.

For further application related information please visit www.osram-os.com/appnotes

Disclaimer

Attention please!

The information describes the type of component and shall not be considered as assured characteristics. Terms of delivery and rights to change design reserved. Due to technical requirements components may contain dangerous substances.

For information on the types in question please contact our Sales Organization.

If printed or downloaded, please find the latest version on the OSRAM OS website.

Packing

Please use the recycling operators known to you. We can also help you – get in touch with your nearest sales office. By agreement we will take packing material back, if it is sorted. You must bear the costs of transport. For packing material that is returned to us unsorted or which we are not obliged to accept, we shall have to invoice you for any costs incurred.

Product and functional safety devices/applications or medical devices/applications

OSRAM OS components are not developed, constructed or tested for the application as safety relevant component or for the application in medical devices.

OSRAM OS products are not qualified at module and system level for such application.

In case buyer – or customer supplied by buyer – considers using OSRAM OS components in product safety devices/applications or medical devices/applications, buyer and/or customer has to inform the local sales partner of OSRAM OS immediately and OSRAM OS and buyer and /or customer will analyze and coordinate the customer-specific request between OSRAM OS and buyer and/or customer.

Glossary

- 1) **Brightness:** Brightness values are measured during a current pulse of typically 25 ms, with an internal reproducibility of $\pm 8\%$ and an expanded uncertainty of $\pm 11\%$ (acc. to GUM with a coverage factor of $k = 3$).
- 2) **Reverse Operation:** This product is intended to be operated applying a forward current within the specified range. Applying any continuous reverse bias or forward bias below the voltage range of light emission shall be avoided because it may cause migration which can change the electro-optical characteristics or damage the LED.
- 3) **Chromaticity coordinate groups:** Chromaticity coordinates are measured during a current pulse of typically 25 ms, with an internal reproducibility of ± 0.005 and an expanded uncertainty of ± 0.01 (acc. to GUM with a coverage factor of $k = 3$).
- 4) **Forward Voltage:** The forward voltage is measured during a current pulse of typically 8 ms, with an internal reproducibility of ± 0.05 V and an expanded uncertainty of ± 0.1 V (acc. to GUM with a coverage factor of $k = 3$).
- 5) **Thermal Resistance:** $R_{th\ max}$ is based on statistic values (6σ).
- 6) **Typical Values:** Due to the special conditions of the manufacturing processes of semiconductor devices, the typical data or calculated correlations of technical parameters can only reflect statistical figures. These do not necessarily correspond to the actual parameters of each single product, which could differ from the typical data and calculated correlations or the typical characteristic line. If requested, e.g. because of technical improvements, these typ. data will be changed without any further notice.
- 7) **Characteristic curve:** In the range where the line of the graph is broken, you must expect higher differences between single devices within one packing unit.
- 8) **Tolerance of Measure:** Unless otherwise noted in drawing, tolerances are specified with ± 0.1 and dimensions are specified in mm.

Revision History

Version	Date	Change
1.5	2020-06-03	Features Dimensions of Transportation Box Type Designation System Disclaimer
1.6	2021-02-19	Chromaticity Coordinate Groups Notes Glossary Not for new design

Published by OSRAM Opto Semiconductors GmbH EU RoHS and China RoHS compliant product
Leibnizstraße 4, D-93055 Regensburg
www.osram-os.com © All Rights Reserved.



此产品符合欧盟 RoHS 指令的要求；
按照中国的相关法规和标准，不含有毒有害物质或元素。