



Bridgelux® Gen 8 Vero® 18 Array

Product Data Sheet DS422



Introduction

Vero® Series



The Vero® Series is a revolutionary advancement in chip on board (COB) light source technology and innovation, simplifying the luminaire design and manufacturing processes. Vero Chip on Board (COB) LED arrays are available in four LES configurations, engineered to enable new degrees of flexibility and reliability over a broad range of electrical currents. Vero arrays deliver increased lumen density to enable improved beam control and precision lighting with 2 and 3 SDCM color control standard for clean and consistent uniform lighting.

Vero products include an onboard connector port that enables a solder-free electrical interconnect, and simple mounting features for plug-and-play installation.

Features

- On board connector port
- Top side part number markings
- Efficacy of 180 lm/W typical, 3000K 80 CRI
- Reliable operation at up to 3x nominal current, 30% increase in maximum lumens per LES size
- Wide selection of CCT options (2700K-6500K) with minimum 70, 80 and 90 CRI options
- Uniform high-quality illumination
- 2 and 3 SDCM binning options (2700K – 4000K)
- Forward voltage bin codes (backside marking)
- Thermally isolated solder pads
- 10-Year warranty

Benefits

- Solder free installation and field upgradability
- Improved inventory management and quality control
- Enables high efficiency lighting systems and lower operating costs
- Supports the trend toward luminaire miniaturization and delivers enhanced optical control
- Design flexibility for a broad range of lighting applications
- Clean white light without pixelation
- Uniform consistent white light
- Design flexibility for multi-source applications
- Enhanced ease of use and installation
- Design with confidence

Contents

Product Feature Map	2
Product Nomenclature	2
Product Selection Guide	3
Performance at Commonly Used Drive Currents	7
Electrical Characteristics	16
Eye Safety	17
Absolute Maximum Ratings	18
Performance Curves	19
Typical Radiation Pattern	21
Typical Color Spectrum	22
Mechanical Dimensions	23
Color Binning Information	24
Packaging and Labeling	25
Design Resources	27
Precautions	27
Disclaimers	27
About Bridgelux	28

Product Feature Map

Vero 18 is the second largest form factor in the Vero family of next generation solid state light sources. In addition to delivering the performance and light quality required for many lighting applications, Vero incorporates

several features to simplify the design integration and manufacturing process, accelerate time to market and reduce system costs. Please visit www.bridgelux.com for more information on the Vero Series family of products.

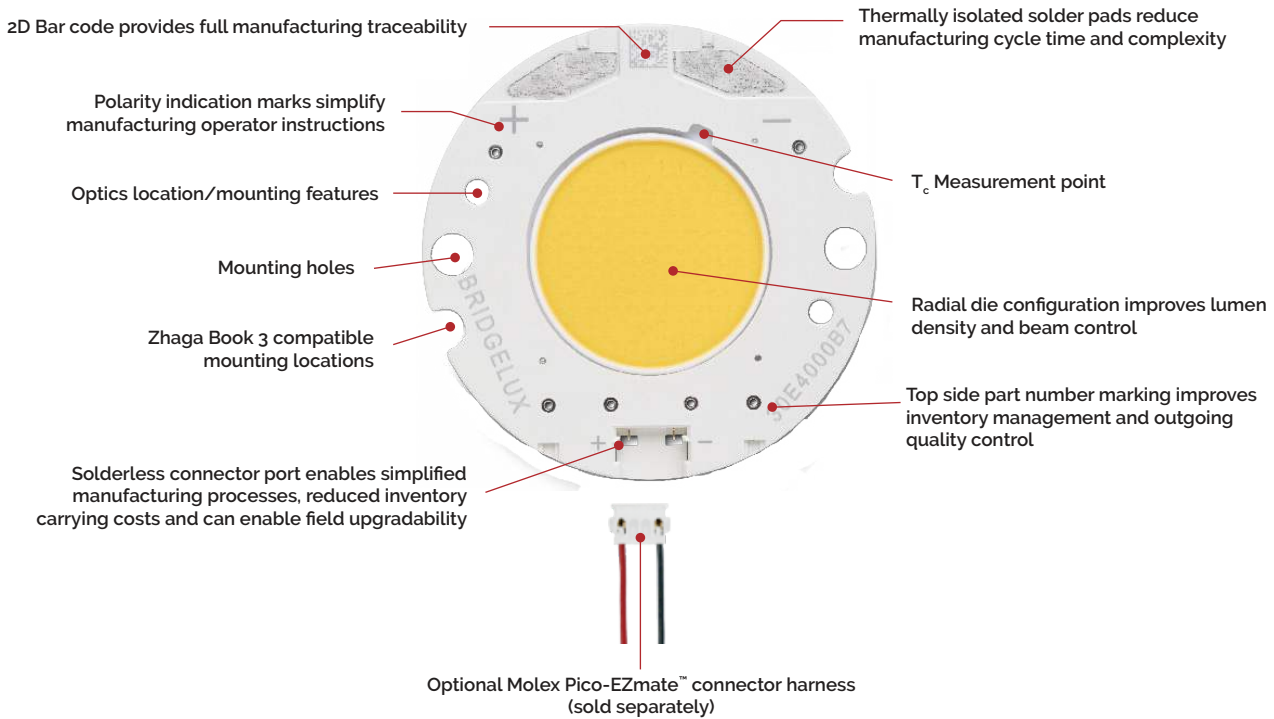

Product Nomenclature

The part number designation for Bridgelux Vero LED arrays is explained as follows:

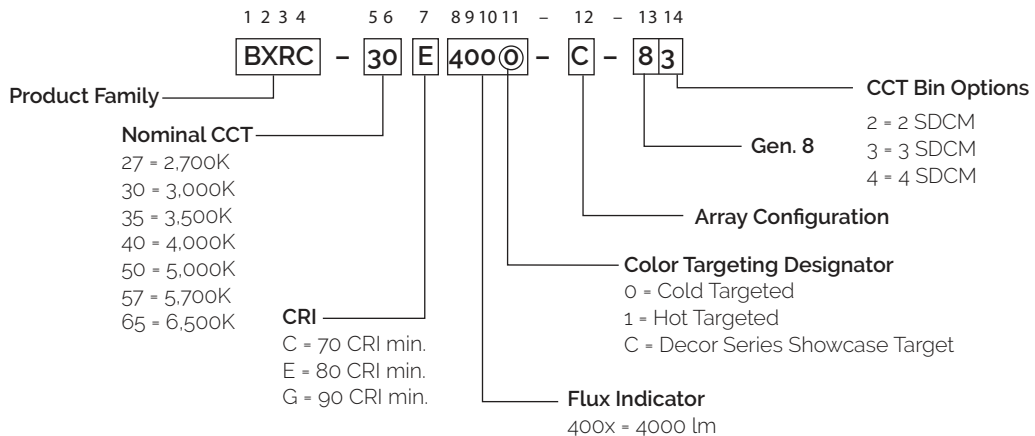

Product Selection Guide

The following product configurations are available:

Table 1: Selection Guide, Pulsed Measurement Data ($T_j = T_c = 25^\circ\text{C}$)

Part Number	Nominal CCT ¹ (K)	CRI ²	Nominal Drive Current ³ (mA)	Typical Pulsed Flux ^{4,5,6} $T_c = 25^\circ\text{C}$ (lm)	Minimum Pulsed Flux ^{6,7} $T_c = 25^\circ\text{C}$ (lm)	Typical V_f (V)	Typical Power (W)	Typical Efficacy (lm/W)
BXRC-27E4000-B-8x	2700	80	700	4028	3625	33.9	23.7	170
BXRC-27E4000-C-8x	2700	80	1050	6024	5421	33.9	35.6	169
BXRC-27E4000-D-8x	2700	80	850	4055	3649	28.2	24.0	169
BXRC-27G4000-B-8x	2700	90	700	3323	2991	33.9	23.7	140
BXRC-27G4000-C-8x	2700	90	1050	4969	4472	33.9	35.6	140
BXRC-27G4000-D-8x	2700	90	850	3345	3011	28.2	24.0	140
BXRC-27G40H0-B-8x	2700	90	700	3467	3120	33.9	23.7	146
BXRC-27G40H0-C-8x	2700	90	1050	5184	4666	33.9	35.6	146
BXRC-27G40H0-D-8x	2700	90	850	3489	3141	28.2	24.0	146
BXRC-30C4001-B-8x	3000	70	700	4481	4033	33.9	23.7	189
BXRC-30C4001-C-8x	3000	70	1050	6701	6031	33.9	35.6	188
BXRC-30C4001-D-8x	3000	70	850	4511	4060	28.2	24.0	188
BXRC-30E4000-B-8x	3000	80	700	4280	3852	33.9	23.7	180
BXRC-30E4000-C-8x	3000	80	1050	6400	5760	33.9	35.6	180
BXRC-30E4000-D-8x	3000	80	850	4308	3877	28.2	24.0	180
BXRC-30G4000-B-8x	3000	90	700	3474	3127	33.9	23.7	146
BXRC-30G4000-C-8x	3000	90	1050	5195	4676	33.9	35.6	146
BXRC-30G4000-D-8x	3000	90	850	3497	3147	28.2	24.0	146
BXRC-30G40H0-B-8x	3000	90	700	3638	3274	33.9	23.7	153
BXRC-30G40H0-C-8x	3000	90	1050	5440	4896	33.9	35.6	153
BXRC-30G40H0-D-8x	3000	90	850	3662	3296	28.2	24.0	153
BXRC-35E4000-B-8x	3500	80	700	4381	3943	33.9	23.7	185
BXRC-35E4000-C-8x	3500	80	1050	6551	5896	33.9	35.6	184
BXRC-35E4000-D-8x	3500	80	850	4409	3968	28.2	24.0	184
BXRC-35G4000-B-8x	3500	90	700	3600	3240	33.9	23.7	152
BXRC-35G4000-C-8x	3500	90	1050	5384	4845	33.9	35.6	151
BXRC-35G4000-D-8x	3500	90	850	3624	3261	28.2	24.0	151
BXRC-40C4001-B-8x	4000	70	700	4607	4147	33.9	23.7	194
BXRC-40C4001-C-8x	4000	70	1050	6889	6200	33.9	35.6	194
BXRC-40C4001-D-8x	4000	70	850	4637	4174	28.2	24.0	193
BXRC-40E4000-B-8x	4000	80	700	4406	3965	33.9	23.7	186
BXRC-40E4000-C-8x	4000	80	1050	6588	5929	33.9	35.6	185
BXRC-40E4000-D-8x	4000	80	850	4435	3991	28.2	24.0	185
BXRC-40G4000-B-8x	4000	90	700	3676	3308	33.9	23.7	155
BXRC-40G4000-C-8x	4000	90	1050	5496	4947	33.9	35.6	154
BXRC-40G4000-D-8x	4000	90	850	3700	3330	28.2	24.0	154

Notes for Table 1:

- Nominal CCT as defined by ANSI C78.377-2011. Products with a CCT of 5000K-6500K are hot targeted to $T_c = 85^\circ\text{C}$.
- CRI values are minimums for all products. Minimum R_g value for 80 CRI products is 0, the minimum R_g value for 90 CRI products is 50. Bridgelux maintains a ± 3 tolerance on CRI and R_g values.
- Drive current is referred to as nominal drive current.
- Products tested under pulsed condition (10ms pulse width) at nominal test current where T_j (junction temperature) - T_c (case temperature) = 25°C .
- Typical performance values are provided as a reference only and are not a guarantee of performance.
- Bridgelux maintains a $\pm 7\%$ tolerance on flux measurements.
- Minimum flux values at the nominal test current are guaranteed by 100% test.

Product Selection Guide

Table 1: Selection Guide, Pulsed Measurement Data ($T_j = T_c = 25^\circ\text{C}$) (continued)

Part Number	Nominal CCT ¹ (K)	CRI ²	Nominal Drive Current ³ (mA)	Typical Pulsed Flux ^{4,5,6} $T_c = 25^\circ\text{C}$ (lm)	Minimum Pulsed Flux ^{6,7} $T_c = 25^\circ\text{C}$ (lm)	Typical V_f (V)	Typical Power (W)	Typical Efficacy (lm/W)
BXRC-50C4001-B-8x	5000	70	700	4632	4169	33.9	23.7	195
BXRC-50C4001-C-8x	5000	70	1050	6927	6234	33.9	35.6	195
BXRC-50C4001-D-8x	5000	70	850	4663	4196	28.2	24.0	195
BXRC-50E4001-B-8x	5000	80	700	4456	4011	33.9	23.7	188
BXRC-50E4001-C-8x	5000	80	1050	6664	5997	33.9	35.6	187
BXRC-50E4001-D-8x	5000	80	850	4485	4037	28.2	24.0	187
BXRC-50G4001-B-8x	5000	90	700	3852	3467	33.9	23.7	162
BXRC-50G4001-C-8x	5000	90	1050	5760	5184	33.9	35.6	162
BXRC-50G4001-D-8x	5000	90	850	3877	3489	28.2	24.0	162
BXRC-57C4001-B-8x	5700	70	700	4507	4056	33.9	23.7	190
BXRC-57C4001-C-8x	5700	70	1050	6739	6065	33.9	35.6	189
BXRC-57C4001-D-8x	5700	70	850	4536	4082	28.2	24.0	189
BXRC-57E4001-B-8x	5700	80	700	4280	3852	33.9	23.7	180
BXRC-57E4001-C-8x	5700	80	1050	6400	5760	33.9	35.6	180
BXRC-57E4001-D-8x	5700	80	850	4308	3877	28.2	24.0	180
BXRC-65C4001-B-8x	6500	70	700	4507	4056	33.9	23.7	190
BXRC-65C4001-C-8x	6500	70	1050	6739	6065	33.9	35.6	189
BXRC-65C4001-D-8x	6500	70	850	4536	4082	28.2	24.0	189
BXRC-65E4001-B-8x	6500	80	700	4330	3897	33.9	23.7	182
BXRC-65E4001-C-8x	6500	80	1050	6475	5828	33.9	35.6	182
BXRC-65E4001-D-8x	6500	80	850	4359	3923	28.2	24.0	182

Notes for Table 1:

1. Nominal CCT as defined by ANSI C78.377-2011. Products with a CCT of 5000K-6500K are hot targeted to $T_c = 85^\circ\text{C}$.
2. CRI values are minimums for all products. Minimum R₉ value for 80 CRI products is 0, the minimum R₉ value for 90 CRI products is 50. Bridgelux maintains a ± 3 tolerance for all CRI and R₉ values.
3. Drive current is referred to as nominal drive current.
4. Products tested under pulsed condition (10ms pulse width) at nominal test current where T_j (junction temperature) - T_c (case temperature) = 25°C .
5. Typical performance values are provided as a reference only and are not a guarantee of performance.
6. Bridgelux maintains a $\pm 7\%$ tolerance on flux measurements.
7. Minimum flux values at the nominal test current are guaranteed by 100% test.

Product Selection Guide

Table 2: Selection Guide, Stabilized DC Performance ($T_c = 85^\circ\text{C}$)^{4,5}

Part Number	Nominal CCT ¹ (K)	CRI ²	Nominal Drive Current ³ (mA)	Typical DC Flux ^{4,5} $T_c = 85^\circ\text{C}$ (lm)	Minimum DC Flux ⁶ $T_c = 85^\circ\text{C}$ (lm)	Typical V_f (V)	Typical Power (W)	Typical Efficacy (lm/W)
BXRC-27E4000-B-8x	2700	80	700	3625	3263	33.1	23.2	156
BXRC-27E4000-C-8x	2700	80	1050	5421	4879	33.1	34.8	156
BXRC-27E4000-D-8x	2700	80	850	3649	3284	27.7	23.5	155
BXRC-27G4000-B-8x	2700	90	700	2991	2692	33.1	23.2	129
BXRC-27G4000-C-8x	2700	90	1050	4472	4025	33.1	34.8	129
BXRC-27G4000-D-8x	2700	90	850	3011	2709	27.7	23.5	128
BXRC-27G40H0-B-8x	2700	90	700	3120	2808	33.1	23.2	135
BXRC-27G40H0-C-8x	2700	90	1050	4666	4199	33.1	34.8	134
BXRC-27G40H0-D-8x	2700	90	850	3141	2826	27.7	23.5	134
BXRC-30C4001-B-8x	3000	70	700	4033	3630	33.1	23.2	174
BXRC-30C4001-C-8x	3000	70	1050	6031	5428	33.1	34.8	173
BXRC-30C4001-D-8x	3000	70	850	4060	3654	27.7	23.5	173
BXRC-30E4000-B-8x	3000	80	700	3852	3467	33.1	23.2	166
BXRC-30E4000-C-8x	3000	80	1050	5760	5184	33.1	34.8	166
BXRC-30E4000-D-8x	3000	80	850	3877	3489	27.7	23.5	165
BXRC-30G4000-B-8x	3000	90	700	3127	2814	33.1	23.2	135
BXRC-30G4000-C-8x	3000	90	1050	4676	4208	33.1	34.8	134
BXRC-30G4000-D-8x	3000	90	850	3147	2833	27.7	23.5	134
BXRC-30G40H0-B-8x	3000	90	700	3274	2947	33.1	23.2	141
BXRC-30G40H0-C-8x	3000	90	1050	4896	4406	33.1	34.8	141
BXRC-30G40H0-D-8x	3000	90	850	3296	2966	27.7	23.5	140
BXRC-35E4000-B-8x	3500	80	700	3943	3548	33.1	23.2	170
BXRC-35E4000-C-8x	3500	80	1050	5896	5306	33.1	34.8	170
BXRC-35E4000-D-8x	3500	80	850	3968	3572	27.7	23.5	169
BXRC-35G4000-B-8x	3500	90	700	3240	2916	33.1	23.2	140
BXRC-35G4000-C-8x	3500	90	1050	4845	4361	33.1	34.8	139
BXRC-35G4000-D-8x	3500	90	850	3261	2935	27.7	23.5	139
BXRC-40C4001-B-8x	4000	70	700	4147	3732	33.1	23.2	179
BXRC-40C4001-C-8x	4000	70	1050	6200	5580	33.1	34.8	178
BXRC-40C4001-D-8x	4000	70	850	4174	3756	27.7	23.5	178
BXRC-40E4000-B-8x	4000	80	700	3965	3569	33.1	23.2	171
BXRC-40E4000-C-8x	4000	80	1050	5929	5336	33.1	34.8	171
BXRC-40E4000-D-8x	4000	80	850	3991	3592	27.7	23.5	170
BXRC-40G4000-B-8x	4000	90	700	3308	2977	33.1	23.2	143
BXRC-40G4000-C-8x	4000	90	1050	4947	4452	33.1	34.8	142
BXRC-40G4000-D-8x	4000	90	850	3330	2997	27.7	23.5	142

Notes for Table 2:

- Nominal CCT as defined by ANSI C78.377-2011. Products with a CCT of 5000K-6500K are hot targeted to $T_c = 85^\circ\text{C}$.
- CRI values are minimums for all products. Minimum Rg value for 80 CRI products is 0, the minimum Rg value for 90 CRI products is 50. Bridgelux maintains a ± 3 tolerance for all CRI and Rg values.
- Drive current is referred to as nominal drive current.
- Typical stabilized DC performance values are provided as reference only and are not a guarantee of performance.
- Typical performance is estimated based on operation under DC (direct current) with LED array mounted onto a heat sink with thermal interface material and the case temperature maintained at 85°C . Based on Bridgelux test setup, values may vary depending on the thermal design of the luminaire and/or the exposed environment to which the product is subjected.
- Minimum flux values at elevated temperatures are provided for reference only and are not guaranteed by 100% production testing. Based on Bridgelux test setup, values may vary depending on the thermal design of the luminaire and/or the exposed environment to which the product is subjected.

Product Selection Guide

Table 2: Selection Guide, Stabilized DC Performance ($T_c = 85^\circ\text{C}$)^{4,5} (continued)

Part Number	Nominal CCT ¹ (K)	CRI ²	Nominal Drive Current ³ (mA)	Typical DC Flux ^{4,5} $T_c = 85^\circ\text{C}$ (lm)	Minimum DC Flux ⁶ $T_c = 85^\circ\text{C}$ (lm)	Typical V_f (V)	Typical Power (W)	Typical Efficacy (lm/W)
BXRC-50C4001-B-8x	5000	70	700	4169	3752	33.1	23.2	180
BXRC-50C4001-C-8x	5000	70	1050	6234	5611	33.1	34.8	179
BXRC-50C4001-D-8x	5000	70	850	4196	3777	27.7	23.5	178
BXRC-50E4001-B-8x	5000	80	700	4011	3610	33.1	23.2	173
BXRC-50E4001-C-8x	5000	80	1050	5997	5397	33.1	34.8	172
BXRC-50E4001-D-8x	5000	80	850	4037	3633	27.7	23.5	172
BXRC-50G4001-B-8x	5000	90	700	3467	3120	33.1	23.2	150
BXRC-50G4001-C-8x	5000	90	1050	5184	4666	33.1	34.8	149
BXRC-50G4001-D-8x	5000	90	850	3489	3141	27.7	23.5	148
BXRC-57C4001-B-8x	5700	70	700	4056	3650	33.1	23.2	175
BXRC-57C4001-C-8x	5700	70	1050	6065	5458	33.1	34.8	174
BXRC-57C4001-D-8x	5700	70	850	4082	3674	27.7	23.5	174
BXRC-57E4001-B-8x	5700	80	700	3852	3467	33.1	23.2	166
BXRC-57E4001-C-8x	5700	80	1050	5760	5184	33.1	34.8	166
BXRC-57E4001-D-8x	5700	80	850	3877	3489	27.7	23.5	165
BXRC-65C4001-B-8x	6500	70	700	4056	3650	33.1	23.2	175
BXRC-65C4001-C-8x	6500	70	1050	6065	5458	33.1	34.8	174
BXRC-65C4001-D-8x	6500	70	850	4082	3674	27.7	23.5	174
BXRC-65E4001-B-8x	6500	80	700	3897	3508	33.1	23.2	168
BXRC-65E4001-C-8x	6500	80	1050	5828	5245	33.1	34.8	168
BXRC-65E4001-D-8x	6500	80	850	3923	3531	27.7	23.5	167

Notes for Table 2:

- Nominal CCT as defined by ANSI C78.377-2011. Products with a CCT of 5000K-6500K are hot targeted to $T_c = 85^\circ\text{C}$.
- CRI values are minimums for all products. Minimum Rg value for 80 CRI products is 0, the minimum Rg value for 90 CRI products is 50. Bridgelux maintains a ± 3 tolerance for all CRI and Rg values.
- Drive current is referred to as nominal drive current.
- Typical stabilized DC performance values are provided as reference only and are not a guarantee of performance.
- Typical performance is estimated based on operation under DC (direct current) with LED array mounted onto a heat sink with thermal interface material and the case temperature maintained at 85°C . Based on Bridgelux test setup, values may vary depending on the thermal design of the luminaire and/or the exposed environment to which the product is subjected.
- Minimum flux values at elevated temperatures are provided for reference only and are not guaranteed by 100% production testing. Based on Bridgelux test setup, values may vary depending on the thermal design of the luminaire and/or the exposed environment to which the product is subjected.

Performance at Commonly Used Drive Currents

Vero LED arrays are tested to the specifications shown using the nominal drive currents in Table 1. Vero may also be driven at other drive currents dependent on specific application design requirements. The performance at any drive current can be derived from the current vs. voltage characteristics shown in Figures 1, 2 & 3 and the flux vs. current characteristics shown in Figures 4, 5 & 6. The performance at commonly used drive currents is summarized in Table 3.

Table 3: Product Performance at Commonly Used Drive Currents

Part Number	CRI	Drive Current ¹ (mA)	Typical V _f T _c = 25°C (V)	Typical Power T _c = 25°C (W)	Typical Flux ² T _c = 25°C (lm)	Typical DC Flux ³ T _c = 85°C (lm)	Typical Efficacy T _c = 25°C (lm/W)
BXRC-27E4000-B-8x	80	350	32.7	11.4	2115	1903	185
		525	33.3	17.5	3065	2759	175
		700	33.9	23.7	4028	3625	170
		900	34.5	31.0	5053	4548	163
		1400	36.0	50.4	7600	6840	151
		2000	37.5	75.1	10500	9450	140
BXRC-27E4000-C-8x	80	525	32.7	17.2	3162	2846	184
		785	33.3	26.1	4570	4113	175
		1050	33.9	35.6	6024	5421	169
		1170	34.1	39.9	6616	5954	166
		2100	36.0	75.5	11365	10228	150
		3000	37.5	112.6	15700	14130	139
BXRC-27E4000-D-8x	80	425	27.2	11.6	2128	1916	184
		650	27.7	18.0	3141	2827	174
		850	28.2	23.9	4055	3649	169
		1050	28.6	30.0	4901	4411	163
		1700	29.9	50.9	7650	6885	150
		2500	31.3	78.3	10845	9761	138
BXRC-27G4000-B-8x	90	350	32.7	11.4	1745	1570	153
		525	33.3	17.5	2529	2276	145
		700	33.9	23.7	3323	2991	140
		900	34.5	31.0	4169	3752	134
		1400	36.0	50.4	6270	5643	125
		2000	37.5	75.1	8662	7796	115
BXRC-27G4000-C-8x	90	525	32.7	17.2	2609	2348	152
		785	33.3	26.1	3770	3393	144
		1050	33.9	35.6	4969	4472	140
		1170	34.1	39.9	5458	4912	137
		2100	36.0	75.5	9376	8438	124
		3000	37.5	112.6	12953	11658	115
BXRC-27G4000-D-8x	90	425	27.2	11.6	1756	1580	152
		650	27.7	18.0	2591	2332	144
		850	28.2	23.9	3345	3011	140
		1050	28.6	30.0	4043	3639	135
		1700	29.9	50.9	6311	5680	124
		2500	31.3	78.3	8947	8053	114

Notes for Table 3:

1. Alternate drive currents in Table 3 are provided for reference only and are not a guarantee of performance.
2. Bridgelux maintains a ± 7% tolerance on flux measurements.
3. Typical stabilized DC performance values are provided as reference only and are not a guarantee of performance.

Performance at Commonly Used Drive Currents

Table 3: Product Performance at Commonly Used Drive Currents (Continued)

Part Number	CRI	Drive Current ¹ (mA)	Typical V _f T _c = 25°C (V)	Typical Power T _c = 25°C (W)	Typical Flux ² T _c = 25°C (lm)	Typical DC Flux ³ T _c = 85°C (lm)	Typical Efficacy T _c = 25°C (lm/W)
BXRC-27G40H0-B-8x	90	350	32.7	11.4	1820	1638	159
		525	33.3	17.5	2638	2374	151
		700	33.9	23.7	3467	3120	146
		900	34.5	31.0	4349	3914	140
		1400	36.0	50.4	6541	5887	130
		2000	37.5	75.1	9036	8133	120
BXRC-27G40H0-C-8x	90	525	32.7	17.2	2721	2449	159
		785	33.3	26.1	3933	3540	151
		1050	33.9	35.6	5184	4666	146
		1170	34.1	39.9	5694	5125	143
		2100	36.0	75.5	9781	8803	129
		3000	37.5	112.6	13512	12161	120
BXRC-27G40H0-D-8x	90	425	27.2	11.6	1832	1649	159
		650	27.7	18.0	2703	2433	150
		850	28.2	23.9	3489	3141	146
		1050	28.6	30.0	4218	3796	140
		1700	29.9	50.9	6584	5925	129
		2500	31.3	78.3	9334	8400	119
BXRC-30C4001-B-8x	70	350	32.7	11.4	2353	2117	206
		525	33.3	17.5	3410	3069	195
		700	33.9	23.7	4481	4033	189
		900	34.5	31.0	5622	5060	181
		1400	36.0	50.4	8455	7610	168
		2000	37.5	75.1	11681	10513	156
BXRC-30C4001-C-8x	70	525	32.7	17.2	3518	3166	205
		785	33.3	26.1	5084	4576	195
		1050	33.9	35.6	6701	6031	188
		1170	34.1	39.9	7360	6624	184
		2100	36.0	75.5	12643	11379	167
		3000	37.5	112.6	17467	15720	155
BXRC-30C4001-D-8x	70	425	27.2	11.6	2368	2131	205
		650	27.7	18.0	3495	3145	194
		850	28.2	23.9	4511	4060	188
		1050	28.6	30.0	5452	4907	182
		1700	29.9	50.9	8511	7660	167
		2500	31.3	78.3	12065	10859	154
BXRC-30E4000-B-8x	80	350	32.7	11.4	2247	2022	196
		525	33.3	17.5	3257	2931	186
		700	33.9	23.7	4280	3852	181
		900	34.5	31.0	5369	4832	173
		1400	36.0	50.4	8075	7268	160
		2000	37.5	75.1	11156	10040	149

Notes for Table 3:

1. Alternate drive currents in Table 3 are provided for reference only and are not a guarantee of performance.
2. Bridgelux maintains a ± 7% tolerance on flux measurements.
3. Typical stabilized DC performance values are provided as reference only and are not a guarantee of performance.

Performance at Commonly Used Drive Currents

Table 3: Product Performance at Commonly Used Drive Currents (Continued)

Part Number	CRI	Drive Current ¹ (mA)	Typical V _f T _c = 25°C (V)	Typical Power T _c = 25°C (W)	Typical Flux ² T _c = 25°C (lm)	Typical DC Flux ³ T _c = 85°C (lm)	Typical Efficacy T _c = 25°C (lm/W)
BXRC-30E4000-C-8x	80	525	32.7	17.2	3360	3024	196
		785	33.3	26.1	4856	4370	186
		1050	33.9	35.6	6400	5760	180
		1170	34.1	39.9	7030	6327	176
		2100	36.0	75.5	12075	10868	160
		3000	37.5	112.6	16682	15013	148
BXRC-30E4000-D-8x	80	425	27.2	11.6	2262	2035	196
		650	27.7	18.0	3338	3004	185
		850	28.2	23.9	4308	3877	180
		1050	28.6	30.0	5207	4687	173
		1700	29.9	50.9	8128	7315	160
		2500	31.3	78.3	11523	10371	147
BXRC-30G4000-B-8x	90	350	32.7	11.4	1824	1641	159
		525	33.3	17.5	2644	2379	151
		700	33.9	23.7	3474	3127	147
		900	34.5	31.0	4359	3923	140
		1400	36.0	50.4	6555	5900	130
		2000	37.5	75.1	9056	8150	121
BXRC-30G4000-C-8x	90	525	32.7	17.2	2727	2455	159
		785	33.3	26.1	3942	3548	151
		1050	33.9	35.6	5195	4676	146
		1170	34.1	39.9	5706	5136	143
		2100	36.0	75.5	9802	8822	130
		3000	37.5	112.6	13542	12187	120
BXRC-30G4000-D-8x	90	425	27.2	11.6	1836	1652	159
		650	27.7	18.0	2709	2438	150
		850	28.2	23.9	3497	3147	146
		1050	28.6	30.0	4227	3804	141
		1700	29.9	50.9	6598	5938	130
		2500	31.3	78.3	9354	8419	119
BXRC-30G40H0-B-8x	90	350	32.7	11.4	1910	1719	167
		525	33.3	17.5	2768	2492	158
		700	33.9	23.7	3638	3274	153
		900	34.5	31.0	4564	4108	147
		1400	36.0	50.4	6864	6178	136
		2000	37.5	75.1	9482	8534	126
BXRC-30G40H0-C-8x	90	525	32.7	17.2	2856	2570	166
		785	33.3	26.1	4127	3715	158
		1050	33.9	35.6	5440	4896	153
		1170	34.1	39.9	5975	5378	150
		2100	36.0	75.5	10264	9238	136
		3000	37.5	112.6	14179	12761	126

Notes for Table 3:

1. Alternate drive currents in Table 3 are provided for reference only and are not a guarantee of performance.
2. Bridgelux maintains a ± 7% tolerance on flux measurements.
3. Typical stabilized DC performance values are provided as reference only and are not a guarantee of performance.

Performance at Commonly Used Drive Currents

Table 3: Product Performance at Commonly Used Drive Currents (Continued)

Part Number	CRI	Drive Current ¹ (mA)	Typical V _f T _c = 25°C (V)	Typical Power T _c = 25°C (W)	Typical Flux ² T _c = 25°C (lm)	Typical DC Flux ³ T _c = 85°C (lm)	Typical Efficacy T _c = 25°C (lm/W)
BXRC-30G40H0-D-8x	90	425	27.2	11.6	1922	1730	166
		650	27.7	18.0	2837	2553	158
		850	28.2	23.9	3662	3296	153
		1050	28.6	30.0	4426	3984	147
		1700	29.9	50.9	6909	6218	136
		2500	31.3	78.3	9795	8815	125
BXRC-35E4000-B-8x	80	350	32.7	11.4	2300	2070	201
		525	33.3	17.5	3334	3000	191
		700	33.9	23.7	4381	3943	185
		900	34.5	31.0	5496	4946	177
		1400	36.0	50.4	8265	7439	164
		2000	37.5	75.1	11418	10276	152
BXRC-35E4000-C-8x	80	525	32.7	17.2	3439	3095	200
		785	33.3	26.1	4970	4473	190
		1050	33.9	35.6	6551	5896	184
		1170	34.1	39.9	7195	6476	180
		2100	36.0	75.5	12359	11123	164
		3000	37.5	112.6	17074	15367	152
BXRC-35E4000-D-8x	80	425	27.2	11.6	2315	2083	200
		650	27.7	18.0	3416	3074	190
		850	28.2	23.9	4409	3968	184
		1050	28.6	30.0	5330	4797	178
		1700	29.9	50.9	8319	7487	164
		2500	31.3	78.3	11794	10615	151
BXRC-35G4000-B-8x	90	350	32.7	11.4	1890	1701	165
		525	33.3	17.5	2740	2466	157
		700	33.9	23.7	3600	3240	152
		900	34.5	31.0	4517	4065	145
		1400	36.0	50.4	6793	6113	135
		2000	37.5	75.1	9384	8446	125
BXRC-35G4000-C-8x	90	525	32.7	17.2	2826	2544	165
		785	33.3	26.1	4085	3676	156
		1050	33.9	35.6	5384	4845	151
		1170	34.1	39.9	5913	5322	148
		2100	36.0	75.5	10157	9142	134
		3000	37.5	112.6	14032	12629	125
BXRC-35G4000-D-8x	90	425	27.2	11.6	1902	1712	165
		650	27.7	18.0	2807	2527	156
		850	28.2	23.9	3624	3261	151
		1050	28.6	30.0	4380	3942	146
		1700	29.9	50.9	6837	6153	134
		2500	31.3	78.3	9693	8724	124

Notes for Table 3:

1. Alternate drive currents in Table 3 are provided for reference only and are not a guarantee of performance.
2. Bridgelux maintains a ± 7% tolerance on flux measurements.
3. Typical stabilized DC performance values are provided as reference only and are not a guarantee of performance.

Performance at Commonly Used Drive Currents

Table 3: Product Performance at Commonly Used Drive Currents (Continued)

Part Number	CRI	Drive Current ¹ (mA)	Typical V_f $T_c = 25^\circ\text{C}$ (V)	Typical Power $T_c = 25^\circ\text{C}$ (W)	Typical Flux ² $T_c = 25^\circ\text{C}$ (lm)	Typical DC Flux ³ $T_c = 85^\circ\text{C}$ (lm)	Typical Efficacy $T_c = 25^\circ\text{C}$ (lm/W)
BXRC-40C4001-B-8x	70	350	32.7	11.4	2419	2177	211
		525	33.3	17.5	3506	3155	201
		700	33.9	23.7	4607	4147	194
		900	34.5	31.0	5780	5202	186
		1400	36.0	50.4	8693	7824	173
		2000	37.5	75.1	12009	10808	160
BXRC-40C4001-C-8x	70	525	32.7	17.2	3617	3255	211
		785	33.3	26.1	5227	4704	200
		1050	33.9	35.6	6889	6200	194
		1170	34.1	39.9	7567	6810	190
		2100	36.0	75.5	12999	11699	172
		3000	37.5	112.6	17957	16162	159
BXRC-40C4001-D-8x	70	425	27.2	11.6	2434	2191	211
		650	27.7	18.0	3593	3233	199
		850	28.2	23.9	4637	4174	194
		1050	28.6	30.0	5606	5045	187
		1700	29.9	50.9	8750	7875	172
		2500	31.3	78.3	12404	11164	158
BXRC-40E4000-B-8x	80	350	32.7	11.4	2313	2082	202
		525	33.3	17.5	3353	3017	192
		700	33.9	23.7	4406	3965	186
		900	34.5	31.0	5527	4974	178
		1400	36.0	50.4	8313	7482	165
		2000	37.5	75.1	11484	10336	153
BXRC-40E4000-C-8x	80	525	32.7	17.2	3459	3113	202
		785	33.3	26.1	4999	4499	191
		1050	33.9	35.6	6588	5929	185
		1170	34.1	39.9	7236	6513	181
		2100	36.0	75.5	12430	11187	165
		3000	37.5	112.6	17172	15455	152
BXRC-40E4000-D-8x	80	425	27.2	11.6	2328	2095	202
		650	27.7	18.0	3436	3092	191
		850	28.2	23.9	4435	3991	185
		1050	28.6	30.0	5360	4824	179
		1700	29.9	50.9	8367	7530	165
		2500	31.3	78.3	11862	10676	151
BXRC-40G4000-B-8x	90	350	32.7	11.4	1930	1737	169
		525	33.3	17.5	2797	2517	160
		700	33.9	23.7	3676	3308	155
		900	34.5	31.0	4611	4150	149
		1400	36.0	50.4	6935	6242	138
		2000	37.5	75.1	9581	8623	128

Notes for Table 3:

1. Alternate drive currents in Table 3 are provided for reference only and are not a guarantee of performance.
2. Bridgelux maintains a $\pm 7\%$ tolerance on flux measurements.
3. Typical stabilized DC performance values are provided as reference only and are not a guarantee of performance.

Performance at Commonly Used Drive Currents

Table 3: Product Performance at Commonly Used Drive Currents (Continued)

Part Number	CRI	Drive Current ¹ (mA)	Typical V_f $T_c = 25^\circ\text{C}$ (V)	Typical Power $T_c = 25^\circ\text{C}$ (W)	Typical Flux ² $T_c = 25^\circ\text{C}$ (lm)	Typical DC Flux ³ $T_c = 85^\circ\text{C}$ (lm)	Typical Efficacy $T_c = 25^\circ\text{C}$ (lm/W)
BXRC-40G4000-C-8x	90	525	32.7	17.2	2885	2597	168
		785	33.3	26.1	4170	3753	160
		1050	33.9	35.6	5496	4947	155
		1170	34.1	39.9	6037	5433	151
		2100	36.0	75.5	10370	9333	137
		3000	37.5	112.6	14327	12894	127
BXRC-40G4000-D-8x	90	425	27.2	11.6	1942	1748	168
		650	27.7	18.0	2866	2580	159
		850	28.2	23.9	3700	3330	155
		1050	28.6	30.0	4472	4025	149
		1700	29.9	50.9	6981	6283	137
		2500	31.3	78.3	9896	8907	126
BXRC-50C4001-B-8x	70	350	32.7	11.4	2432	2189	213
		525	33.3	17.5	3525	3173	202
		700	33.9	23.7	4632	4169	195
		900	34.5	31.0	5811	5230	187
		1400	36.0	50.4	8740	7866	174
		2000	37.5	75.1	12075	10867	161
BXRC-50C4001-C-8x	70	525	32.7	17.2	3636	3273	212
		785	33.3	26.1	5256	4730	201
		1050	33.9	35.6	6927	6234	195
		1170	34.1	39.9	7609	6848	191
		2100	36.0	75.5	13070	11763	173
		3000	37.5	112.6	18055	16250	160
BXRC-50C4001-D-8x	70	425	27.2	11.6	2448	2203	212
		650	27.7	18.0	3612	3251	201
		850	28.2	23.9	4663	4196	195
		1050	28.6	30.0	5636	5073	188
		1700	29.9	50.9	8798	7918	173
		2500	31.3	78.3	12472	11225	159
BXRC-50E4001-B-8x	80	350	32.7	11.4	2339	2105	205
		525	33.3	17.5	3391	3052	194
		700	33.9	23.7	4456	4011	188
		900	34.5	31.0	5590	5031	180
		1400	36.0	50.4	8408	7567	167
		2000	37.5	75.1	11615	10454	155
BXRC-50E4001-C-8x	80	525	32.7	17.2	3498	3148	204
		785	33.3	26.1	5056	4550	194
		1050	33.9	35.6	6664	5997	187
		1170	34.1	39.9	7319	6587	183
		2100	36.0	75.5	12572	11315	166
		3000	37.5	112.6	17369	15632	154

Notes for Table 3:

1. Alternate drive currents in Table 3 are provided for reference only and are not a guarantee of performance.
2. Bridgelux maintains a $\pm 7\%$ tolerance on flux measurements.
3. Typical stabilized DC performance values are provided as reference only and are not a guarantee of performance.

Performance at Commonly Used Drive Currents

Table 3: Product Performance at Commonly Used Drive Currents (Continued)

Part Number	CRI	Drive Current ¹ (mA)	Typical V _f T _c = 25°C (V)	Typical Power T _c = 25°C (W)	Typical Flux ² T _c = 25°C (lm)	Typical DC Flux ³ T _c = 85°C (lm)	Typical Efficacy T _c = 25°C (lm/W)
BXRC-50E4001-D-8x	80	425	27.2	11.6	2355	2119	204
		650	27.7	18.0	3475	3127	193
		850	28.2	23.9	4485	4037	187
		1050	28.6	30.0	5422	4880	181
		1700	29.9	50.9	8463	7617	166
		2500	31.3	78.3	11997	10798	153
BXRC-50G4001-B-8x	90	350	32.7	11.4	2022	1820	177
		525	33.3	17.5	2931	2638	168
		700	33.9	23.7	3852	3467	163
		900	34.5	31.0	4832	4349	156
		1400	36.0	50.4	7268	6541	144
		2000	37.5	75.1	10040	9036	134
BXRC-50G4001-C-8x	90	525	32.7	17.2	3024	2721	176
		785	33.3	26.1	4370	3933	167
		1050	33.9	35.6	5760	5184	162
		1170	34.1	39.9	6327	5694	159
		2100	36.0	75.5	10868	9781	144
		3000	37.5	112.6	15013	13512	133
BXRC-50G4001-D-8x	90	425	27.2	11.6	2035	1832	176
		650	27.7	18.0	3004	2703	167
		850	28.2	23.9	3877	3489	162
		1050	28.6	30.0	4687	4218	156
		1700	29.9	50.9	7315	6584	144
		2500	31.3	78.3	10371	9334	132
BXRC-57C4001-B-8x	70	350	32.7	11.4	2366	2129	207
		525	33.3	17.5	3429	3086	196
		700	33.9	23.7	4507	4056	190
		900	34.5	31.0	5654	5088	182
		1400	36.0	50.4	8503	7653	169
		2000	37.5	75.1	11746	10572	156
BXRC-57C4001-C-8x	70	525	32.7	17.2	3538	3184	206
		785	33.3	26.1	5113	4602	196
		1050	33.9	35.6	6739	6065	190
		1170	34.1	39.9	7402	6662	185
		2100	36.0	75.5	12714	11443	168
		3000	37.5	112.6	17565	15808	156
BXRC-57C4001-D-8x	70	425	27.2	11.6	2381	2143	206
		650	27.7	18.0	3514	3163	195
		850	28.2	23.9	4536	4082	190
		1050	28.6	30.0	5483	4935	183
		1700	29.9	50.9	8558	7703	168
		2500	31.3	78.3	12133	10920	155

Notes for Table 3:

1. Alternate drive currents in Table 3 are provided for reference only and are not a guarantee of performance.
2. Bridgelux maintains a ± 7% tolerance on flux measurements.
3. Typical stabilized DC performance values are provided as reference only and are not a guarantee of performance.

Performance at Commonly Used Drive Currents

Table 3: Product Performance at Commonly Used Drive Currents (Continued)

Part Number	CRI	Drive Current ¹ (mA)	Typical V _f T _c = 25°C (V)	Typical Power T _c = 25°C (W)	Typical Flux ² T _c = 25°C (lm)	Typical DC Flux ³ T _c = 85°C (lm)	Typical Efficacy T _c = 25°C (lm/W)
BXRC-57E4001-B-8x	80	350	32.7	11.4	2247	2022	196
		525	33.3	17.5	3257	2931	186
		700	33.9	23.7	4280	3852	181
		900	34.5	31.0	5369	4832	173
		1400	36.0	50.4	8075	7268	160
		2000	37.5	75.1	11156	10040	149
BXRC-57E4001-C-8x	80	525	32.7	17.2	3360	3024	196
		785	33.3	26.1	4856	4370	186
		1050	33.9	35.6	6400	5760	180
		1170	34.1	39.9	7030	6327	176
		2100	36.0	75.5	12075	10868	160
		3000	37.5	112.6	16682	15013	148
BXRC-57E4001-D-8x	80	425	27.2	11.6	2262	2035	196
		650	27.7	18.0	3338	3004	185
		850	28.2	23.9	4308	3877	180
		1050	28.6	30.0	5207	4687	173
		1700	29.9	50.9	8128	7315	160
		2500	31.3	78.3	11523	10371	147
BXRC-65C4001-B-8x	70	350	32.7	11.4	2366	2129	207
		525	33.3	17.5	3429	3086	196
		700	33.9	23.7	4507	4056	190
		900	34.5	31.0	5654	5088	182
		1400	36.0	50.4	8503	7653	169
		2000	37.5	75.1	11746	10572	156
BXRC-65C4001-C-8x	70	525	32.7	17.2	3538	3184	206
		785	33.3	26.1	5113	4602	196
		1050	33.9	35.6	6739	6065	190
		1170	34.1	39.9	7402	6662	185
		2100	36.0	75.5	12714	11443	168
		3000	37.5	112.6	17565	15808	156
BXRC-65C4001-D-8x	70	425	27.2	11.6	2381	2143	206
		650	27.7	18.0	3514	3163	195
		850	28.2	23.9	4536	4082	190
		1050	28.6	30.0	5483	4935	183
		1700	29.9	50.9	8558	7703	168
		2500	31.3	78.3	12133	10920	155
BXRC-65E4001-B-8x	80	350	32.7	11.4	2273	2046	199
		525	33.3	17.5	3295	2966	189
		700	33.9	23.7	4330	3897	183
		900	34.5	31.0	5432	4889	175
		1400	36.0	50.4	8170	7353	162
		2000	37.5	75.1	11287	10158	150

Notes for Table 3:

1. Alternate drive currents in Table 3 are provided for reference only and are not a guarantee of performance.
2. Bridgelux maintains a ± 7% tolerance on flux measurements.
3. Typical stabilized DC performance values are provided as reference only and are not a guarantee of performance.

Performance at Commonly Used Drive Currents

Table 3: Product Performance at Commonly Used Drive Currents (Continued)

Part Number	CRI	Drive Current ¹ (mA)	Typical V_f $T_c = 25^\circ\text{C}$ (V)	Typical Power $T_c = 25^\circ\text{C}$ (W)	Typical Flux ² $T_c = 25^\circ\text{C}$ (lm)	Typical DC Flux ³ $T_c = 85^\circ\text{C}$ (lm)	Typical Efficacy $T_c = 25^\circ\text{C}$ (lm/W)
BXRC-65E4001-C-8x	80	525	32.7	17.2	3399	3059	198
		785	33.3	26.1	4913	4422	188
		1050	33.9	35.6	6475	5828	182
		1170	34.1	39.9	7112	6401	178
		2100	36.0	75.5	12217	10996	162
		3000	37.5	112.6	16878	15190	150
BXRC-65E4001-D-8x	80	425	27.2	11.6	2288	2059	198
		650	27.7	18.0	3377	3039	187
		850	28.2	23.9	4359	3923	182
		1050	28.6	30.0	5269	4742	175
		1700	29.9	50.9	8224	7401	162
		2500	31.3	78.3	11659	10493	149

Notes for Table 3:

1. Alternate drive currents in Table 3 are provided for reference only and are not a guarantee of performance.
2. Bridgelux maintains a $\pm 7\%$ tolerance on flux measurements.
3. Typical stabilized DC performance values are provided as reference only and are not a guarantee of performance.

Electrical Characteristics

Table 4: Electrical Characteristics

Part Number	Drive Current (mA)	Forward Voltage Pulsed, $T_c = 25^\circ\text{C}$ (V) ^{1, 2, 3, 8}			Typical Coefficient of Forward Voltage ⁴ $\Delta V_f / \Delta T_c$ (mV/ $^\circ\text{C}$)	Typical Thermal Resistance Junction to Case ^{5,6} R_{j-c} ($^\circ\text{C}/\text{W}$)	Driver Selection Voltages ⁷ (V)	
		Minimum	Typical	Maximum			V_f Min. Hot $T_c = 105^\circ\text{C}$ (V)	V_f Max. Cold $T_c = -40^\circ\text{C}$ (V)
BXRC-xxx400x-B-8x	700	31.4	33.9	36.4	-10.93	0.14	30.5	37.2
	2000	34.7	37.5	40.3	-12.10	0.23	33.7	41.1
BXRC-xxx400x-C-8x	1050	31.4	33.9	36.4	-10.93	0.12	30.5	37.2
	3000	34.7	37.5	40.3	-12.10	0.20	33.7	41.1
BXRC-xxx400x-D-8x	850	26.1	28.2	30.3	-9.10	0.13	25.4	30.9
	2500	29.0	31.3	33.6	-10.10	0.22	28.1	34.3

Notes for Table 4:

- Parts are tested in pulsed conditions, $T_c = 25^\circ\text{C}$. Pulse width is 10ms.
- Voltage minimum and maximum are provided for reference only and are not a guarantee of performance.
- Bridgelux maintains a tester tolerance of $\pm 0.10\text{V}$ on forward voltage measurements.
- Typical coefficient of forward voltage tolerance is $\pm 0.1\text{mV}$ for nominal current.
- Thermal resistance values are based from test data of a 3000K 80 CRI product.
- Thermal resistance value was calculated using total electrical input power; optical power was not subtracted from input power. The thermal interface material used during testing is not included in the thermal resistance value.
- V_f min hot and max cold values are provided as reference only and are not guaranteed by test. These values are provided to aid in driver design and selection over the operating range of the product.
- This product has been designed and manufactured per IEC 62031:2014. This product has passed dielectric withstand voltage testing at 1140 V. The working voltage designated for the insulation is 70V d.c. The maximum allowable voltage across the array must be determined in the end product application.

Eye Safety

Table 5: Eye Safety Risk Group (RG) Classifications

Part Number	Drive Current (mA)	CCT			
		2700K/3000K	4000K ²	5000K ³	6500K ⁴
BXRC-xxx400x-B-8x	1440	RG1	RG1	RG1	RG1
	2000	RG1	RG1	RG1	RG2
BXRC-xxx400x-C-8x	1440	RG1	RG1	RG1	RG1
	1995	RG1	RG1	RG1	RG2
	2650	RG1	RG1	RG2	RG2
	3000	RG1	RG2	RG2	RG2
BXRC-xxx400x-D-8x	1730	RG1	RG1	RG1	RG1
	2400	RG1	RG1	RG1	RG2
	2500	RG1	RG1	RG2	RG2

Notes for Table 5:

1. Eye safety classification for the use of Bridgelux V Series LED arrays is in accordance with specification IEC/TR 62778: Application of IEC 62471 for the assessment of blue light hazard to light sources and luminaires.
2. For products classified as RG2 at 4000K, Ethr= 1980 lx.
3. For products classified as RG2 at 5000K Ethr= 1530 lx.
4. For products classified as RG2 at 6500K, Ethr= 1170 lx.
5. Please contact your Bridgelux sales representative for Ethr values at specific drive currents and CCTs not listed.

Absolute Maximum Ratings

Table 6: Maximum Ratings

Parameter	Maximum Rating		
LED Junction Temperature (T_j)	150°C		
Storage Temperature	-40°C to +105°C		
Operating Case Temperature ¹ (T_c)	105°C		
Soldering Temperature ²	300°C or lower for a maximum of 6 seconds		
	BXRC-xxx400x-B-8x	BXRC-xxx400x-C-8x	BXRC-xxx400x-D-8x
Maximum Drive Current ³	2000 mA	3000 mA	2500 mA
Maximum Peak Pulsed Drive Current ⁴	2240 mA	3360 mA	2800 mA
Maximum Reverse Voltage ⁵	-60V	-60V	-50V

Notes for Table 6:

1. For IEC 62717 requirement, please consult your Bridgelux sales representative.
2. Refer to Bridgelux Application Note AN31: Assembly Considerations for Bridgelux Vero LED Arrays.
3. Arrays may be driven at higher currents however lumen maintenance may be reduced and warranty will not apply.
4. Bridgelux recommends a maximum duty cycle of 10% and pulse width of 20 ms when operating LED Arrays at maximum peak pulsed current specified. Maximum peak pulsed currents indicate values where LED Arrays can be driven without catastrophic failures.
5. Light emitting diodes are not designed to be driven in reverse voltage and will not produce light under this condition. Maximum rating provided for reference only.

Performance Curves

Figure 1: Vero 18B Drive Current vs. Voltage

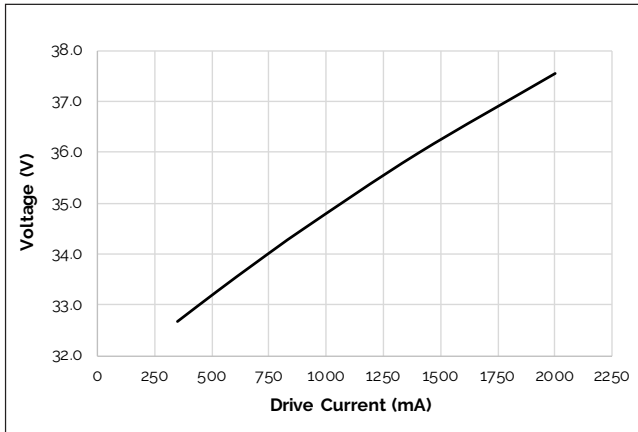

Figure 2: Vero 18C Drive Current vs. Voltage

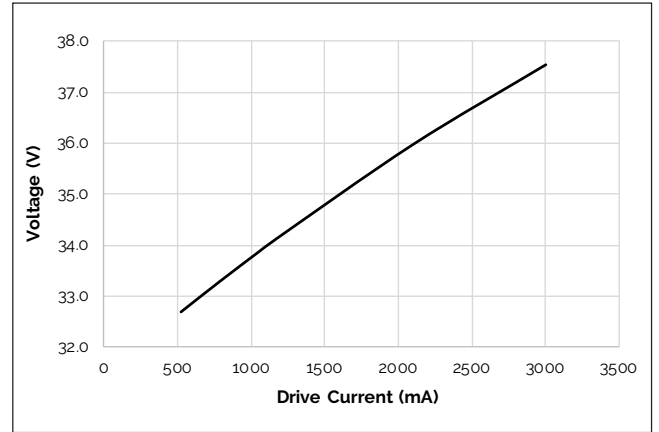

Figure 3: Vero 18D Drive Current vs. Voltage

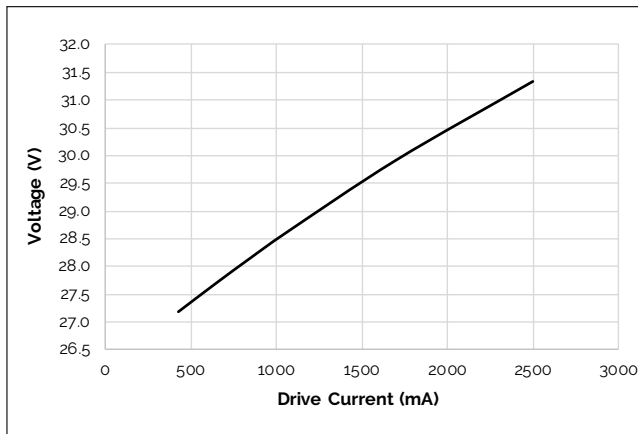

Figure 4: Vero 18B Typical Relative Flux vs. Current

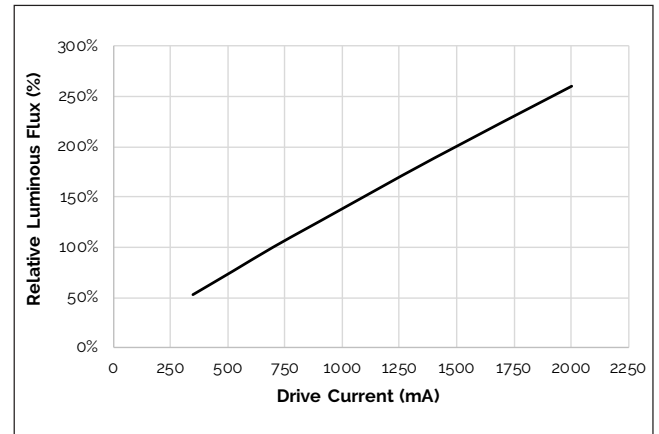

Figure 5: Vero 18C Typical Relative Flux vs. Current

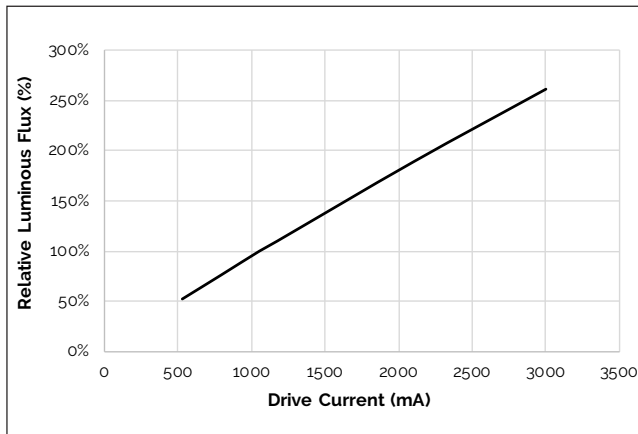
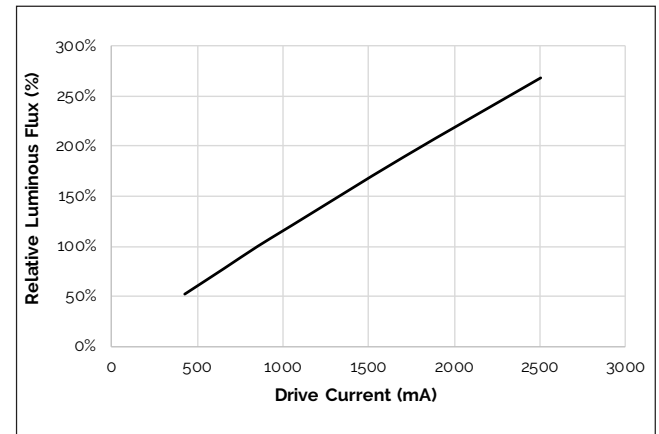

Figure 6: Vero 18D Typical Relative Flux vs. Current



Notes for Figures 1-6:

1. Bridgelux does not recommend driving high power LEDs at low currents. Doing so may produce unpredictable results. Pulse width modulation (PWM) is recommended for dimming effects.
2. Products tested under pulsed condition (10ms pulse width) at nominal test current where T_j (junction temperature) = T_c (case temperature) = 25°C.

Performance Curves

Figure 7: Typical DC Flux vs. Case Temperature

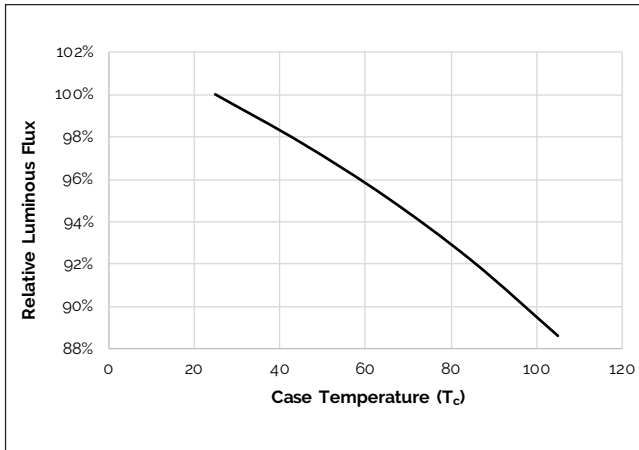

Figure 8: Typical DC ccy Shift vs. Case Temperature

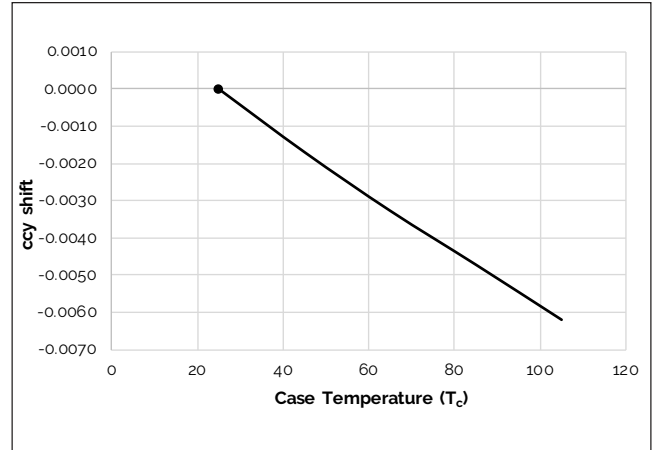

Figure 9: Typical DC ccx Shift vs. Case Temperature

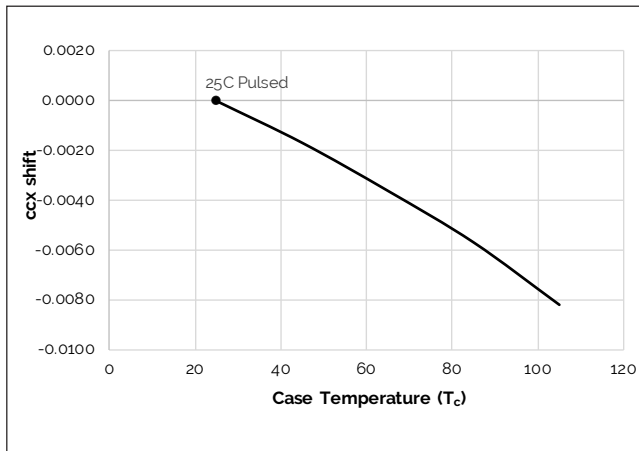
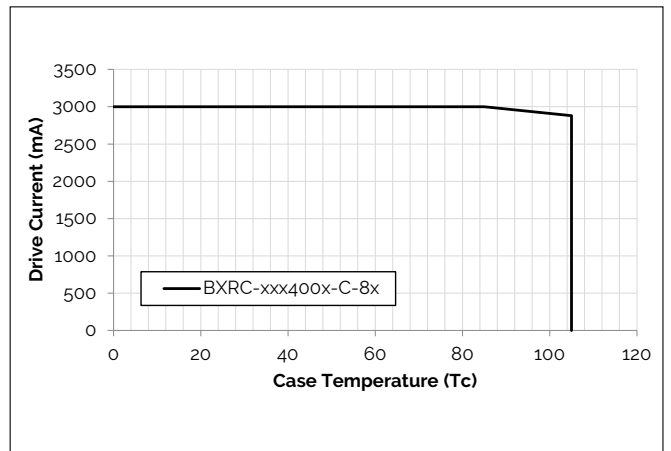
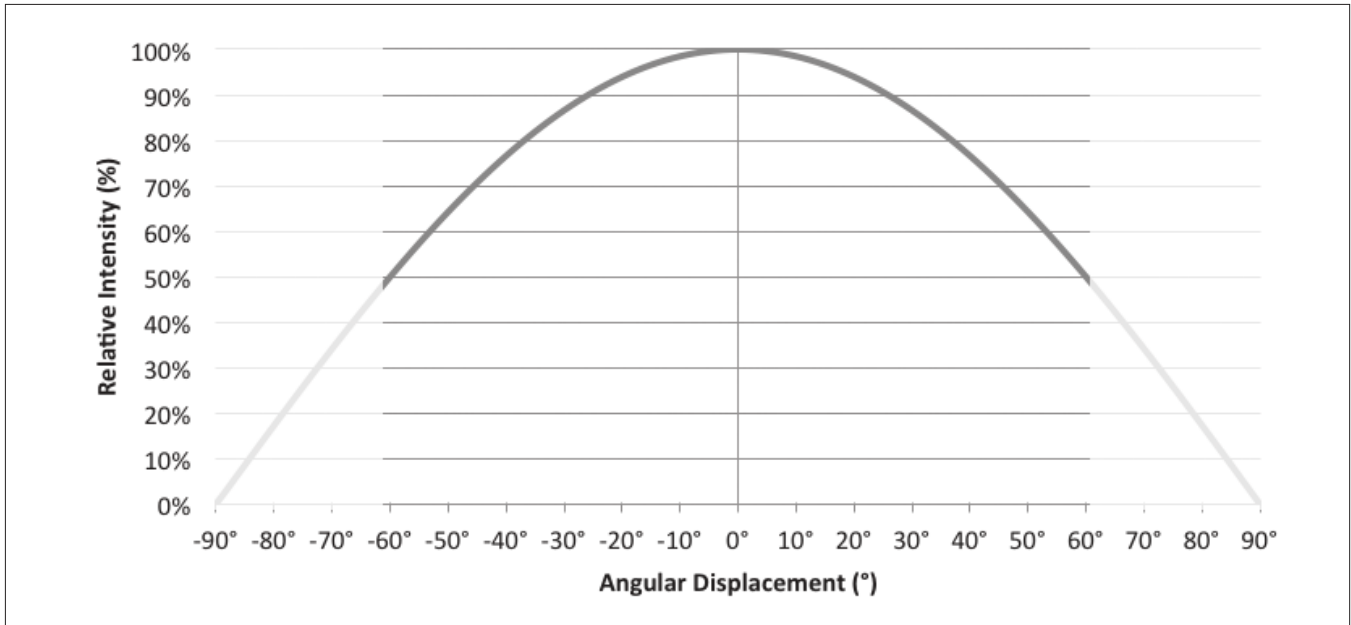

Figure 10: Derating Curve



Typical Radiation Pattern

Figure 11: Typical Spatial Radiation Pattern



Note for Figure 11:

1. Typical viewing angle is 120°.
2. The viewing angle is defined as the off axis angle from the centerline where intensity is ½ of the peak value.

Figure 12: Typical Polar Radiation Pattern

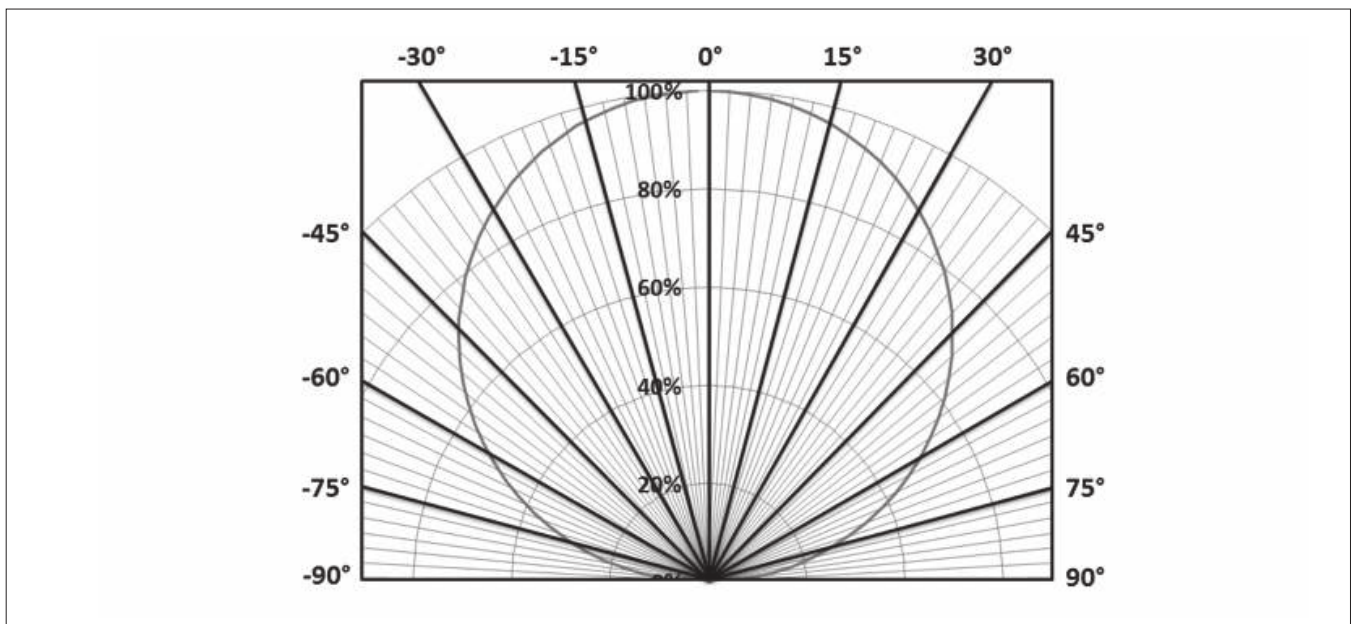

Typical Color Spectrum

Figure 13: Typical Color Spectrum

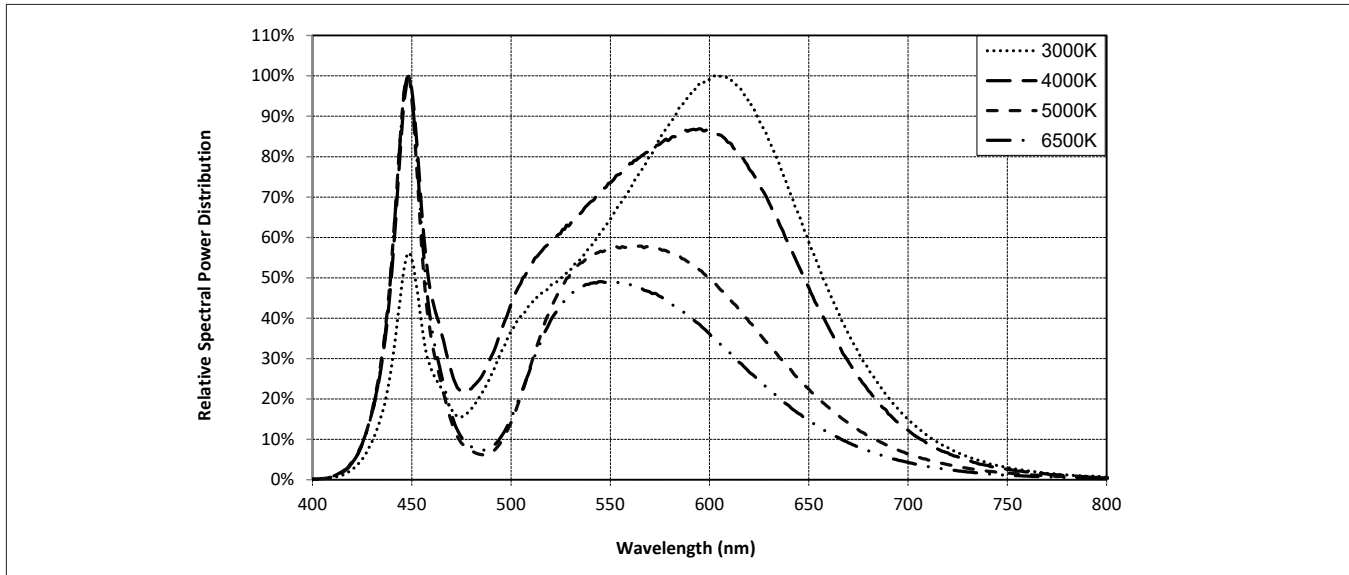

Note for Figure 13:

1. Color spectra measured at nominal current for $T_j = T_c = 25^\circ\text{C}$.
2. Color spectra shown is 3000K and 80 CRI.
3. Color spectra shown is 4000K and 80 CRI.
4. Color spectra shown is 5000K and 70 CRI.
4. Color spectra shown is 6500K and 70 CRI.

Mechanical Dimensions

Figure 14: Drawing for Vero 18 LED Array

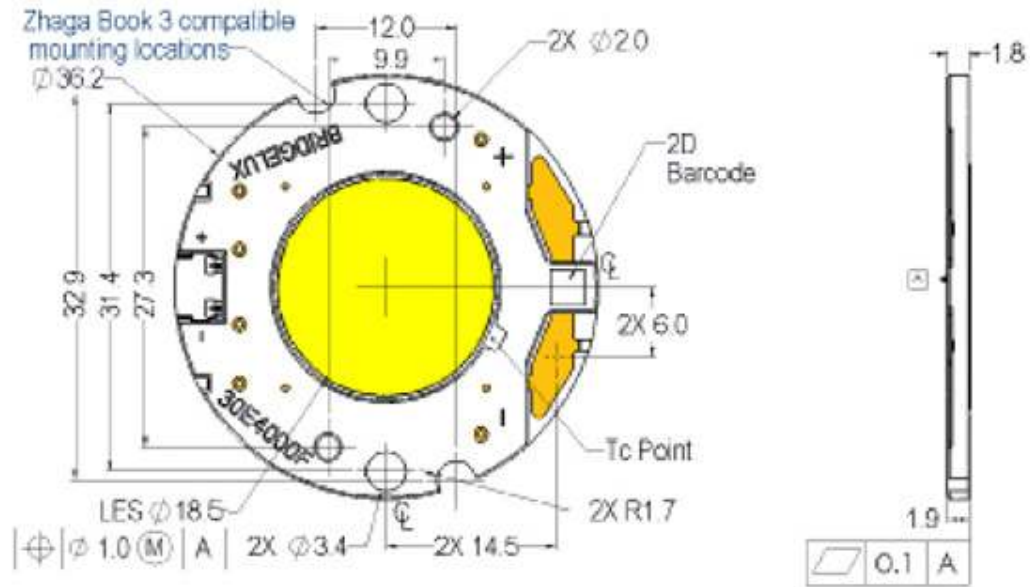

Notes for Figure 14:

1. Drawings are not to scale.
2. Drawing dimensions are in millimeters.
3. Unless otherwise specified, tolerances are $\pm 0.1\text{mm}$.
4. Mounting holes (2X) are for M2.5 screws.
5. Bridgelux recommends two tapped holes for mounting screws with $31.4 \pm 0.10\text{mm}$ center-to-center spacing.
6. Screws with flat shoulders (pan, dome, button, round, truss, mushroom) provide optimal torque control. Do NOT use flat, countersink, or raised head screws.
7. Solder pads and connector port are labeled "+" and "-" to denote positive and negative, respectively.
8. It is not necessary to provide electrical connections to both the solder pads and the connector port. Either set may be used depending on application specific design requirements.
9. Refer to Application Notes AN30 and AN31 for product handling, mounting and heat sink recommendations.
10. The optical center of the LED Array is nominally defined by the mechanical center of the array to a tolerance of $\pm 0.2\text{mm}$.
11. Bridgelux maintains a flatness of 0.10mm across the mounting surface of the array.

Color Binning Information

Figure 15: Warm and Neutral White Test Bins in xy Color Space

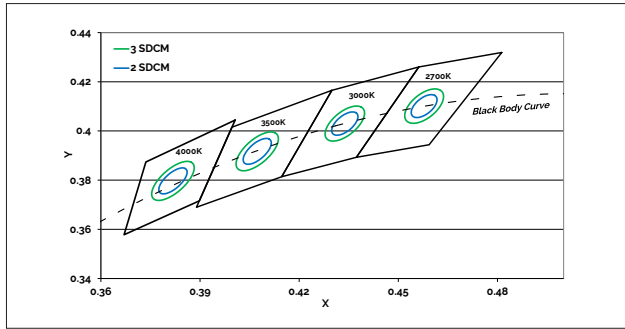

Note: Pulsed Test Conditions, $T_c = 25^\circ\text{C}$

Table 7: Warm and Neutral White xy Bin Coordinates and Associated Typical CCT

Bin Code	2700K	3000K	3500K	4000K
ANSI Bin (for reference only)	(2580K - 2870K)	(2870K - 3220K)	(3220K - 3710K)	(3710K - 4260K)
83 (3 SDCM)	(2651K - 2794K)	(2968K - 3136K)	(3369K - 3586K)	(3851K - 4130K)
82 (2 SDCM)	(2674K - 2769K)	(2995K - 3107K)	(3404K - 3548K)	(3895K - 4081K)
Center Point (x,y)	(0.4578, 0.4101)	(0.4338, 0.403)	(0.4073, 0.3917)	(0.3818, 0.3797)

Figure 16: Cool White Test Bins in xy Color Space

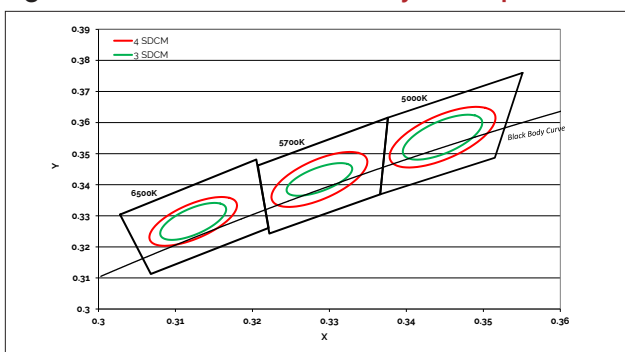

Note: Pulsed Test Conditions, $T_c = 25^\circ\text{C}$

Table 8: Cool White xy Bin Coordinates and Associated Typical CCT (product is hot targeted to $T_c = 85^\circ\text{C}$)

Bin Code	5000K	5700K	6500K
ANSI Bin (for reference only)	(4745K - 5311K)	(5312K - 6022K)	(6022K - 7042K)
84 (4 SDCM)	(4801K - 5282K)	(5481K - 5829K)	(6270K - 6765K)
83 (3 SDCM)	(4835K - 5215K)	(5490K - 5820K)	(6250K - 6745K)
Center Point (x,y)	(0.3447, 0.3553)	(0.3287, 0.3417)	(0.3123, 0.3282)

Packaging and Labeling

Figure 17: Drawing for Vero 18 Packaging Tray

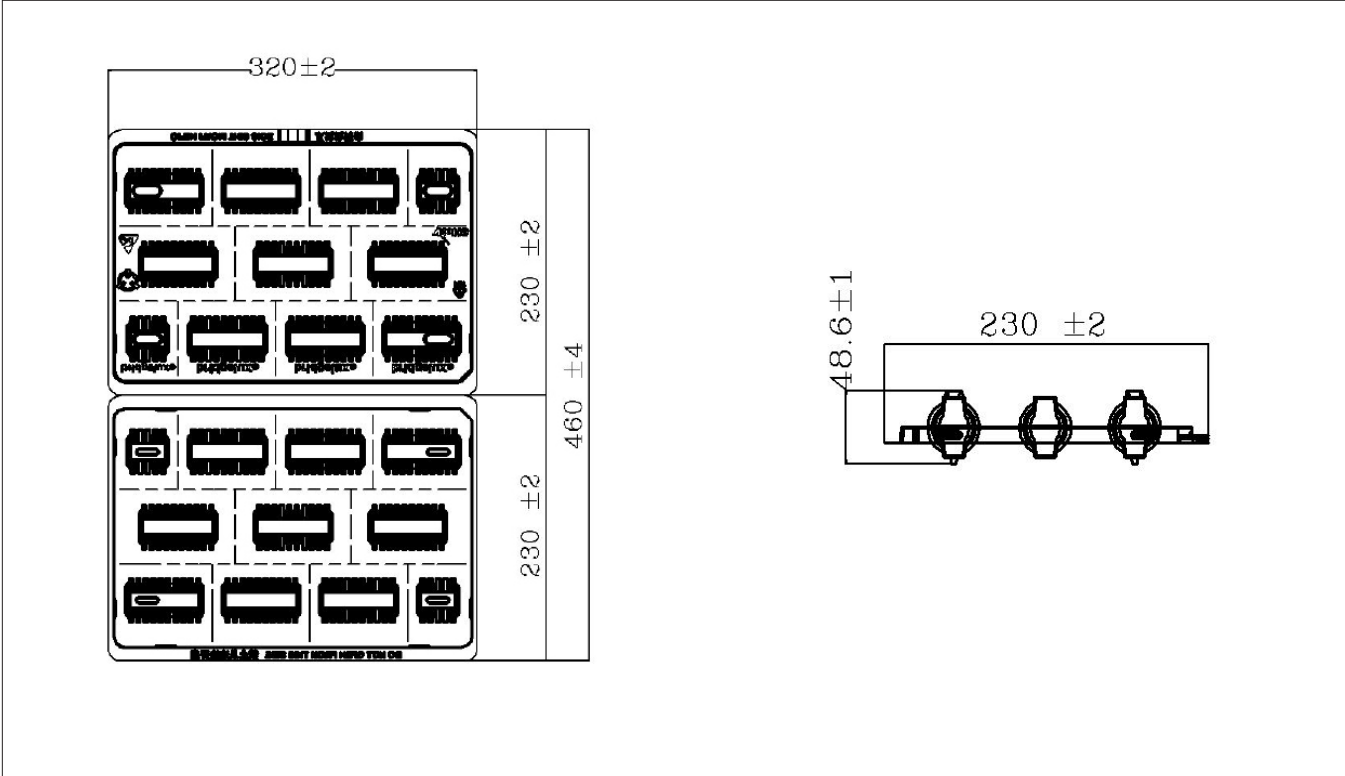

- Notes for Figure 17:
1. Dimensions are in millimeters.
 2. Drawings are not to scale.

Packaging and Labeling

Figure 18: Vero Series Packaging and Labeling



Notes for Figure 18:

1. Each tray holds 100 COBs.
2. Each tray is vacuum sealed in an anti-static bag and placed in its own box.
3. Each tray, bag and box is to be labeled as shown above.

Figure 19: Gen. 8 Product Labeling

Bridgelux COB arrays have laser markings on the back side of the substrate to help with product identification. In addition to the product identification markings, Bridgelux COB arrays also contain markings for internal Bridgelux manufacturing use only. The image below shows which markings are for customer use and which ones are for Bridgelux internal use only. The Bridgelux internal manufacturing markings are subject to change without notice, however these will not impact the form, function or performance of the COB array.



Customer Use- 2D Barcode
Scannable barcode provides product part number and other Bridgelux internal production information.

Customer Use- Product part number

30E4000C 83 2F

Customer Use- V_f Bin Code
included to enable greater luminaire design flexibility. Refer to ANG2 for bin code definitions.

Design Resources

Application Notes

Bridgelux has developed a comprehensive set of application notes and design resources to assist customers in successfully designing with the Vero product family of LED array products. For all available application notes visit www.bridgelux.com.

Optical Source Models

Optical source models and ray set files are available for all Bridgelux products. For a list of available formats, visit www.bridgelux.com.

3D CAD Models

Three dimensional CAD models depicting the product outline of all Bridgelux Vero LED arrays are available in both IGS and STEP formats. Please contact your Bridgelux sales representative for assistance.

LM80

LM80 testing has been completed and the LM80 report is now available. Please contact your Bridgelux sales representative for LM-80 report.

Precautions

CAUTION: CHEMICAL EXPOSURE HAZARD

Exposure to some chemicals commonly used in luminaire manufacturing and assembly can cause damage to the LED array. Please consult Bridgelux Application Note AN31 for additional information.

CAUTION: RISK OF BURN

Do not touch the Vero LED array during operation. Allow the array to cool for a sufficient period of time before handling. The Vero LED array may reach elevated temperatures such that could burn skin when touched.

CAUTION

CONTACT WITH LIGHT EMITTING SURFACE (LES)

Avoid any contact with the LES. Do not touch the LES of the LED array or apply stress to the LES (yellow phosphor resin area). Contact may cause damage to the LED array.

Optics and reflectors must not be mounted in contact with the LES (yellow phosphor resin area). Optical devices may be mounted on the top surface of the plastic housing of the Vero LED array. Use the mechanical features of the LED array housing, edges and/or mounting holes to locate and secure optical devices as needed.

Disclaimers

MINOR PRODUCT CHANGE POLICY

The rigorous qualification testing on products offered by Bridgelux provides performance assurance. Slight cosmetic changes that do not affect form, fit, or function may occur as Bridgelux continues product optimization.

STANDARD TEST CONDITIONS

Unless otherwise stated, array testing is performed at the nominal drive current.

About Bridgelux: Bridging Light and Life™

At Bridgelux, we help companies, industries and people experience the power and possibility of light. Since 2002, we've designed LED solutions that are high performing, energy efficient, cost effective and easy to integrate. Our focus is on light's impact on human behavior, delivering products that create better environments, experiences and returns—both experiential and financial. And our patented technology drives new platforms for commercial and industrial luminaires.

For more information about the company, please visit
bridgelux.com
twitter.com/Bridgelux
facebook.com/Bridgelux
youtube.com/user/Bridgelux
linkedin.com/company/bridgelux-inc-_2
WeChat ID: BridgeluxInChina



46430 Fremont Boulevard
Fremont, CA 94538 U.S.A.
Tel (925) 583-8400
www.bridgelux.com

© 2020 Bridgelux, Inc. All rights reserved. Product specifications are subject to change without notice. Bridgelux, the Bridgelux stylized logo design, Vero, V Series and V Series HD are registered trademarks, and Decor Series is a trademark of Bridgelux, Inc. All other trademarks are the property of their respective owners.

Bridgelux Gen 8 Vero 18 Array Series Product Data Sheet DS422 Rev. A (07/2020)