

## Features

- Attenuation: 1.0 dB Steps to 31 dB
- Low DC Power Consumption
- Plastic SOW, Wide Body, SMT Package
- Integral TTL Driver
- 50  $\Omega$  Impedance
- Test Boards are Available
- Tape and Reel Packaging Available
- Lead-Free SOW-16 Package
- Halogen-Free “Green” Mold Compound
- 260°C Reflow Compatible
- RoHS\* Compliant Version of AT65-0263

## Description

The MAATCC0007 is a GaAs FET 5-bit digital attenuator with integral TTL driver. Step size is 1.0 dB providing 31 dB total attenuation range. This device is in a SOW-16 plastic surface mount package.

The MAATCC0007 is ideally suited for use where accuracy, fast speed, very low power consumption and low costs are required.

## Ordering Information<sup>1</sup>

Part Number	Package
MAATCC0007	Bulk Packaging
MAATCC0007TR	1000 piece reel
MAATCC0007-TB	Sample Test Board

1. Reference Application Note M513 for reel size information.

## Schematic with Off-Chip Components

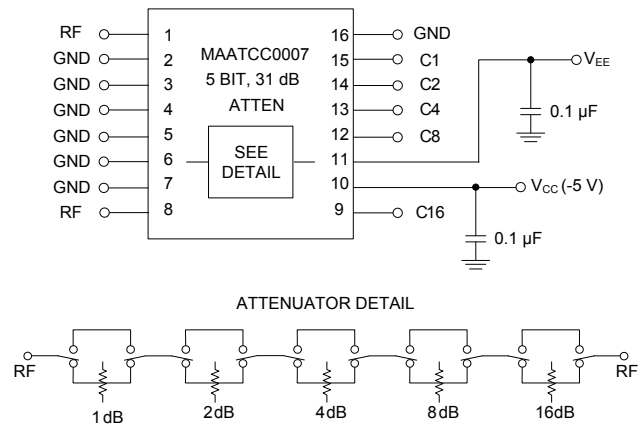

## Pin Configuration

Pin No.	Function	Pin No.	Function
1	RF	9	C16
2	GND	10	Vcc
3	GND	11	Vee
4	GND	12	C8
5	GND	13	C4
6	GND	14	C2
7	GND	15	C1
8	RF	16	GND

\* Restrictions on Hazardous Substances, European Union Directive 2011/65/EU.

**Electrical Specifications: Freq. = DC - 2 GHz, T<sub>A</sub> = 25°C**

Parameter	Test Conditions	Units	Min.	Typ.	Max.
Insertion Loss	—	dB	—	2.8	3.2
Attenuation Accuracy	Individual Bits 1, 2, 4, 8, 16 Any Combination of bits 3 - 29 dB Any Combination of bits 30 - 31 dB	dB	±(0.5 +5% of atten setting) ±(0.5 +5% of atten setting) ±(0.7 +7% of atten setting)		
VSWR	Full Range	Ratio	—	1.5:1	1.8:1
Switching Speed	50% Control to 90%/10% RF 10% to 90% or 90% to 10%	ns	—	75 20	150 50
1 dB Compression	50 MHz 0.5-2.0 GHz	dBm	—	+21 +24	—
Input IP3	Two-tone inputs up to +5 dBm 50 MHz 0.5-2.0 GHz	dB	—	+35 +48	—
$V_{CC}^2$ $V_{EE}^2$	—	V	4.75 -8.0	5.0 -5.0	5.25 -4.75
$V_{IL}$ $V_{IH}$	LOW-level input voltage HIGH-level input voltage	V	0.0 2.0	—	0.8 5.0
Input Leakage Current	$V_{IN} = V_{CC}$ or GND	μA	-1.0	—	1.0
$I_{CC}$ (Quiescent Supply Current)	$V_{CTRL} = V_{CC}$ or GND	μA	—	250	400
$\Delta I_{CC}^3$ (Additional Supply Current Per TTL Input Pin)	$V_{CC} = \text{max}$ , $V_{CTRL} = V_{CC} - 2.1$ V	mA	—	—	1.0
$I_{EE}$	$V_{EE}$ min to max, $V_{IN} = V_{IL}$ or $V_{IH}$	mA	-1.0	-0.2	—
Thermal Resistance $\theta_{JA}$	PCB mount on FR4 material, copper trace, still air at +25°C	°C/W	—	90 - 130	—

- Decoupling capacitors (0.1 μF) are required on power supply lines.
- For calculating  $\Delta I_{CC}$ , the number of TTL input pins is 6.

## Absolute Maximum Ratings<sup>4,5</sup>

Parameter	Absolute Maximum
Input Power 0.05 GHz 0.5 - 2.0 GHz	+27 dBm +34 dBm
V <sub>CC</sub>	-0.5 V ≤ V <sub>CC</sub> ≤ +7.0 V
V <sub>EE</sub>	-8.5 V ≤ V <sub>EE</sub> ≤ +0.5 V
V <sub>CC</sub> - V <sub>EE</sub>	-0.5 V ≤ V <sub>CC</sub> - V <sub>EE</sub> ≤ 14.5 V
V <sub>IN</sub>	-0.5 V ≤ V <sub>IN</sub> ≤ V <sub>CC</sub> + 0.5 V
Operating Temperature	-40°C to +85°C
Storage Temperature	-65°C to +125°C

4. Exceeding any one or combination of these limits may cause permanent damage to this device.
5. MACOM does not recommend sustained operation near these survivability limits.

## Truth Table (Digital Attenuator)

C16	C8	C4	C2	C1	Attenuation
0	0	0	0	0	Loss, Reference
0	0	0	0	1	1 dB
0	0	0	1	0	2 dB
0	0	1	0	0	4 dB
0	1	0	0	0	8 dB
1	0	0	0	0	16 dB
1	1	1	1	1	31 dB

0 = TTL Low; 1 = TTL High

## Handling Procedures

Please observe the following precautions to avoid damage:

## Static Sensitivity

Gallium Arsenide Integrated Circuits are sensitive to electrostatic discharge (ESD) and can be damaged by static electricity. Proper ESD control techniques should be used when handling these devices.

## Typical Performance Curves

Insertion Loss

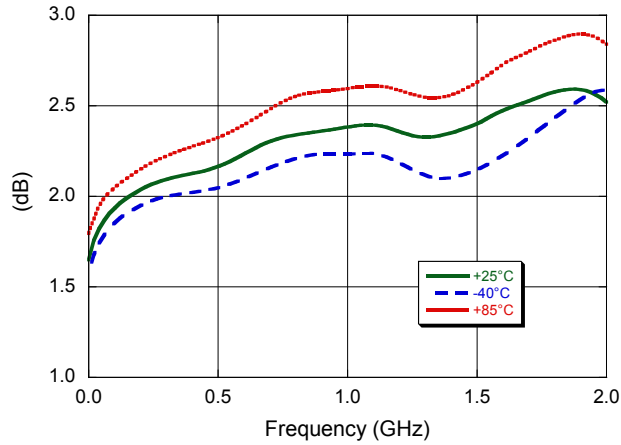

Attenuation @ 1 dB

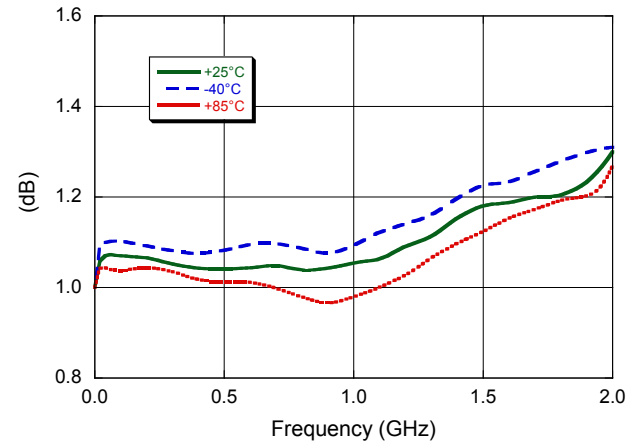

Attenuation @ 2 dB

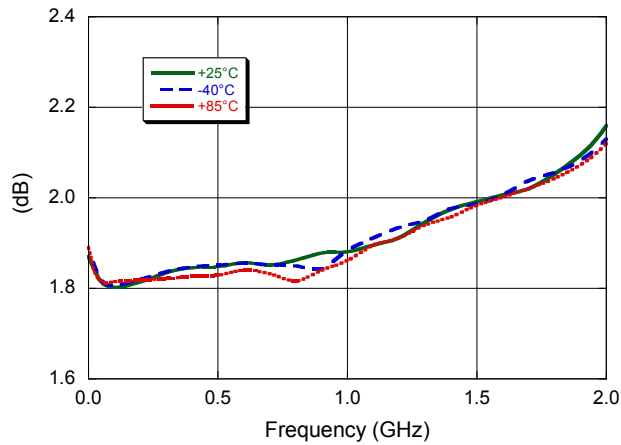

Attenuation @ 4 dB

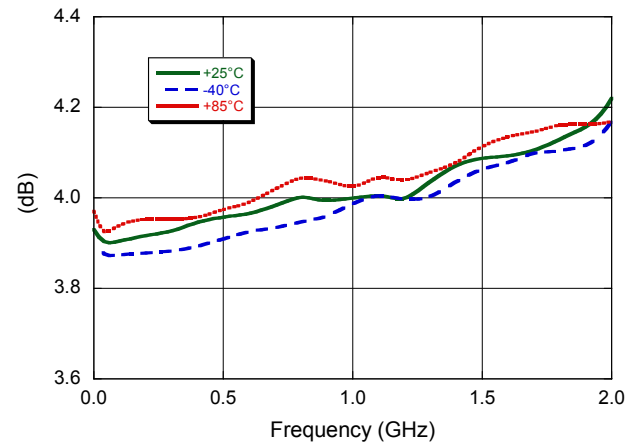

Attenuation @ 8 dB

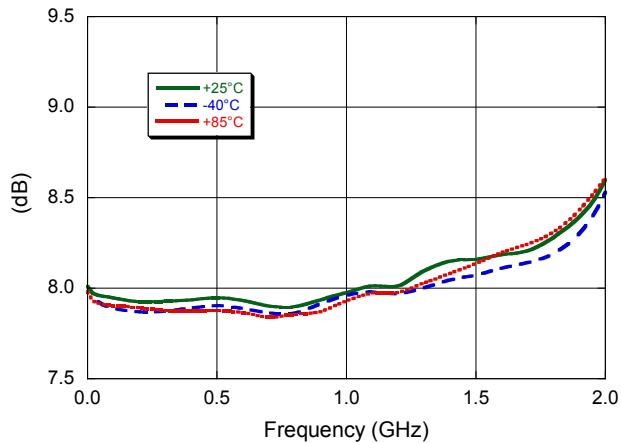

Attenuation @ 16 dB

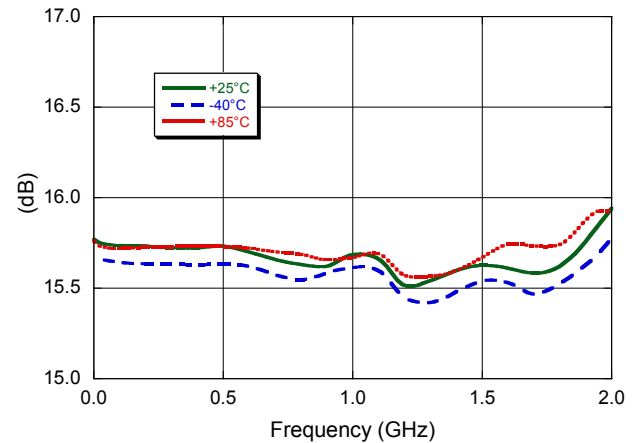

## Typical Performance Curves

**Attenuation @ 31 dB**

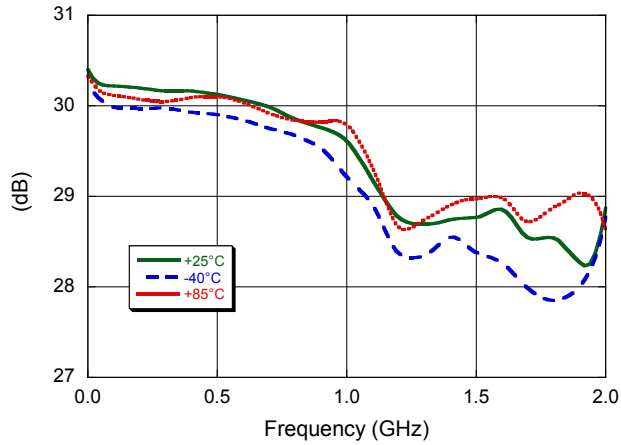

**Maximum VSWR, Loss**

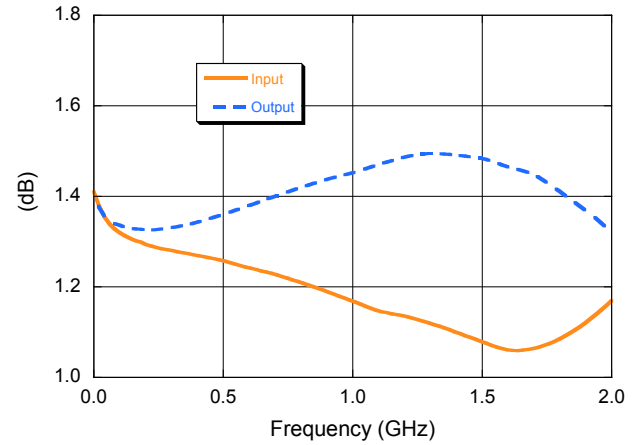

**Maximum VSWR, 1 dB Bit**

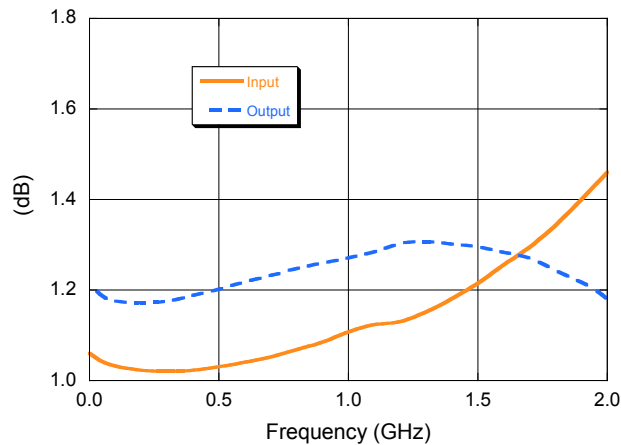

**Maximum VSWR, 2 dB Bit**

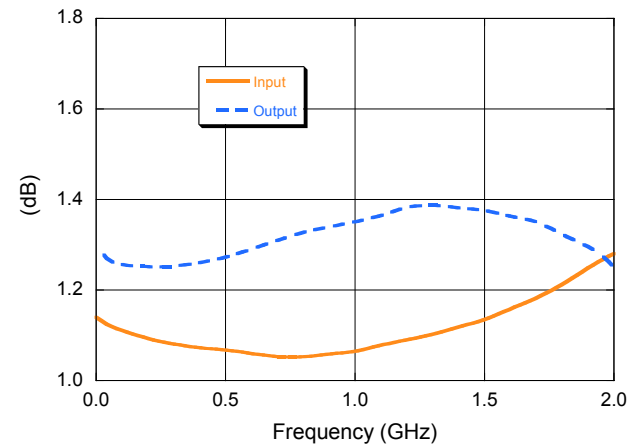

**Maximum VSWR, 4 dB Bit**

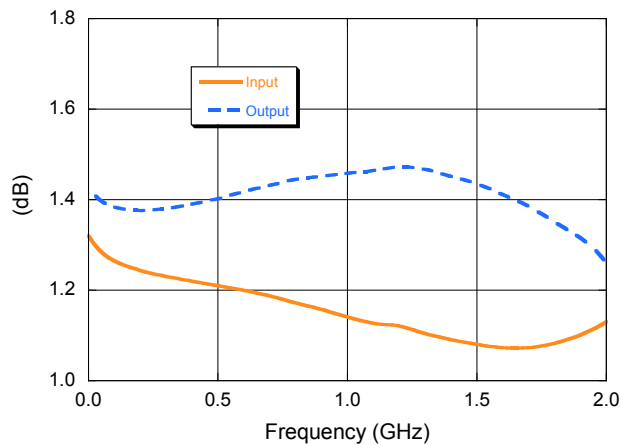

**Maximum VSWR, 8 dB Bit**

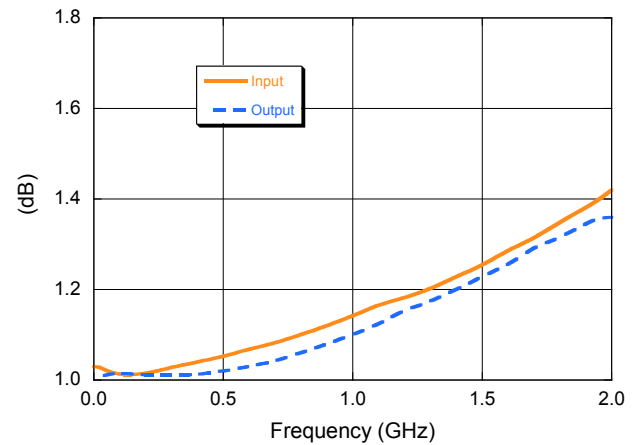

## Typical Performance Curves

Maximum VSWR, 16 dB Bit

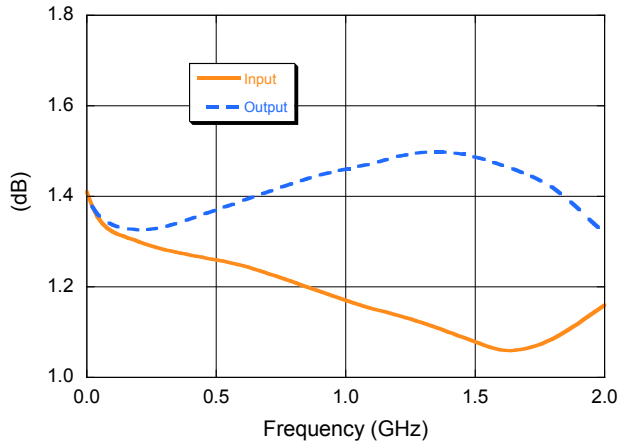

Maximum VSWR, 31 dB Bit

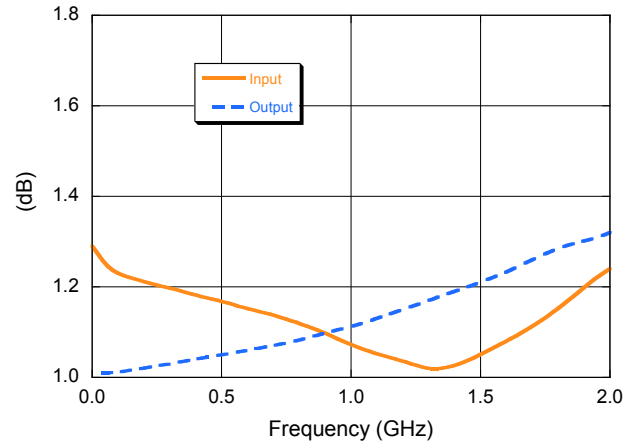

## Lead-Free, SOW-16<sup>†</sup>

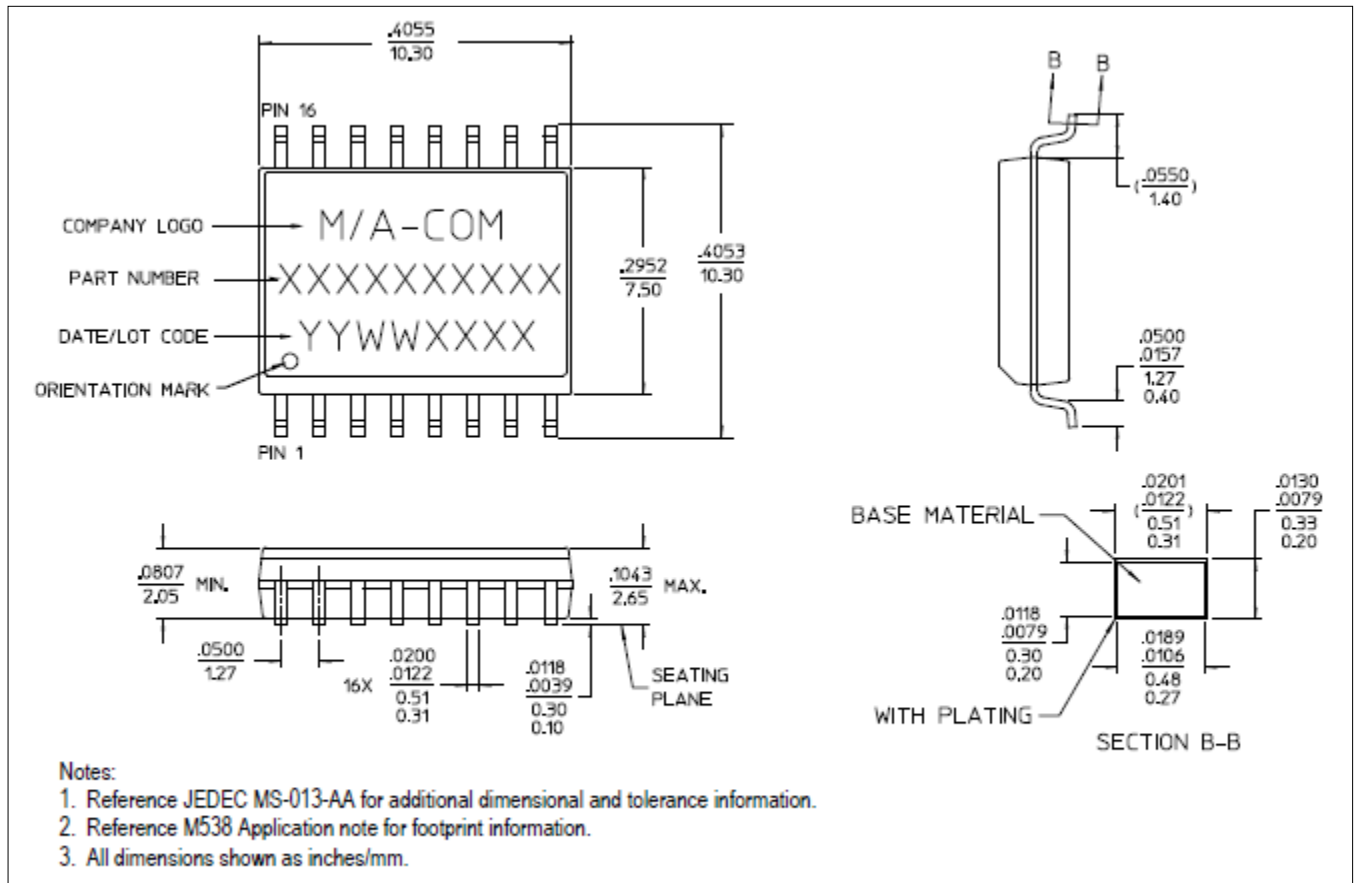

6 <sup>†</sup> Reference Application Note M538 for lead-free solder reflow recommendations.

MACOM Technology Solutions Inc. All rights reserved.

Information in this document is provided in connection with MACOM Technology Solutions Inc ("MACOM") products. These materials are provided by MACOM as a service to its customers and may be used for informational purposes only. Except as provided in MACOM's Terms and Conditions of Sale for such products or in any separate agreement related to this document, MACOM assumes no liability whatsoever. MACOM assumes no responsibility for errors or omissions in these materials. MACOM may make changes to specifications and product descriptions at any time, without notice. MACOM makes no commitment to update the information and shall have no responsibility whatsoever for conflicts or incompatibilities arising from future changes to its specifications and product descriptions. No license, express or implied, by estoppel or otherwise, to any intellectual property rights is granted by this document.

THESE MATERIALS ARE PROVIDED "AS IS" WITHOUT WARRANTY OF ANY KIND, EITHER EXPRESS OR IMPLIED, RELATING TO SALE AND/OR USE OF MACOM PRODUCTS INCLUDING LIABILITY OR WARRANTIES RELATING TO FITNESS FOR A PARTICULAR PURPOSE, CONSEQUENTIAL OR INCIDENTAL DAMAGES, MERCHANTABILITY, OR INFRINGEMENT OF ANY PATENT, COPYRIGHT OR OTHER INTELLECTUAL PROPERTY RIGHT. MACOM FURTHER DOES NOT WARRANT THE ACCURACY OR COMPLETENESS OF THE INFORMATION, TEXT, GRAPHICS OR OTHER ITEMS CONTAINED WITHIN THESE MATERIALS. MACOM SHALL NOT BE LIABLE FOR ANY SPECIAL, INDIRECT, INCIDENTAL, OR CONSEQUENTIAL DAMAGES, INCLUDING WITHOUT LIMITATION, LOST REVENUES OR LOST PROFITS, WHICH MAY RESULT FROM THE USE OF THESE MATERIALS.

MACOM products are not intended for use in medical, lifesaving or life sustaining applications. MACOM customers using or selling MACOM products for use in such applications do so at their own risk and agree to fully indemnify MACOM for any damages resulting from such improper use or sale.