

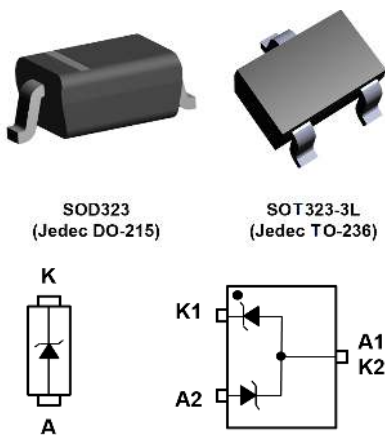

## Automotive 4 V TVS for BMS in SOD323 and SOT323



## Features

- AEC-Q101 qualified 
- Low leakage current: 50 nA max. at 3.6 V
- Low clamping during hot plug surges
- Unidirectional devices
- Protection of 2 battery cells in 1 package
- ECOPACK2 compliant component
- ISO 10605 / IEC 61000-4-2: C = 150 pF, R = 330 Ω, exceeds level 4
  - ±30 kV (air discharge)
  - ±30 kV (contact discharge)
- ISO 10605: C = 330 pF, R = 330 Ω, exceeds level 4
  - ±30 kV (air discharge)
  - ±30 kV (contact discharge)
- IEC 61000-4-4
- ISO 7637-3
  - Fast transient pulse a: Vs = -150 V
  - Fast transient pulse b: Vs = +150 V
  - Slow transient negative pulse: Vs = -85 V
  - Slow transient positive pulse: Vs = +85 V

## Product status link

[ESDA041-1JY](#)
[ESDA041-2W3Y](#)

## Application

Protection of battery monitoring systems (BMS) in electrical vehicle and hybrid electric vehicles such as e-bikes, cars and buses. The low clamping voltage during ESD and hot plug surges provides an efficient protection of the discrete and/or integrated MOS to ensure robustness and longevity of the battery management system. The low leakage current is compatible with a precise read-out of the state of charge of cells to maximize the global battery charge.

## Description

These ESDA041 devices are unidirectional single and dual line TVS protection devices designed to protect battery monitoring system (BMS) and other circuits around batteries against ESD transients and hot plug-in overshoots.

The dual TVS version in SOT323 provides space saving and cost effectiveness.

These devices are packaged in SOD323 and in SOT323-3L.

# 1 Characteristics

**Table 1. Absolute maximum ratings ( $T_{amb} = 25\text{ }^{\circ}\text{C}$ )**

| Symbol                                   | Parameter  | Value   | Unit               |    |
|--|--|---|--------------------|----|
| $V_{PP}$                                 | Peak pulse voltage                                 | ISO10605 / IEC 61000-4-2 (C = 150 pF, R = 330 $\Omega$ ): | kV                 |    |
|  |  | Contact discharge   |                    | 30 |
|  |  | Air discharge   |                    | 30 |
|  |  | ISO10605 (C = 330 pF, R = 330 $\Omega$ ):                 |                    | 30 |
|  |  | Contact discharge   |                    |    |
|  |  | Air discharge   |                    |    |
| ISO 10605 - C = 330 pF, R = 2 k $\Omega$ |  |   |                    |    |
| $I_{PP}$                                 | Peak pulse current                                 | 8/20 $\mu\text{s}$  | 20                 | A  |
| $T_j$                                    | Operating junction temperature range               | -55 to +150   | $^{\circ}\text{C}$ |    |
| $T_{stg}$                                | Storage temperature range                          | -55 to +150   | $^{\circ}\text{C}$ |    |
| $T_L$                                    | Maximum lead temperature for soldering during 10 s | 260   | $^{\circ}\text{C}$ |    |

**Figure 1. Electrical characteristics - parameter definitions**

$V_{RM}$  Maximum stand-off voltage  
 $I_{RM}$  Maximum leakage current @  $V_{RM}$   
 $V_R$  Stand-off voltage  
 $I_R$  Leakage current @  $V_R$   
 $V_{BR}$  Breakdown voltage @  $I_{BR}$   
 $I_{BR}$  Breakdown current  
 $V_{CL}$  Clamping voltage @  $I_{PP}$   
 $I_{PP}$  Peak pulse current  
 $R_D$  Dynamic resistance  
 $V_F$  Forward voltage drop @  $I_F$   
 $I_F$  Forward current  
 $\alpha T$  Voltage temperature coefficient

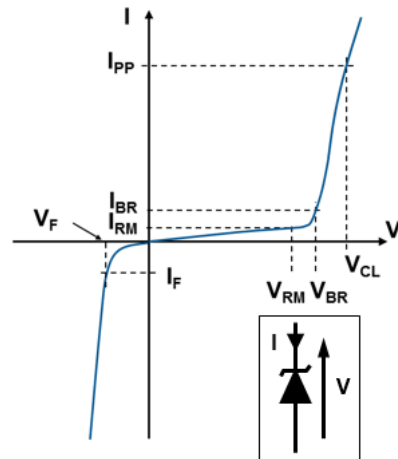
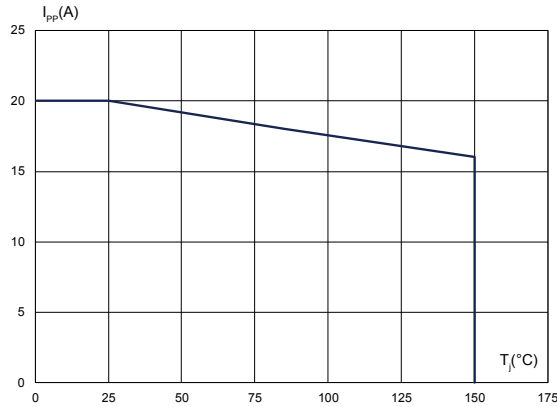

**Table 2. Electrical characteristics - parameter values ( $T_{amb} = 25\text{ }^{\circ}\text{C}$ , unless otherwise specified)**

| Type         | $I_{RM}$ max at $V_R$ |                       |     | $I_{RM}$ max at $V_{RM}$ |                       |   | $V_{BR}$ at 1 mA |      |      | $V_F$ at 10 mA |      | 8 / 20 $\mu\text{s}$ |          |          | C at 0 V |
|--------------|-----------------------|-----------------------|-----|--------------------------|-----------------------|---|------------------|------|------|----------------|------|----------------------|----------|----------|----------|
|              | 25 $^{\circ}\text{C}$ | 85 $^{\circ}\text{C}$ |     | 25 $^{\circ}\text{C}$    | 85 $^{\circ}\text{C}$ |   | Min.             | Typ. | Max. | Typ.           | Max. | $V_{CL}^{(1)}$       | $I_{PP}$ | $R_D$    | Typ.     |
|              | $\mu\text{A}$         |                       | V   | $\mu\text{A}$            |                       | V | V                | V    | V    | V              | V    | V                    | A        | $\Omega$ | pF       |
|              |                       |                       |     |                          |                       |   |                  |      |      |                |      |                      |          |          |          |
| ESDA041-1JY  | 0.05                  | 0.1                   | 3.6 | 0.1                      | 0.2                   | 4 | 6.2              | 6.5  | 6.8  | 0.78           | 0.9  | 9                    | 7        | 0.3      | 190      |
| ESDA041-2W3Y | 0.05                  | 0.1                   | 3.6 | 0.1                      | 0.2                   | 4 | 6.2              | 6.5  | 6.8  | 0.78           | 0.9  | 9                    | 7        | 0.3      | 190      |

 1. To calculate  $V_{CL}$  max versus  $I_{PP}$  appli:  $V_{CL} \text{ max} = V_{BR} \text{ max} + R_D \times I_{PP} \text{ appli}$ .

### 1.1 Characteristics (curves)

**Figure 2. Maximum peak current dissipation versus initial junction temperature**



**Figure 3. Maximum peak pulse current versus exponential pulse duration**

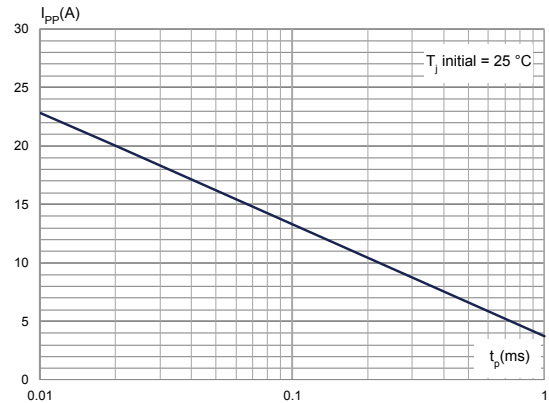

**Figure 4. Peak pulse current versus clamping voltage**

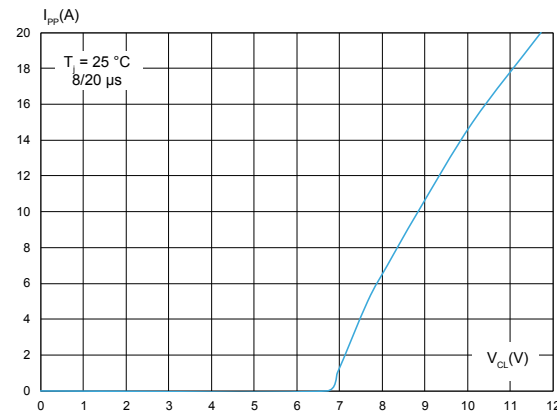

**Figure 5. Leakage current versus junction temperature**

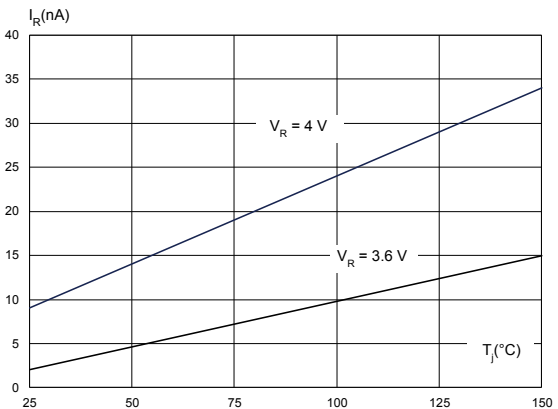

**Figure 6. Leakage current versus reverse voltage**

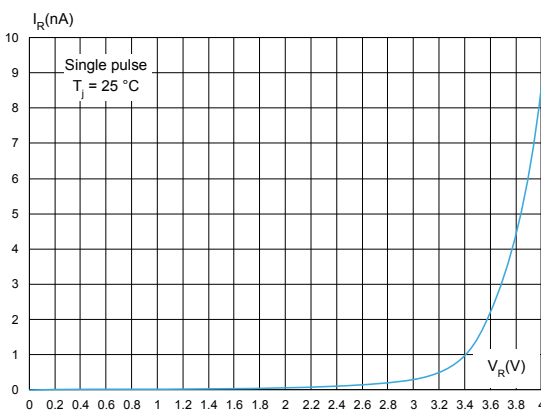

**Figure 7. Forward current versus forward voltage drop**

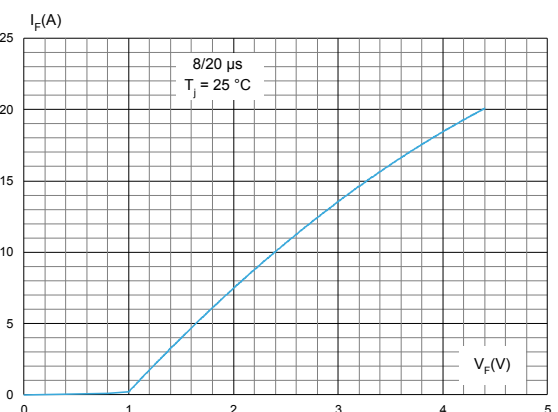

**Figure 8.** Response to ISO 10605 -C = 150 pF, R = 330 Ω (-8 kV contact)

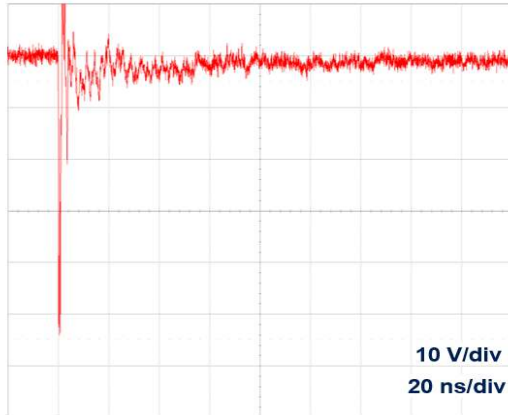

**Figure 9.** Response to ISO 10605 -C = 150 pF, R = 330 Ω (+8 kV contact)

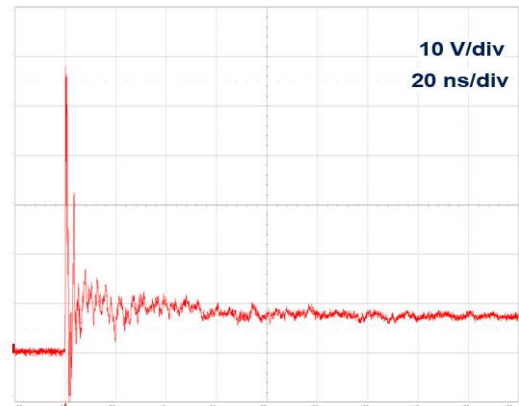

**Figure 10.** Response to ISO 7637-3 fast transient pulse a: -150 V

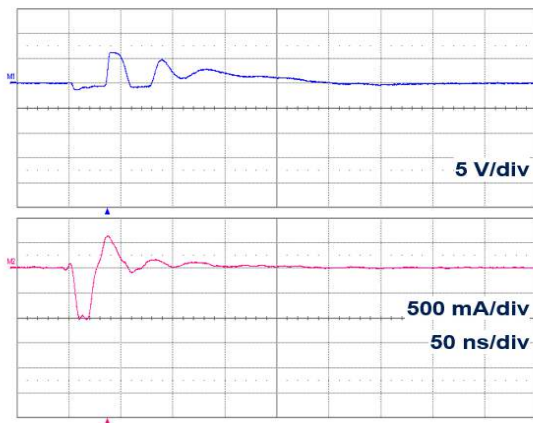

**Figure 11.** Response to ISO 7637-3 fast transient pulse b: +150 V

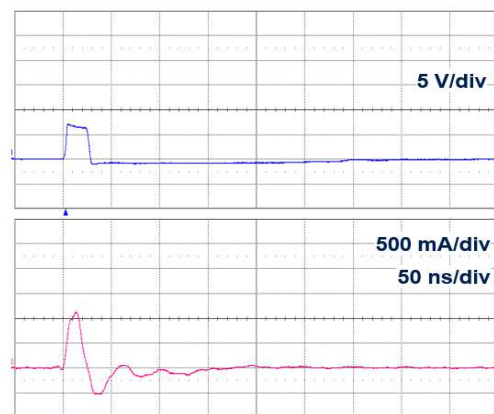

**Figure 12.** Response to ISO 7637-3 slow transient negative pulse: -85 V

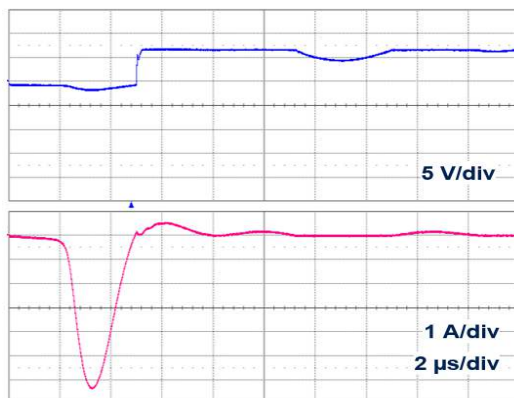

**Figure 13.** Response to ISO 7637-3 slow transient positive pulse: +85 V

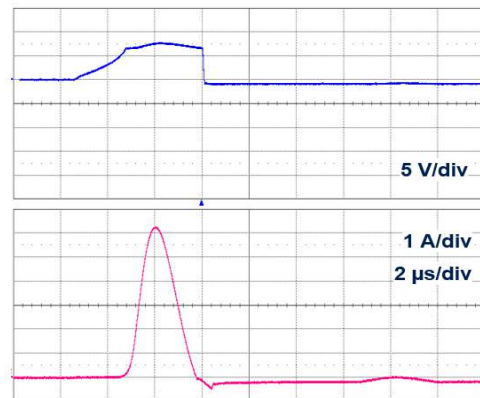
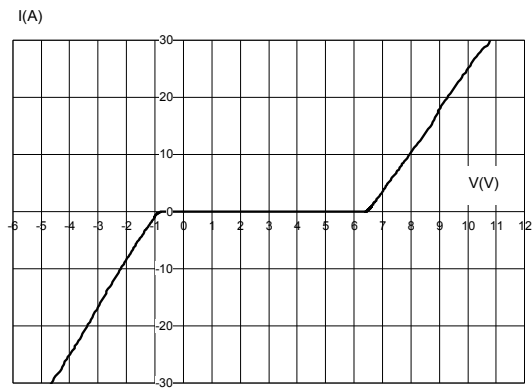

Figure 14. TLP



## 2 Package information

In order to meet environmental requirements, ST offers these devices in different grades of **ECOPACK** packages, depending on their level of environmental compliance. ECOPACK specifications, grade definitions and product status are available at: [www.st.com](http://www.st.com). ECOPACK is an ST trademark.

### 2.1 SOT323-3L package information

Figure 15. SOT323-3L package outline

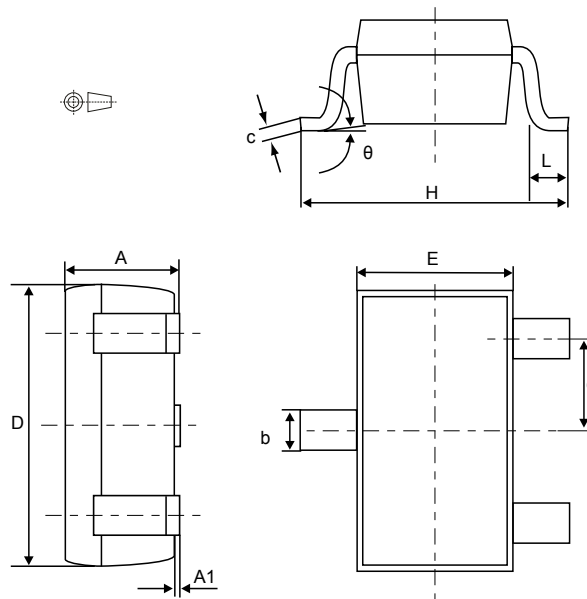

Table 3. SOT323-3L package mechanical data

| Ref. | Dimensions  |      |      |                       |       |       |
|------|-------------|------|------|-----------------------|-------|-------|
|      | Millimeters |      |      | Inches <sup>(1)</sup> |       |       |
|      | Min.        | Typ. | Max. | Min.                  | Typ.  | Max.  |
| A    | 0.80        |      | 1.10 | 0.031                 |       | 0.044 |
| A1   | 0.00        |      | 0.10 | 0.000                 |       | 0.004 |
| b    | 0.25        |      | 0.40 | 0.009                 |       | 0.016 |
| c    | 0.10        |      | 0.26 | 0.003                 |       | 0.011 |
| D    | 1.80        | 2.00 | 2.20 | 0.070                 | 0.079 | 0.087 |
| E    | 1.15        | 1.25 | 1.35 | 0.045                 | 0.049 | 0.054 |
| e    | 0.60        | 0.65 | 0.70 | 0.023                 | 0.026 | 0.028 |
| H    | 1.80        | 2.10 | 2.40 | 0.070                 | 0.083 | 0.095 |
| L    | 0.10        | 0.20 | 0.30 | 0.004                 | 0.008 | 0.012 |
| θ    |             | 0    | 30°  |                       | 0     | 30°   |

1. Values in inches are converted from mm and rounded to 3 decimal digits

## 2.2 SOT323-3L packing information

Figure 16. SOT323-3L footprint in mm

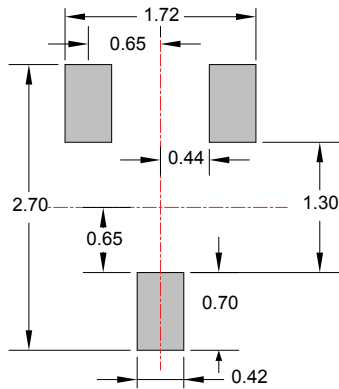

Figure 17. SOT323-3L marking

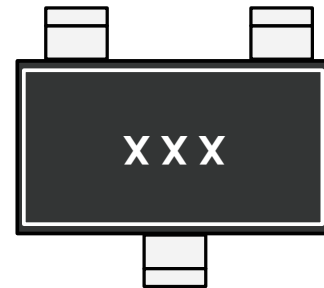
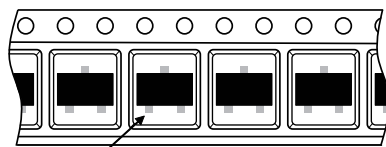

Figure 18. Package orientation in reel



Pin 1 located according to EIA-481

Note: Pocket dimensions are not on scale  
Pocket shape may vary depending on package

Figure 19. Tape and reel orientation

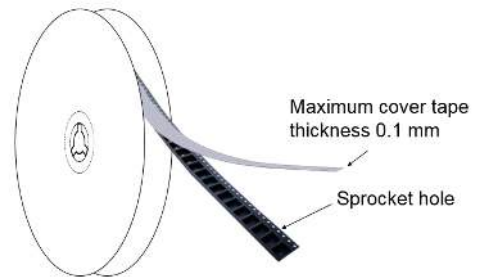

Figure 20. 7" reel dimension values

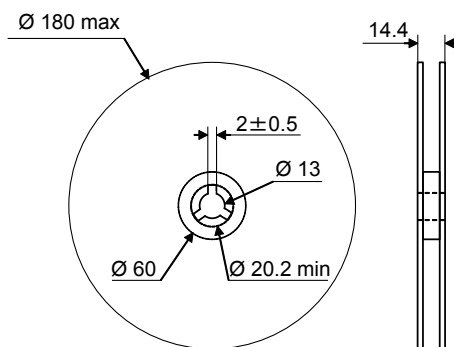
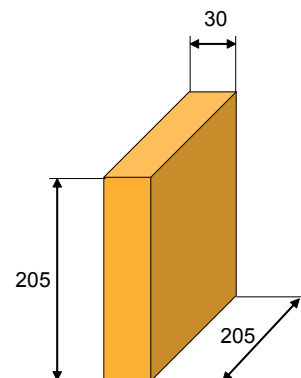
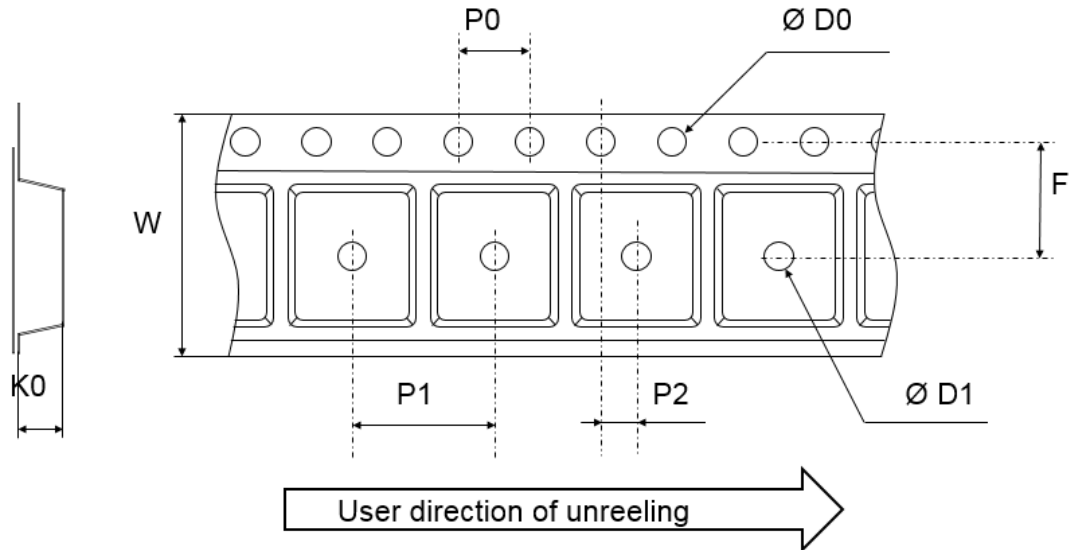

Figure 21. Inner box dimension values



**Figure 22. Tape outline**

Note: Pocket dimensions are not on scale  
 Pocket shape may vary depending on package

**Table 4. Tape dimension values**

| Ref. | Dimensions  |      |      |
|------|-------------|------|------|
|      | Millimeters |      |      |
|      | Min.        | Typ. | Max. |
| D0   | 1.50        | 1.55 | 1.6  |
| D1   | 1.00        |      |      |
| F    | 3.45        | 3.50 | 3.55 |
| K0   | 1.12        | 1.22 | 1.32 |
| P0   | 3.90        | 4.00 | 4.10 |
| P1   | 3.90        | 4.00 | 4.10 |
| P2   | 1.95        | 2.00 | 2.05 |
| W    | 7.90        | 8.00 | 8.30 |



### 2.3 SOD323 package information

Figure 23. SOD323 package outline

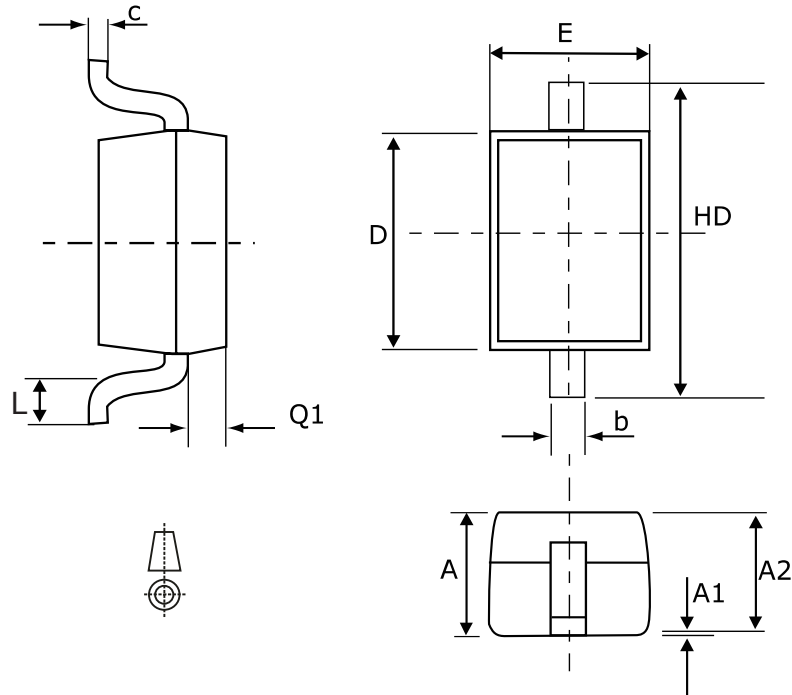
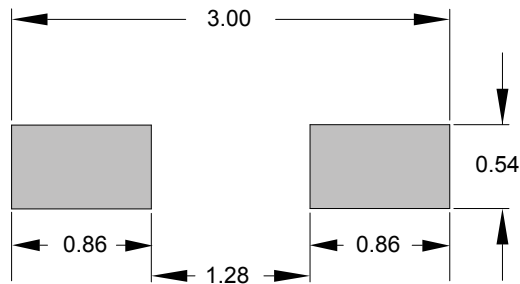
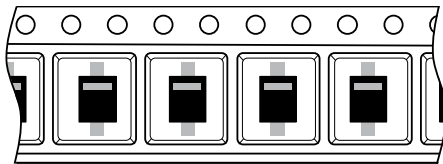

Table 5. SOD323 package mechanical data

| Ref. | Dimensions  |      |                       |       |
|------|-------------|------|-----------------------|-------|
|      | Millimeters |      | Inches <sup>(1)</sup> |       |
|      | Min.        | Max. | Min.                  | Max.  |
| A    |             | 1.17 |                       | 0.046 |
| A1   | 0.00        | 0.10 | 0.000                 | 0.004 |
| A2   |             |      |                       |       |
| b    | 0.25        | 0.44 | 0.010                 | 0.018 |
| c    | 0.10        | 0.25 | 0.003                 | 0.010 |
| D    | 1.52        | 1.80 | 0.059                 | 0.071 |
| E    | 1.11        | 1.45 | 0.043                 | 0.058 |
| HD   | 2.30        | 2.70 | 0.090                 | 0.107 |
| L    | 0.10        | 0.46 | 0.003                 | 0.019 |
| Q1   | 0.10        | 0.41 | 0.003                 | 0.017 |

1. Values in inches are converted from mm and rounded to 3 decimal digits

**2.4 SOD323 packing information**
**Figure 24. SOD323 footprint in mm**

**Figure 25. SOD323 marking**

**Figure 26. Package orientation in reel**

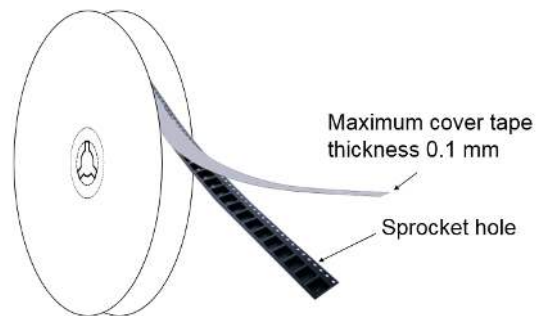
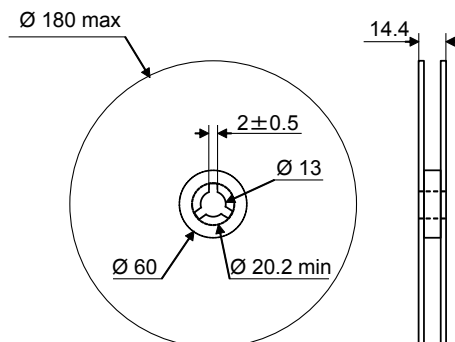
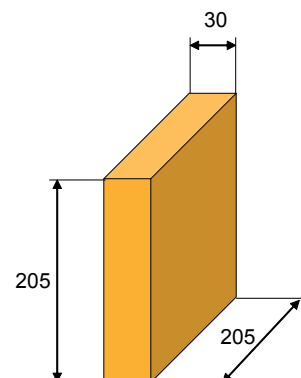
Taped according to EIA-481  
 Note: Pocket dimensions are not on scale  
 Pocket shape may vary depending on package

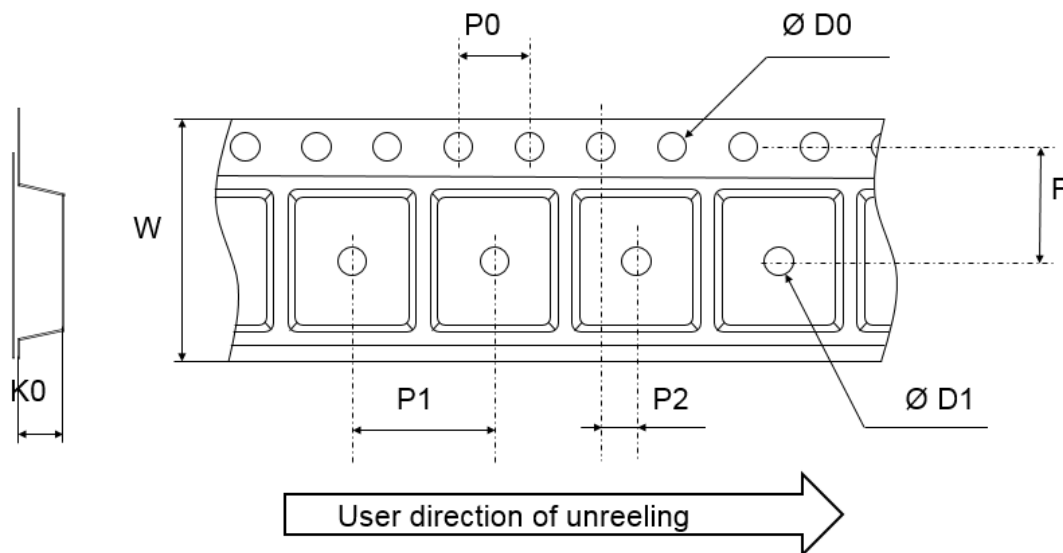
**Figure 27. Tape and reel orientation**

**Figure 28. 7" reel dimension values**

**Figure 29. Inner box dimension values**

**Figure 30. Tape outline**

Note: Pocket dimensions are not on scale  
 Pocket shape may vary depending on package

**Table 6. Tape dimension values**

| Ref. | Dimensions  |      |      |
|------|-------------|------|------|
|      | Millimeters |      |      |
|      | Min.        | Typ. | Max. |
| D0   | 1.50        | 1.55 | 1.6  |
| D1   | 1.00        |      |      |
| F    | 3.45        | 3.50 | 3.55 |
| K0   | 1.12        | 1.22 | 1.32 |
| P0   | 3.90        | 4.00 | 4.10 |
| P1   | 3.90        | 4.00 | 4.10 |
| P2   | 1.95        | 2.00 | 2.05 |
| W    | 7.90        | 8.00 | 8.30 |

## 2.5 Reflow profile

**Figure 31. ST ECOPACK recommended soldering reflow profile for PCB mounting**

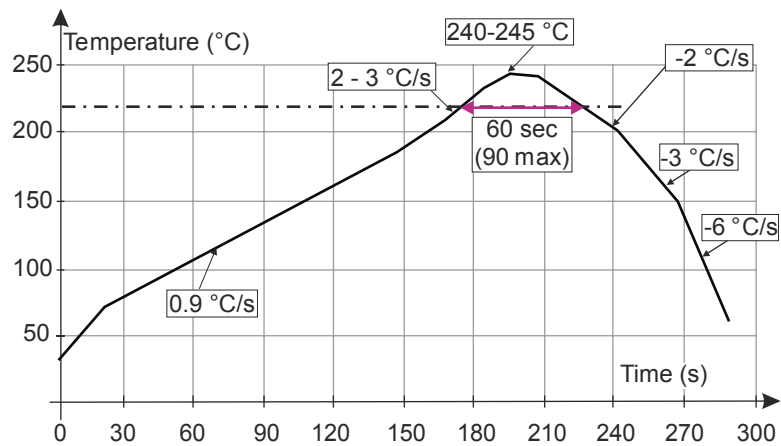

*Note:* Minimize air convection currents in the reflow oven to avoid component movement. Maximum soldering profile corresponds to the latest IPC/JEDEC J-STD-020.

## 2.6 Ordering information

**Table 7. Ordering information**

| Order code   | Marking | Package   | Weight  | Base qty. | Delivery mode |
|--------------|---------|-----------|---------|-----------|---------------|
| ESDA041-1JY  | B4      | SOD323    | 5.3 mg  | 3000      | Tape and reel |
| ESDA041-2W3Y | B41     | SOT323-3L | 6.56 mg | 3000      | Tape and reel |

## Revision history

**Table 8. Document revision history**

| Date        | Revision | Changes          |
|-------------|----------|------------------|
| 28-Oct-2019 | 1        | Initial release. |

**IMPORTANT NOTICE – PLEASE READ CAREFULLY**

STMicroelectronics NV and its subsidiaries (“ST”) reserve the right to make changes, corrections, enhancements, modifications, and improvements to ST products and/or to this document at any time without notice. Purchasers should obtain the latest relevant information on ST products before placing orders. ST products are sold pursuant to ST’s terms and conditions of sale in place at the time of order acknowledgement.

Purchasers are solely responsible for the choice, selection, and use of ST products and ST assumes no liability for application assistance or the design of Purchasers’ products.

No license, express or implied, to any intellectual property right is granted by ST herein.

Resale of ST products with provisions different from the information set forth herein shall void any warranty granted by ST for such product.

ST and the ST logo are trademarks of ST. For additional information about ST trademarks, please refer to [www.st.com/trademarks](http://www.st.com/trademarks). All other product or service names are the property of their respective owners.

Information in this document supersedes and replaces information previously supplied in any prior versions of this document.

© 2019 STMicroelectronics – All rights reserved