

STRADELLA-HB-S

~25° spot beam for industrial applications

SPECIFICATION:

Dimensions	13.9 x 13.9 mm
Height	7.5 mm
Fastening	pin
ROHS compliant	yes ⓘ

MATERIALS:

Component	Type	Material	Colour	Finish
STRADELLA-HB-S	Single lens	PMMA	clear	

ORDERING INFORMATION:

Component	Qty in box	MOQ	MPQ	Box weight (kg)
C15245_STRADELLA-HB-S » Box size: 480 x 250 x 390 mm	16000	1000	1000	9.0



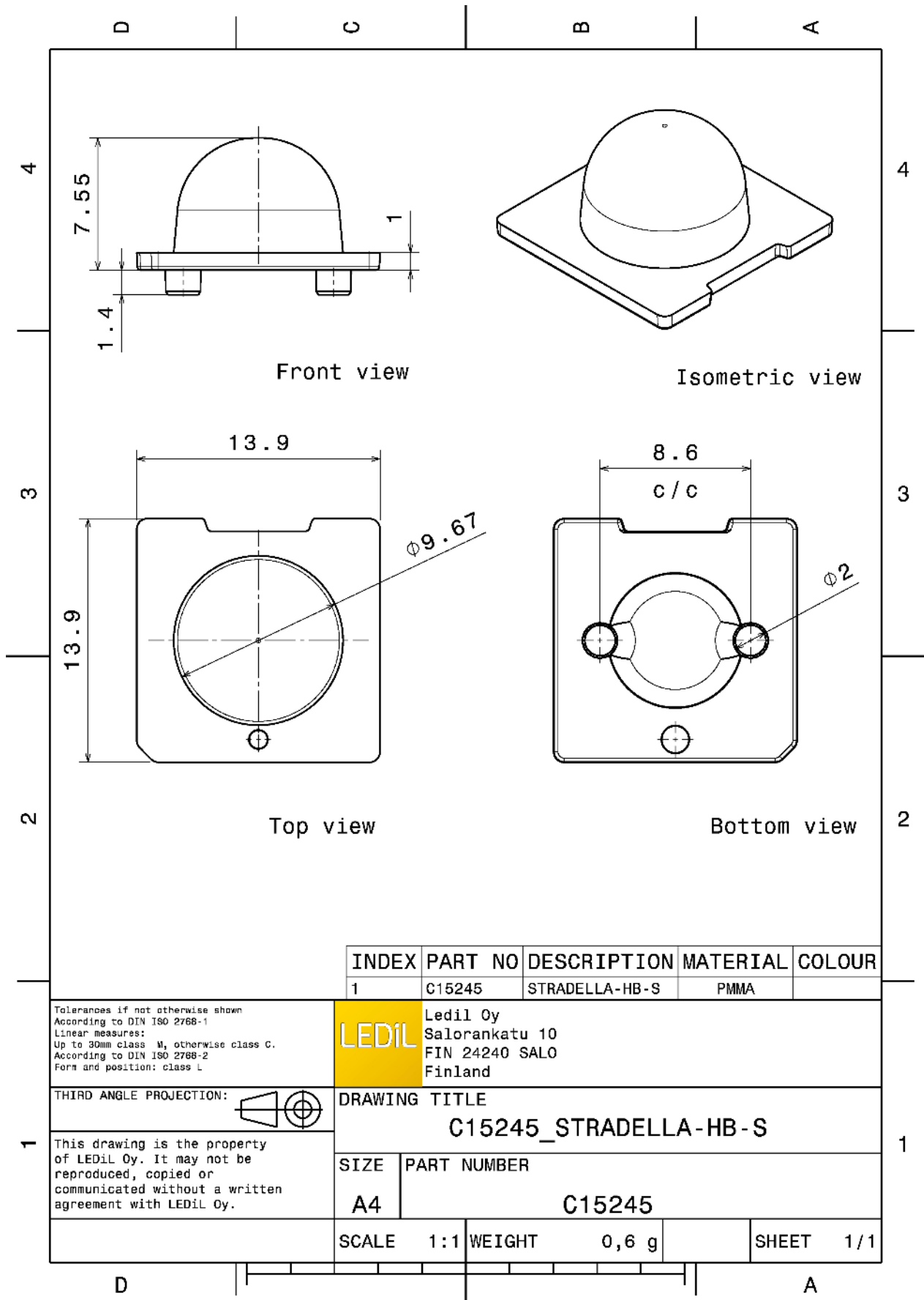

INDEX	PART NO	DESCRIPTION	MATERIAL	COLOUR
1	C15245	STRADELLA-HB-S	PMMA	

Tolerances if not otherwise shown
 According to DIN ISO 2768-1
 Linear measures:
 Up to 30mm class M, otherwise class C.
 According to DIN ISO 2768-2
 Form and position: class L

LEDiL Ledil Oy
 Salorankatu 10
 FIN 24240 SALO
 Finland

THIRD ANGLE PROJECTION:

DRAWING TITLE
C15245_STRADELLA-HB-S

This drawing is the property of LEDiL Oy. It may not be reproduced, copied or communicated without a written agreement with LEDiL Oy.

SIZE	PART NUMBER
A4	C15245

SCALE	1:1	WEIGHT	0,6 g	SHEET	1/1
-------	-----	--------	-------	-------	-----

See also our general installation guide: www.ledil.com/installation_guide

OPTICAL RESULTS (MEASURED):

CREE → LED

LED J Series 3030
 FWHM / FWTM 29.0° / 75.0°
 Efficiency 96 %
 Peak intensity 1.8 cd/lm
 LEDs/each optic 1
 Light colour White
 Required components:

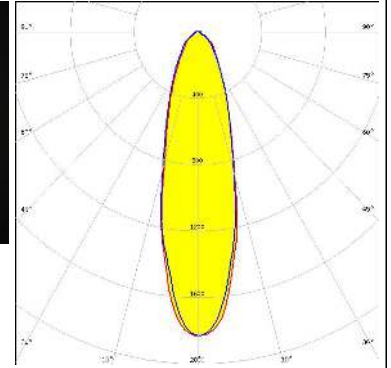
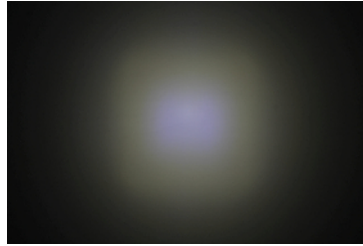

CREE → LED

LED XT-E
 FWHM / FWTM 27.0° / 81.0°
 Efficiency 92 %
 Peak intensity 1.6 cd/lm
 LEDs/each optic 1
 Light colour White
 Required components:

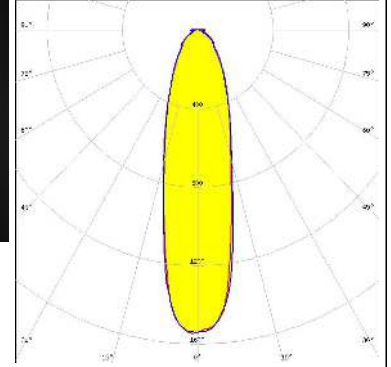

NICHIA

LED NVSW219D
 FWHM / FWTM 32.0° / 78.0°
 Efficiency 94 %
 Peak intensity 1.7 cd/lm
 LEDs/each optic 1
 Light colour White
 Required components:

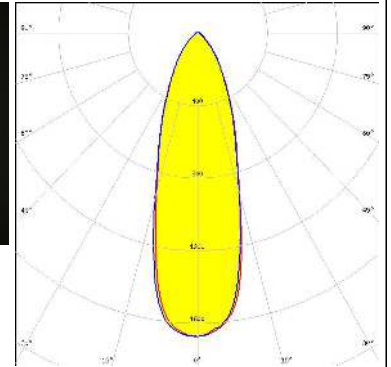
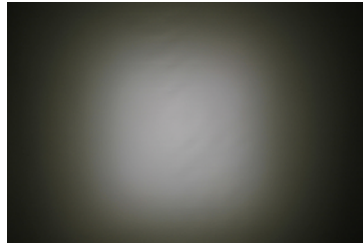

NICHIA

LED NVSW319B
 FWHM / FWTM 37.0° / 91.0°
 Efficiency 94 %
 Peak intensity 1.3 cd/lm
 LEDs/each optic 1
 Light colour White
 Required components:

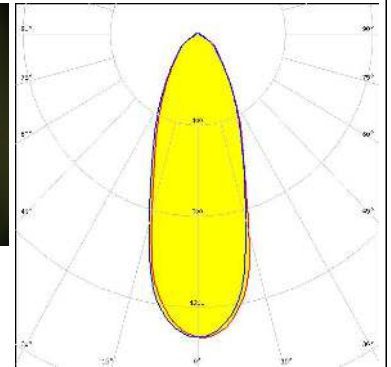

OPTICAL RESULTS (MEASURED):

SAMSUNG

LED LH181B
FWHM / FWTM 23.0° / 65.0°
Efficiency 94 %
Peak intensity 2.2 cd/lm
LEDs/each optic 1
Light colour White
Required components:

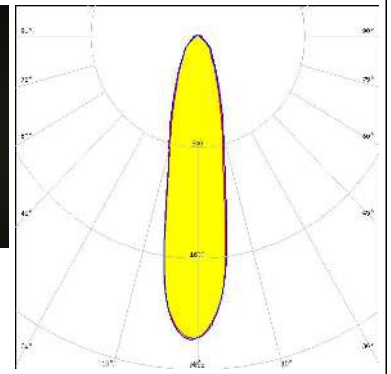

OPTICAL RESULTS (SIMULATED):

CREE LED

LED XP-G2 HE
 FWHM / FWTM 37.0° / 88.0°
 Efficiency 93 %
 Peak intensity 1.4 cd/lm
 LEDs/each optic 1
 Light colour White
 Required components:

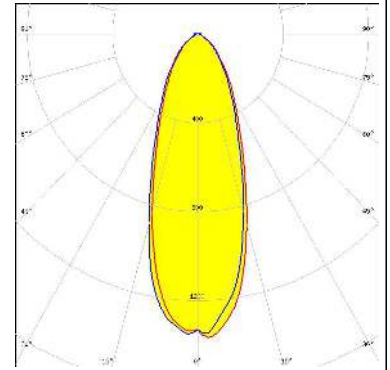

LUMILEDS

LED LUXEON IR Domed 150
 FWHM / FWTM 23.0° / 83.0°
 Efficiency 92 %
 LEDs/each optic 1
 Light colour White
 Required components:

NICHIA

LED NF2W585AR-P8
 FWHM / FWTM 25.0 + 34.0° / 76.0 + 86.0°
 Efficiency 94 %
 Peak intensity 1.7 cd/lm
 LEDs/each optic 1
 Light colour White
 Required components:

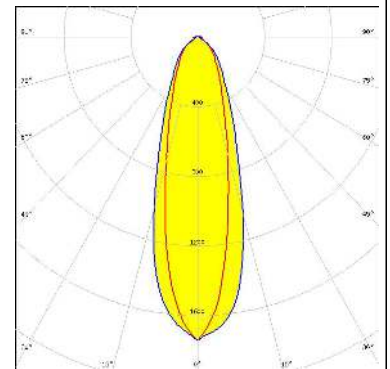

NICHIA

LED NVSW219F
 FWHM / FWTM 36.0° / 88.0°
 Efficiency 93 %
 Peak intensity 1.5 cd/lm
 LEDs/each optic 1
 Light colour White
 Required components:

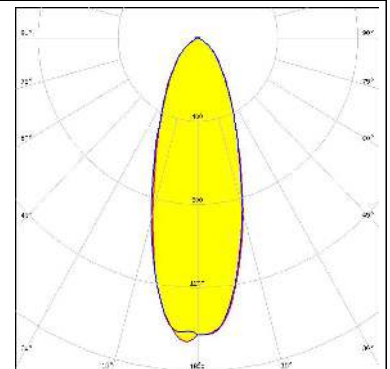

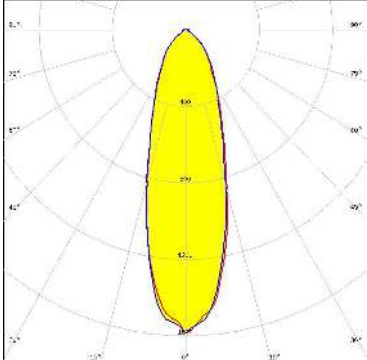
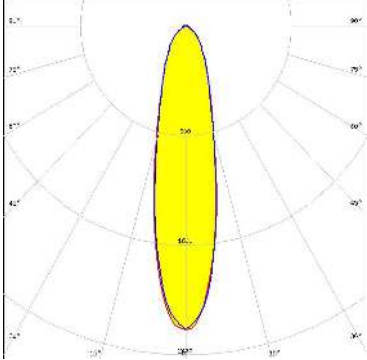
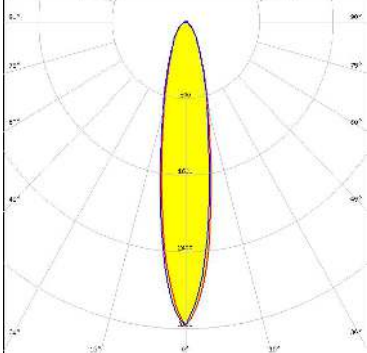

OPTICAL RESULTS (SIMULATED):

<p>NICHIA</p> <p>LED NVSW519A FWHM / FWTM 43.0° / 94.0° Efficiency 91 % Peak intensity 1.2 cd/lm LEDs/each optic 1 Light colour White Required components:</p>	
<p>NICHIA</p> <p>LED NVSxx19B/NVSxx19C FWHM / FWTM 31.0° / 86.0° Efficiency 93 % Peak intensity 1.6 cd/lm LEDs/each optic 1 Light colour White Required components:</p>	
<p>OSRAM <small>Opto Semiconductors</small></p> <p>LED OSCONIQ C 2424 FWHM / FWTM 24.0° / 70.0° Efficiency 94 % Peak intensity 2.2 cd/lm LEDs/each optic 1 Light colour White Required components:</p>	
<p>OSRAM <small>Opto Semiconductors</small></p> <p>LED OSCONIQ P 3030 FWHM / FWTM 20.0° / 55.0° Efficiency 95 % Peak intensity 3.2 cd/lm LEDs/each optic 1 Light colour White Required components:</p>	

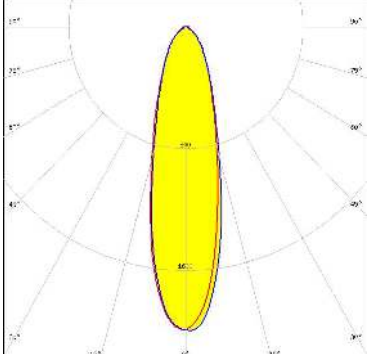
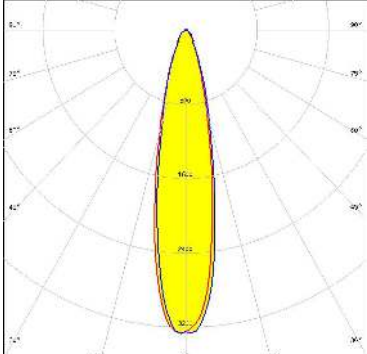
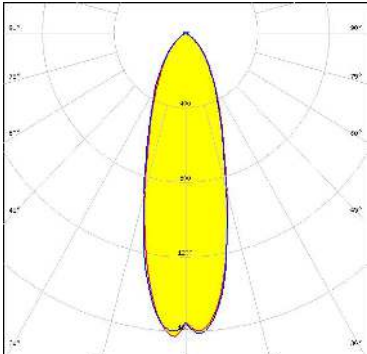
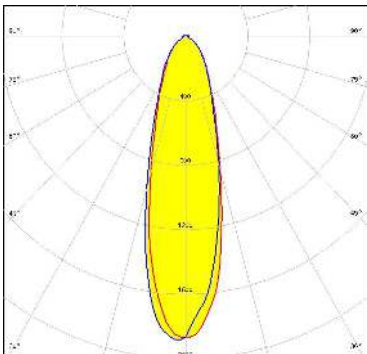
OPTICAL RESULTS (SIMULATED):

<p>OSRAM Opto Semiconductors</p> <p>LED: OSCONIQ P 3737 (2W version)</p> <p>FWHM / FWTM: 27.0° / 74.0°</p> <p>Efficiency: 94 %</p> <p>Peak intensity: 2 cd/lm</p> <p>LEDs/each optic: 1</p> <p>Light colour: White</p> <p>Required components:</p>	
<p>OSRAM Opto Semiconductors</p> <p>LED: OSLOM SSL 80</p> <p>FWHM / FWTM: 22.0° / 50.0°</p> <p>Efficiency: 94 %</p> <p>Peak intensity: 3.3 cd/lm</p> <p>LEDs/each optic: 1</p> <p>Light colour: White</p> <p>Required components:</p>	
<p>SAMSUNG</p> <p>LED: LH351B</p> <p>FWHM / FWTM: 32.0° / 81.0°</p> <p>Efficiency: 90 %</p> <p>Peak intensity: 1.7 cd/lm</p> <p>LEDs/each optic: 1</p> <p>Light colour: White</p> <p>Required components:</p>	
<p>SAMSUNG</p> <p>LED: LM28xB Series</p> <p>FWHM / FWTM: 28.0° / 77.0°</p> <p>Efficiency: 94 %</p> <p>Peak intensity: 1.9 cd/lm</p> <p>LEDs/each optic: 1</p> <p>Light colour: White</p> <p>Required components:</p>	

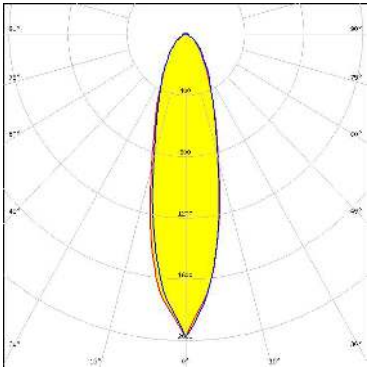
OPTICAL RESULTS (SIMULATED):

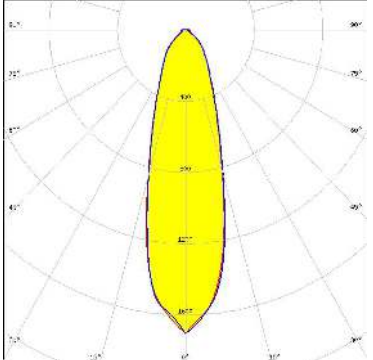
<p> SEOL SEMICONDUCTOR</p> <p>LED Z5M1/Z5M2</p> <p>FWHM / FWTM 27.0° / 73.0°</p> <p>Efficiency 94 %</p> <p>Peak intensity 2 cd/lm</p> <p>LEDs/each optic 1</p> <p>Light colour White</p> <p>Required components:</p>	
<p> SEOL SEMICONDUCTOR</p> <p>LED Z8Y22T</p> <p>FWHM / FWTM 30.0° / 80.0°</p> <p>Efficiency 93 %</p> <p>Peak intensity 1.7 cd/lm</p> <p>LEDs/each optic 1</p> <p>Light colour White</p> <p>Required components:</p>	

GENERAL INFORMATION:

NOTE: The typical beam angle will be changed by different color, chip size and chip position tolerance. The typical total beam angle is the full angle measured where the luminous intensity is half of the peak value.

MATERIALS:

As part of our continuous research and improvement processes, and to ensure the best possible quality and availability of our products, LEDiL reserves the right to change material grades without notice.

PRODUCT DATA USER AGREEMENT AND DISCLAIMER:

The measured data in the provided downloadable LEDiL Product Datasheets and Mechanical 2D-Drawings is rounded and provided as reference for planning. LEDiL Oy's optical specifications have been verified by conducting performance testing of the products in accordance with the company's quality system. The reported data are averaged results of multiple measurements with typical variation. LEDiL Oy reserves the right to without prior notification make changes and improvements to its products.

LEDiL Oy assumes neither warranty, nor guarantee nor any other liability of any kind for the contents and correctness of the provided data. The provided data has been generated with highest diligence but the provided data may in reality not represent the complete possible variation range of all intrinsic parameters. Therefore, in certain cases a deviation from the provided data could occur.

LEDiL Oy reserves the right to undertake technical changes of its products without further notification which could lead to changes in the provided data. LEDiL Oy assumes no liability of any kind for the possible deviation from any provided data or any other damage resulting from the usage of the provided data.

The user agrees to this disclaimer and user agreement with the download or usage of the provided files.

LEDiL Oy

Joensuunkatu 13
FI-24240 SALO
Finland

LEDiL Inc.

228 West Page Street
Suite D
Sycamore IL 60178
USA

Ledil Optics Technology (Shenzhen) Co., Ltd.

405 , Block B
Casic Motor Building
Shenzhen 518057
P.R.CHINA

Local sales and technical support

[www.ledil.com/
where_to_buy](http://www.ledil.com/where_to_buy)

Shipping locations

Salo, Finland
Hong Kong, China

Distribution Partners

[www.ledil.com/
where_to_buy](http://www.ledil.com/where_to_buy)