

170924-1 ✓ ACTIVE

MATE-N-LOK | Commercial MATE-N-LOK

TE Internal #: 170924-1

Rectangular Power Connectors, Housing, Receptacle, Wire-to-Wire,  
2 Position, 5.08 mm [.2 in] Centerline, Wire & Cable, UL 94V-2,  
Commercial MATE-N-LOK

[View on TE.com >](#)



Connectors > Power Connectors > Rectangular Power > Rectangular Power Connectors



Rectangular Power Connector Type: **Housing**

Connector & Housing Type: **Receptacle**

Connector System: **Wire-to-Wire**

Number of Positions: **2**

Centerline (Pitch): **5.08 mm [.2 in]**

## Features

### Product Type Features

Rectangular Power Connector Type	Housing
Connector & Housing Type	Receptacle
Connector System	Wire-to-Wire
Sealable	No
Connector & Contact Terminates To	Wire & Cable

### Configuration Features

Number of Positions	2
Number of Rows	1

### Electrical Characteristics

Operating Voltage	250 VDC
-------------------	---------

### Contact Features

Contact Layout	Inline
Contact Retention Within Housing	Without
Contact Type	Pin



### Termination Features

Termination Method to Wire & Cable	Crimp
------------------------------------	-------

### Mechanical Attachment

Panel Mount Feature	Without
Connector Mounting Type	Cable Mount (Free-Hanging)

### Housing Features

Centerline (Pitch)	5.08 mm [.2 in]
Housing Color	Natural
Housing Material	Nylon 66

### Dimensions

.031 – .064 in

### Usage Conditions

Operating Temperature Range	-55 – 105 °C [-67 – 221 °F]
-----------------------------	-----------------------------

### Operation/Application

Circuit Application	Power & Signal
---------------------	----------------

### Identification Marking

Circuit Identification Feature	With
--------------------------------	------

### Industry Standards

CSA Rating	LR 16455
UL Rating	Certified, Recognized
Agency/Standard	CSA, UL
Approved Standards	UL E28476
UL Flammability Rating	UL 94V-2
Glow Wire Rating	Standard Part - Not Glow Wire

### Packaging Features

Packaging Quantity	500
Packaging Method	Bag

### Product Compliance

For compliance documentation, visit the product page on TE.com>

EU RoHS Directive 2011/65/EU	Compliant
------------------------------	-----------











EU ELV Directive 2000/53/EC	Compliant
China RoHS 2 Directive MIIT Order No 32, 2016	No Restricted Materials Above Threshold
EU REACH Regulation (EC) No. 1907/2006	Current ECHA Candidate List: JUNE 2023 (235) Candidate List Declared Against: JUNE 2023 (235) Does not contain REACH SVHC
Halogen Content	Low Halogen - Br, Cl, F, I < 900 ppm per homogenous material. Also BFR/CFR/PVC Free
Solder Process Capability	Not applicable for solder process capability

Product Compliance Disclaimer

This information is provided based on reasonable inquiry of our suppliers and represents our current actual knowledge based on the information they provided. This information is subject to change. The part numbers that TE has identified as EU RoHS compliant have a maximum concentration of 0.1% by weight in homogenous materials for lead, hexavalent chromium, mercury, PBB, PBDE, DBP, BBP, DEHP, DIBP, and 0.01% for cadmium, or qualify for an exemption to these limits as defined in the Annexes of Directive 2011/65/EU (RoHS2). Finished electrical and electronic equipment products will be CE marked as required by Directive 2011/65/EU. Components may not be CE marked. Additionally, the part numbers that TE has identified as EU ELV compliant have a maximum concentration of 0.1% by weight in homogenous materials for lead, hexavalent chromium, and mercury, and 0.01% for cadmium, or qualify for an exemption to these limits as defined in the Annexes of Directive 2000/53/EC (ELV). Regarding the REACH Regulation, the information TE provides on SVHC in articles for this part number is based on the latest European Chemicals Agency (ECHA) 'Guidance on requirements for substances in articles' posted at this URL: <https://echa.europa.eu/guidance-documents/guidance-on-reach>

## Compatible Parts

 <p>TE Part # 60619-5 CMNL SOK AUBR L/P</p>	 <p>TE Part # 60617-5 CMNL SOK AUBR L/P</p>	 <p>TE Part # 60618-5 CMNL PIN AUBR L/P</p>	 <p>TE Part # 60618-4 CMNL PIN PTPPHBZL/P</p>
 <p>TE Part # 60617-4 CMNL SOK PTPPHBZ L/P</p>	 <p>TE Part # 61174-1 CMNL PIN L/P PTBR</p>	 <p>TE Part # 61173-1 CMNL SOK 30-22 PTBR L/P</p>	 <p>TE Part # 60619-1 CMNL SOK PTPBR L/P</p>

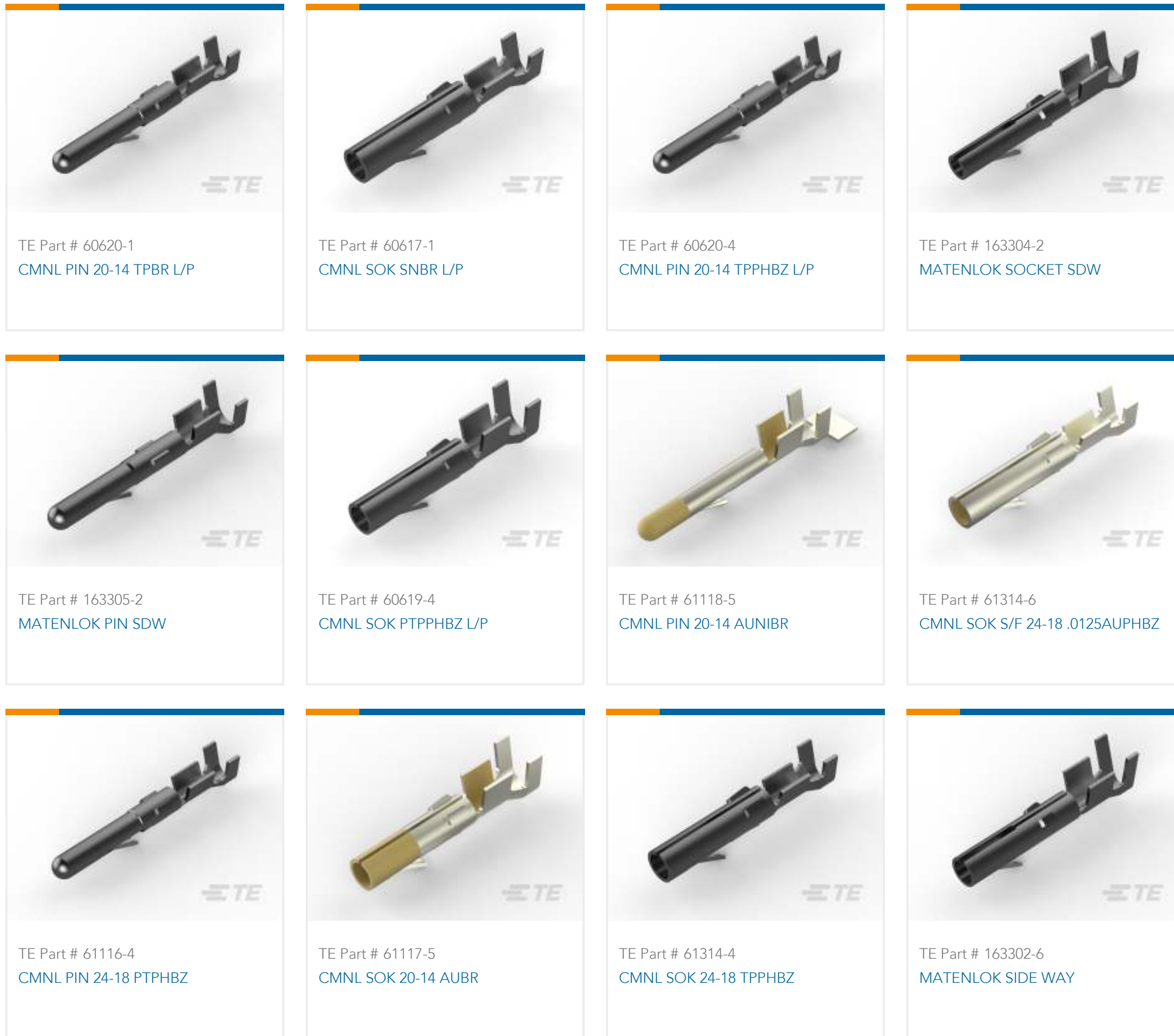

Also in the Series | Commercial MATE-N-LOK

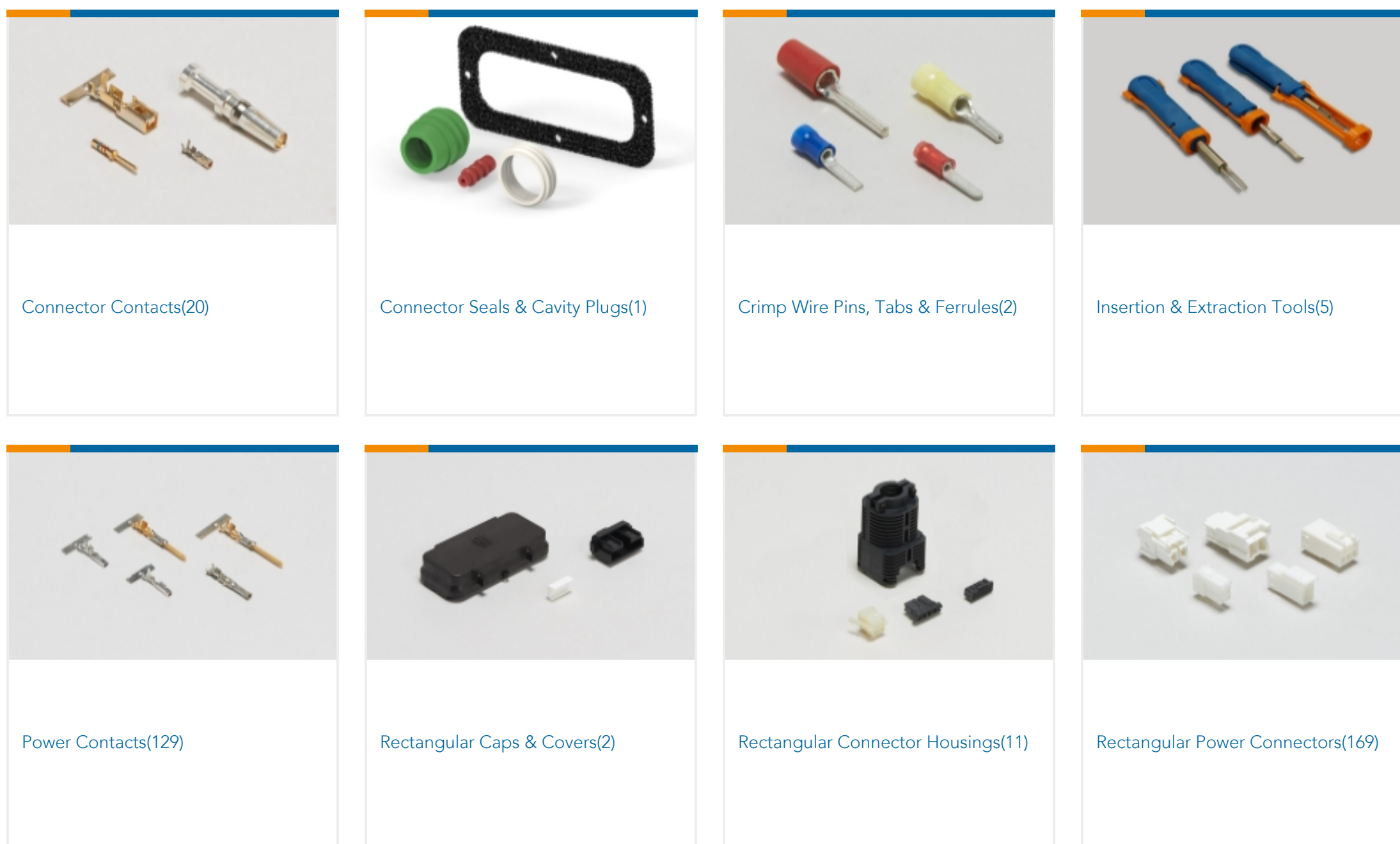





Standard Circular Connectors(2)

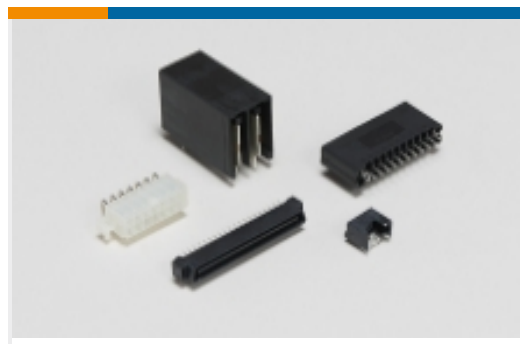

Standard Rectangular Connectors(7)



Wire-to-Board Connector Contacts(1)

## Customers Also Bought



TE Part #1-480304-0  
03P CMNL PLUG HSG P/M NATL



TE Part #60620-1  
CMNL PIN 20-14 TPBR L/P

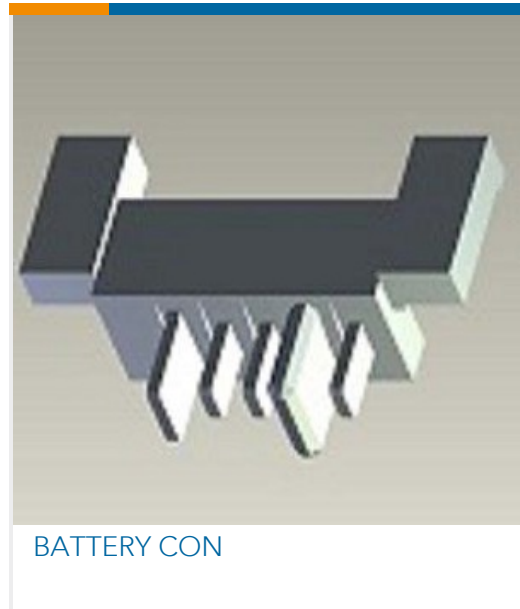

BATTERY CON



TE Part #1-480350-0  
01P CMNL CAP HSG F/H NATL



TE Part #7-1393104-4  
KRPA-14AN-24=KRPA

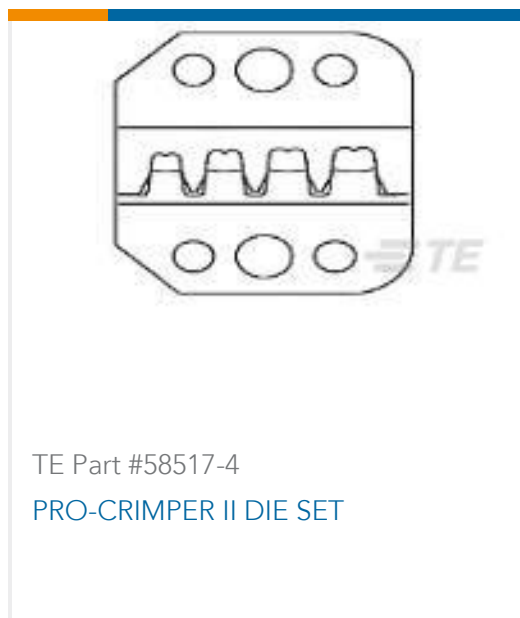

TE Part #58517-4  
PRO-CRIMPER II DIE SET

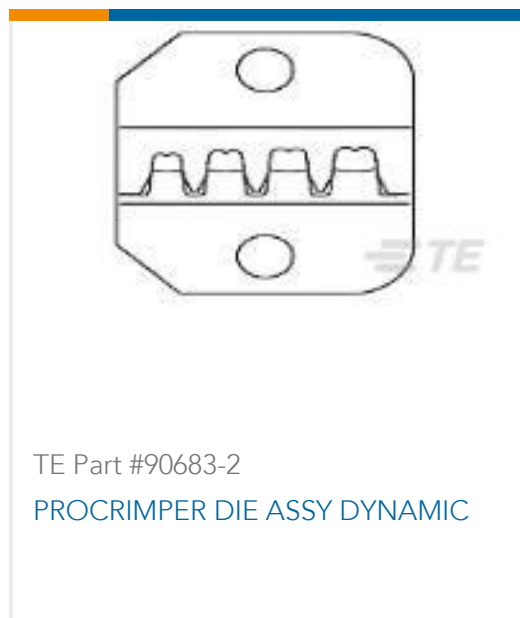

TE Part #90683-2  
PROCRIMPER DIE ASSY DYNAMIC



TE Part #1649326-6  
RTB14024

## Documents

### Product Drawings

MNL 2 POS NATURAL PIN HSG

English

### CAD Files

3D PDF

3D

Customer View Model

[ENG\\_CVM\\_CVM\\_170924-1\\_L.2d\\_dxf.zip](#)

English

Customer View Model

[ENG\\_CVM\\_CVM\\_170924-1\\_L.3d\\_igs.zip](#)

English

Customer View Model

[ENG\\_CVM\\_CVM\\_170924-1\\_L.3d\\_stp.zip](#)

English

By downloading the CAD file I accept and agree to the [Terms and Conditions](#) of use.



---

**Product Specifications**

**Application Specification**

English

---

**Product Environmental Compliance**

**Product Compliance**

English

**Product Compliance**

English

---

**Agency Approvals**

**Agency Approval Document**

English