

178216-3 ✓ ACTIVE

[Dynamic Series](#) | [Dynamic 3000 Series](#)

TE Internal #: 178216-3

PCB Mount Header, Horizontal, Wire-to-Board, 12 Position, 3.81 mm [.15 in] Centerline, Fully Shrouded, Gold, Dynamic 3000 Series

[View on TE.com >](#)



Connectors > PCB Connectors > PCB Headers & Receptacles > Header Assembly: Wire-to-Board, 15A, gold or tin plated



Connector System: **Wire-to-Board**

Number of Positions: **12**

Number of Rows: **4**

Centerline (Pitch): **3.81 mm [.15 in]**

PCB Mount Orientation: **Horizontal**

[All Header Assembly: Wire-to-Board, 15A, gold or tin plated \(11\)](#)

Features

Product Type Features

Connector System	Wire-to-Board
Header Type	Fully Shrouded
Sealable	No
Connector & Contact Terminates To	Printed Circuit Board
PCB Connector Assembly Type	PCB Mount Header

Configuration Features

Number of Positions	12
Number of Rows	4
PCB Mount Orientation	Horizontal

Body Features

Primary Product Color	Black
-----------------------	-------

Contact Features

Contact Mating Area Plating Material Thickness	.76 μ m[30 μ in]
Contact Mating Area Plating Material	Gold
Contact Type	Pin
Contact Current Rating (Max)	8 A



Termination Features

Termination Method to Printed Circuit Board	Through Hole - Solder
---	-----------------------

Mechanical Attachment

Mating Alignment Type	Polarization
-----------------------	--------------

Mating Retention	With
------------------	------

PCB Mount Retention Type	Retention Leg
--------------------------	---------------

Connector Mounting Type	Board Mount
-------------------------	-------------

Mating Alignment	With
------------------	------

PCB Mount Alignment	Without
---------------------	---------

PCB Mount Retention	With
---------------------	------

Housing Features

Housing Material	Polyester GF
------------------	--------------

Centerline (Pitch)	3.81 mm [.15 in]
--------------------	------------------

Usage Conditions

Operating Temperature Range	-55 – 105 °C [-67 – 221 °F]
-----------------------------	-----------------------------

Operation/Application

Circuit Application	Power & Signal
---------------------	----------------

Industry Standards

UL Flammability Rating	UL 94V-0
------------------------	----------

Packaging Features

Packaging Type	Box, Tube
----------------	-----------

Product Compliance

[For compliance documentation, visit the product page on TE.com>](#)

EU RoHS Directive 2011/65/EU	Compliant
------------------------------	-----------

EU ELV Directive 2000/53/EC	Compliant
-----------------------------	-----------

China RoHS 2 Directive MIIT Order No 32, 2016	No Restricted Materials Above Threshold
---	---

EU REACH Regulation (EC) No. 1907/2006	Current ECHA Candidate List: JUNE 2023 (235) Candidate List Declared Against: JAN 2023 (233) Does not contain REACH SVHC
--	--

Halogen Content	Not Low Halogen - contains Br or Cl > 900 ppm.
-----------------	--

Solder Process Capability

Wave solder capable to 265°C

Product Compliance Disclaimer

This information is provided based on reasonable inquiry of our suppliers and represents our current actual knowledge based on the information they provided. This information is subject to change. The part numbers that TE has identified as EU RoHS compliant have a maximum concentration of 0.1% by weight in homogenous materials for lead, hexavalent chromium, mercury, PBB, PBDE, DBP, BBP, DEHP, DIBP, and 0.01% for cadmium, or qualify for an exemption to these limits as defined in the Annexes of Directive 2011/65/EU (RoHS2). Finished electrical and electronic equipment products will be CE marked as required by Directive 2011/65/EU. Components may not be CE marked. Additionally, the part numbers that TE has identified as EU ELV compliant have a maximum concentration of 0.1% by weight in homogenous materials for lead, hexavalent chromium, and mercury, and 0.01% for cadmium, or qualify for an exemption to these limits as defined in the Annexes of Directive 2000/53/EC (ELV). Regarding the REACH Regulation, the information TE provides on SVHC in articles for this part number is based on the latest European Chemicals Agency (ECHA) 'Guidance on requirements for substances in articles' posted at this URL: <https://echa.europa.eu/guidance-documents/guidance-on-reach>

Compatible Parts



Also in the Series | Dynamic 3000 Series

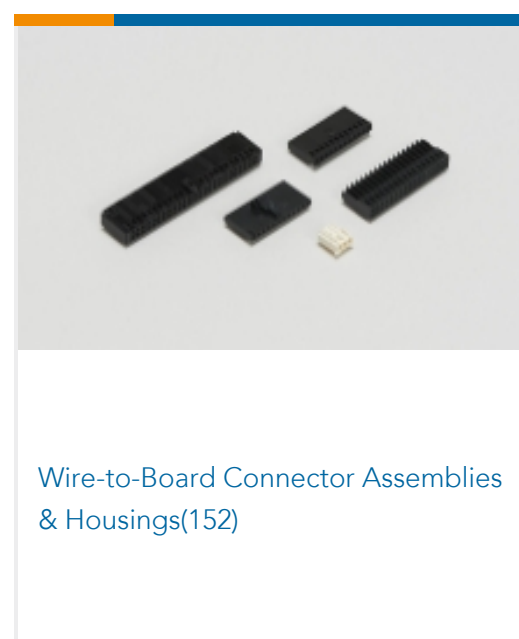
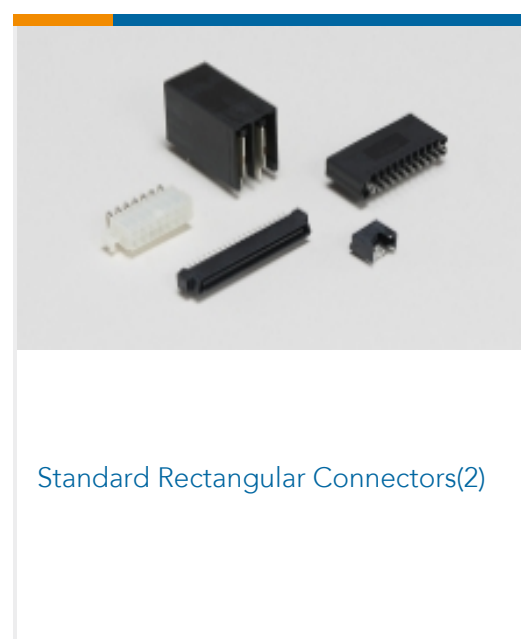
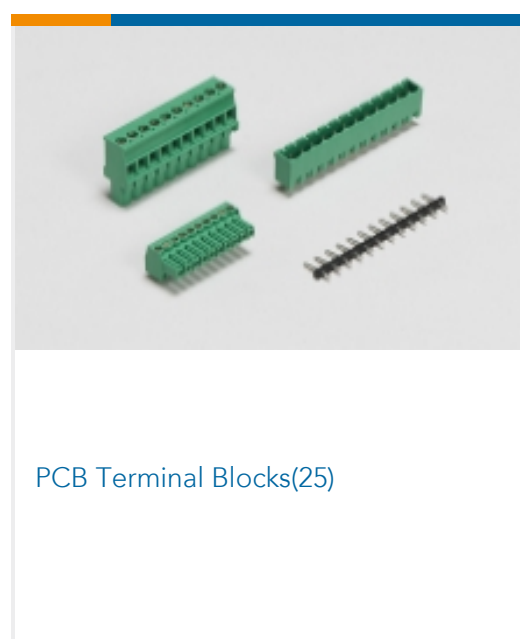
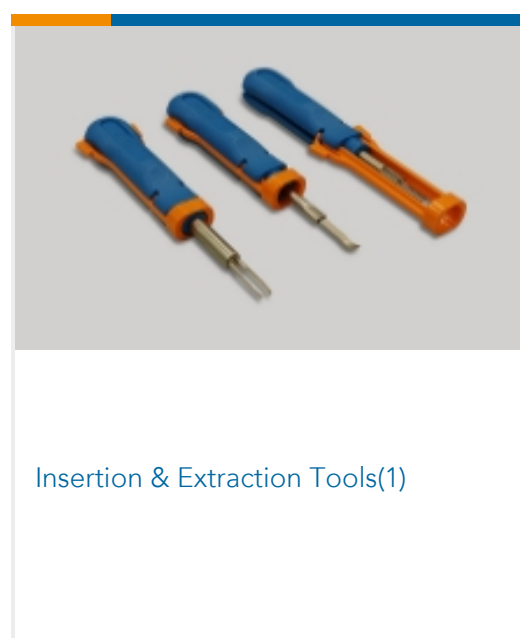
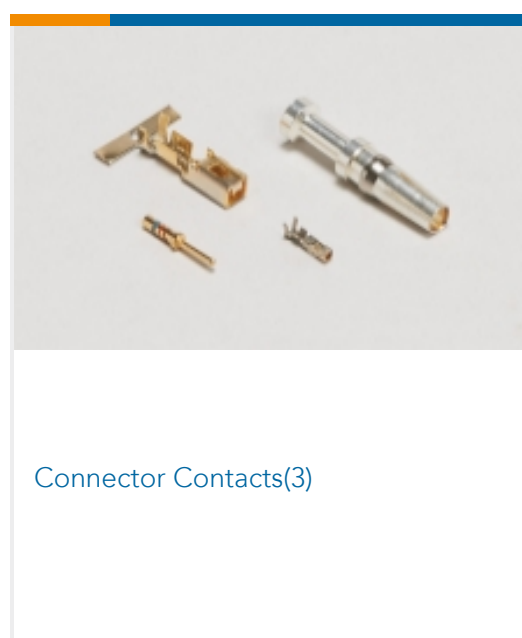



Wire-to-Board Connector Contacts(91)

Customers Also Bought

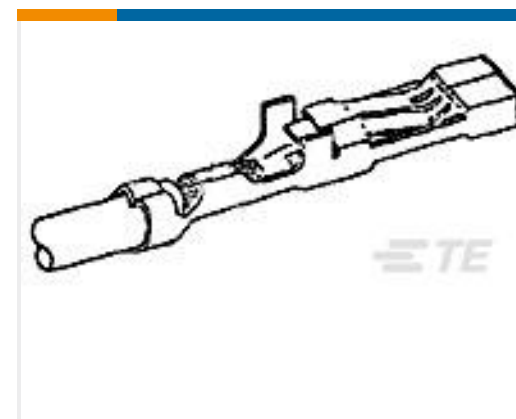
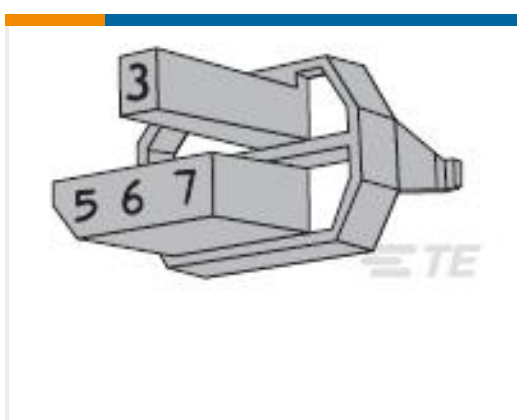
TE Part #178326-2
DYNAMIC DBL ROW HDR ASSY 12P VTE Part #5100161-1
Z-PACK/C RAF 55PTE Part #1558661-3
T9GV1L14-12TE Part #350689-7
UMNL SOK 24-18 AUBR L/PTE Part #5223961-1
TE UPM R/A Header 3P STD Power,
LLLTE Part #1766274-1
CONTACT,PIN,#0TE Part #175218-2
DYNAMIC REC CONTACT L L/PTE Part #170286-1
MIC REC CONTACTTE Part #3-100526-5
Z-PACK F.CODING KEY

Documents

CAD Files

[3D PDF](#)

[3D](#)

Customer View Model

[ENG_CVM_CVM_178216-3_G.2d_dxf.zip](#)

English

Customer View Model

[ENG_CVM_CVM_178216-3_G.3d_igs.zip](#)



English

Customer View Model

[ENG_CVM_CVM_178216-3_G.3d_stp.zip](#)

English

3D PDF

English

Customer View Model

[ENG_CVM_178216-3_E1.3d_igs.zip](#)

English

Customer View Model

[ENG_CVM_178216-3_E1.3d_stp.zip](#)

English

Customer View Model

[ENG_CVM_178216-3_E1.2d_dxf.zip](#)

English

By downloading the CAD file I accept and agree to the [Terms and Conditions](#) of use.

Datasheets & Catalog Pages

[1-1773732-4_DYNAMIC_SERIES_CATALOG_ENGLISH](#)

Japanese

[1-1773732-4_DYNAMIC_SERIES_CATALOG_ENGLISH](#)

English

Product Specifications

[Product Specification](#)

English

Product Environmental Compliance

[MD_178216-3_02032016727_dmtec](#)

English

[MD_178216-3_02032016727_dmtec](#)

English