

MOV S 4032

Surface mount metal oxide varistor



Product features

- Surface mount metal oxide varistor (MOV)
- 4032 (10182 metric) package size
- High transient current capability
- Plastic package meets UL 94 V-0
- Meets UL1449 4th edition
- Moisture sensitivity level (MSL): 1

Applications

- Power supply
- Home appliance
- Industrial equipment
- Telecommunication or telephone system
- Vac driven & COB LED lighting

Agency information

- cURus recognized:
File: E340782, Guide VZCA2 and VZCA8



Environmental compliance



Ordering part number

MOV S 4032 V011

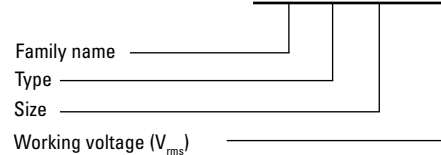

Electrical characteristics (+25 °C)

Part number	Working voltage		Varistor voltage @ 1 mAdc V_v (V) typical	Leakage current @ V_v * 80% (at initial state) IL (μ A) maximum	Clamping voltage 8/20 μ s V_c (V) maximum	Peak current 8/20 μ s i_{max} (A) maximum	Maximum energy (J) 10/1000 μ s	Rated power (W)	Typical capaci- tance (pF) 1.0 kHz	Component thickness T (mm) ± 0.3
	V_{rms} (V) maximum	V_{dc} (V) maximum								
MOVS4032V011	11	14	16.2~19.8	50	40 @ 2.5 A	250	0.9	0.02	3500	3.2
MOVS4032V014	14	18	19.8~24.2	50	48 @ 2.5 A	250	1.1	0.02	2850	3.2
MOVS4032V017	17	22	24.3~29.7	50	60 @ 2.5 A	250	1.4	0.02	2350	3.2
MOVS4032V020	20	26	29.7~36.3	50	73 @ 2.5 A	250	1.7	0.02	1900	4.2
MOVS4032V025	25	31	35.1~42.9	50	80 @ 2.5 A	250	2.1	0.02	1300	4.2
MOVS4032V030	30	38	42.3~51.7	50	104 @ 2.5 A	250	2.5	0.02	1060	4.2
MOVS4032V035	35	45	50.4~61.6	50	123 @ 2.5 A	250	3.1	0.02	890	4.2
MOVS4032V040	40	56	61.2~74.8	50	145 @ 2.5 A	250	3.6	0.02	730	4.2
MOVS4032V050	50	66	73.8~90.2	50	135 @ 10 A	1200	5.5	0.25	490	3.2
MOVS4032V060	60	85	90~110	50	165 @ 10 A	1200	6.5	0.25	450	3.2
MOVS4032V075	75	102	108~132	50	200 @ 10 A	1200	7.8	0.25	400	4.2
MOVS4032V095	95	127	135~165	50	250 @ 10 A	1200	9.7	0.25	300	4.2
MOVS4032V120	120	160	170~207	50	300 @ 10 A	1200	11.7	0.25	190	4.2
MOVS4032V130	130	175	185~225	50	340 @ 10 A	1200	13	0.25	160	4.2
MOVS4032V140	140	180	198~242	50	360 @ 10 A	1200	14	0.25	150	4.2
MOVS4032V150	150	200	216~264	50	395 @ 10 A	1200	15	0.25	145	4.2
MOVS4032V180	180	230	255~311	50	455 @ 10 A	1200	18	0.25	125	4.2
MOVS4032V195	195	250	270~330	50	500 @ 10 A	1200	20	0.25	115	4.2
MOVS4032V210	210	275	297~363	50	550 @ 10 A	1200	23	0.25	105	4.2
MOVS4032V230	230	300	324~396	50	595 @ 10 A	1200	25	0.25	110	4.2
MOVS4032V250	250	330	351~429	50	650 @ 10 A	1200	25	0.25	105	4.2
MOVS4032V275	275	370	387~473	50	710 @ 10 A	1200	28	0.25	95	5.6
MOVS4032V300	300	385	423~517	50	775 @ 10 A	1200	30	0.25	90	5.6
MOVS4032V320	320	420	459~561	50	845 @ 10 A	1200	30	0.25	85	5.6
MOVS4032V360	360	470	522~638	50	925 @ 10 A	1200	30	0.25	80	5.6
MOVS4032V390	390	505	558~682	50	1025 @ 10 A	1200	33	0.25	75	5.6
MOVS4032V420	420	560	612~748	50	1120 @ 10 A	1200	33	0.25	70	5.6
MOVS4032V460	460	615	675~825	50	1240 @ 10 A	1200	65	0.25	65	5.6
MOVS4032V485	485	640	702~858	50	1290 @ 10 A	1200	65	0.25	60	5.6
MOVS4032V510	510	670	738~902	50	1355 @ 10 A	1200	65	0.25	55	5.6

V_{RMS}/V_{DC} – Maximum operating voltage the varistor can maintain
 V_v – Voltage across the device measured at 1 mA DC current. Equivalent to V_b , “Breakdown Voltage”.
 V_c – Maximum peak voltage across the varistor measured at 8/20 us waveform.
 i_{max} – Maximum peak current which may be applied with 8/20 us waveform without device failure

Dimensions- mm

Drawing not to scale

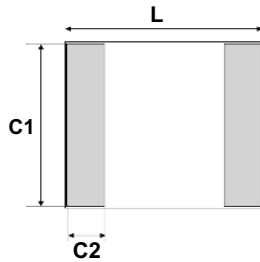
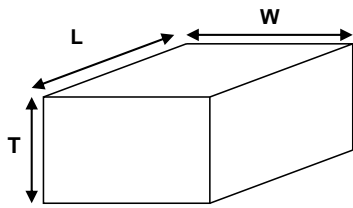

Bottom view

Recommended pad layout

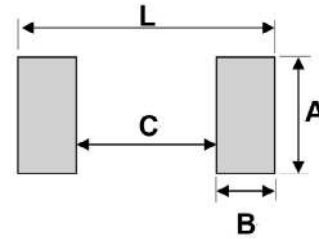

Dimension	Value	Note
L	10.1 ± 0.2	
W	8.2 ± 0.2	
T	3.2 ± 0.3 4.2 ± 0.3 5.6 ± 0.3	Refer to Electrical specifications table on pg 2
C1	7.4 ± 0.3	
C2	1.6 ± 0.3	

Dimension	Value
A	8.6
B	2.2
C	6.2
L	10.6

Part marking

Part number	Marking	Part number	Marking
MOVS4032V011	A	MOVS4032V150	P
MOVS4032V014	B	MOVS4032V180	Q
MOVS4032V017	C	MOVS4032V195	R
MOVS4032V020	D	MOVS4032V210	S
MOVS4032V025	E	MOVS4032V230	T
MOVS4032V030	F	MOVS4032V250	U
MOVS4032V035	G	MOVS4032V275	V
MOVS4032V040	H	MOVS4032V300	W
MOVS4032V050	I	MOVS4032V320	X
MOVS4032V060	J	MOVS4032V360	Y
MOVS4032V075	K	MOVS4032V390	Z
MOVS4032V095	L	MOVS4032V420	2
MOVS4032V120	M	MOVS4032V460	3
MOVS4032V130	N	MOVS4032V485	4
MOVS4032V140	O	MOVS4032V510	5

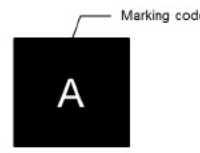

General specifications

Operating temperature: -40 °C to +85 °C

Storage temperature (on board): -40 °C to +85 °C

Solderability: +245 ± 5 °C, 3 ± 1 second

Solder leach resistance: +260 ± 5 °C, 10 ± 1 second

Packaging information - mm

900 pieces per reel for MOVS4032, T = 5.6 mm

1100 pieces per reel for MOVS4032, T = 4.2 mm

1400 pieces per reel for MOVS4032, T = 3.2 mm

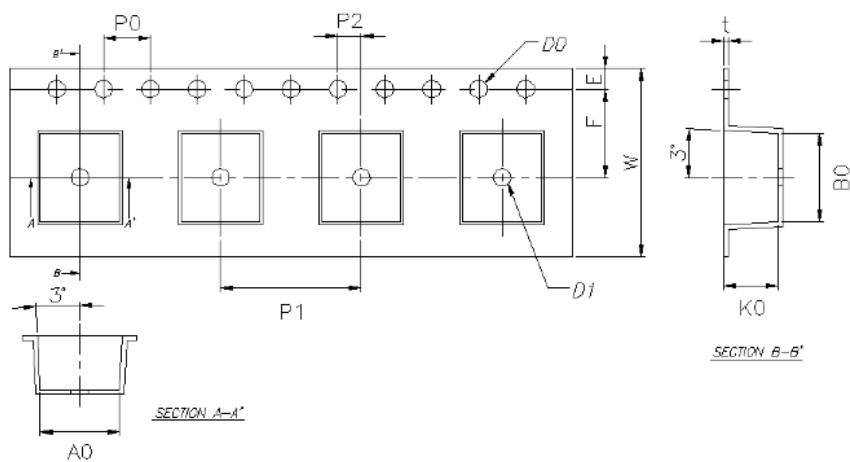

Dimension	Value
W	16.00 ± 0.30
E	1.75 ± 0.10
F	7.50 ± 0.15
D0	1.50 ± 0.10/-0.00
D1	1.50 ± 0.10/-0.00
P0	4.00 ± 0.10
P0 x10	40.0 ± 0.20
t	0.50 ± 0.05
A0	8.55 ± 0.15/-0.05
B0	10.45 ± 0.15/-0.05
K0	6.20 maximum
P1	12.00 ± 0.10
P2	2.00 ± 0.15

Reel dimension - mm

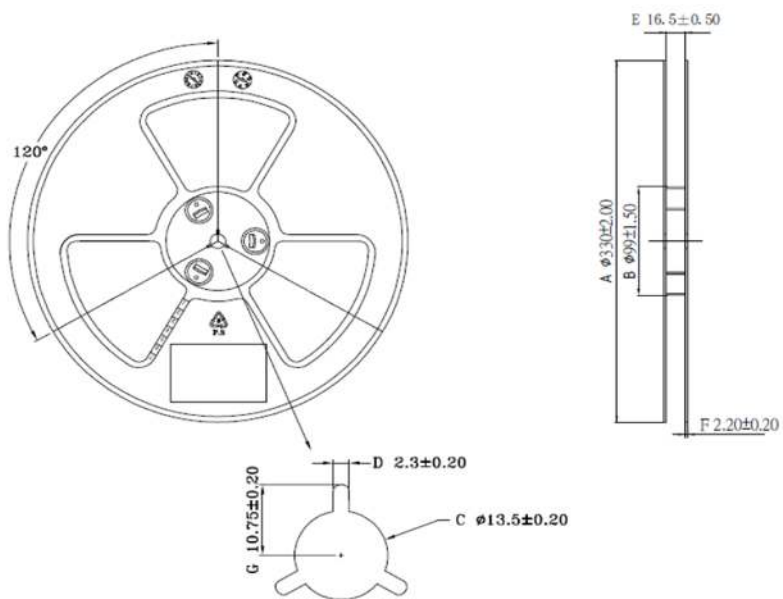

Dimension	Value
A	330 ± 2.00
B	99 ± 1.50
C	13.50 ± 0.20
D	2.30 ± 0.20
E	16.50 ± 0.50
F	2.20 ± 0.20
G	10.75 ± 0.20

Peak current, energy and power derating curve

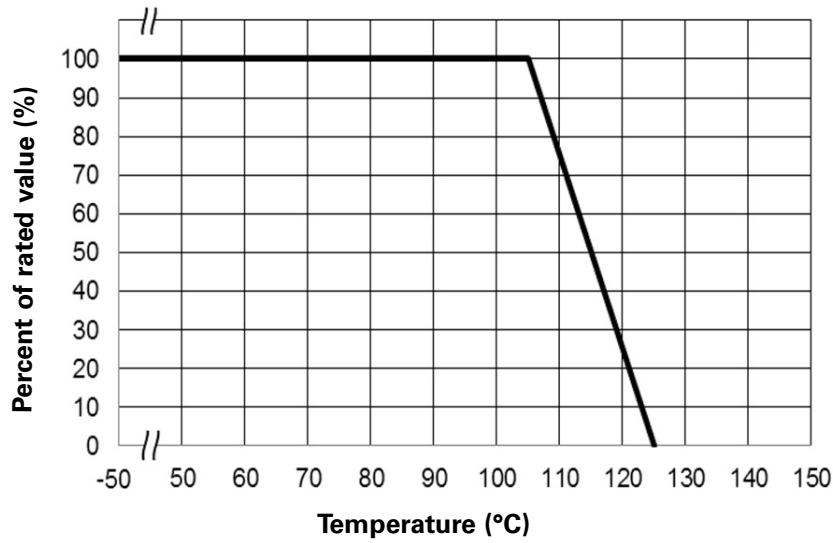

Voltage vs current (V-I) curves

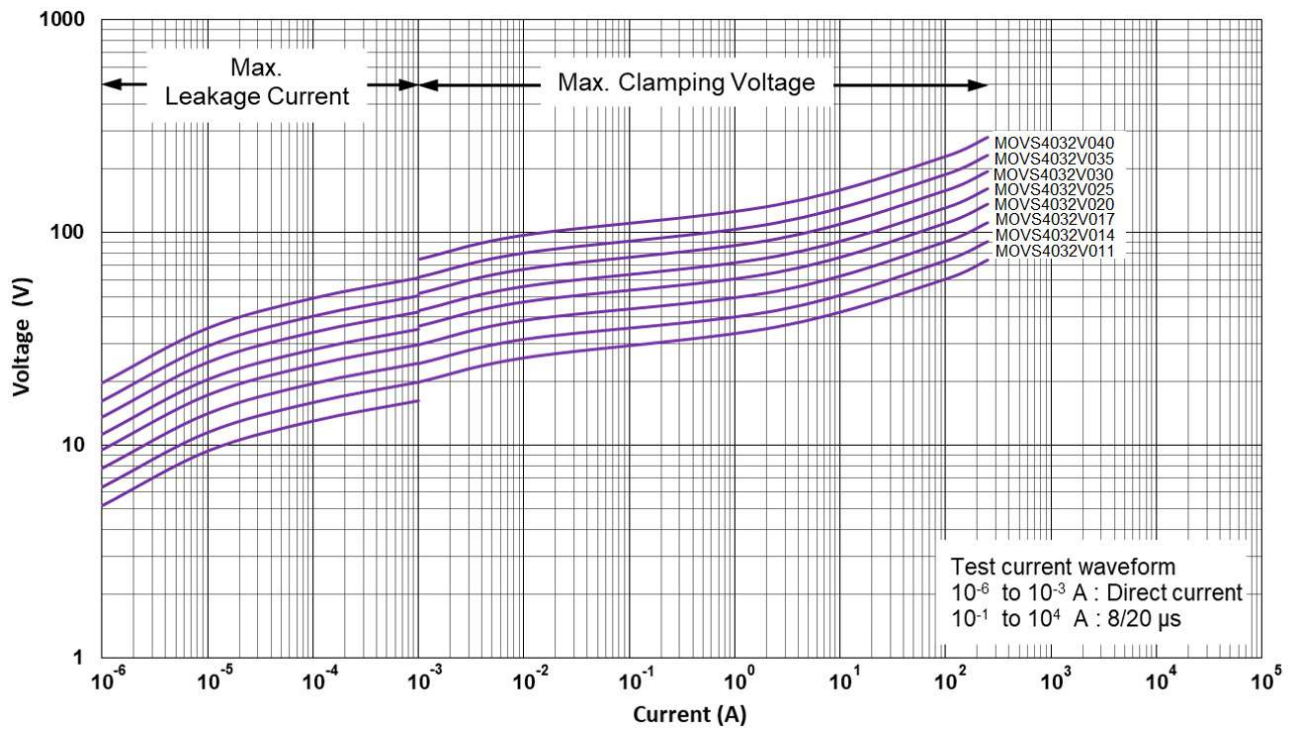

Voltage vs current (V-I) curves (continued)

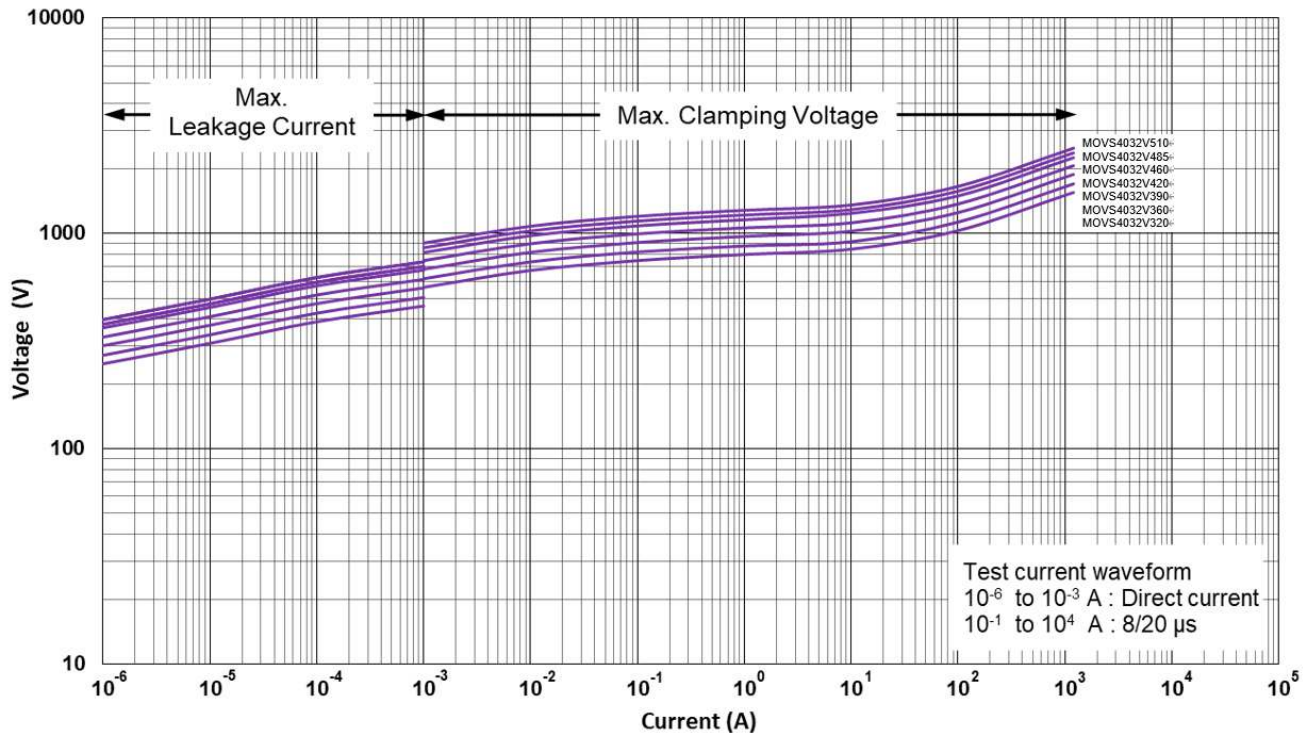
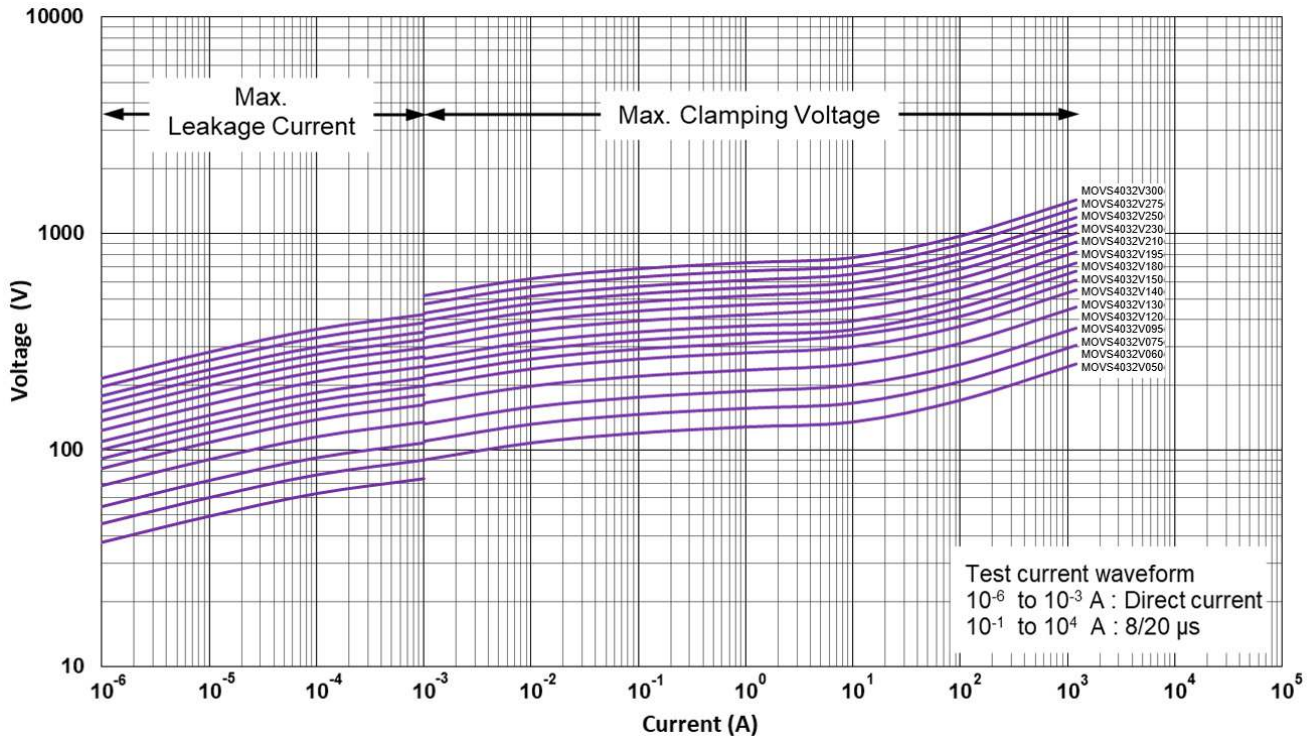

Pulse rating curve

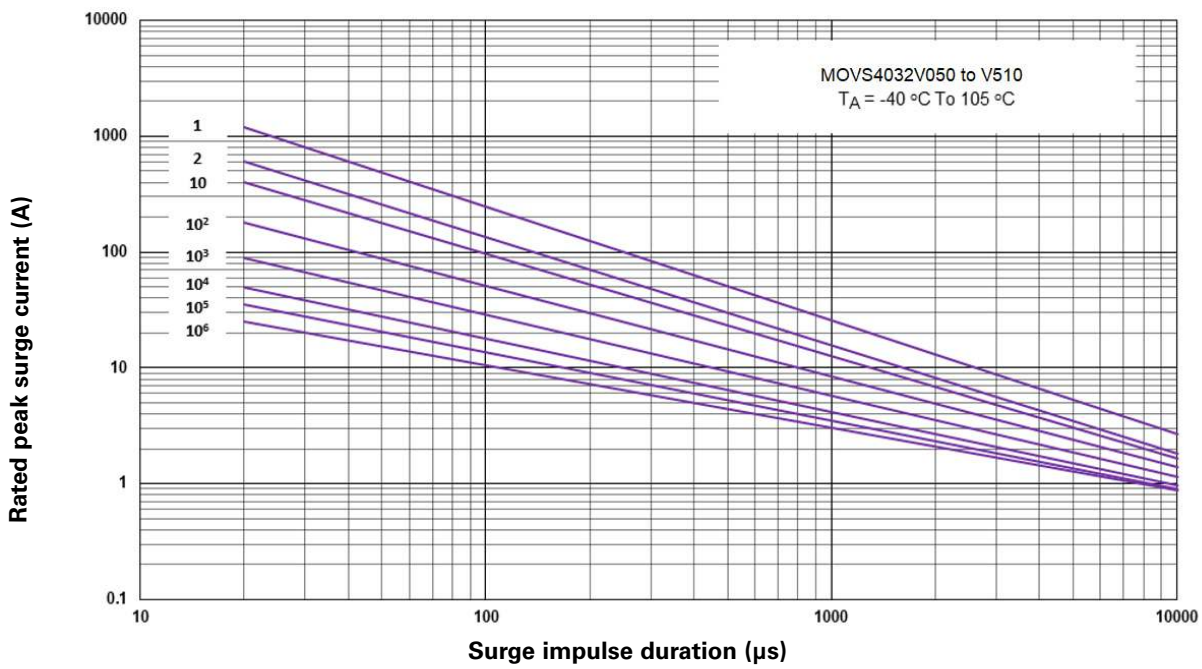
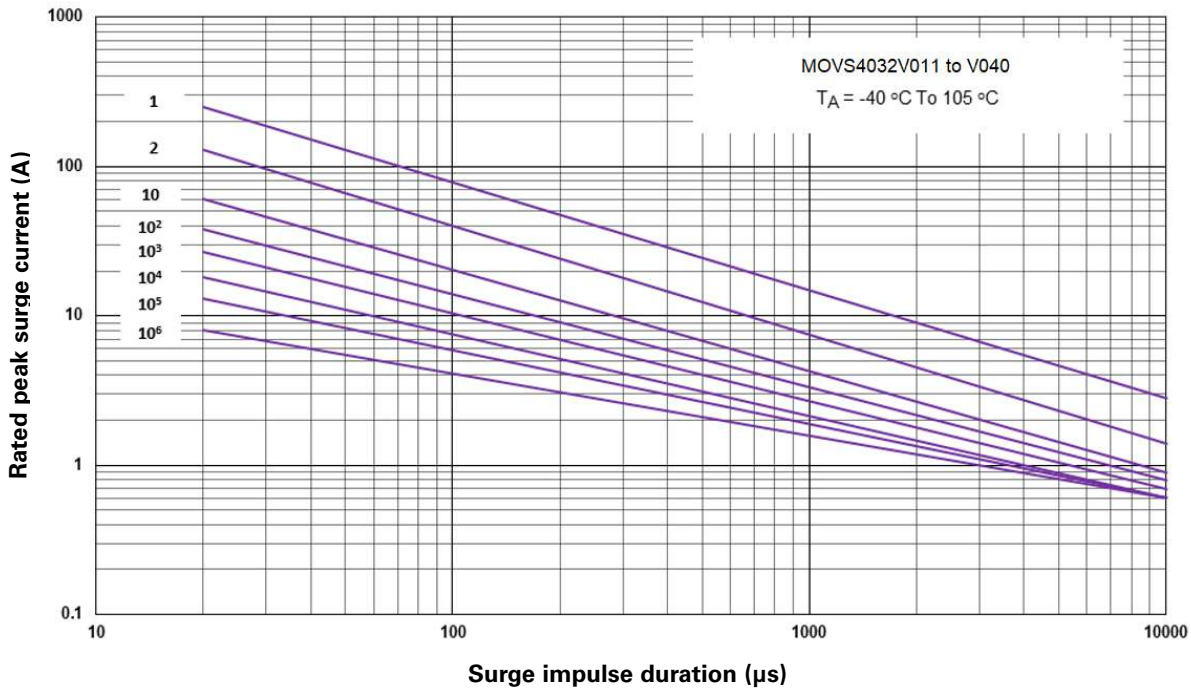

Solder reflow profile

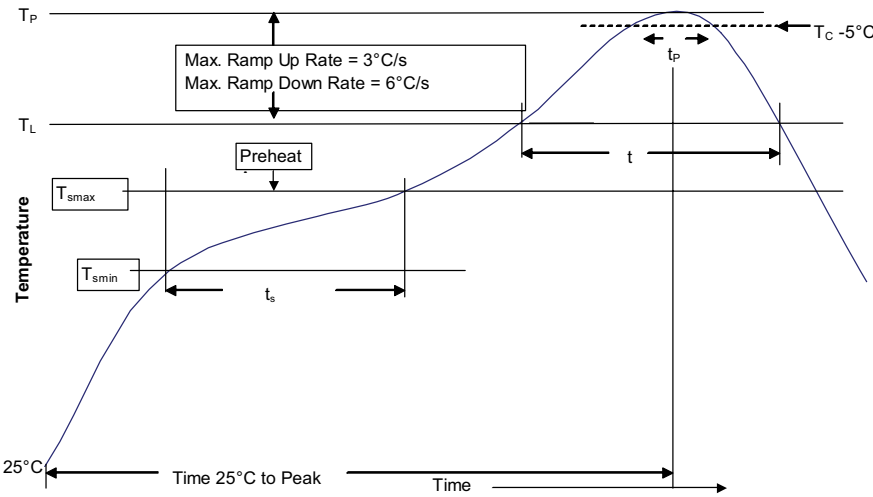

Table 1 - Standard SnPb solder (T_C)

Package thickness	Volume mm ³ <350	Volume mm ³ ≥350
<2.5 mm	235 °C	220 °C
≥2.5 mm	220 °C	220 °C

Table 2 - Lead (Pb) free solder (T_C)

Package thickness	Volume mm ³ <350	Volume mm ³ 350 - 2000	Volume mm ³ >2000
<1.6 mm	260 °C	260 °C	260 °C
1.6 – 2.5 mm	260 °C	250 °C	245 °C
>2.5 mm	250 °C	245 °C	245 °C

Reference J-STD-020

Profile feature	Standard SnPb solder	Lead (Pb) free solder
Preheat and soak		
• Temperature min. (T _{smin})	100 °C	150 °C
• Temperature max. (T _{smax})	150 °C	200 °C
• Time (T _{smin} to T _{smax}) (t _s)	60-120 seconds	60-120 seconds
Ramp up rate T _L to T _p	3 °C/ second max.	3 °C/ second max.
Liquidous temperature (T _L)	183 °C	217 °C
Time (t _L) maintained above T _L	60-150 seconds	60-150 seconds
Peak package body temperature (T _p)*	Table 1	Table 2
Time (t _p)* within 5 °C of the specified classification temperature (T _C)	20 seconds*	30 seconds*
Ramp-down rate (T _p to T _L)	6 °C/ second max.	6 °C/ second max.
Time 25 °C to peak temperature	6 minutes max.	8 minutes max.

* Tolerance for peak profile temperature (T_p) is defined as a supplier minimum and a user maximum.

Life Support Policy: Eaton does not authorize the use of any of its products for use in life support devices or systems without the express written approval of an officer of the Company. Life support systems are devices which support or sustain life, and whose failure to perform, when properly used in accordance with instructions for use provided in the labeling, can be reasonably expected to result in significant injury to the user.

Eaton reserves the right, without notice, to change design or construction of any products and to discontinue or limit distribution of any products. Eaton also reserves the right to change or update, without notice, any technical information contained in this bulletin.

Eaton
Electronics Division
1000 Eaton Boulevard
Cleveland, OH 44122
United States
Eaton.com/electronics

© 2022 Eaton
All Rights Reserved
Printed in USA
Publication No. ELX1004
August 2022

Eaton is a registered trademark.

All other trademarks are property of their respective owners.

Follow us on social media to get the latest product and support information.

