

Kirbii 868/915 MHz Chip Antenna

Part No. A10472

gigaNOVA®

Product Specification

1 Features

- Designed for ISM LoRa® Sigfox and Weightless-P applications
- Ceramic chip antenna
- Low profile design for use with no ground beneath the antenna
- High efficiency
- Light weight
- Intended for SMD mounting
- Supplied in tape on reel

2 Description

Kirbii is intended for use with all ISM LoRa®, Sigfox and Weightless-P applications in the 868 MHz and 915 MHz bands. The antenna uses a ground plane in order to radiate efficiently, but this ground plane must not extend underneath the antenna itself.

Copper tracks on the host PCB are required for the antenna to work properly. For correct integration, it is important to follow very closely the footprint drawings, preferably importing the electronic files (dxf or Gerber) into the PCB layout CAD.

3 Applications

- Remote monitoring
- Security cameras
- Electronic Shelf Labels
- Sensors
- LoRa® Gateway/Routers
- LoRa® Wireless Nodes

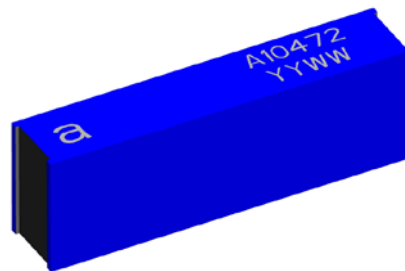

4 Part number

Kirbii: A10472



5 General data

Product name	Kirbii 868/915 MHz Chip Antenna
Part Number	A10472
Frequency	868-870 MHz 902-928 MHz
Polarization	Linear
Operating temperature	-40 °C to +140 °C
Environmental condition test	ISO16750-4 5.1.1.1/5.1.2.1/5.3.2
Impedance with matching	50 Ω
Weight	<0.1
Antenna type	SMD
Dimensions	10 x 3 x 2 [mm]
Footprint Size	24 x 10 [mm]

6 Electrical characteristics

	Typical performance	Conditions
Peak gain	0.7 dBi	Data given for the 868 – 870 MHz frequency range All data measured on Antenova's reference board part number A10472-U1
Average gain	-1.8 dBi	
Average efficiency	>65%	
Maximum Return Loss	-20dB	
Maximum VSWR	1.2:1	
Peak gain	1.6 dBi	Data given for the 902 – 928 MHz frequency range All data measured on Antenova's reference board part number A10472-U1
Average gain	-1.6 dBi	
Average efficiency	>70%	
Maximum Return Loss	-10 dB	
Maximum VSWR	2.1:1	

7 Electrical performance

7-1 Return Loss – 868 MHz

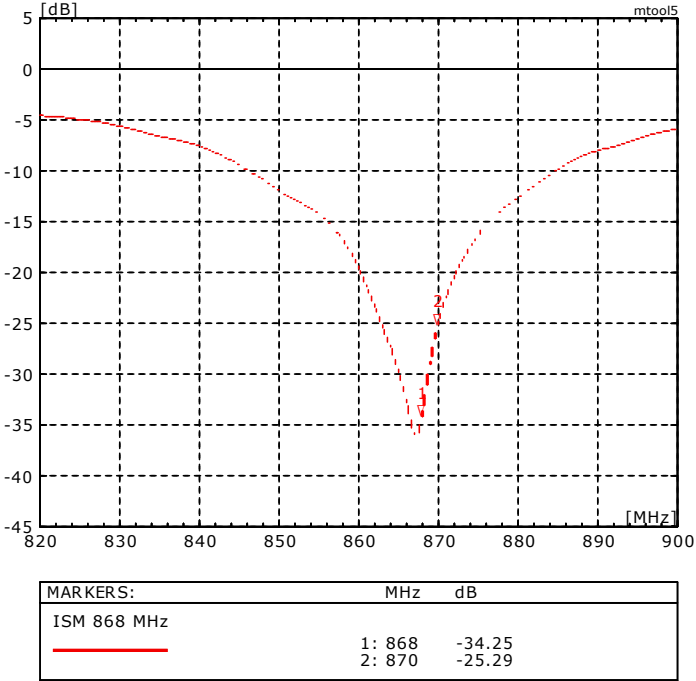

7-2 VSWR – 868 MHz

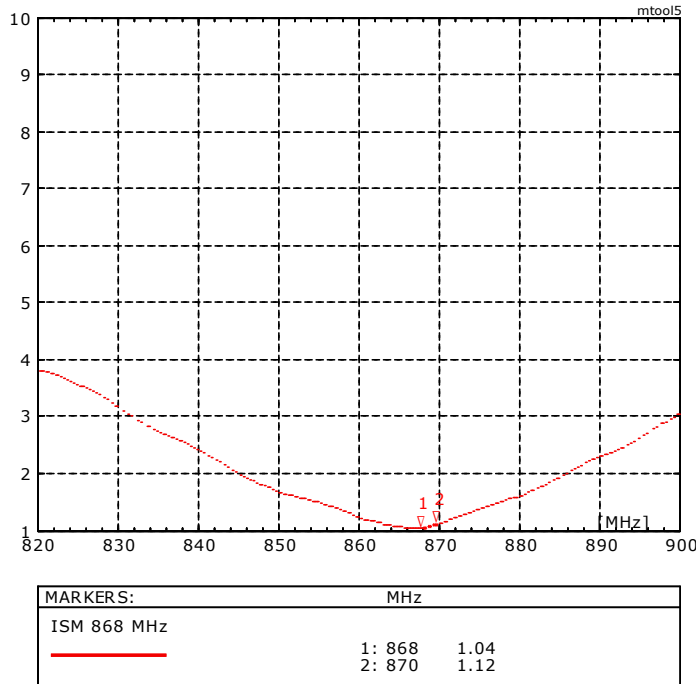

7-3 Return Loss – 902–928 MHz

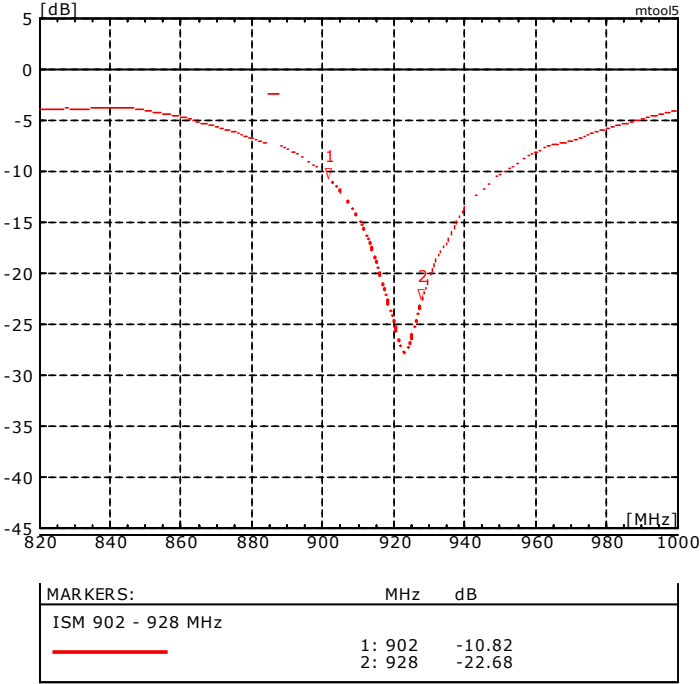

7-4 VSWR – 902-928 MHz

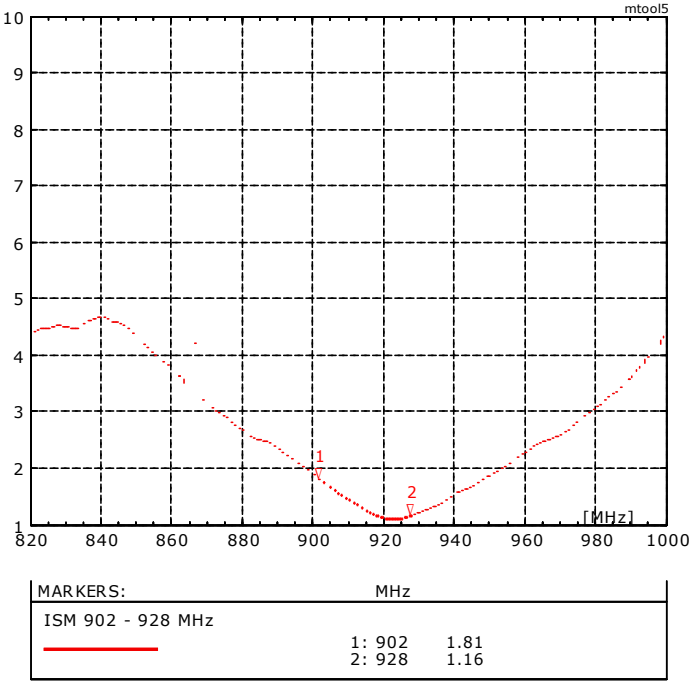

7-5 Antenna patterns – 68 - 870 MHz

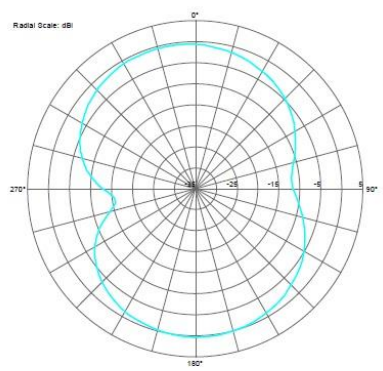
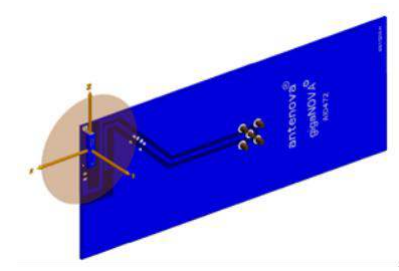
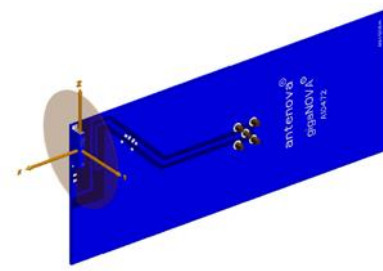
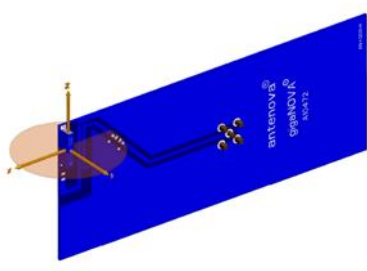
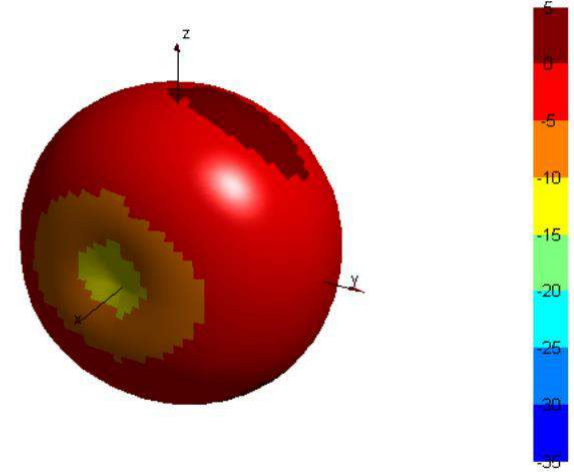
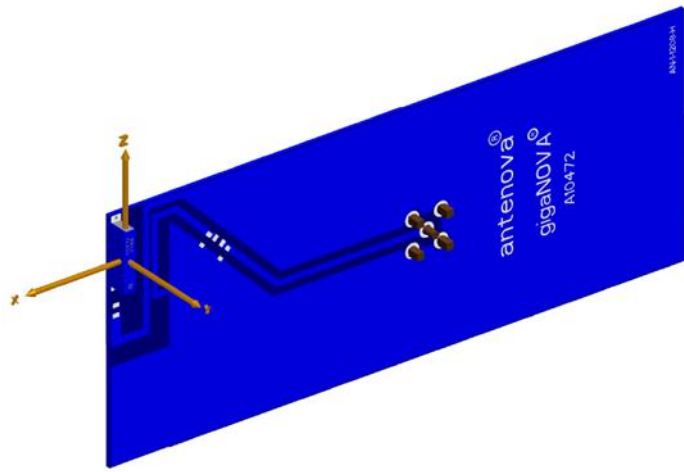

XY plane

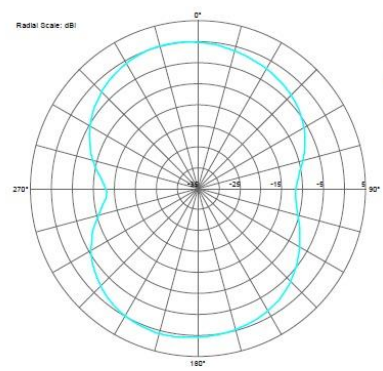

ZY plane

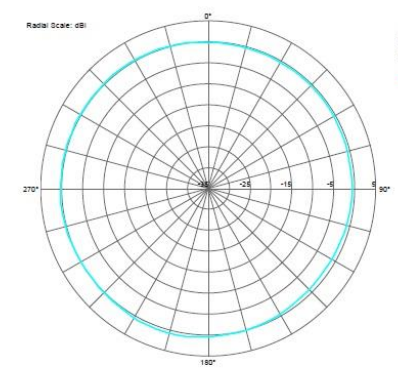

XZ plane

Patterns show combined polarisations
measured on reference board A10472-U1

Antennas for Wireless M2M Applications

7-6 Antenna patterns – 02 - 928 MHz

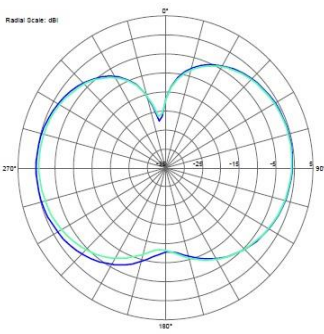
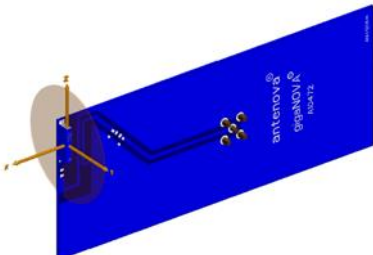
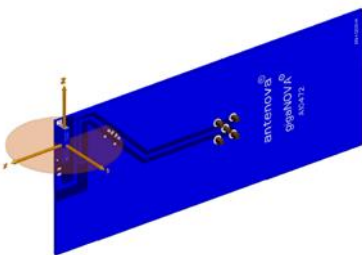
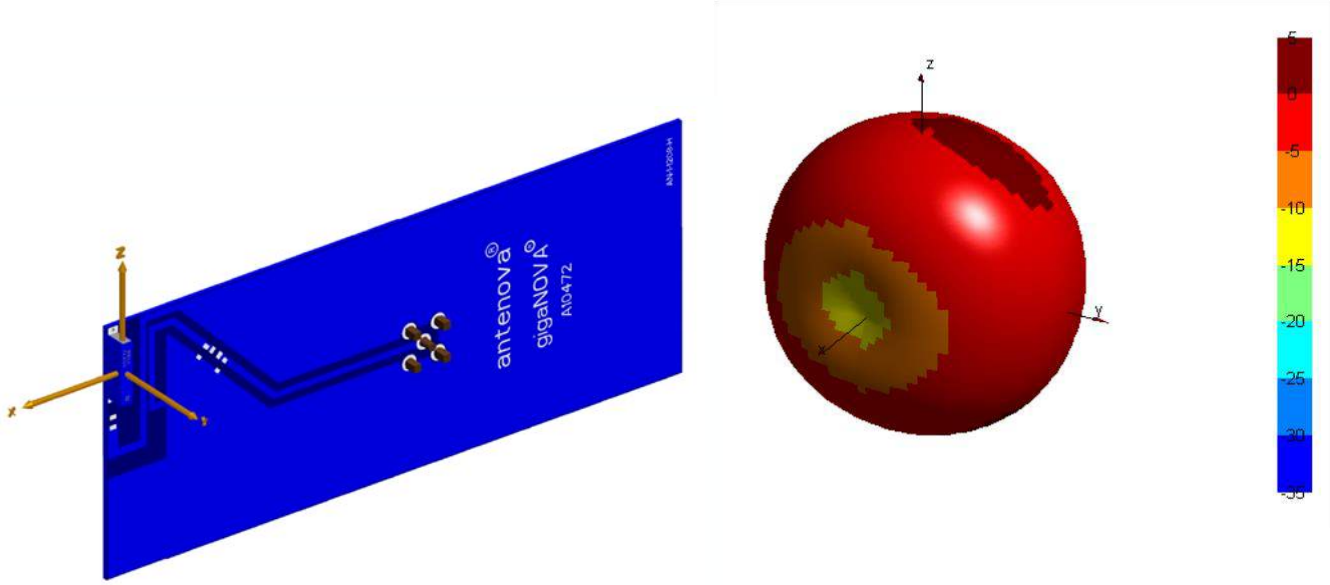

XY plane

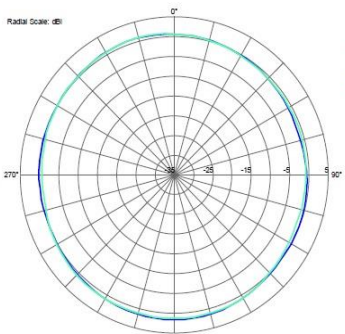

ZY plane

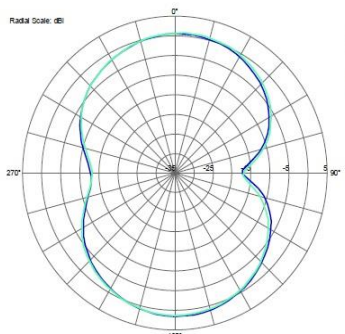

XZ plane

Patterns show combined polarisations
 measured on reference board A10472-U1

8 Antenna dimensions

Kirbii

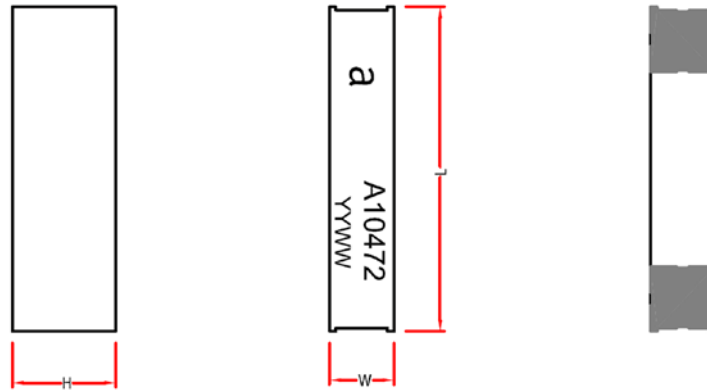

L	W	H
Length	Width	Height
10.0 ± 0.2	2.0 ± 0.2	3.2 ± 0.2

Dimensions in mm

9 Antenna footprint

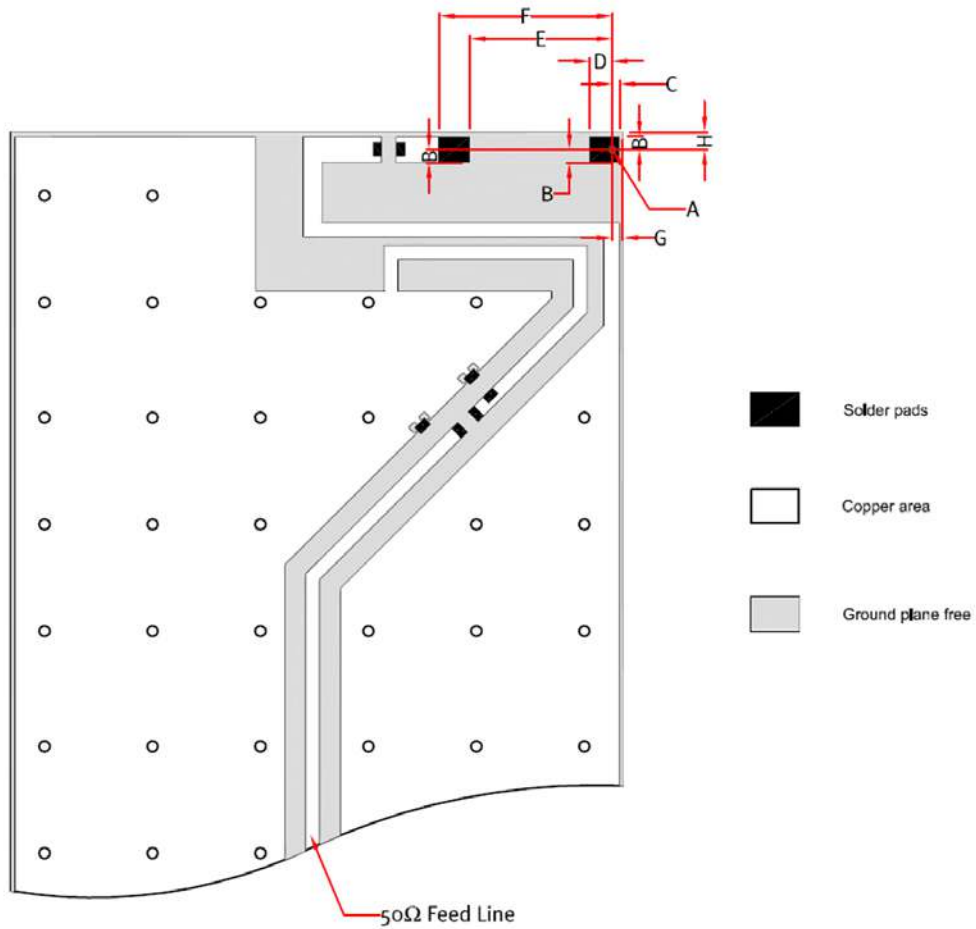

Kirbii (Part No: A10472)

CAD files of the antenna footprint are available to download from www.antenova-m2m.com.

A	B	C	D	E	F	G	H
0.50 ± 0.15	0.86 ± 0.15	0.50 ± 0.15	1.50 ± 0.15	9.30 ± 0.15	11.30 ± 0.15	0.70 ± 0.15	1.13 ± 0.15

Dimensions in mm

10 Electrical interface

10-1 Transmission lines

- All transmission lines should be designed to have a characteristic impedance of 50 Ω
- The length of the transmission lines should be kept to a minimum
- Any other parts of the RF system like transceivers, power amplifiers, etc, should also be designed to have an impedance of 50 Ω

Once the material for the PCB has been chosen (PCB thickness and dielectric constant), a coplanar transmission line can easily be designed using any of the commercial software packages for transmission line design. For the chosen PCB thickness, copper thickness and substrate dielectric constant, the program will calculate the appropriate transmission line width and gaps on either side of the track so the characteristic impedance of the coplanar transmission line is 50 Ω .

10-2 Matching circuit

The antenna requires an impedance matching circuit that must be optimized for each customer's product. The matching circuit will typically require three matching components and up to four components depending on the impedance of the antenna when situation on the device. It is recommended that the pad layout shown in Sect. 9 above should be designed into the device so the correct circuit can be installed:

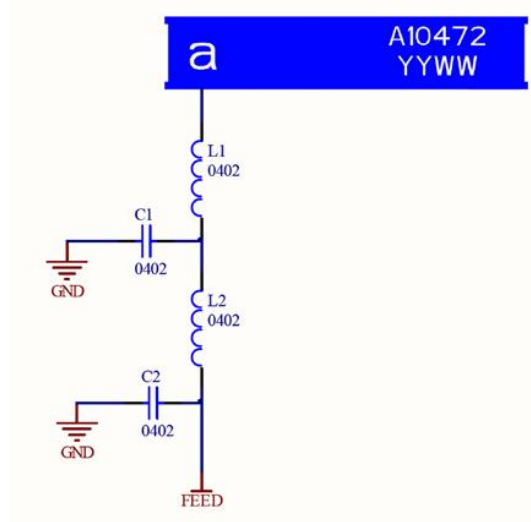

Note: The component values for the matching circuit will vary depending on the size of the PCB and surrounding components. The impedance of the antenna should be measured before selecting suitable matching components. Antenova M2M offers this service on request.

Contact sales@antenova-m2m.com for further information.

10-3 Reference boards

The reference boards have been designed for evaluation purposes of Kirbii 868/915 MHz SMD antenna and they include a SMA female connector

Kirbii A10472-U1

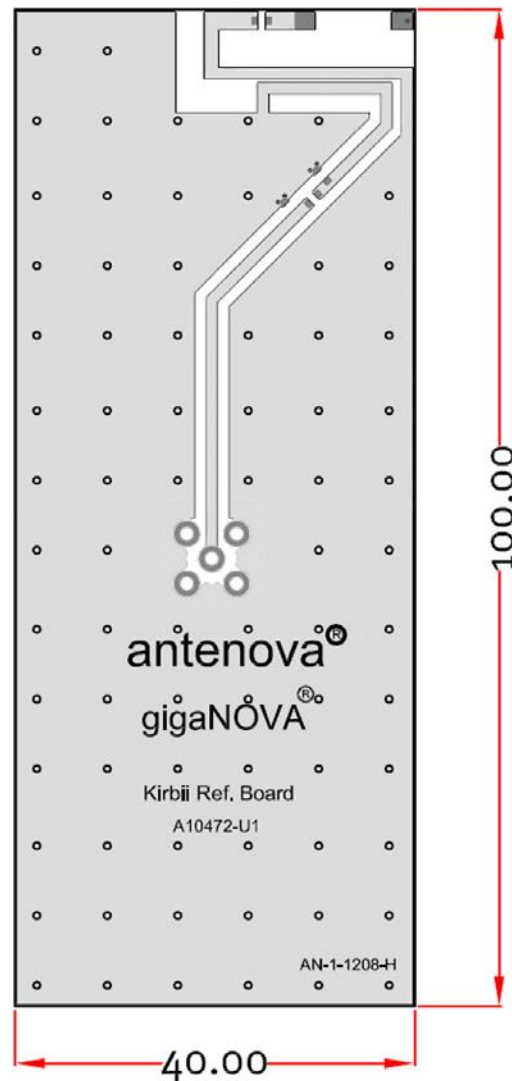

Dimensions in mm

To order a reference board contact sales@antenova-m2m.com

11 Soldering

This antenna is suitable for lead free soldering.

The reflow profile should be adjusted to suit the device, oven and solder paste, while observing the following conditions:

- The maximum temperature should not exceed 240 °C
- However for lead free soldering, a maximum temperature of 255 °C for no more than 20 seconds is permitted.
- The antenna should not be exposed to temperatures exceeding 120 °C more than 3 times during the soldering process.

12 Hazardous material regulation conformance

The antenna has been tested to conform to RoHS requirements. A certificate of conformance is available from Antenova M2M's website.

13 Packaging

Kirbii will be supplied in tape on reel and further packaging details to follow.

13-1 Optimal storage conditions for packaged reels

Temperature	-10°C to 40°C
Humidity	Less than 75% RH
Shelf Life	18 Months
Storage place	Away from corrosive gas and direct sunlight
Packaging	Reels should be stored in unopened sealed manufacturer's plastic packaging.

Note: Storage of open reels of antennas is not recommended due to possible oxidization of pads on antennas. If short term storage is necessary, then it is highly recommended that the bag containing the antenna reel is re-sealed and stored in like storage conditions as in above table.

13-2 Bag properties

Reels are supplied in protective plastic packaging



www.antenova-m2m.com

Corporate Headquarters

Antenova Ltd.
2nd Floor, Titan Court
3 Bishop Square
Hatfield
Herts
AL10 9NA

Tel: +44 1223 810600
Email: sales@antenova-m2m.com

North America Headquarters

Antenova Ltd.
100 Brush Creek Road, Suite 103
Santa Rosa,
California 95404
USA

Tel: +1 707 890 5202
Email: sales@antenova-m2m.com

Asia Headquarters

Antenova Asia Ltd.
4F, No. 324, Sec. 1, Nei-Hu Road
Nei-Hu District
Taipei 11493
Taiwan, ROC

Tel: +886 (0) 2 8797 8630
Fax: +886 (0) 2 8797 6890
Email: sales@antenova-m2m.com

Copyright® Antenova Ltd. All Rights Reserved. Antenova®, Antenova M2M®, gigaNOVA®, the Antenova product family names, and the Antenova and Antenova M2M logos are trademarks and/or registered trademarks of Antenova Ltd. Any other names and/or trademarks belong to their respective companies.

The materials provided herein are believed to be reliable and correct at the time of print. Antenova does not warrant the accuracy or completeness of the information, text, graphics or other items contained within these information. Antenova further assumes no responsibility for the use of this information, and all such information shall be entirely at the user's risk.



Certificate No: 4598

Antennas for Wireless M2M Applications