

# Thin-Film RF/Microwave Filters

## 2816 High Performance Low Pass 20W

### General Information

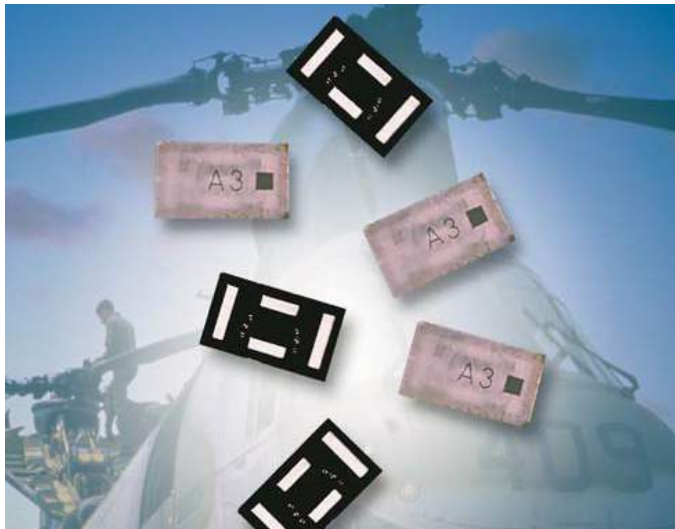

#### HOW TO ORDER

**LP**   **2816**   **A**   **XXXX**   **S**   **N**   **TR**  
 Series   Size   Type   Frequency (MHz)   Sub-Type   Termination   Taped & Reeled



#### FINAL QUALITY INSPECTION

Finished parts are 100% tested for electrical parameters and visual/mechanical characteristics. Each production lot is evaluated on a sample basis for:

- Static Humidity: 85°C, 85% RH, 160 hours
- Endurance: 125°C, I<sub>R</sub>, 4 hours

#### TERMINATION

Nickel/ Lead free Solder coating (Sn100) compatible with automatic soldering technologies: reflow, wave soldering, vapor phase and manual.

#### POWER RATING

20W Continuous

#### ITF TECHNOLOGY

The ITF LGA Filter is based on thin-film multilayer technology. The technology provides a miniature part with excellent high frequency performance and rugged construction for reliable automatic assembly.

The ITF Filter is offered in a variety of frequency bands compatible with various types of high frequency wireless systems.

#### FEATURES

- Small size: 7x4x1.2 (LxWxT)
- Frequency: 500-2500MHz
- Steep attenuation
- Characteristic impedance: 50Ω
- Operating/Storage temp: -40°C – +85°C
- Low profile
- Rugged construction
- Taped and reeled
- RoHS compliant

#### APPLICATIONS

- Mobile communications
- Satellite TV receivers
- GPS
- Vehicle location systems
- Wireless LAN's

#### DIMENSIONS (BOTTOM VIEW): mm (inches)

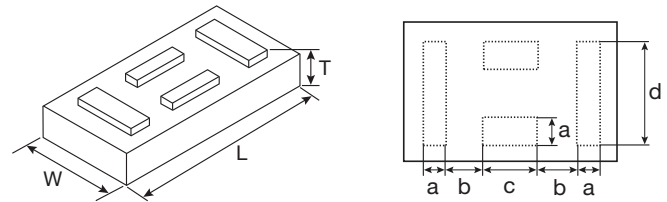

#### TERMINALS (TOP VIEW)

<b>L</b>	7.00±0.30 (0.276±0.012)	<b>a</b>	0.60±0.15 (0.024±0.006)
<b>W</b>	4.00±0.20 (0.157±0.008)	<b>b</b>	1.40±0.15 (0.055±0.006)
<b>T</b>	1.2 max (0.047 max)	<b>c</b>	2.00±0.15 (0.079±0.006)
		<b>d</b>	3.00±0.15 (0.118±0.006)

#### ELECTRICAL SPECIFICATIONS TABLE

Frequency [MHz]	Insertion Loss [dB]	Return Loss [dB]	Rejection [dB]	Rejection [dB]	Rejection [dB]
400	-0.85	-18	-35 dB @ 500 - 1000 MHz	-45 dB @ 1001 - 3000 MHz	----
500	-0.9	-18	-35 dB @ 1000 MHz	-40 dB @ 1500 - 2500 MHz	----
512	-0.85	-18	-40 dB @ 720 MHz	-35 dB @ 1024 MHz	-50dB @ 1500 - 2500 MHz
520	-0.95	-18	-35 dB @ 1040 MHz	-40 dB @ 1500 - 2500 MHz	----
570	-0.7	-18	-35 dB @ 1140 MHz	-40 dB @ 1500 - 2500 MHz	----
600	-0.7	-18	-35 dB @ 1200 MHz	-40 dB @ 1500 - 2500 MHz	----
680	-0.7	-23	-36 dB @ 950 MHz	-40 dB @ 1360 - 2500 MHz	----
1300	-0.85	-15	-40 dB @ 850 MHz	-40 dB @ 2000 - 7000 MHz	-30 dB @ 7.0 - 10.0 GHz
1400	-0.75	-15	-35 dB @ 1960 MHz	-40 dB @ 2100 - 6000 MHz	-30 dB @ 6.0 - 9.0 GHz
1600	-0.8	-20	-45 dB @ 2240 MHz	-40 dB @ 2240 - 7500 MHz	-35 dB @ 7.5 - 10 GHz
1700	-0.52	-14	-30 dB @ 2380 MHz	-40 dB @ 2500 - 7000 MHz	-30 dB @ 7.0 - 10 GHz
1800	-0.75	-20	-20 dB @ 2520 MHz	-40 dB @ 2800 - 8500 MHz	-35 dB @ 8.5 - 10 GHz
1900	-0.8	-23	-35 dB @ 2660 MHz	-40 dB @ 3000 - 10000 MHz	-40 dB @ 720 MHz
2500	-0.8	-15	-35 dB @ 3500 MHz	-45 dB @ 5400 - 7500 MHz	-35dB @ 10 GHz

Click on frequency to see full specifications

# Thin-Film RF/Microwave Filters

## 2816 High Performance Low Pass 15W

### LP2816A0400SNTR – LGA Termination



#### TYPICAL ELECTRICAL PERFORMANCE

Parameter	Value	Unit	Notes
Fc	400	MHz	
Insertion Loss @500 MHz	-0.85	dB	
R Loss @500MHz	-18	dB	
Rejection @1000MHz	-35	dB	
Rejection @ 1500 - 2500 MHz	-45	dB	
Power Handling	15	W	RF Continuous
Impedance	50	Ohm	
Operating Temp.	-40 to +85	°C	
Size	7x4x1.2mm		

[Click here to return to main table](#)

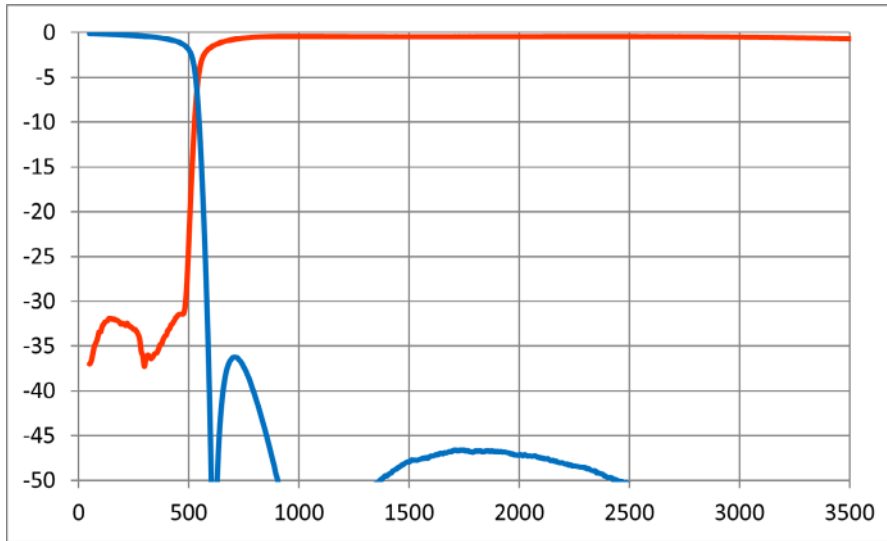

#### RECOMMENDED PAD LAYOUT

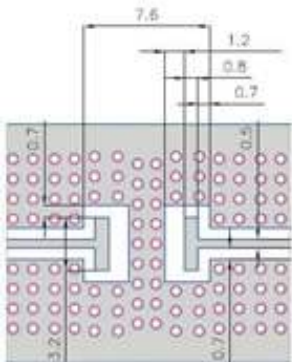

#### ORIENTATION MARKING CODE

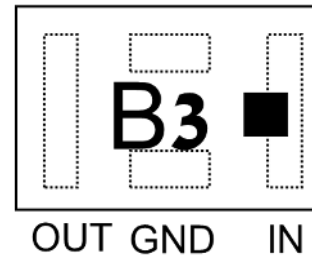

# Thin-Film RF/Microwave Filters

## 2816 High Performance Low Pass 20W

### LP2816A0500SNTR – LGA Termination



#### TYPICAL ELECTRICAL PERFORMANCE

Parameter	Value	Unit	Notes
Fc	500	MHz	
Insertion Loss @500 MHz	-0.9	dB	Max.
R Loss @500MHz	-18	dB	
Rejection @1000MHz	-35	dB	Min.
Rejection @ 1500 - 2500 MHz	-40	dB	Min.
Power Handling	20	W	RF Continuous
Impedance	50	Ohm	
Operating Temp.	-40 to +85	°C	
Size	7x4x1.2mm		

[Click here to return to main table](#)

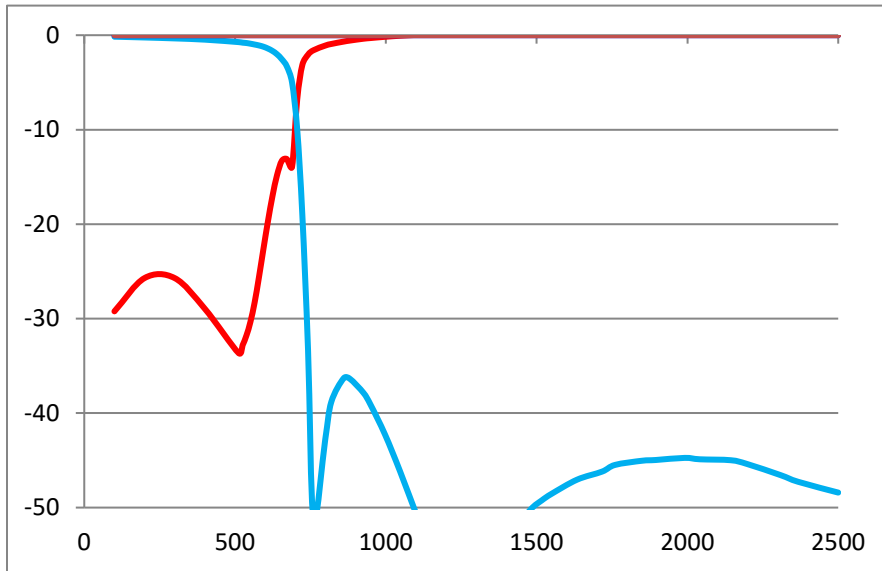

#### RECOMMENDED PAD LAYOUT

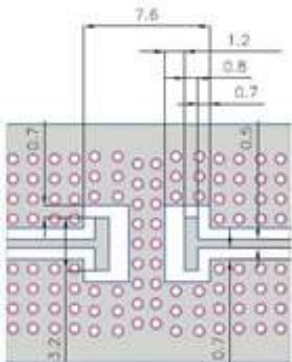

#### ORIENTATION MARKING CODE

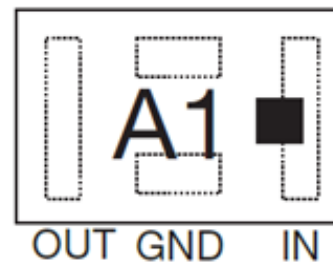

# Thin-Film RF/Microwave Filters

## 2816 High Performance Low Pass 20W

### LP2816A0512SNTR – LGA Termination



#### TYPICAL ELECTRICAL PERFORMANCE

Parameter	Value	Unit	Notes
Fc	512	MHz	
Insertion Loss @512 MHz	-0.85	dB	Max.
R Loss @512MHz	-18	dB	
Rejection @ 720 MHz	-40	dB	Min.
Rejection @1024 MHz	-35	dB	Min.
Rejection @ 1500 - 2500 MHz	-50	dB	Min.
Power Handling	20	W	RF Continuous
Impedance	50	Ohm	
Operating Temp.	-40 to +85	°C	
Size	7x4x1.2mm		

[Click here to return to main table](#)

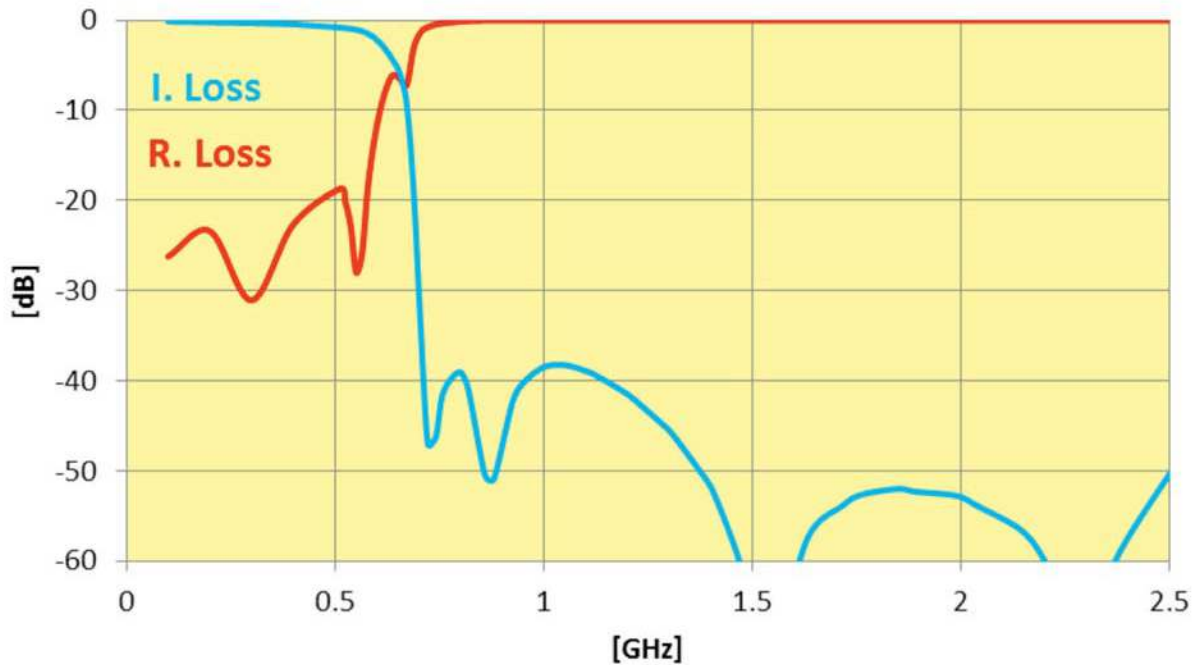

#### RECOMMENDED PAD LAYOUT

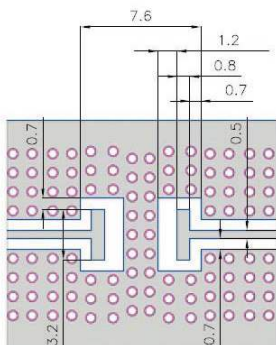

#### ORIENTATION MARKING CODE



# Thin-Film RF/Microwave Filters

## 2816 High Performance Low Pass 20W

### LP2816A0520SNTR – LGA Termination



#### TYPICAL ELECTRICAL PERFORMANCE

Parameter	Value	Unit	Notes
Fc	520	MHz	
Insertion Loss @520 MHz	-0.95	dB	Max.
R Loss @ 520MHz	-18	dB	
Rejection @1040 MHz	-35	dB	Min.
Rejection @ 1500 - 2500 MHz	-40	dB	Min.
Power Handling	20	W	RF Continuous
Impedance	50	Ohm	
Operating Temp.	-40 to +85	°C	
Operating Temp.	-40 to +85	°C	
Size	7x4x1.2mm		

[Click here to return to main table](#)

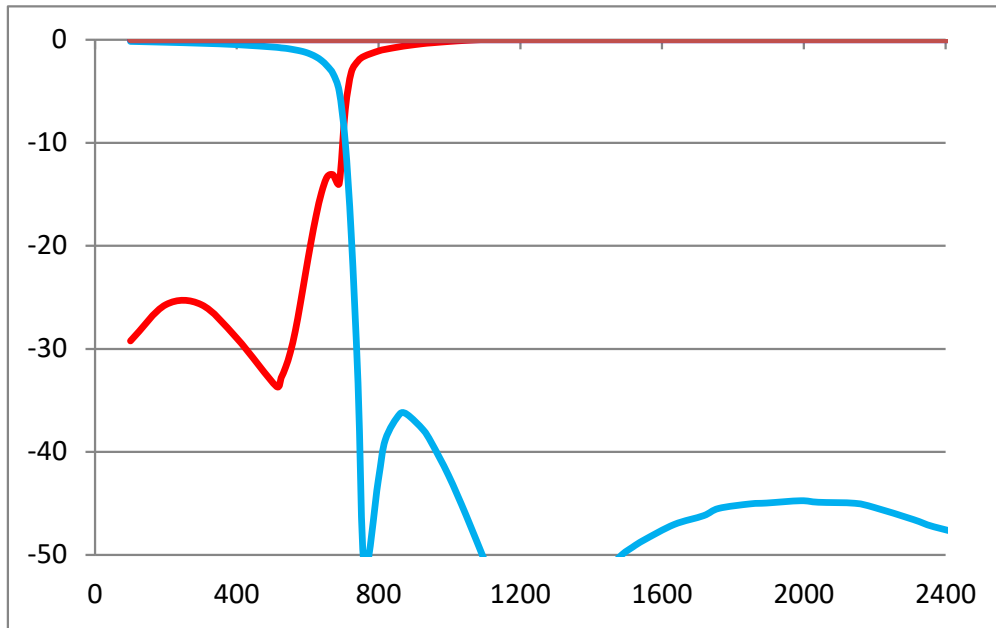

#### RECOMMENDED PAD LAYOUT

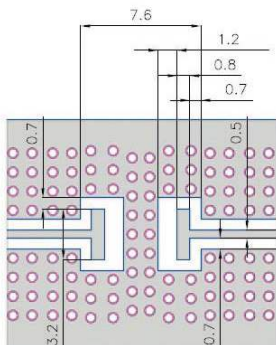

#### ORIENTATION MARKING CODE



# Thin-Film RF/Microwave Filters

## 2816 High Performance Low Pass 20W

### LP2816A0570SNTR – LGA Termination



#### TYPICAL ELECTRICAL PERFORMANCE

Parameter	Value	Unit	Notes
Fc	570	MHz	
Insertion Loss @570MHz	-0.85	dB	Max.
R Loss @570MHz	-18	dB	
Rejection @1140 MHz	-35	dB	Min.
Rejection @ 1500 - 2500 MHz	-40	dB	Min.
Power Handling	20	W	RF Continuous
Impedance	50	Ohm	
Operating Temp.	-40 to +85	°C	
Size	7x4x1.2mm		

[Click here to return to main table](#)

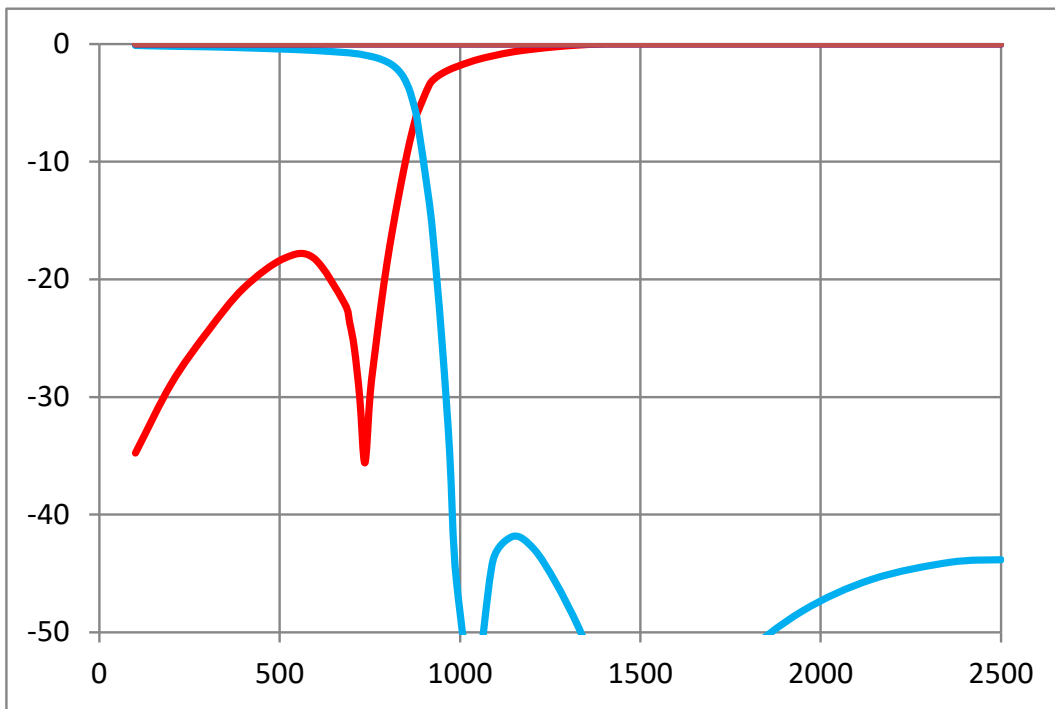

#### RECOMMENDED PAD LAYOUT

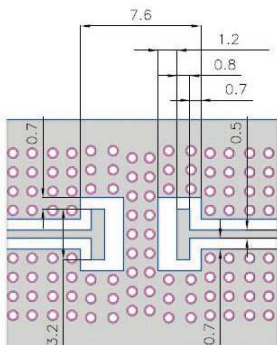

#### ORIENTATION MARKING CODE



# Thin-Film RF/Microwave Filters

## 2816 High Performance Low Pass 20W

### LP2816A0600SNTR – LGA Termination



#### TYPICAL ELECTRICAL PERFORMANCE

Parameter	Value	Unit	Notes
Fc	600	MHz	
Insertion Loss @600MHz	-0.85	dB	Max.
R Loss @ 600 MHz	-18	dB	
Rejection @1200 MHz	-35	dB	Min.
Rejection @ 1500 - 2500 MHz	-40	dB	Min.
Power Handling	20	W	RF Continuous
Impedance	50	Ohm	
Operating Temp.	-40 to +85	°C	
Size	7x4x1.2mm		

[Click here to return to main table](#)

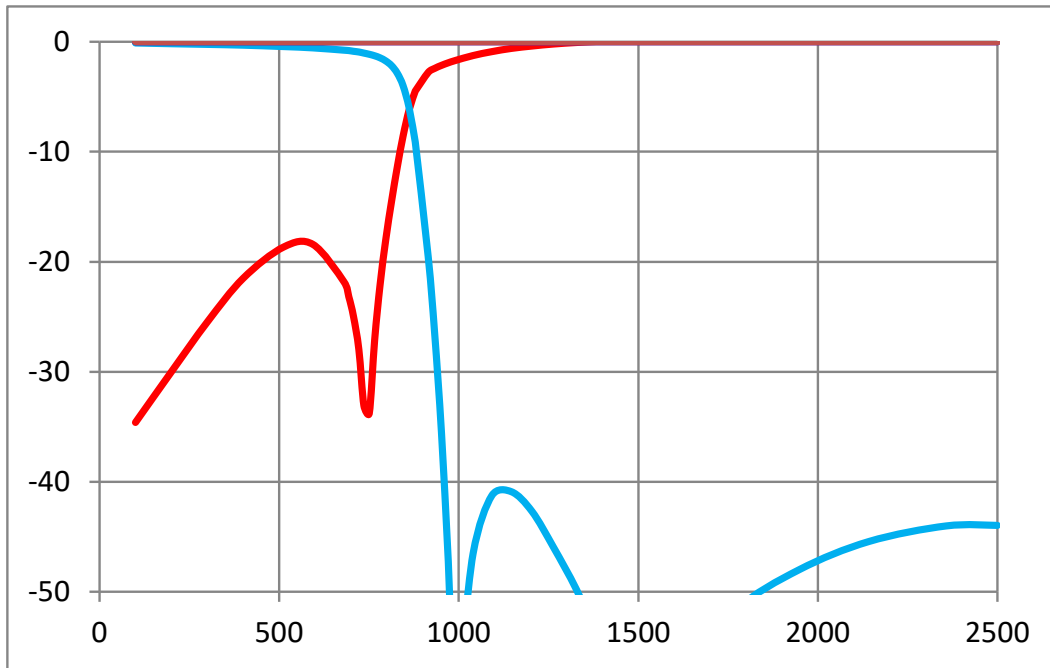

#### RECOMMENDED PAD LAYOUT

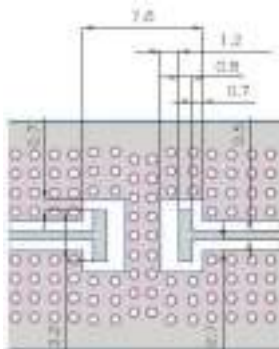

#### ORIENTATION MARKING CODE



# Thin-Film RF/Microwave Filters

## 2816 High Performance Low Pass 20W

### LP2816A0680SNTR – LGA Termination



#### TYPICAL ELECTRICAL PERFORMANCE

Parameter	Value	Unit	Notes
Fc	680	MHz	
Rejection @950MHz	-36	dB	Min.
Rejection 1.36GHz-2.5GHz	-40	dB	Min.
Insertion Loss @680MHz	-0.7	dB	Max.
R Loss @680MHz	-23	dB	
Power Handling	20	W	RF Continuous
Impedance	50	Ohm	
Operating Temp.	-40 to +85	°C	
Size	7x4x1.2mm		

[Click here to return to main table](#)

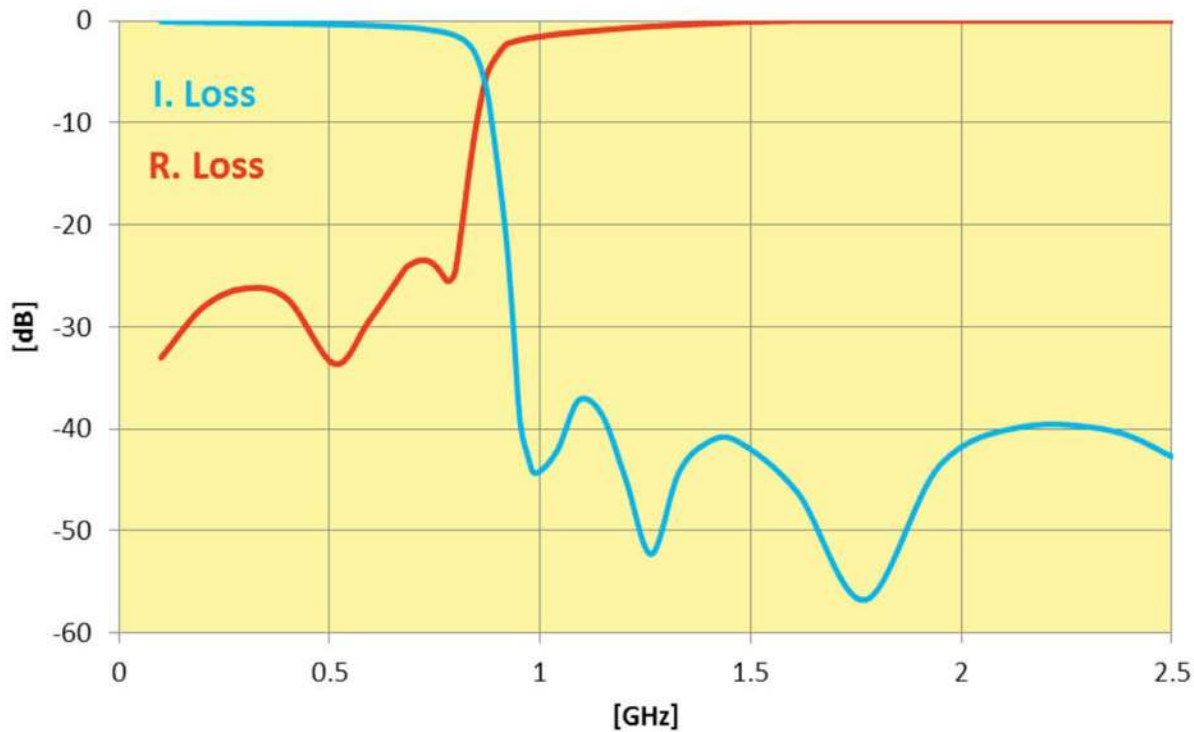

#### RECOMMENDED PAD LAYOUT

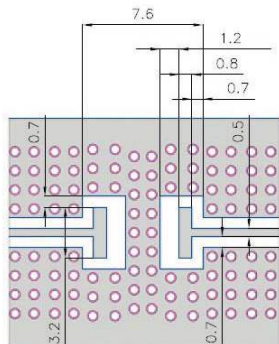

#### ORIENTATION MARKING CODE

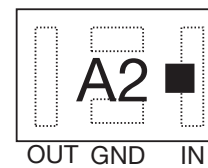

The Important Information/Disclaimer is incorporated in the catalog where these specifications came from or available online at [www.kyocera-avx.com/disclaimer/](http://www.kyocera-avx.com/disclaimer/) by reference and should be reviewed in full before placing any order.

TDS-RFM-0049 | Rev 1

– RF MICROWAVE PRODUCTS –



# Thin-Film RF/Microwave Filters

## 2816 High Performance Low Pass 20W

### LP2816A1300SNTR – LGA Termination



#### TYPICAL ELECTRICAL PERFORMANCE

Parameter	Value	Unit	Notes
Fc	1300	MHz	
Rejection @1.82GHz	-40	dB	Min.
Rejection 2GHz-7GHz	-40	dB	Min.
Rejection 7GHz-10GHz	-30	dB	Min.
Insertion Loss @1300MHz	-0.85	dB	Max.
Return Loss @1300MHz	-15	dB	Typ.
Power Handling	20	W	RF Continuous
Impedance	50	Ohm	
Operating Temp.	-40 to +85	°C	
Size	7x4x1.2mm		

[Click here to return to main table](#)

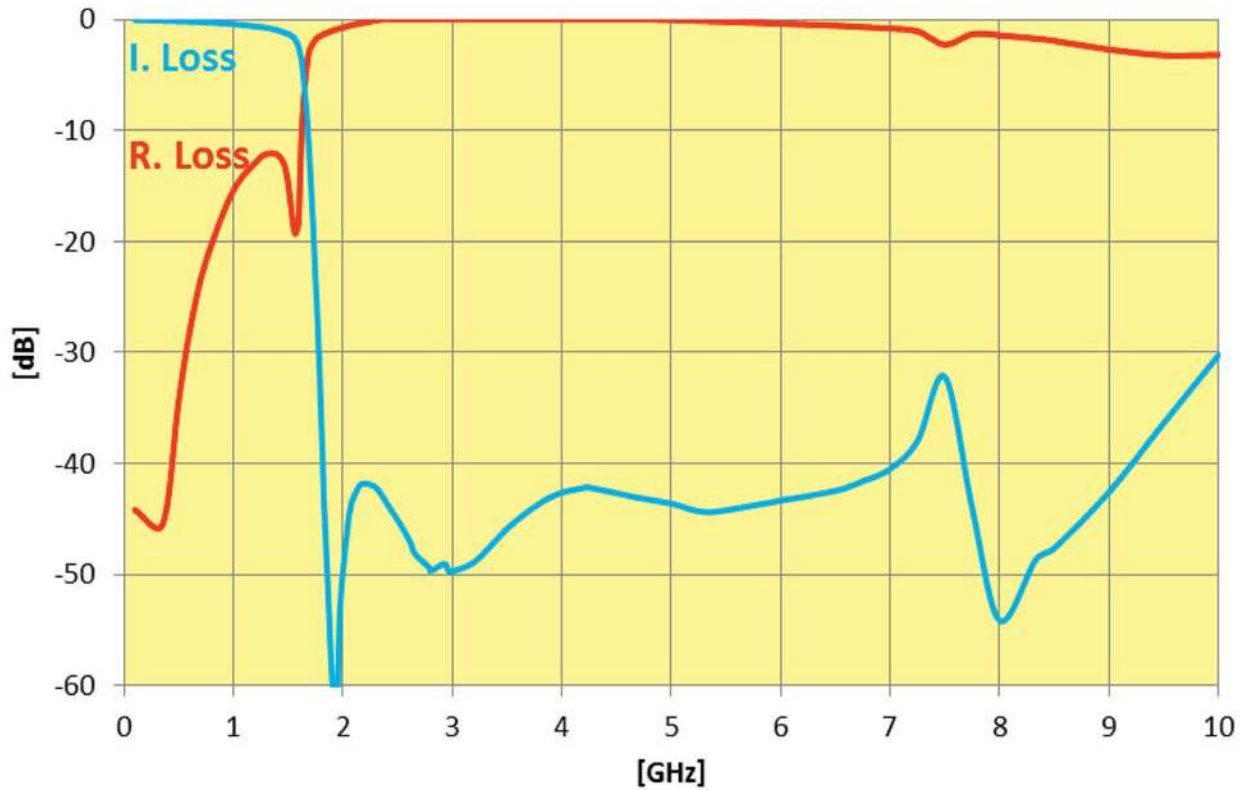

#### RECOMMENDED PAD LAYOUT

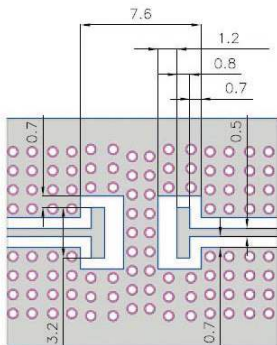

#### ORIENTATION MARKING CODE



# Thin-Film RF/Microwave Filters

## 2816 High Performance Low Pass 20W

### LP2816A1400SNTR – LGA Termination



#### TYPICAL ELECTRICAL PERFORMANCE

Parameter	Value	Unit	Notes
Fc	1400	MHz	
Rejection @1960MHz	-35	dB	Min.
Rejection 2.1GHz-6GHz	-40	dB	Min.
Rejection 6GHz-9GHz	-30	dB	Min.
Insertion Loss @1400MHz	-0.75	dB	Max.
R Loss @1400MHz	-15	dB	
Power Handling	20	W	RF Continuous
Impedance	50	Ohm	
Operating Temp.	-40 to +85	°C	
Size	7x4x1.2mm		

[Click here to return to main table](#)

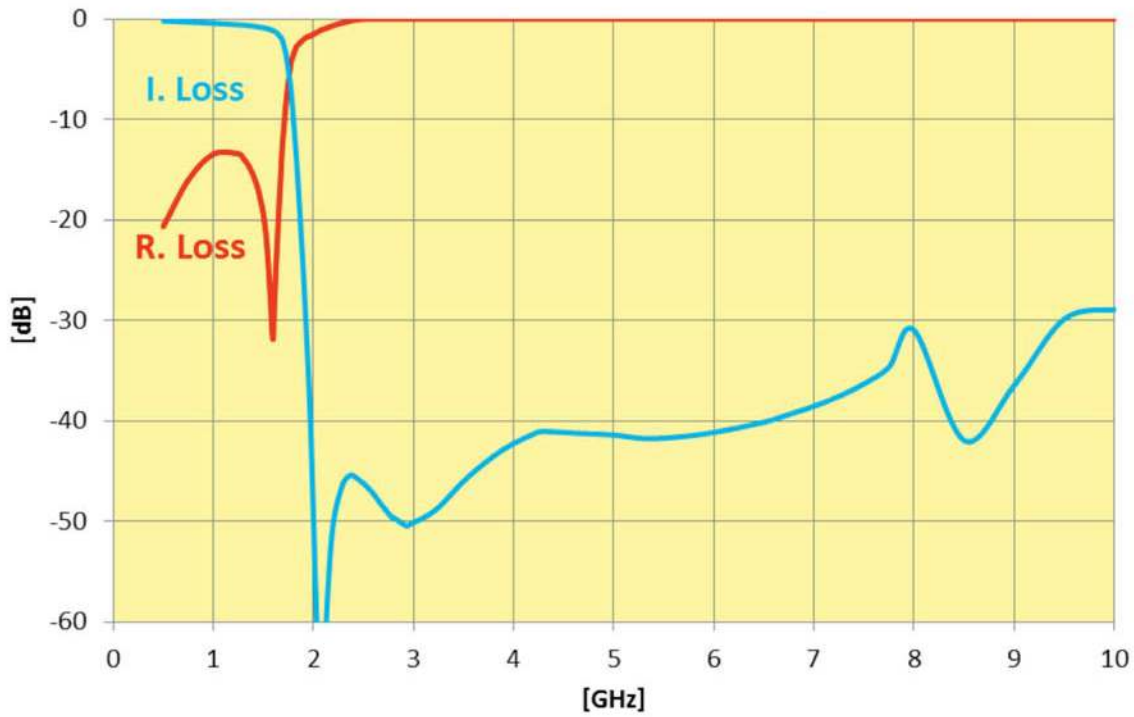

#### RECOMMENDED PAD LAYOUT

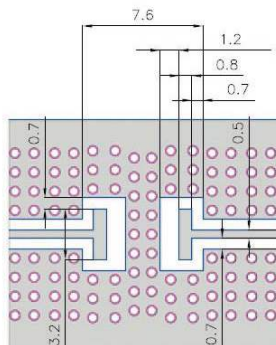

#### ORIENTATION MARKING CODE



# Thin-Film RF/Microwave Filters

## 2816 High Performance Low Pass 20W

### LP2816A1600SNTR – LGA Termination



#### TYPICAL ELECTRICAL PERFORMANCE

Parameter	Value	Unit	Notes
Fc	1600	MHz	
Rejection @2.24GHz	-45	dB	Min.
Rejection 2.24GHz-7.5GHz	-40	dB	Min.
Rejection 7.5GHz-10GHz	-35	dB	Min.
Insertion Loss @1600MHz	-0.8	dB	Max.
Return Loss @1600MHz	-20	dB	Typ.
Power Handling	20	W	RF Continuous
Impedance	50	Ohm	
Operating Temp.	-40 to +85	°C	
Size	7x4x1.2mm		

[Click here to return to main table](#)

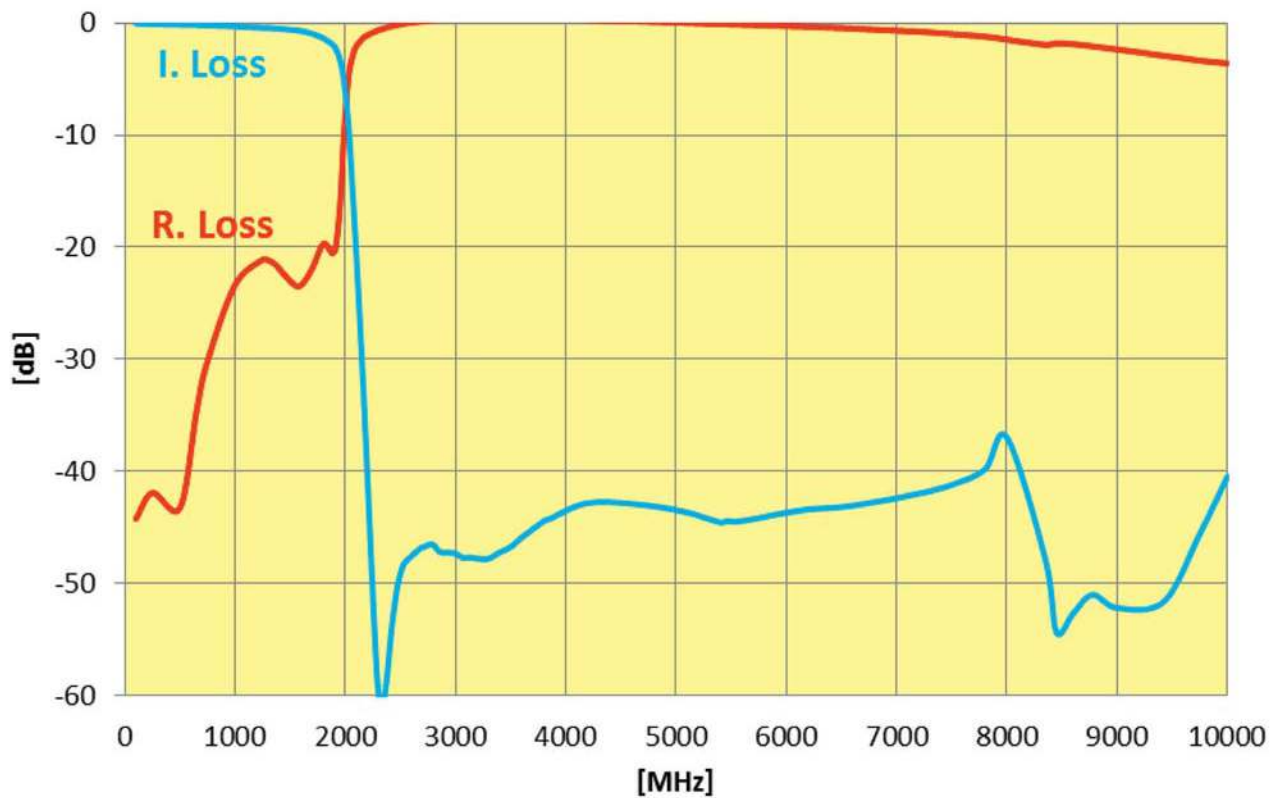

#### RECOMMENDED PAD LAYOUT

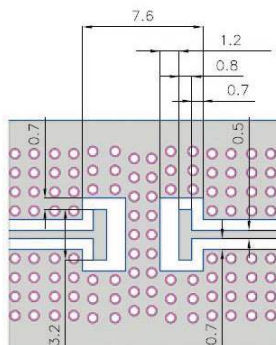

#### ORIENTATION MARKING CODE



# Thin-Film RF/Microwave Filters

## 2816 High Performance Low Pass 20W

### LP2816A1700SNTR – LGA Termination



#### TYPICAL ELECTRICAL PERFORMANCE

Parameter	Value	Unit	Notes
Fc	1700	MHz	
Rejection @2.38GHz	-30	dB	Min.
Rejection 2.5GHz-7GHz	-45	dB	Min.
Rejection 7GHz-10GHz	-30	dB	Min.
Insertion Loss @1700MHz	-0.85	dB	Max.
Return Loss @1700MHz	-14	dB	Typ.
Power Handling	20	W	RF Continuous
Impedance	50	Ohm	
Operating Temp.	-40 to +85	°C	
Size	7x4x1.2mm		

[Click here to return to main table](#)

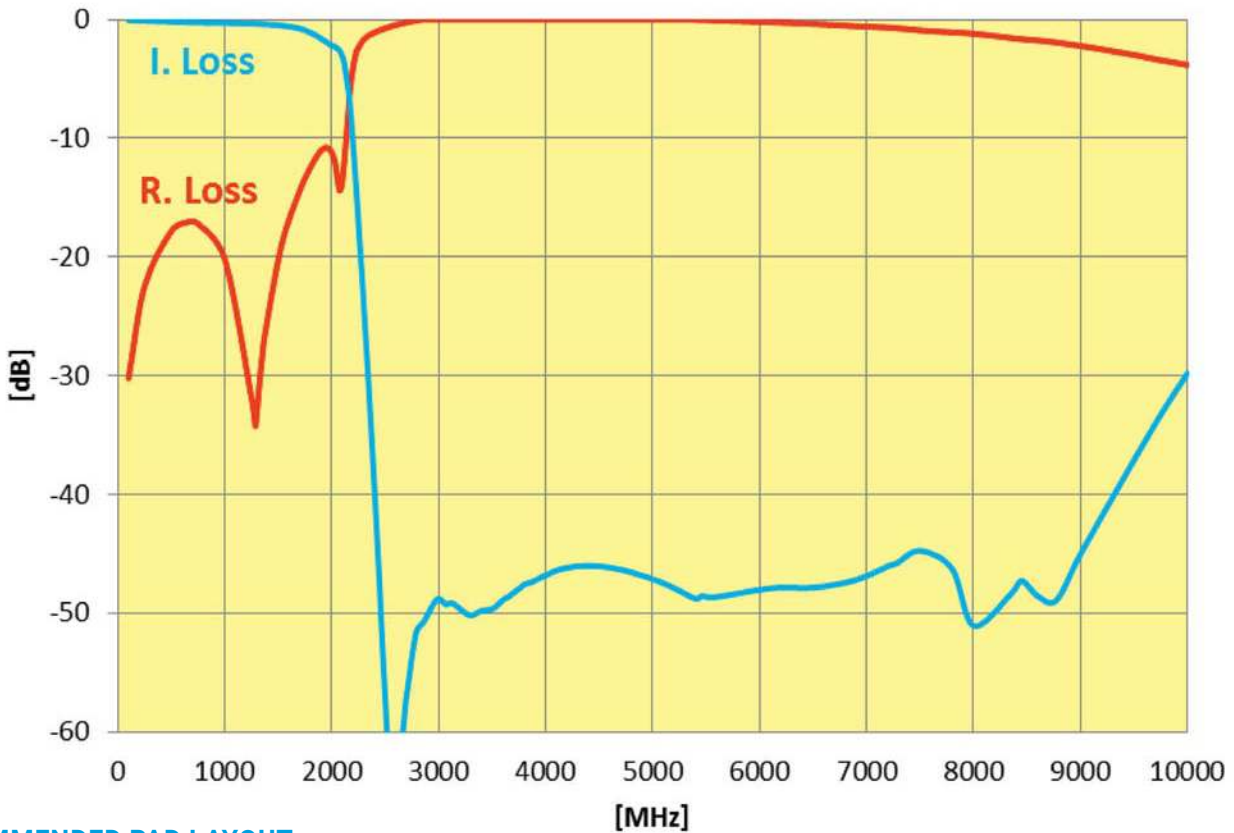

#### RECOMMENDED PAD LAYOUT

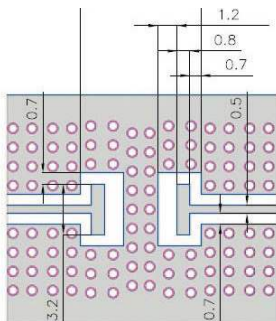

#### ORIENTATION MARKING CODE



# Thin-Film RF/Microwave Filters

## 2816 High Performance Low Pass 20W

### LP2816A1800SNTR – LGA Termination



#### TYPICAL ELECTRICAL PERFORMANCE

Parameter	Value	Unit	Notes
Fc	1800	MHz	
Rejection @2.52GHz	-19	dB	Min.
Rejection 2.8GHz-8.5GHz	-40	dB	Min.
Rejection 8.5GHz-10GHz	-35	dB	Min.
Insertion Loss @1800MHz	-0.75	dB	Max.
Return Loss @1800MHz	-20	dB	Typ.
Power Handling	20	W	RF Continuous
Impedance	50	Ohm	
Operating Temp.	-40 to +85	°C	
Size	7x4x1.2mm		

[Click here to return to main table](#)

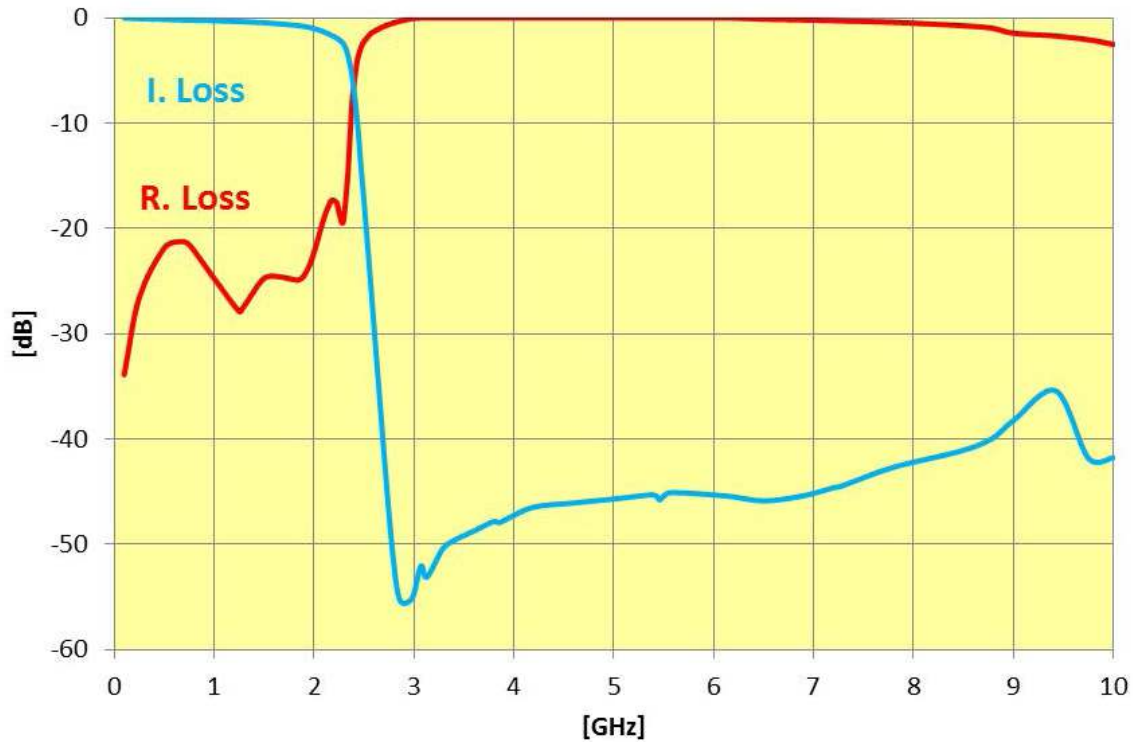

#### RECOMMENDED PAD LAYOUT

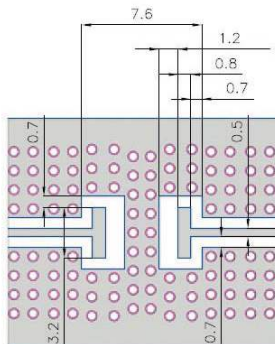

#### ORIENTATION MARKING CODE



# Thin-Film RF/Microwave Filters

## 2816 High Performance Low Pass 20W

### LP2816A1900SNTR – LGA Termination



#### TYPICAL ELECTRICAL PERFORMANCE

Parameter	Value	Unit	Notes
Fc	1900	MHz	
Rejection @2.66GHz	-35	dB	Min.
Rejection 2.5GHz-10GHz	-40	dB	Min.
Insertion Loss @1900MHz	-0.8	dB	Max.
Return Loss @1900MHz	-23	dB	Typ.
Power Handling	20	W	RF Continuous
Impedance	50	Ohm	
Operating Temp.	-40 to +85	°C	
Size	7x4x1.2mm		

[Click here to return to main table](#)

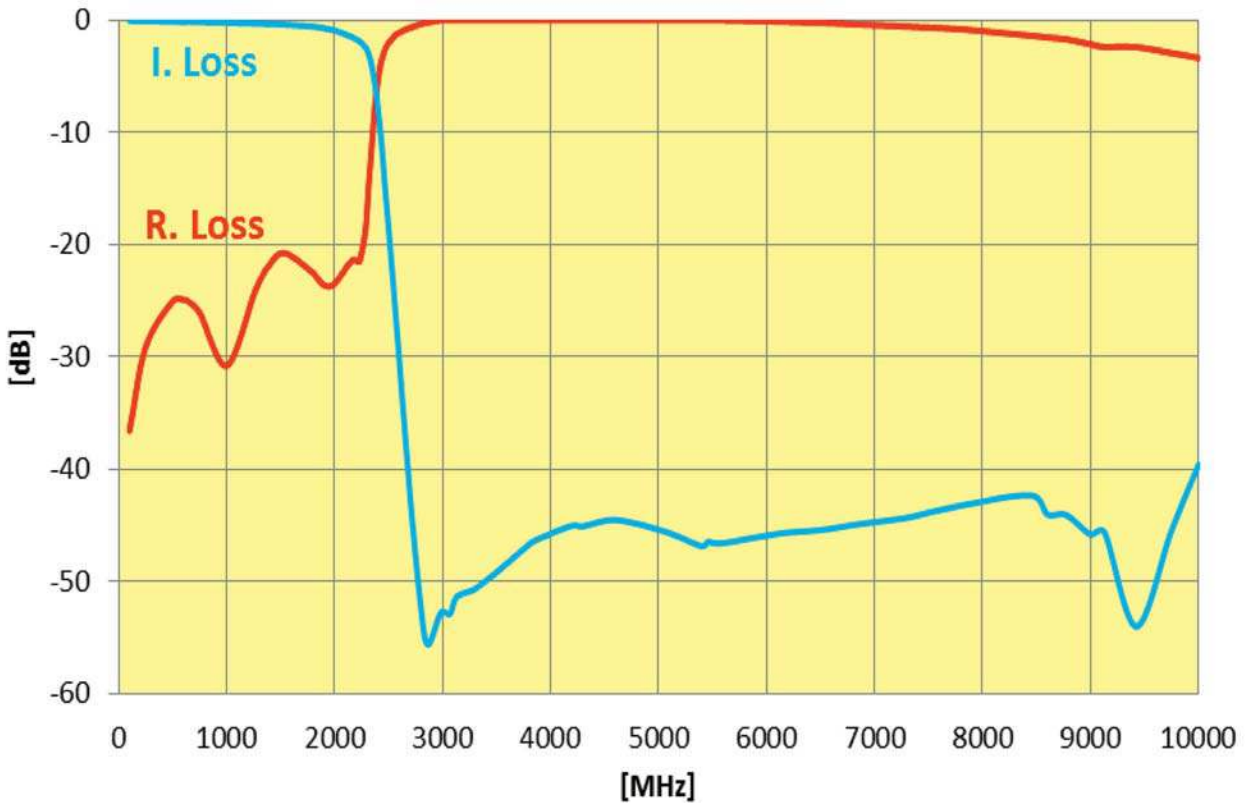

#### RECOMMENDED PAD LAYOUT

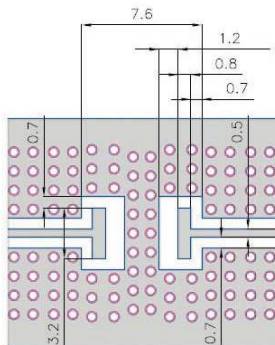

#### ORIENTATION MARKING CODE







# Thin-Film RF/Microwave Filters

## 2816 High Performance Low Pass 20W

### LP2816A2500SNTR – LGA Termination

#### TAPE & REEL

All tape and reel specifications are in compliance with EIA 481-1-A (equivalent to IEC 286 part 3).

- 12mm carrier
- Reeled quantities: Reels of 2,000 per 7" reel

#### REEL DIMENSIONS: millimeters

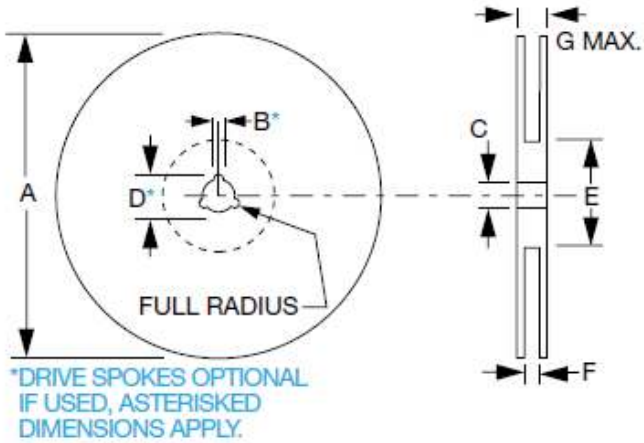

A	B	C	D	E	F	G
180±1.0	1.5 min.	13±0.2	20.2 min.	50 min.	13.6±0.1	16.6

#### CARRIER

