

AMMP-6546

18 to 40 GHz GaAs MMIC Sub-Harmonic Mixer
In SMT Package



Data Sheet

Description/Applications

Avago's AMMP-6546 is an easy-to-use broadband sub-harmonic mixer, with the LO injected at half of the frequency of that required by a conventional mixer. AMMP-6546 is similar to AMMP-6545 except that the layout is a mirror image designed to ease integration into transmitter or receiver designs. The MMIC includes an 180° balanced diode based mixer. The MMIC is fabricated using PHEMT technology. The surface mount package allows elimination of "chip & wire" assembly for lower cost. This MMIC is a cost effective alternative to multi-chip solution that have higher loss and complex assembly.

Package Marking & Orientation

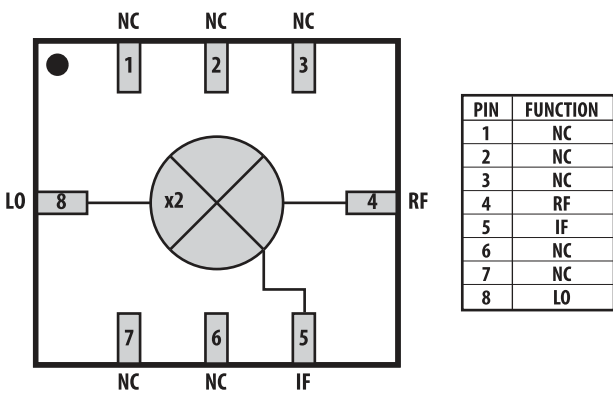

TOP VIEW
PACKAGE BASE: GND



Attention: Observe precautions for handling electrostatic sensitive devices.
ESD Machine Model = 30 V
ESD Human Body Model = 150 V
Refer to Avago Application Note A004R:
Electrostatic Discharge, Damage and Control.

Features

- RF Frequency : 18-40 GHz
- LO Frequency : 9-20 GHz
- IF Frequency : DC-3.5 GHz
- 5x5 mm Surface Mount Package
- Suitable for Up and Down Conversion
- Diode Mixer
- **Typical Performance at RF= 21GHz**
Conversion Loss : 11 dB
IIP3 : +12 dBm
2LO-R Leakage : -44 dBm
2LO-I Leakage : -61 dBm
- **Typical Performance at RF= 23GHz**
Conversion Loss : 10 dB
IIP3 : +11.7 dBm
2LO-R Leakage : -40 dBm
2LO-I Leakage : -64 dBm
- **Typical Performance at RF= 26GHz**
Conversion Loss : 11 dB
IIP3 : +11.8 dBm
2LO-R Leakage : -42 dBm
2LO-I Leakage : -60 dBm

Applications

- Microwave radio systems
- Satellite VSAT, DBS up/down link
- LMDS & Pt-Pt mmW long haul
- Broadband wireless access (including 802.16 and 802.20 WiMax)
- WLL and MMDS loops

Absolute Maximum Ratings ^[1] at T_C = +25°C

Symbol	Parameter	Unit	Max Rating
Pin	RF CW Input Power Max	dBm	+25
Tstg	Storage Temperature	°C	-65 to +150
Tmax _j	Maximum Assembly Temp.	°C	300 for 60s

Notes:

1. Operation in excess of any one of these conditions may result in permanent damage to the device.
2. Ambient operational temperature, T_A=25°C unless noted.

AMMP-6546 Operating Conditions

Symbol	Parameter	Units	Minimum	Typical	Maximum
RF freq	RF Frequency	GHz	18	–	40
LO freq	LO Frequency	GHz	9	–	20
IF freq	IF Frequency	GHz	DC	–	3.5
LO	LO Power	dBm	+12	+15	+22

AMMP-6546 RF Specifications

T_A = 25°C, Z_o = 50 Ω, LO = +15 dBm, IF = 2 GHz

Symbol	Test Parameter	Units	RF frequency (GHz)	LO frequency (GHz)	RF Performance		
					Min.	Typ.	Max.
CL	Conversion Loss	dB	21	11.5	11	12	
			23	12.5			
			26	14			
IIP3	Input Third Order Intercept	dBm	21	11.5	11	12	
			23	12.5			
			26	14			
2LO-R	2LO-R Leakage	dBm	21	10.5	-44	-35	
			23	11.5			
			26	13			
2LO-I	2LO-I Leakage	dBm	21	10.5	-61	-52.5	
			23	11.5			
			26	13			
L-R	L-R Leakage	dB	18-30	9-15	-30	-35	
			30-40	15-20			
L-I	L-I Leakage	dB	18-30	9-15	-35	-30	
			30-40	15-20			

Note:

1. Production RF tested at 21, 23 and 26 GHz in up-converter configuration at Low Side LO.
2. All tested parameters are guaranteed with the following measurement accuracy:
 RF=21GHz: ±1 dBm for RF-leakage, ±2.0 dBm for IF-leakage, ±0.5dB for Conversion Loss, ±0.5 dBm for IIP3
 RF=23GHz: ±1 dBm for RF-leakage, ±2.5 dBm for IF-leakage, ±0.5dB for Conversion Loss, ±0.5 dBm for IIP3
 RF=26GHz: ±1 dBm for RF-leakage, ±2.5 dBm for IF-leakage, ±0.5dB for Conversion Loss, ±0.5 dBm for IIP3
3. Typical values were derived using limited samples during initial product characterization and may not be representative of the overall distribution.

AMMP-6546 Typical Performance Curves

($T_A = +25^\circ\text{C}$, $Z_{in}=Z_{out}=50\Omega$, IF Freq = 2GHz, LO Power = +15dBm unless noted)

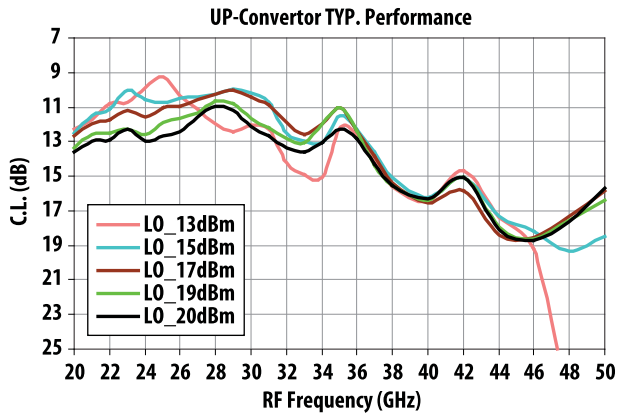

Figure 1. Up-conversion loss at LO = +13 to +20 dBm (high side LO)

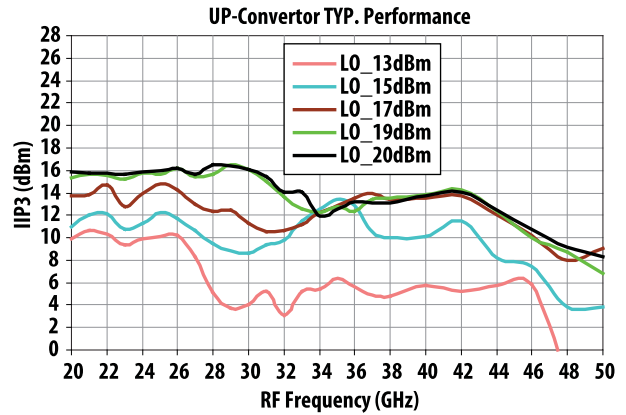

Figure 2. Up-conversion IIP3 at LO = +13 to +20 dBm (high side LO)

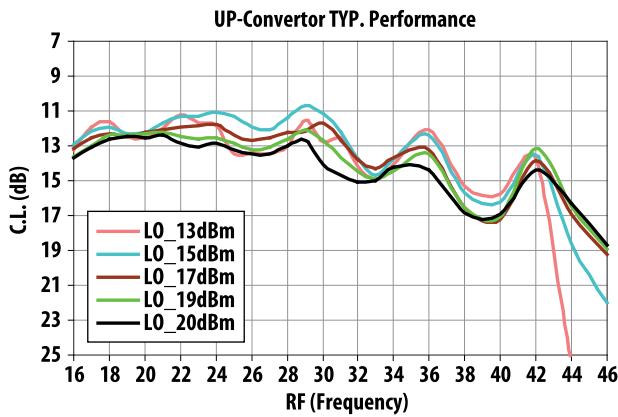

Figure 3. Up-conversion loss at LO = +13 to +20 dBm (low side LO)

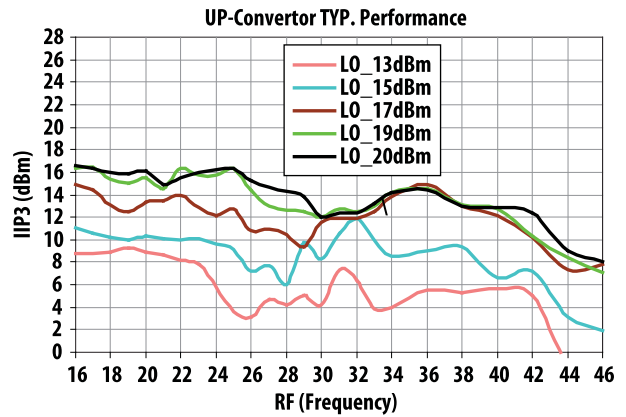

Figure 4. Up-conversion IIP3 at LO = +13 to +20 dBm (low side LO)

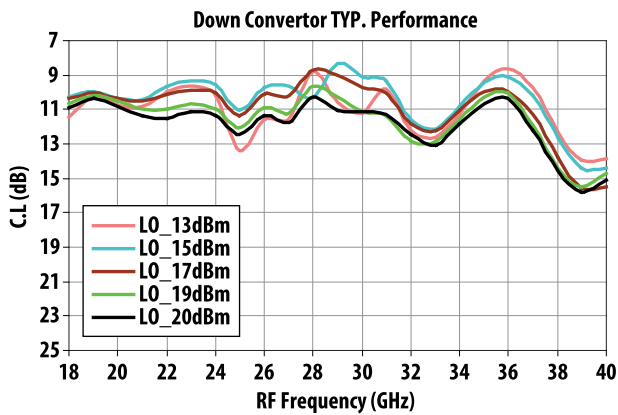

Figure 5. Down-conversion loss at LO = +13 to +20 dB (low side LO)

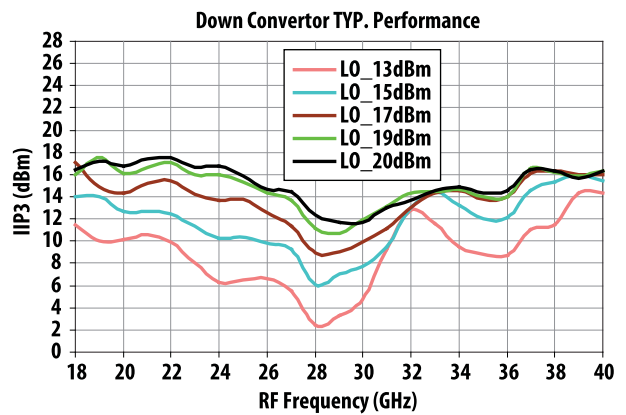

Figure 6. Down-conversion IIP3 at LO = +13 to +20 dBm (low side LO)

Notes:

1. Typical values were derived using limited samples during initial product characterization and may not be representative of the overall distribution.

AMMP-6546 Typical Performance Curves

($T_A = +25^\circ\text{C}$, $Z_{in}=Z_{out}=50\Omega$, IF Freq = 2GHz, LO Power = +15dBm unless noted)

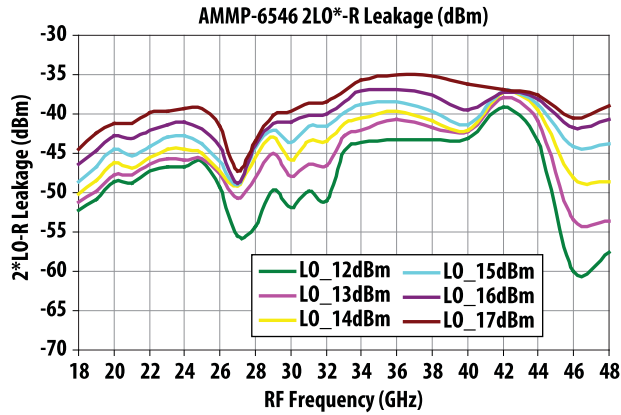

Figure 7. 2*LO*-R leakage at LO = +12 to +17 dBm

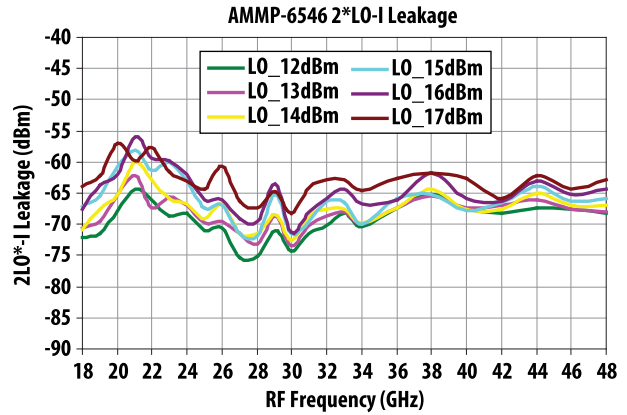

Figure 8. 2*LO*-I leakage at LO = +12 to +17 dBm

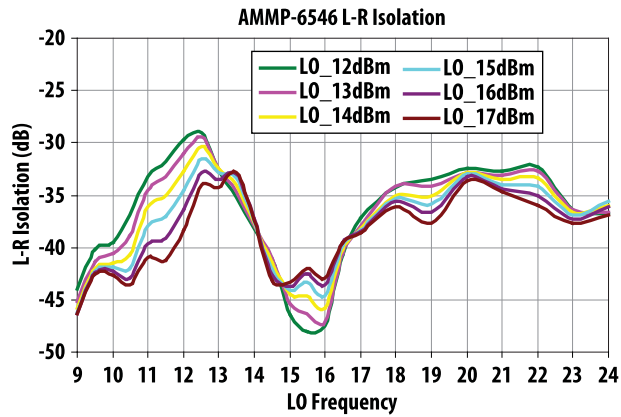

Figure 9. L-R isolation at LO = +12 to +17dBm

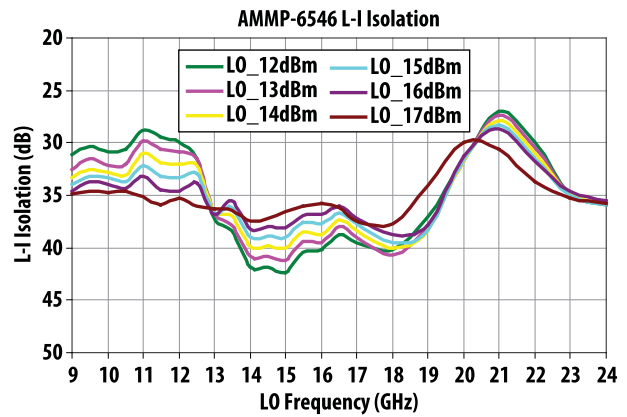

Figure 10. L-I isolation at LO = +12 to +17dBm

Notes:

1. Typical values were derived using limited samples during initial product characterization and may not be representative of the overall distribution.

AMMP-6546 Application and Usage

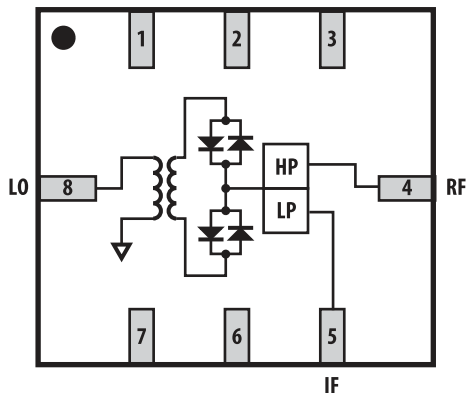

Figure 11. Simplified schematic of the mixer

Recommended SMT Attachment for 5x5 Package

The AMMP Packaged Devices are compatible with high volume surface mount PCB assembly processes.

The PCB material and mounting pattern, as defined in the data sheet, optimizes RF performance and is strongly

recommended. An electronic drawing of the landpattern is available upon request from Avago Sales & Application Engineering.

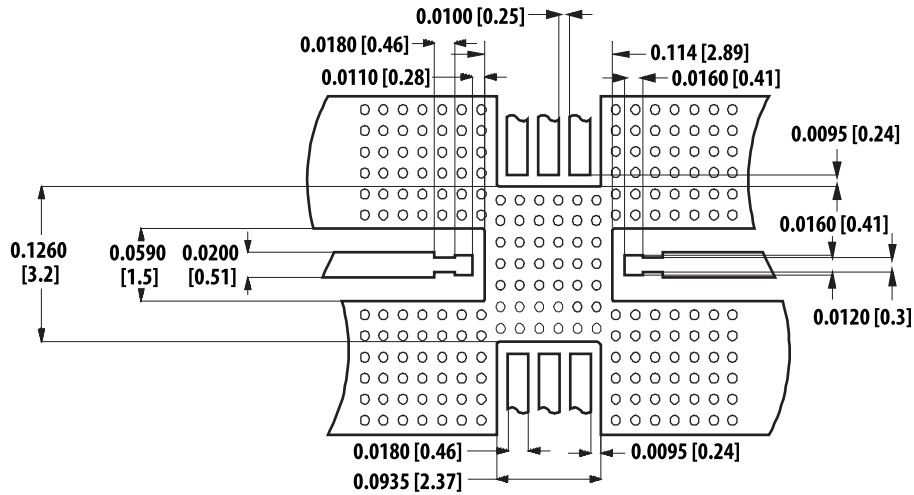

Figure 13a. PCB land pattern

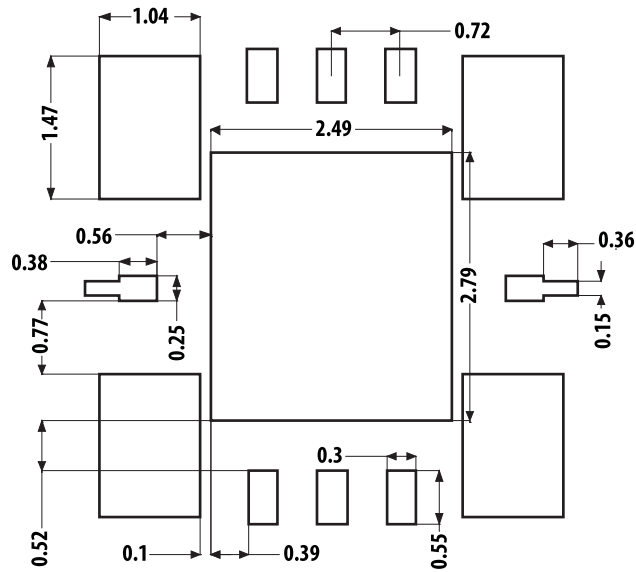

Figure 13b. PCB stencil layouts

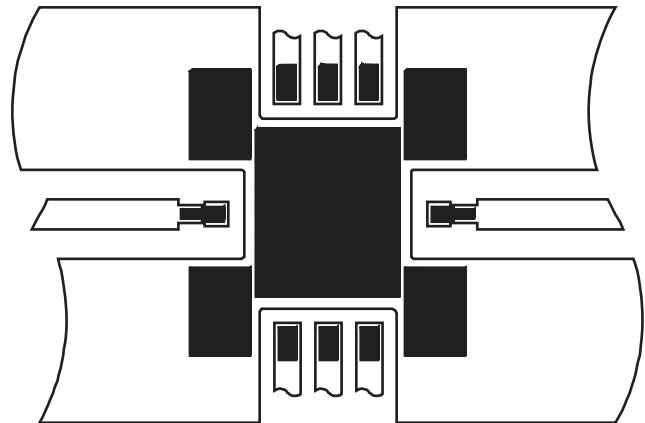

Figure 13c. PCB land pattern with stencil layouts

Manual Assembly

- Follow ESD precautions while handling packages.
- Handling should be along the edges with tweezers.
- Recommended attachment is conductive solder paste. Please see recommended solder reflow profile. Neither Conductive epoxy or hand soldering is recommended.
- Apply solder paste using a stencil printer or dot placement. The volume of solder paste will be dependent on PCB and component layout and should be controlled to ensure consistent mechanical and electrical performance.
- Follow solder paste and vendor's recommendations when developing a solder reflow profile. A standard profile will have a steady ramp up from room temperature to the pre-heat temperature to avoid damage due to thermal shock.
- Packages have been qualified to withstand a peak temperature of 260°C for 20 seconds. Verify that the profile will not expose device beyond these limits.

A properly designed solder screen or stencil is required to ensure optimum amount of solder paste is deposited onto the PCB pads. The recommended stencil layout is shown in Figure 13. The stencil has a solder paste deposition opening approximately 70% to 90% of the PCB pad. Reducing stencil opening can potentially generate more voids underneath. On the other hand, stencil openings larger than 100% will lead to excessive solder paste smear

or bridging across the I/O pads. Considering the fact that solder paste thickness will directly affect the quality of the solder joint, a good choice is to use a laser cut stencil composed of 0.127 mm (5 mils) thick stainless steel which is capable of producing the required fine stencil outline.

The most commonly used solder reflow method is accomplished in a belt furnace using convection heat transfer. The suggested reflow profile for automated reflow processes is shown in Figure 14. This profile is designed to ensure reliable finished joints. However, the profile indicated in Figure 14 will vary among different solder pastes from different manufacturers and is shown here for reference only.

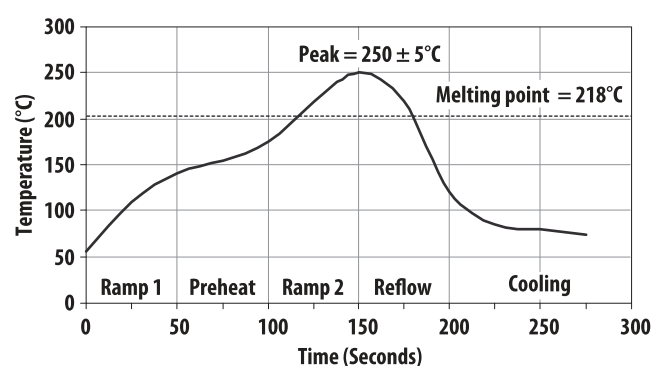
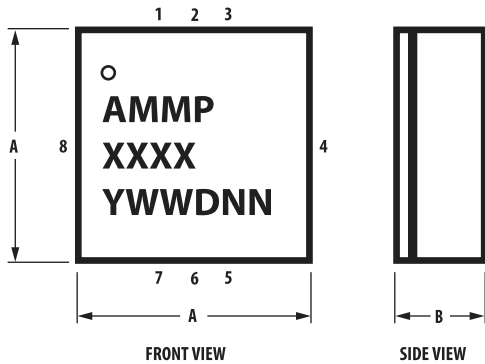

Figure 14. Suggested lead-free reflow profile for SnAgCu solder paste

AMMP-6546 Part Number Ordering Information

Part Number	No. of Devices	Container
AMMP-6546-BLKG	10	antistatic bag
AMMP-6546-TR1G	100	7" Reel
AMMP-6546-TR2G	500	7" Reel

Package Dimensions



SYMBOL	MIN.	MAX.
A	0.198 (5.03)	0.213 (5.4)
B	0.0685 (1.74)	0.088 (2.25)

DIMENSIONS ARE IN INCHES (MM)

NOTES:

- * INDICATES PIN 1
- DIMENSIONS ARE IN INCHES (MILLIMETERS)
- ALL GROUNDS MUST BE SOLDERED TO PCB RF GROUND

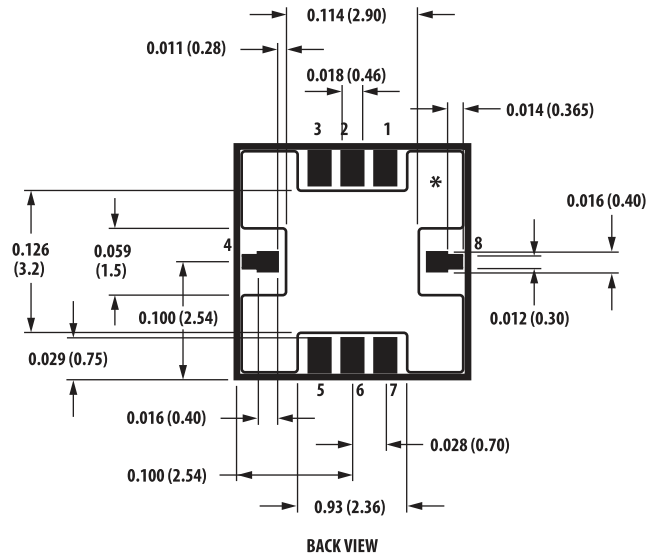

DIMENSIONAL TOLERANCE FOR BACK VIEW: 0.002" (0.05 mm)

Tape Dimensions

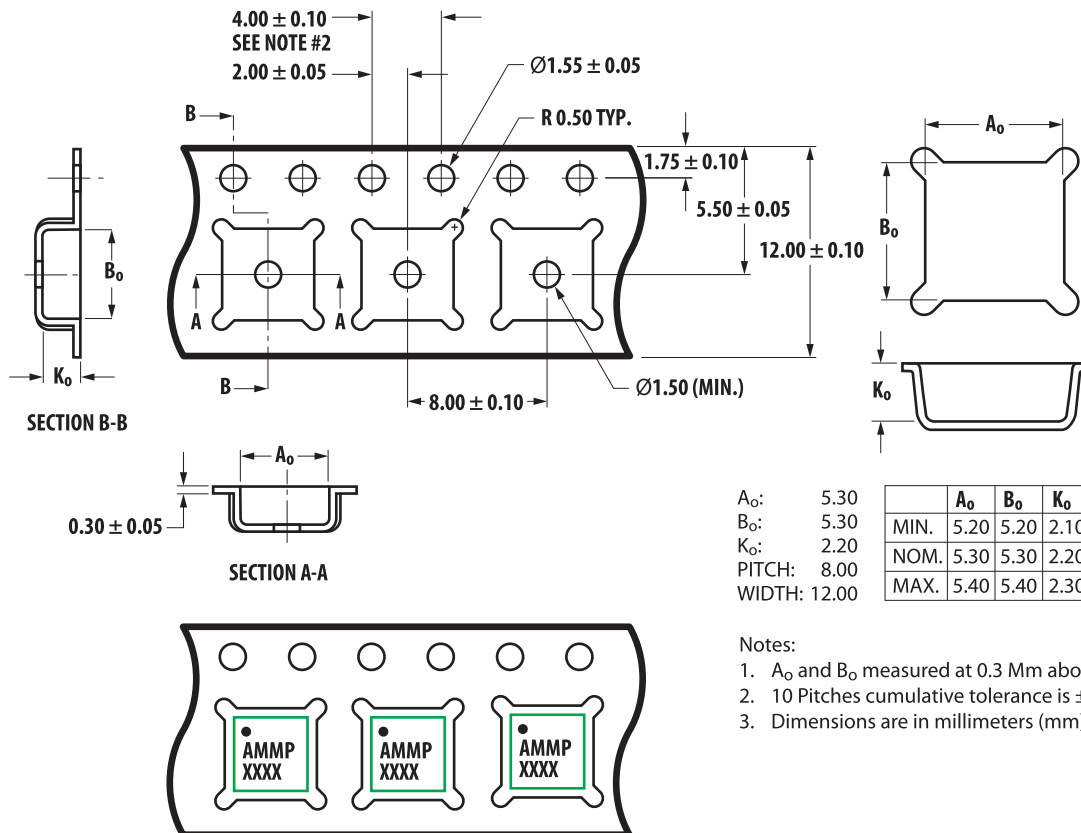

A ₀ :	5.30				
B ₀ :	5.30				
K ₀ :	2.20				
PITCH:	8.00				
WIDTH:	12.00				
		A ₀	B ₀	K ₀	
		MIN.	5.20	5.20	2.10
		NOM.	5.30	5.30	2.20
		MAX.	5.40	5.40	2.30

Notes:

- A₀ and B₀ measured at 0.3 Mm above base of pocket.
- 10 Pitches cumulative tolerance is ± 0.2 Mm.
- Dimensions are in millimeters (mm).

For product information and a complete list of distributors, please go to our web site: www.avagotech.com

Avago, Avago Technologies, and the A logo are trademarks of Avago Technologies in the United States and other countries. Data subject to change. Copyright © 2005-2010 Avago Technologies. All rights reserved. AV02-1662EN - January 20, 2010

AVAGO
TECHNOLOGIES