



# Mag Layers USA, INC

## Specification Sheet

**P/N : GMLB-160808-1000L-N8A-RU**

### Products:

[Molded Power Chokes](#)

[Multilayer Chip Inductors](#)

[Lan Transformer](#)

[RF Passive / Antennas](#)

[Automotive](#)

### Certifications:

[ISO9001](#)

[IATF16949](#)

[ISO14001](#)

[QC080000](#)

### US Office

5406 Bolsa Ave.,  
Huntington Beach, CA 92649  
(714) 898-8377

### Contact Us

[www.maglayersusa.com](http://www.maglayersusa.com)  
[info@maglayersusa.com](mailto:info@maglayersusa.com)



## PRODUCT DIMENSION

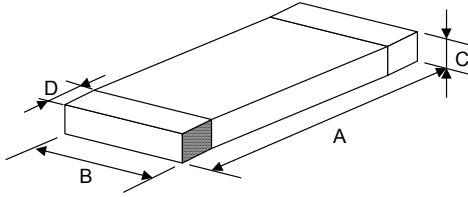

NOTE : Dimensions in mm

PRODUCT NO.	A	B	C	D
GMLB-453215 (1812)	4.5±0.20 (0.177±0.008)	3.2±0.20 (0.126±0.008)	1.5±0.20 (0.059±0.008)	0.5±0.30 (0.020±0.012)
GMLB-451616 (1806)	4.5±0.20 (0.177±0.008)	1.6±0.20 (0.063±0.008)	1.6±0.20 (0.063±0.008)	0.5±0.30 (0.020±0.012)
GMLB-322513 (1210)	3.2±0.20 (0.126±0.008)	2.5±0.20 (0.098±0.008)	1.3±0.20 (0.051±0.008)	0.5±0.30 (0.020±0.012)
GMLB-321616 (1206)	3.2±0.20 (0.126±0.008)	1.6±0.20 (0.063±0.008)	1.6±0.20 (0.063±0.008)	0.5±0.30 (0.020±0.012)
GMLB-321611 (1206)	3.2±0.20 (0.126±0.008)	1.6±0.20 (0.063±0.008)	1.1±0.20 (0.043±0.008)	0.5±0.30 (0.020±0.012)
GMLB-201209 (0805)	2.0±0.20 (0.079±0.008)	1.2±0.20 (0.047±0.008)	0.9±0.20 (0.035±0.008)	0.5±0.30 (0.020±0.012)
GMLB-160808 (0603)	1.6±0.15 (0.063±0.006)	0.8±0.15 (0.031±0.006)	0.8±0.15 (0.031±0.006)	0.3±0.20 (0.012±0.008)

## CURRENT DERATING

In operating temperatures exceeding +85°C, derating of current is necessary for chip ferrite beads for which rated current is 1.5A or over. Please apply the derating curve shown below according to the operating temperature.

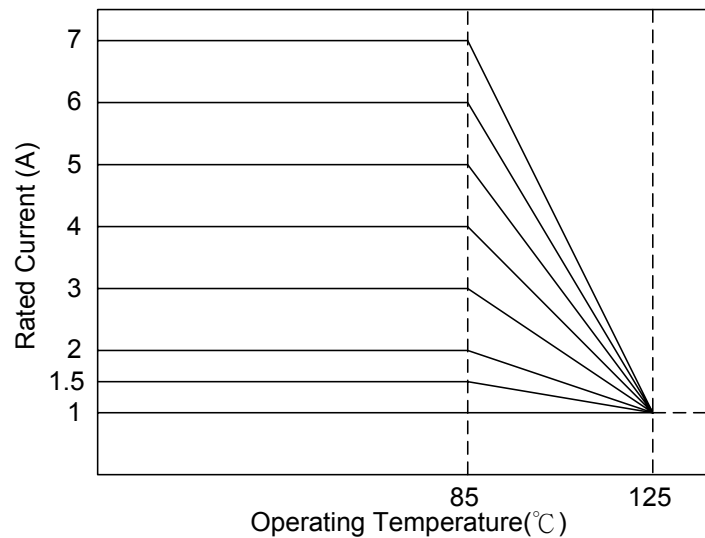

## ELECTRICAL REQUIREMENTS

Part Number	Impedance ( $\Omega$ ) at 100 MHz	$R_{DC}$ ( $\Omega$ ) Max.	Rated Current (mA) Max.	Operating Temp. Range ( $^{\circ}\text{C}$ )
GMLB-160808-1000L-N8A-RU	1000 $\pm$ 25%	0.4	400	-55 ~ +125

- Temperature rise should be less than 40 $^{\circ}\text{C}$  for P-type and less than 25 $^{\circ}\text{C}$  for other types when rated current is applied.

## MEASURING METHOD / CONDITION

- Test Instrument:

Z: Agilent 4291B Impedance Analyzer, Test Fixture: Agilent 16192  
Osc. Level: 500mV

$R_{DC}$ : Agilent 34401A

- Test Condition:

< Unless otherwise specified >

Temperature: 15 $^{\circ}\text{C}$  to 35 $^{\circ}\text{C}$  Humidity: 25% to 85% RH

< In case of doubt >

Temperature: 25 $^{\circ}\text{C} \pm 2^{\circ}\text{C}$  Humidity: 60% to 70% RH

## TYPICAL ELECTRICAL CHARACTERISTICS (T=25 $^{\circ}\text{C}$ )

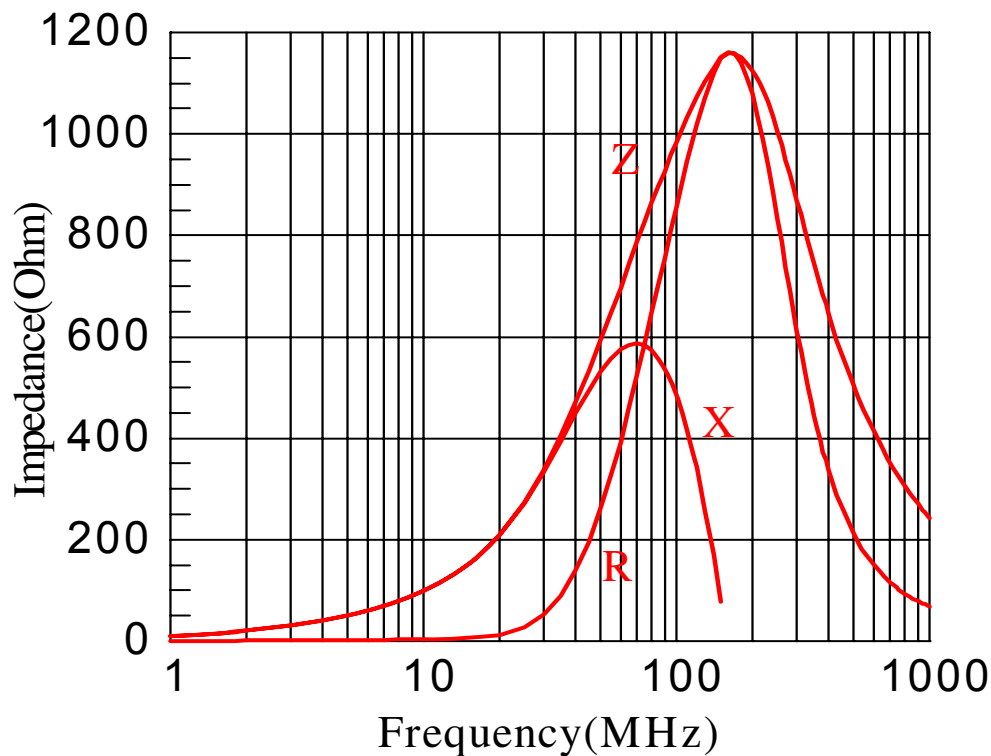

# PACKAGING

## ● Peel-off Force

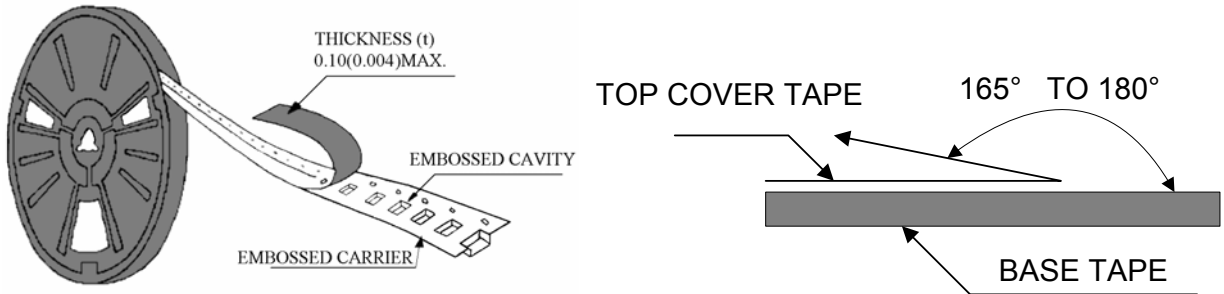

The force for peeling off cover tape is 10 grams in the arrow direction.

## ● Dimension (Unit: mm)

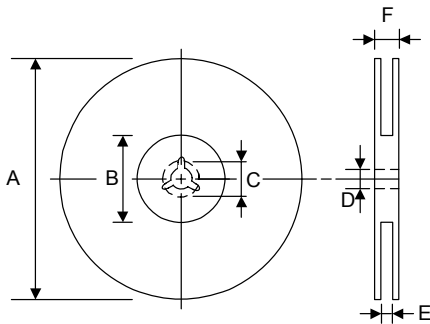

TYPE	A	B	C	D	E	F
8 mm	178±1	60 +0.5 -0	-	13 ±0.2	9 ±0.5	12 ±0.5
12 mm	178±0.3	60 ±0.2	19.3 ±0.1	13.5 ±0.1	13.6 ±0.1	-

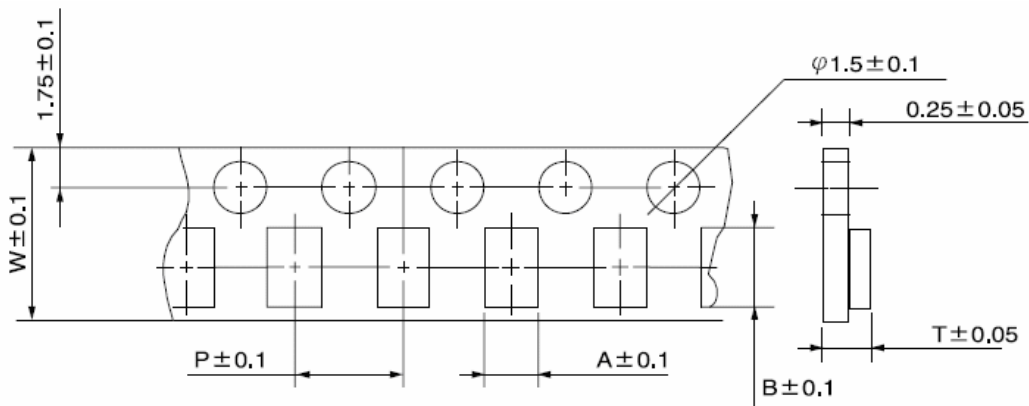

TYPE	SIZE	A	B	W	P			CHIPS/REEL
GMLB	160808	1.1	1.9	8	4	1.1,	*0.95±0.05	4000
	201209	1.5	2.3	8	4	1.3,	*0.95±0.10	4000
	321611	1.9	3.5	8	4		1.5	3000
	321616	1.9	3.5	8	4		2.0	3000
	322513	2.9	3.6	8	4		1.7	2500
	451616	1.9	4.9	12	4		2.0	2000
	453215	3.6	4.9	12	8		1.9	1000

\*: For paper reels

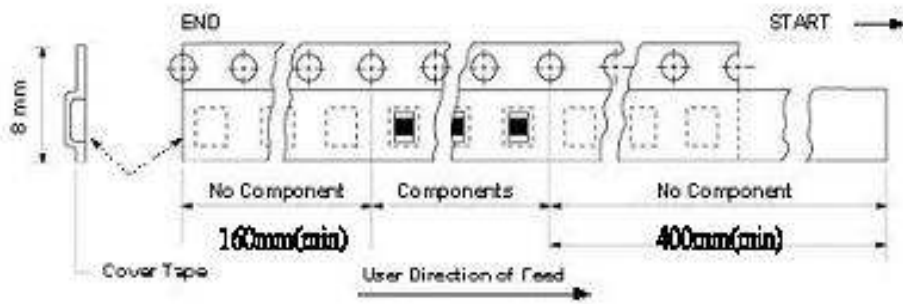

● Taping Quantity

SERIES	4532	4516	3225	3216	2012	1608
PCS/Reel	1000	2000	2500	3000	4000	4000

● Tape Packing Case

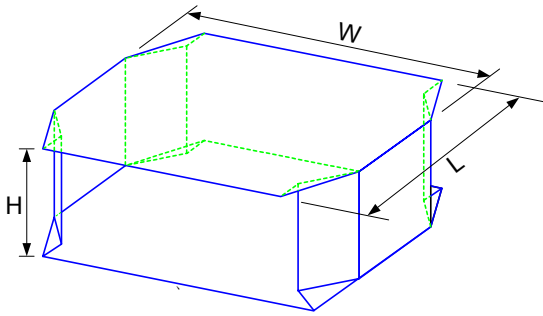

No. of Reels	W	L	H
2	18±0.5	18±0.5	2.4±0.2
3	18±0.5	18±0.5	3.6±0.2
4	18±0.5	18±0.5	4.8±0.2
5	18±0.5	18±0.5	6.0±0.2

Unit: cm

■ RECOMMENDED PCB LAYOUT

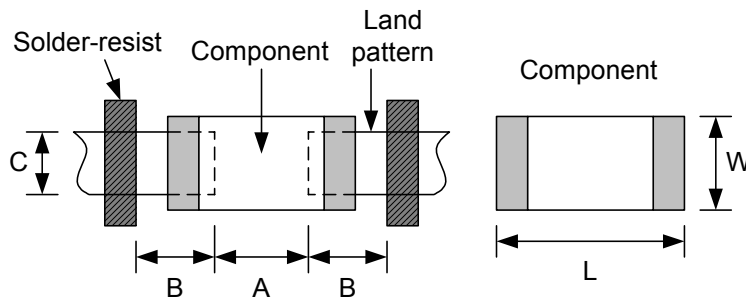

Unit: mm

Type	1608	2012	3216	3225	4516	4532	
Size	L	1.6	2.0	3.2	3.2	4.5	4.5
	W	0.8	1.2	1.6	2.5	1.6	3.2
A	0.6~0.8	0.8~1.2	1.8~2.2	1.8~2.2	3.4	3.4	
B	0.6~0.8	0.8~1.2	1.1~1.6	1.1~1.6	1.5	1.5	
C	0.6~0.8	0.9~1.6	0.9~1.6	3.40	1.4	4.2	

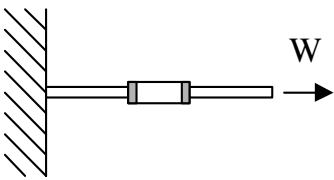
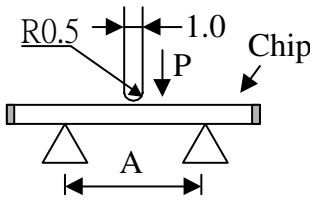

## RELIABILITY TEST

• Mechanical Performance Test				
ITEM	SPECIFICATION	TEST CONDITION		
Solderability	More than 90% of the terminal electrode shall be covered with fresh solder.	Solder: 96.5Sn-3.0Ag-0.5Cu Solder Temperature: 245 ± 5°C Flux: Rosin Dip Time: 3 ± 1 Seconds		
Soldering Heat Resistance	The chip shall not crack. More than 75% of the terminal electrode shall be covered with solder.	Solder: 96.5Sn-3.0Ag-0.5Cu Solder temperature : 260 ± 5°C Flux: Rosin Dip time: 10 ± 1 seconds		
Terminal Strength	The terminal electrode shall not be broken off nor the ferrite damaged.  	TYPE	W(KGF)	TIME (SEC)  30 ± 5
		GMLB-160808	0.6	
		GMLB-201209		
		GMLB-321611	1.0	
		GMLB-321616		
		GMLB-322513		
		GMLB-451616		
GMLB-453215	1.5			
Bending Strength	No mechanical damage. The ferrite shall not be damaged.  	TYPE	A(MM)	P(KGF)
		GMLB-160808	1.0	1.0
		GMLB-201209	1.4	
		GMLB-321611	2.0	2.0
		GMLB-321616		
		GMLB-322513		
		GMLB-451616	2.5	2.5
GMLB-453215	2.7			
• Climatic test				
ITEM	SPECIFICATION	TEST CONDITION		
Thermal Shock (Temperature Cycle)	Impedance shall be within ± 20% of the initial value.	Temperature: -55°C~125°C for 30 minutes each, 100 cycles.		
Humidity Resistance		Temperature : 60°C Humidity: 95% RH Time: 1000 ± 12 Hours		
High Temperature Resistance		Temperature : 85°C±2°C Time: 1000 ± 12 Hours		
1. Operating Temperature Range: -55 °C TO +125°C 2. Storage Condition: The temperature should be within -40°C~85°C and humidity should be less than 75% RH. The product should be used within 6 months from the time of delivery.				

## RECOMMENDED REFLOW SOLDERING PROFILE

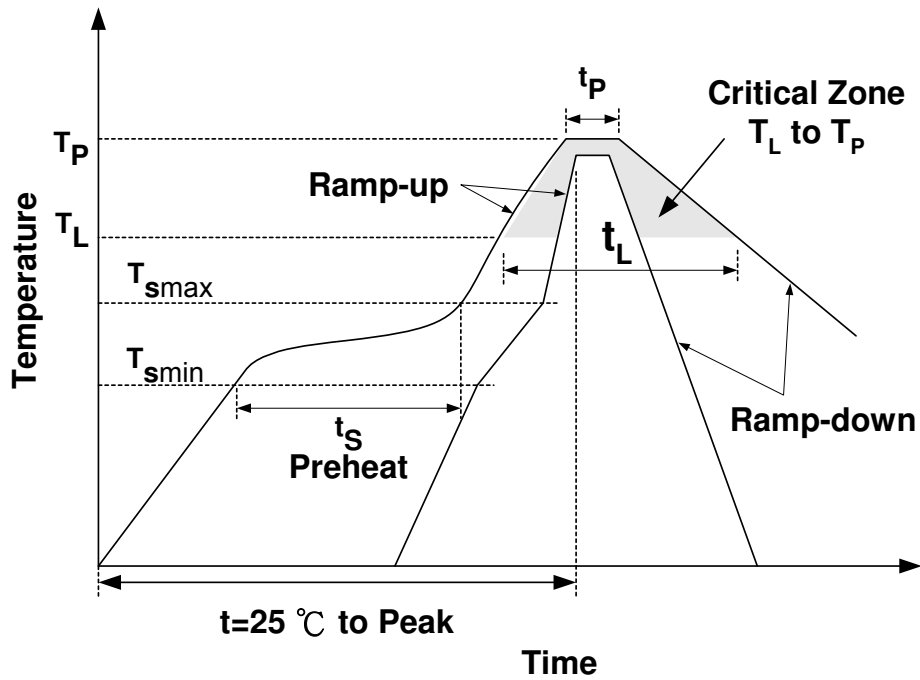

Profile Feature		Sn-Pb	Pb-Free
Preheat	$t_s$	60~120 seconds	60~180 seconds
	$T_{smin}$	100°C	150°C
	$T_{smax}$	150°C	200°C
Average ramp-up rate ( $T_{smax}$ to $T_P$ )		3°C/second max.	3°C/second max.
Time main above	Temperature ( $T_L$ )	183°C	217°C
	Time ( $t_L$ )	60~150 seconds	60~150 seconds
Peak temperature ( $T_P$ )		230°C	250~260°C
Time within 5°C of actual peak temperature ( $t_p$ )		10 seconds	10 seconds
Ramp-down rate		6°C/sec max.	6°C/sec max.
Time 25°C to peak temperature		6 minutes max.	8 minutes max.

## NOTES

The contents of this data sheet are subject to change without notice. Please confirm the specifications and delivery conditions when placing your order.