

THIS DOCUMENT CONTAINS DATA PROPRIETARY TO PROJECTS UNLIMITED, INC. ANY USE OR REPRODUCTION, IN ANY FORM, WITHOUT PRIOR WRITTEN PERMISSION OF PROJECTS UNLIMITED, INC. IS PROHIBITED.
© 2005, Projects Unlimited Inc.

SPECIFICATIONS

PARAMETERS	VALUES	UNITS
RATED INPUT POWER	0.5	W
MAX INPUT POWER	0.8	W
IMPEDANCE	32±15%	OHM
OUTPUT SPL @ 0.1W/0.1M (AT 0.8, 1.0, 1.2, 1.5 kHz)	85±3	dBA
DISTORTION (MAX.)	5%	-
RESONANT FREQUENCY	920±20%	Hz
FREQUENCY RANGE	920 ~ 5000	Hz
HOUSING MATERIAL	METAL	-
CONE MATERIAL	MYLAR	-
MAGNET MATERIAL	Nd-Fe-B	-
OPERATING TEMPERATURE	-30 +70	°C
WEIGHT	1.18	grams

REVISIONS			
LTR	DESCRIPTION	DATE	APPROVED
-	RELEASED FROM ENGINEERING	4/21/10	

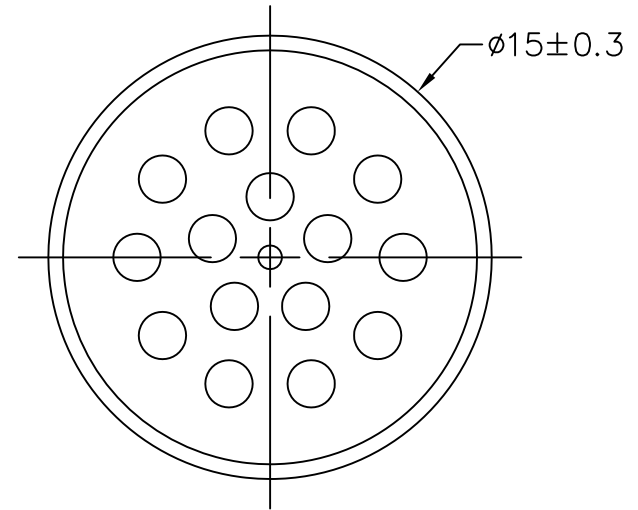
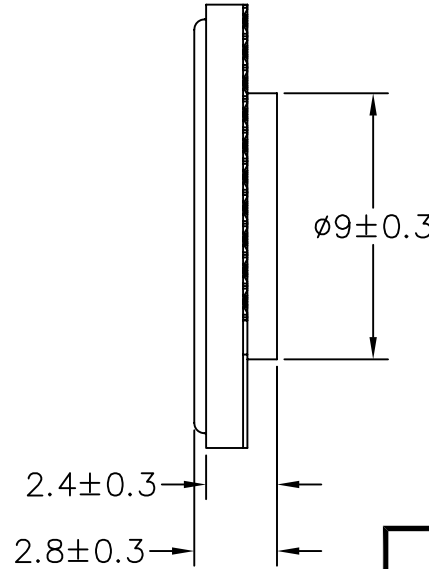
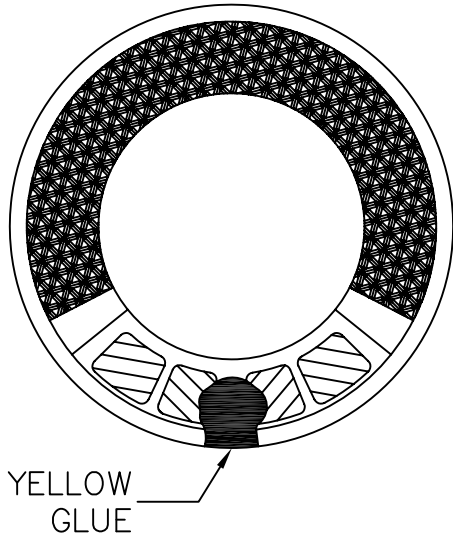

NOTES:

- ALL DIMENSIONS ARE IN MILLIMETERS.
- SPECIFICATION SUBJECT TO CHANGE OR WITHDRAWAL WITHOUT NOTICE.
- THIS PART IS RoHS 2002/95/EC COMPLIANT.

FILE NAME
AS01532MR-R.DWG

UNLESS OTHERWISE SPECIFIED: DIMENSIONS ARE IN MILLIMETERS, TOLERANCES ARE ±0.5 AND ANGLES ARE ±3°.		 A Division of Projects Unlimited		6300 Sand Lake Road Dayton, Ohio 45414	
APPROVALS		DATE		SPEAKER DRAWING NO. AS01532MR-R	
DRAWN	J.D.	4/10			
CHECKED	C.W.	4/10			
APPROVED		B.R.	4/10	SIZE A	SCALE: N.T.S.
				SHEET 1 OF 1	