

Main Product Characteristics

V_{DS}	30V
$R_{DS(ON)}$	12m Ω
I_D	10A

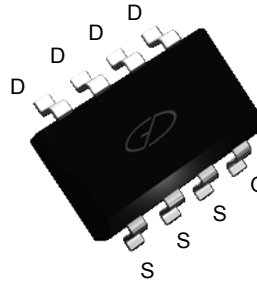

SOP-8

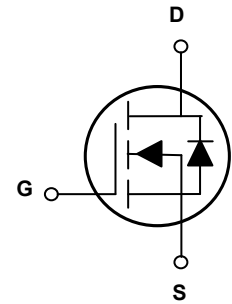

Schematic Diagram

Features and Benefits

- Advanced MOSFET process technology
- Ideal for high efficiency switched mode power supplies
- Low on-resistance with low gate charge
- Fast switching and reverse body recovery



Description

The SSFQ3910 utilizes the latest techniques to achieve high cell density and low on-resistance. These features make this device extremely efficient and reliable for use in high efficiency switch mode power supply and a wide variety of other applications.

Absolute Maximum Ratings (T_c=25°C unless otherwise specified)

Parameter	Symbol	Rating	Unit
Drain-Source Voltage	V_{DS}	30	V
Gate-Source Voltage	V_{GS}	± 20	V
Drain Current – Continuous (T _c =25°C)	I_D	10	A
Drain Current – Continuous (T _c =100°C)		6.3	A
Drain Current – Pulsed ¹	I_{DM}	40	A
Single Pulse Avalanche Energy ²	E_{AS}	13	mJ
Single Pulse Avalanche Current ²	I_{AS}	16	A
Power Dissipation (T _c =25°C)	P_D	2.1	W
Power Dissipation – Derate above 25°C		0.017	W/°C
Storage Temperature Range	T_{STG}	-55 to +150	°C
Operating Junction Temperature Range	T_J	-55 to +150	°C

Thermal Characteristics

Parameter	Symbol	Typ.	Max.	Unit
Thermal Resistance Junction to Ambient	$R_{\theta JA}$	---	60	°C/W

Electrical Characteristics ($T_J=25^\circ\text{C}$ unless otherwise specified)

Parameter	Symbol	Conditions	Min.	Typ.	Max.	Unit
Off Characteristics						
Drain-Source Breakdown Voltage	BV_{DSS}	$V_{GS}=0V, I_b=250\mu A$	30	---	---	V
BV_{DSS} Temperature Coefficient	$\Delta BV_{DSS}/\Delta T_J$	Reference to $25^\circ\text{C}, I_b=1\text{mA}$	---	0.04	---	$V/^\circ\text{C}$
Drain-Source Leakage Current	I_{DSS}	$V_{DS}=30V, V_{GS}=0V, T_J=25^\circ\text{C}$	---	---	1	μA
		$V_{DS}=30V, V_{GS}=0V, T_J=125^\circ\text{C}$	---	---	10	μA
Gate-Source Leakage Current	I_{GSS}	$V_{GS}=\pm 20V, V_{DS}=0V$	---	---	± 100	nA
On Characteristics						
Static Drain-Source On-Resistance	$R_{DS(ON)}$	$V_{GS}=10V, I_b=10A$	---	9.5	12	m Ω
		$V_{GS}=4.5V, I_b=5A$	---	13	18	m Ω
Gate Threshold Voltage	$V_{GS(th)}$	$V_{GS}=V_{DS}, I_D=250\mu A$	1.2	1.8	2.5	V
$V_{GS(th)}$ Temperature Coefficient	$\Delta V_{GS(th)}$		---	-4	---	$\text{mV}/^\circ\text{C}$
Forward Transconductance	g_{fs}	$V_{DS}=10V, I_b=3A$	---	6	---	S
Dynamic and Switching Characteristics						
Total Gate Charge ^{3,4}	Q_g	$V_{DS}=15V, V_{GS}=4.5V, I_b=5A$	---	7.4	12	nC
Gate-Source Charge ^{3,4}	Q_{gs}		---	2.3	5	
Gate-Drain Charge ^{3,4}	Q_{gd}		---	3	6	
Turn-On Delay Time ^{3,4}	$T_{d(on)}$	$V_{DD}=15V, V_{GS}=10V, R_G=6\Omega, I_b=1A$	---	3.8	7	nS
Rise Time ^{3,4}	T_r		---	10	19	
Turn-Off Delay Time ^{3,4}	$T_{d(off)}$		---	22	42	
Fall Time ^{3,4}	T_f		---	6.6	13	
Input Capacitance	C_{iss}	$V_{DS}=25V, V_{GS}=0V, F=1\text{MHz}$	---	620	900	pF
Output Capacitance	C_{oss}		---	85	125	
Reverse Transfer Capacitance	C_{rss}		---	60	90	
Gate Resistance	R_g	$V_{GS}=0V, V_{DS}=0V, F=1\text{MHz}$	---	2.8	5.6	Ω
Drain-Source Diode Characteristics and Maximum Ratings						
Parameter	Symbol	Conditions	Min.	Typ.	Max.	Unit
Continuous Source Current	I_S	$V_G=V_D=0V, \text{Force Current}$	---	---	10	A
Pulsed Source Current	I_{SM}		---	---	40	A
Diode Forward Voltage	V_{SD}	$V_{GS}=0V, I_S=1A, T_J=25^\circ\text{C}$	---	---	1	V

Note:

1. Repetitive Rating: Pulsed width limited by maximum junction temperature.
2. $V_{DD}=25V, V_{GS}=10V, L=0.1\text{mH}, I_{AS}=16A, R_G=25\Omega, \text{Starting } T_J=25^\circ\text{C}$.
3. The data tested by pulsed, pulse width $\leq 300\mu\text{s}$, duty cycle $\leq 2\%$.
4. Essentially independent of operating temperature.

Typical Electrical and Thermal Characteristic Curves

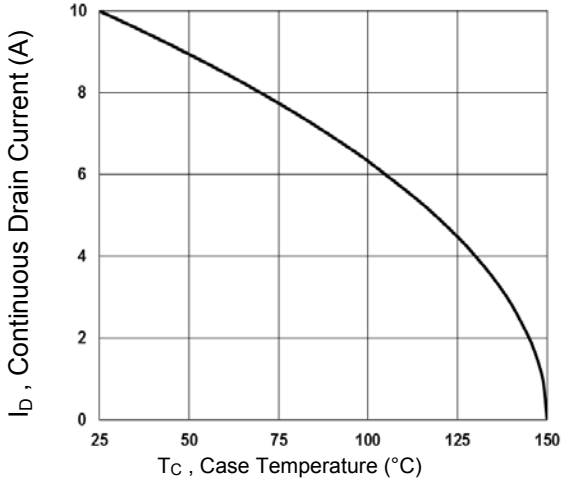

Fig.1 Continuous Drain Current vs. T_c

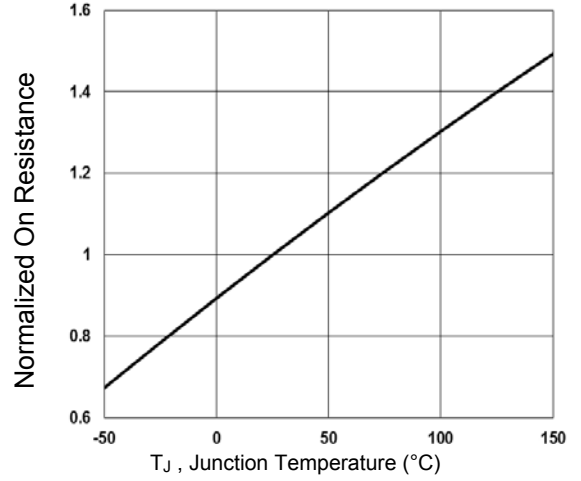

Fig.2 Normalized R_{DS(ON)} vs. T_j

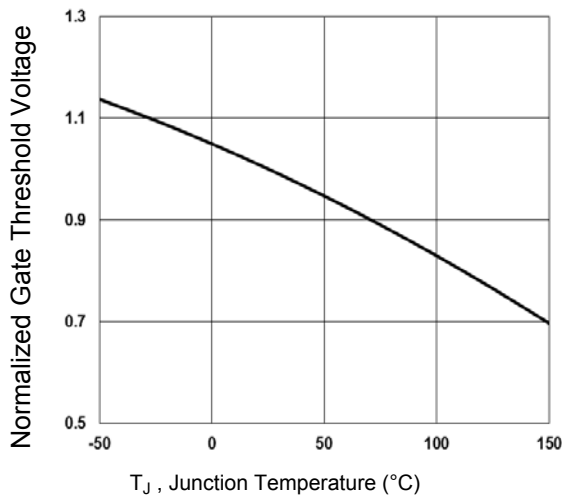

Fig.3 Normalized V_{th} vs. T_j

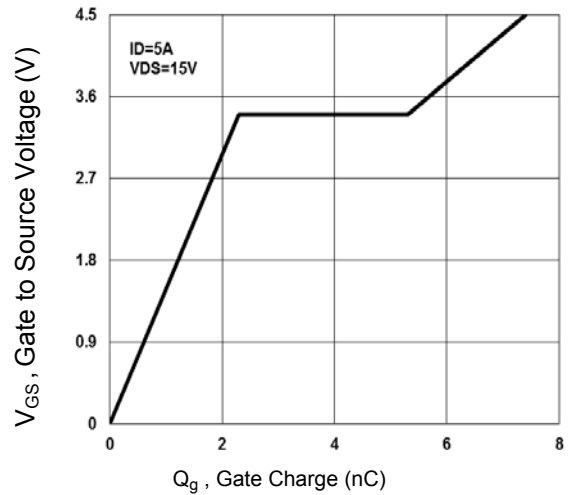

Fig.4 Gate Charge Waveform

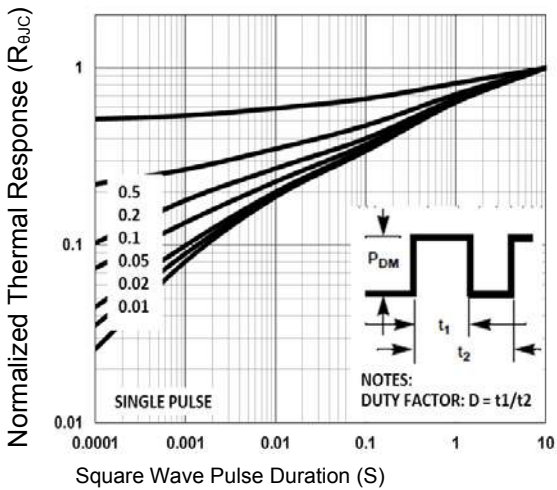

Fig.5 Normalized Transient Impedance

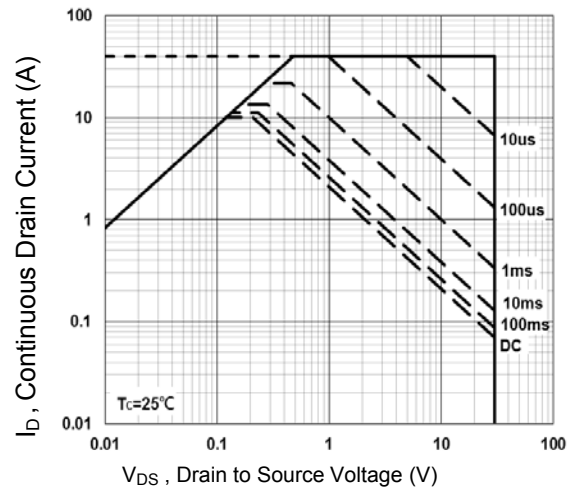

Fig.6 Maximum Safe Operation Area

Typical Electrical and Thermal Characteristic Curves

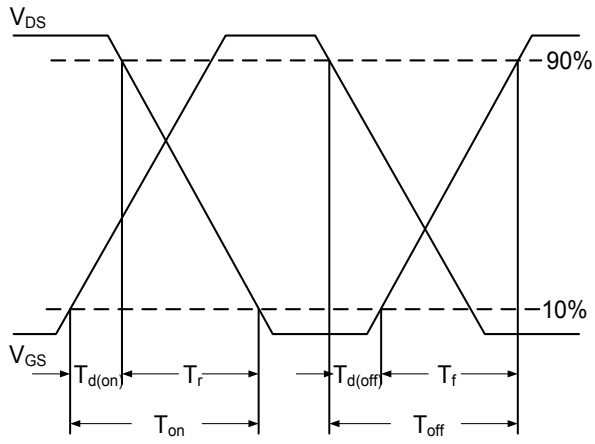

Fig.7 Switching Time Waveform

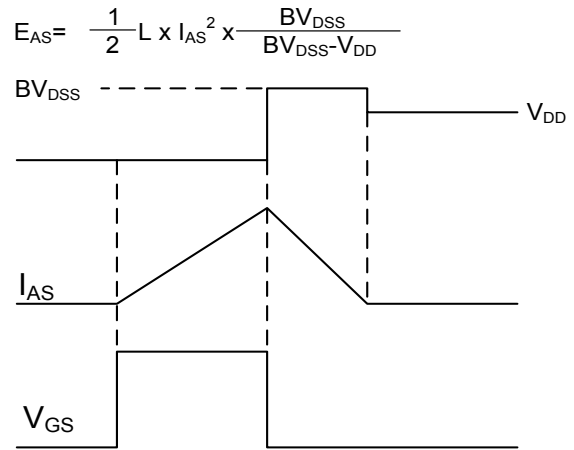
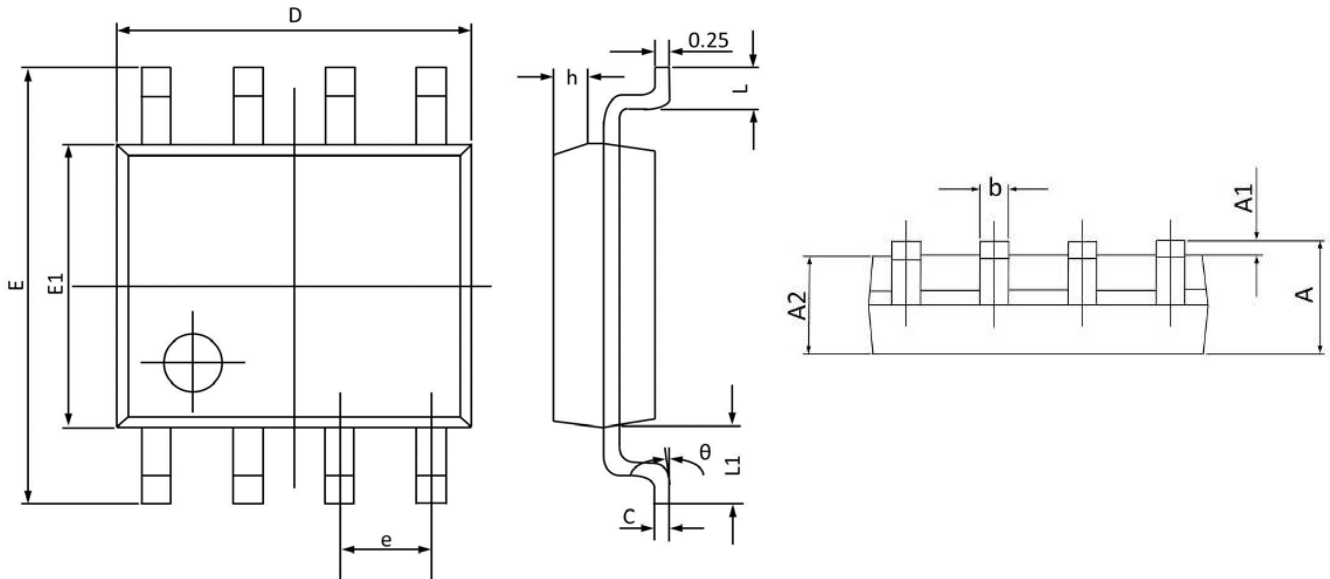

Fig.8 E_{AS} Waveform

Package Outline Dimensions

SOP-8



Symbol	Dimensions In Millimeters		Dimensions In Inches	
	Min	Max	Min	Max
A	1.350	1.750	0.053	0.068
A1	0.100	0.250	0.004	0.009
A2	1.300	1.500	0.052	0.059
A3	0.600	0.700	0.024	0.027
b	0.390	0.480	0.016	0.018
c	0.210	0.260	0.009	0.010
D	4.700	5.100	0.186	0.200
E	5.800	6.200	0.229	0.244
E1	3.700	4.100	0.146	0.161
e	1.270(BSC)		0.050(BSC)	
h	0.250	0.500	0.010	0.019
L	0.500	0.800	0.019	0.031
L1	1.050(BSC)		0.041(BSC)	
θ	0°	8°	0°	8°

Order Information

Device	Package	Marking Code	Carrier	Quantity	HSF Status
SSFQ3910	SOP-8	DS3910	Tape & Reel	3,000/Reel	RoHS Compliant