

DC/DC regulator

Input 8.3 - 16 V

Output 16 A

Contents

Product Program	2
Mechanical Data	2
Connections	2
Absolute Maximum Ratings	3
Input	3
Product Qualification Specification	4
Safety Specification	5
Adjusted to 1.0 Vout - Data	6
Adjusted to 1.2 Vout - Data	9
Adjusted to 1.5 Vout - Data	12
Adjusted to 1.8 Vout - Data	15
Adjusted to 2.5 Vout - Data	18
Adjusted to 3.3 Vout - Data	21
Adjusted to 5.0 Vout - Data	24
EMC Specification	27
Operating Information	28
Thermal Considerations	30
Soldering Information	31
Sales Offices and Contact Information	32

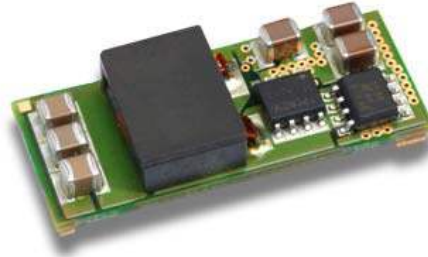

Key Features

- Wide input, 8.3 - 16 Vdc
- Programmable output, 0.75 - 5.5 Vdc
- Monotonic start up into pre-biased output
- Under voltage protection
- Short circuit protection
- Remote sense
- Remote On/Off
- Design for Environment (DfE)
- European Commission Directive 2002/95/EC (RoHs) compliant

The PMC series of surface mount DC/DC regulators (POL) are intended to be used as local distributed power sources in distributed power architecture. The high efficiency and high reliability of the PMC series makes them particularly suited for the communications equipment of today and tomorrow. These products are manufactured using the most advanced technologies and materials to comply with

environmental requirements. Designed to meet high reliability requirements of systems manufacturers, the PMC responds to world-class specifications.

Flex Power Modules is an ISO 9001/14001 certified supplier.

Product Program

V _I	V _O /I _O max	P _O max	Ordering No.	Comment
	Output 1			
8.3 - 16V	0.75 - 5.50/16 A	80 W	PMC 8818T S	Released
8.3 - 16V	1.0 V/16 A	16 W	PMC 8118NA S	On request
	1.2 V/16 A	19.2 W	PMC 8118LA S	On request
	1.5 V/16 A	24 W	PMC 8218H S	On request
	1.8 V/10 A	28.8 W	PMC 8218G S	On request
	2.5 V/10 A	40 W	PMC 8419 S	On request
	3.3 V/16 A	52.8 W	PMC 8510 S	On request
	5 V/16 A	80 W	PMC 8811 S	On request
Option		Suffix	Example	
Negative Remote Control logic		N	PMC 8818T SN	

Mechanical Data

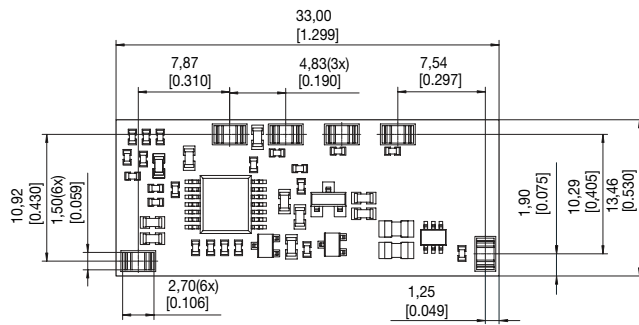

Bottom View

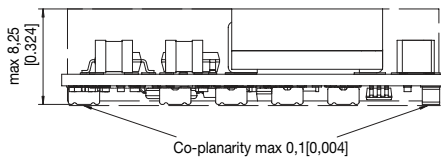

Dimensions in mm[inch]
Tolerances (unless specified):
x,xx ±0,25[0,01]
Pin true position within 0,4[0,016]

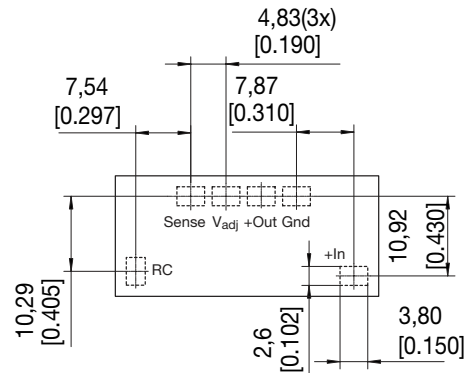
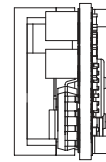

Recommended footprint.
Top View

Connections

Pin	Designation	Function
1	RC	Remote Control
2	+ In	Input Voltage
3	Gnd	Ground
4	+ Out	Output Voltage
5	Vadj	Output Voltage Adjust
6	+ S	Remote sensing

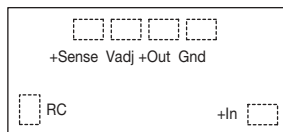

Weight

7 g

Pins

Material: Copper
Plating: Flash gold over nickel

Absolute Maximum Ratings

Characteristics		min	typ	max	Unit
T_{ref}	Maximum Operating Temperature, see thermal considerations	-45		+115	°C
T_S	Storage temperature	-55		+125	°C
V_I	Input voltage	-0.3		16	Vdc
V_{tr}	Input voltage transient	-0.3		40	Vdc
V_{RC}	Remote control voltage	Negative logic		16	Vdc
		Positive logic	-0.3	16	Vdc

Stress in excess of Absolute Maximum Ratings may cause permanent damage. Absolute Maximum Ratings, sometimes referred to as no destruction limits, are normally tested with one parameter at a time exceeding the limits of Output data or Electrical Characteristics. If exposed to stress above these limits, function and performance may degrade in an unspecified manner.

Input

$T_{ref} = -30 \dots +90 \text{ °C}$, $V_I = 8.3 \dots 16.0 \text{ V}$ unless otherwise specified
 Typ values specified at: $T_{ref} = +25 \text{ °C}$, V_{Inom} , $I_o \text{ max} = 16 \text{ A}$

Characteristics		Conditions	min	typ	max	Unit
V_I	Input voltage range		8.3	12	16	V
V_{loff}	Turn-off input voltage	$I_o \text{ max}$		7.8		V
V_{lon}	Turn-on input voltage	$I_o \text{ max}$		8.0		V
C_I	Input capacitance			30		μF
P_{II}	Input idling power $I_o = 0 \text{ A}$, $V_I = 12 \text{ V}$	$V_o = 1.00 \text{ V}$		470	560	mW
		$V_o = 1.20 \text{ V}$		500	600	mW
		$V_o = 1.50 \text{ V}$		550	660	mW
		$V_o = 1.80 \text{ V}$		605	725	mW
		$V_o = 2.50 \text{ V}$		750	900	mW
		$V_o = 3.30 \text{ V}$		910	1090	mW
		$V_o = 5.00 \text{ V}$		1150	1410	mW
P_{RC}	Input stand-by power	$V_I = 12 \text{ V}$, RC activated		35		mW
V_{iac}	Input ripple 1) 20 Hz ... 5 MHz $V_I = 12 \text{ V}$, $I_o = 1.0 \times I_o \text{ max}$	$V_o = 1.00 \text{ V}$		170		mV _{p-p}
		$V_o = 1.20 \text{ V}$		180		mV _{p-p}
		$V_o = 1.50 \text{ V}$		190		mV _{p-p}
		$V_o = 1.80 \text{ V}$		210		mV _{p-p}
		$V_o = 2.50 \text{ V}$		310		mV _{p-p}
		$V_o = 3.30 \text{ V}$		350		mV _{p-p}
		$V_o = 5.00 \text{ V}$		540		mV _{p-p}

1) Measured with 4 x 4.7 μF ceramic capacitors

Fundamental Circuit Diagram

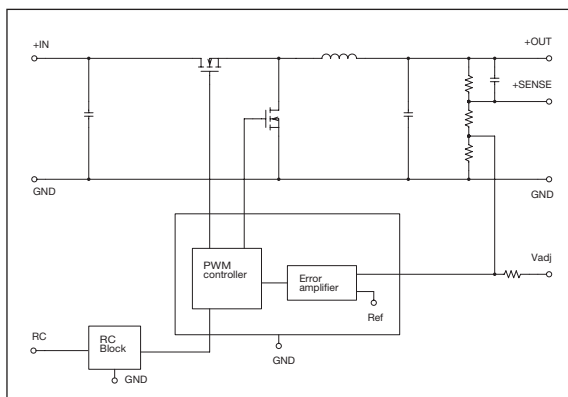

Product Qualification Specification

Characteristics			
Random Vibration	JESD 22-B103-B	Frequency Acceleration density	2 ... 500 Hz 0.008 ... 0.2 g ² /Hz
Sinusoidal vibration	JESD 22-B103-B	Frequency Acceleration	10 ... 1000 Hz 10 g
Mechanical shock (half sinus)	JESD 22-B104-B	Peak acceleration Duration	200 g 1.5 ms
Lead integrity	JESD 22-B105-C	Weight of 1000 g	All terminals
Temperature cycling	JESD 22-A104-B	Temperature Number of cycles	-40 ... +125 °C 300
Accelerated damp heat	JESD 22-A101-B	Temperature Humidity Duration Bias	+85 °C 85 % RH 1000 hours max input voltage
Solderability	IEC 60068-2-54 (Aged according to JESD 22- A101-B, 240h no bias)	Solder immersion depth Time for onset of wetting Wetting force	1 mm < 4 s > 100 mN/m
Cold (in operation)	IEC 60068-2-1A, test A _d	Temperature Duration	-45 °C 72 h
High temperature storage	JESD 22-A103-B	Temperature Duration	+125 °C 1000 h

Safety Specification

General information.

Flex Power Modules DC/DC converters and DC/DC regulators are designed in accordance with safety standards IEC/EN/UL 60 950, *Safety of Information Technology Equipment*.

IEC/EN/UL60950 contains requirements to prevent injury or damage due to the following hazards:

- *Electrical shock*
- *Energy hazards*
- *Fire*
- *Mechanical and heat hazards*
- *Radiation hazards*
- *Chemical hazards*

On-board DC-DC converters are defined as component power supplies. As components they cannot fully comply with the provisions of any Safety requirements without "Conditions of Acceptability". It is the responsibility of the installer to ensure that the final product housing these components complies with the requirements of all applicable Safety standards and Directives for the final product.

Component power supplies for general use should comply with the requirements in IEC60950, EN60950 and UL60950 "Safety of information technology equipment".

There are other more product related standards, e.g. IEC61204-7 "Safety standard for power supplies", IEEE802.3af "Ethernet LAN/MAN Data terminal equipment power", and ETS300132-2 "Power supply interface at the input to telecommunications equipment; part 2: DC", but all of these standards are based on IEC/EN/UL60950 with regards to safety.

Flex Power Modules DC/DC converters and DC/DC regulators are UL 60 950 recognized and certified in accordance with EN 60 950.

The flammability rating for all construction parts of the products meets UL 94V-0.

The products should be installed in the end-use equipment, in accordance with the requirements of the ultimate application. Normally the output of the DC/DC converter is considered as SELV (Safety Extra Low Voltage) and the input source must be isolated by minimum Double or Reinforced Insulation from the primary circuit (AC mains) in accordance with IEC/EN/UL 60 950.

Isolated DC/DC converters.

It is recommended that a fast blow fuse with a rating twice the maximum input current per selected product be used at the input of each DC/DC converter. If an input filter is used in the circuit the fuse should be placed in front of the input filter.

In the rare event of a component problem in the input filter or in the DC/DC converter that imposes a short circuit on the input source, this fuse will provide the following functions:

- Isolate the faulty DC/DC converter from the input power source so as not to affect the operation of other parts of the system.
- Protect the distribution wiring from excessive current and power loss thus preventing hazardous overheating.

The galvanic isolation is verified in an electric strength test. The test voltage (V_{ISO}) between input and output is 1500 Vdc or 2250 Vdc for 60 seconds (refer to product specification). Leakage current is less than 1µA at nominal input voltage.

24 V dc systems.

The input voltage to the DC/DC converter is SELV (Safety Extra Low Voltage) and the output remains SELV under normal and abnormal operating conditions.

48 and 60 V dc systems.

If the input voltage to Flex Power Modules DC/DC converter is 75 V dc or less, then the output remains SELV (Safety Extra Low Voltage) under normal and abnormal operating conditions.

Single fault testing in the input power supply circuit should be performed with the DC/DC converter connected to demonstrate that the input voltage does not exceed 75 V dc.

If the input power source circuit is a DC power system, the source may be treated as a TNV2 circuit and testing has demonstrated compliance with SELV limits and isolation requirements equivalent to Basic Insulation in accordance with IEC/EN/UL 60 950.

Non-isolated DC/DC regulators.

The input voltage to the DC/DC regulator is SELV (Safety Extra Low Voltage) and the output remains SELV under normal and abnormal operating conditions.

It is recommended that a slow blow fuse with a rating twice the maximum input current per selected product be used at the input of each DC/DC regulator.

Adjusted to 1.0 Vout - Data

$T_{ref} = -30 \dots +90 \text{ }^\circ\text{C}$, $V_I = 8.3 \dots 16 \text{ V}$ unless otherwise specified. Input filter $4 \times 4.7 \text{ } \mu\text{F}$, Output filter $2 \times 150 \text{ } \mu\text{F}$

Typ values specified at: $T_{ref} = +25 \text{ }^\circ\text{C}$ and V_{Inom} . $I_{Omax} = 16 \text{ A}$. Note: +Sense connected to +Out. $R_{adj} 41.42 \text{ k}\Omega$

Characteristics		Conditions	Output			Unit
			min	typ	max	
dV_{O_i}	Output voltage adjusted setting	$T_{ref} = +25 \text{ }^\circ\text{C}$, V_{Inom} , I_{Omax}	-2		+2	% V_O
dV_O	Output voltage tolerance band	$I_O = 0.01 \dots 1.0 \times I_{Omax}$	-3		+3	% V_O
dV_O	Idling voltage	$I_O = 0 \text{ A}$	-2		+2	% V_O
dV_O	Line regulation	$V_{Imin} \dots V_{Imax}$, I_{Omax}		2		mV
dV_O	Load regulation	$I_O = 0.01 \dots 1.0 \times I_{Omax}$		25		mV
t_{tr}	Load transient recovery time	Load step = $0.25\text{-}0.75\text{-}0.25 \times I_{Omax}$, $di/dt = 5 \text{ A}/\mu\text{s}$, $C_O = 2 \times 150 \text{ } \mu\text{F}$, $V_I = 12 \text{ V}$		40		μs
V_{tr}	Load transient voltage	$V_I = 12 \text{ V}$		± 100		mV
T_{coeff}	Temperature coefficient	$T_{ref} = -30 \dots +90 \text{ }^\circ\text{C}$, I_{Omax}		-0.6		$\text{mV}/^\circ\text{C}$
t_s	Start-up V_I on to $0.9 \times V_O$	$I_O = I_{Omax}$, V_{Inom}		7		ms
t_r	Ramp-up, $V_I \dots 0.9 \times V_O$	$I_O = I_{Omax}$, V_{Inom}		3		ms
t_f	Fall time, V_I to $0.1 \times V_O$	$I_O = I_{Omax}$, V_{Inom}		1		ms
t_f	Fall time, V_I to $0.1 \times V_O$	$I_O = 0 \text{ A}$, V_{Inom}		22		s
t_{RC}	RC shut-down time $0.1 \times V_O$	$I_O = I_{Omax}$, V_{Inom}		1		ms
t_{RC}	RC start-up time $0.9 \times V_O$	$I_O = I_{Omax}$, V_{Inom}		7		ms
t_{RC}	RC fall time, $0.1 \times V_O$	$I_O = 0 \text{ A}$, V_{Inom}		24		s
I_O	Output current		0		16	A
P_{Omax}	Max output power		16			W
I_{lim}	Current limiting threshold	$T_{ref} < T_{refmax}$	19			A
V_{Oac}	Output ripple	20 Hz ... 5 MHz, I_{Omax}		50		mV_{p-p}
η	Efficiency - 50% load	$I_O = 0.5 \times I_{Omax}$, $V_O = 1.00 \text{ V}$		84.4		%
η	Efficiency - 100% load	$I_O = I_{Omax}$, $V_O = 1.00 \text{ V}$	80.8	83.2		%
P_d	Power Dissipation	$I_O = I_{Omax}$, $V_O = 1.00 \text{ V}$		3.2	3.8	W
F_o	Switching frequency	$I_O = (0 \dots 1) \times I_{Omax}$	260	300	340	kHz
I_{sense}	Remote sense current				10	mA
I_i	Static input current $V_I = 8.3 \text{ V}$	$I_O = I_{Omax}$, $V_O = 1.00 \text{ V}$		2.4		A
MTBF	Predicted reliability			5		million hours

Adjusted to 1.0 Vout - Typical Characteristics

General conditions: Input filter 4 x 4.7 μ F, Output filter 2 x 150 μ F

Efficiency

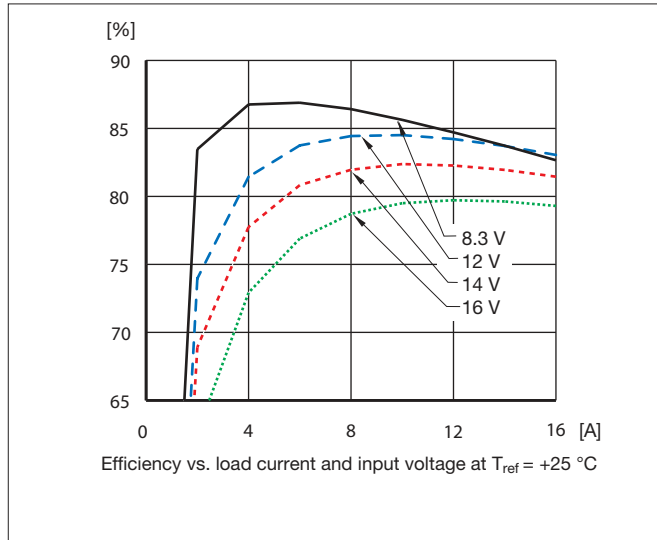

Power Dissipation

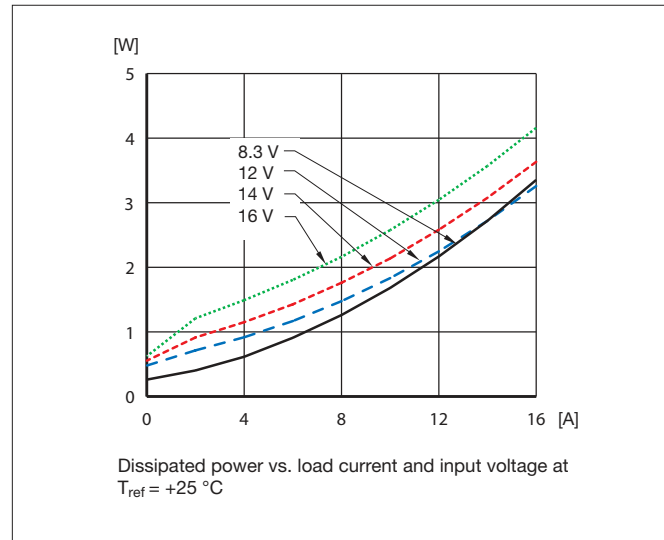

Output Current Derating at 12 V input

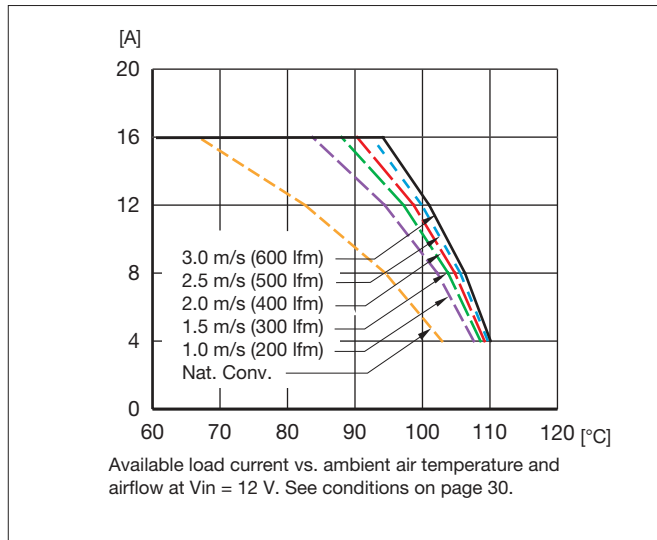

Output Characteristics

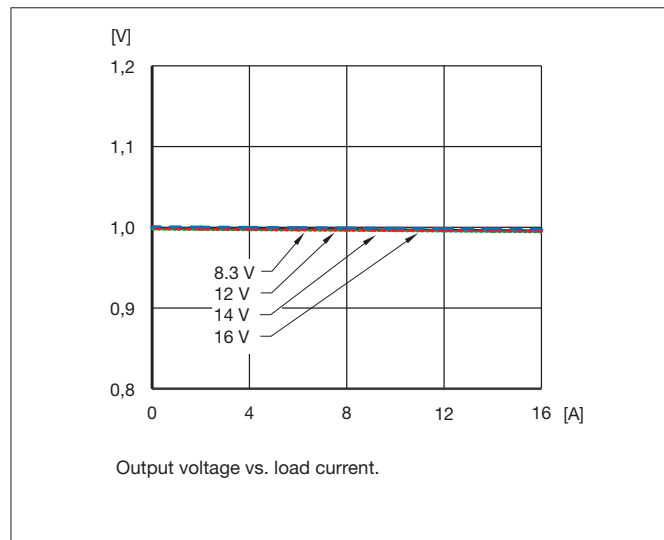

Start-Up

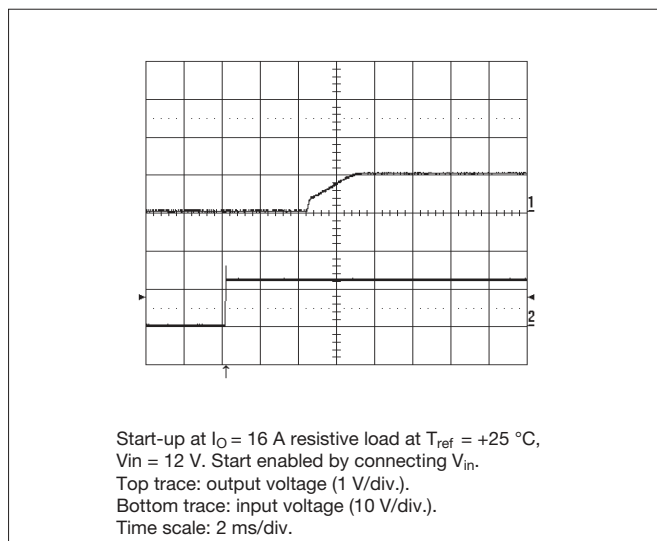

Turn Off

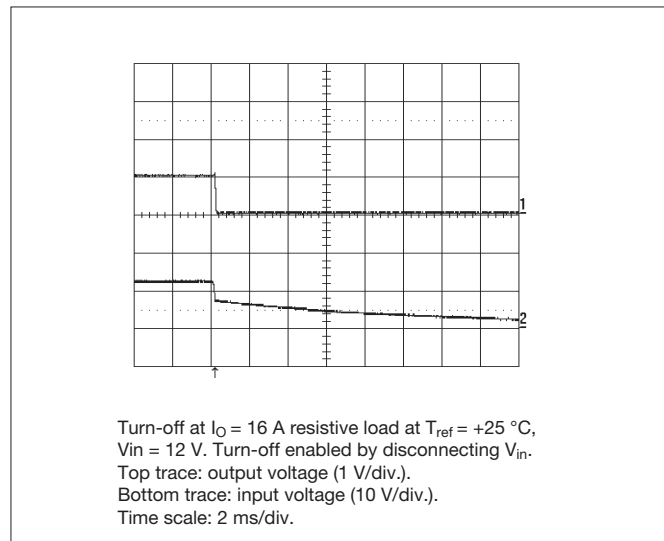

Adjusted to 1.0 Vout - Typical Characteristics

General conditions: Input filter 4 x 4.7 μ F, Output filter 2 x 150 μ F

Output Ripple

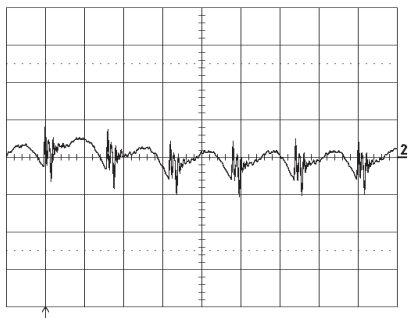

Output voltage ripple (20 mV/div.) at $T_{ref} = +25\text{ }^{\circ}\text{C}$,
 $V_{in} = 12\text{ V}$, $I_O = 16\text{ A}$ resistive load.
Band width = 5 MHz.
Time scale: 2 μ s/div.

Transient

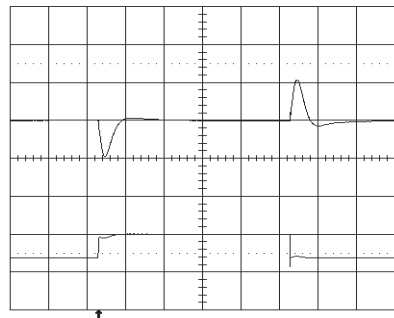

Output voltage response to load current step-change
(4-12-4 A) at $T_{ref} = +25\text{ }^{\circ}\text{C}$, $V_{in} = 12\text{ V}$, $di/dt = 5\text{ A}/\mu\text{s}$
Top trace: output voltage (ac) (100 mV/div.).
Bottom trace: load current (dc) (10 A/div.)
Time scale: 0.1 ms/div.

Adjusted to 1.2 Vout - Data

$T_{ref} = -30 \dots +90 \text{ }^\circ\text{C}$, $V_I = 8.3 \dots 16 \text{ V}$ unless otherwise specified. Input filter $4 \times 4.7 \text{ } \mu\text{F}$, Output filter $2 \times 150 \text{ } \mu\text{F}$

Typ values specified at: $T_{ref} = +25 \text{ }^\circ\text{C}$ and V_{Inom} , $I_{Omax} = 16 \text{ A}$. Note: +Sense connected to +Out. $R_{adj} 22.46 \text{ k}\Omega$

Characteristics		Conditions	Output			Unit
			min	typ	max	
dV_{Oi}	Output voltage adjusted setting	$T_{ref} = +25 \text{ }^\circ\text{C}$, V_{Inom} , I_{Omax}	-2		+2	% V_O
dV_O	Output voltage tolerance band	$I_O = 0.01 \dots 1.0 \times I_{Omax}$	-3		+3	% V_O
dV_O	Idling voltage	$I_O = 0 \text{ A}$	-2		+2	% V_O
dV_O	Line regulation	$V_{Imin} \dots V_{Imax}$, I_{Omax}		2		mV
dV_O	Load regulation	$I_O = 0.01 \dots 1.0 \times I_{Omax}$		25		mV
t_{tr}	Load transient recovery time	Load step = $0.25-0.75-0.25 \times I_{Omax}$, $di/dt = 5 \text{ A}/\mu\text{s}$, $C_O = 2 \times 150 \text{ } \mu\text{F}$, $V_I = 12 \text{ V}$		40		μs
V_{tr}	Load transient voltage	$V_I = 12 \text{ V}$		± 100		mV
T_{coeff}	Temperature coefficient	$T_{ref} = -30 \dots +90 \text{ }^\circ\text{C}$, I_{Omax}		-0.6		$\text{mV}/^\circ\text{C}$
t_s	Start-up V_I on to $0.9 \times V_O$	$I_O = I_{Omax}$, V_{Inom}		7		ms
t_r	Ramp-up, $V_I \dots 0.9 \times V_O$	$I_O = I_{Omax}$, V_{Inom}		3		ms
t_f	Fall time, V_I to $0.1 \times V_O$	$I_O = I_{Omax}$, V_{Inom}		1		ms
t_f	Fall time, V_I to $0.1 \times V_O$	$I_O = 0 \text{ A}$, V_{Inom}		21		s
t_{RC}	RC shut-down time $0.1 \times V_O$	$I_O = I_{Omax}$, V_{Inom}		1		ms
t_{RC}	RC start-up time $0.9 \times V_O$	$I_O = I_{Omax}$, V_{Inom}		7		ms
t_{RC}	RC fall time, $0.1 \times V_O$	$I_O = 0 \text{ A}$, V_{Inom}		21		s
I_O	Output current		0		16	A
P_{Omax}	Max output power		19.2			W
I_{lim}	Current limiting threshold	$T_{ref} < T_{refmax}$	19			A
V_{Oac}	Output ripple	20 Hz ... 5 MHz, I_{Omax}		50		mV_{p-p}
η	Efficiency - 50% load	$I_O = 0.5 \times I_{Omax}$, $V_O = 1.20 \text{ V}$		86.5		%
η	Efficiency - 100% load	$I_O = I_{Omax}$, $V_O = 1.20 \text{ V}$	81.5	85.4		%
P_d	Power Dissipation	$I_O = I_{Omax}$, $V_O = 1.20 \text{ V}$		3.3	4.4	W
F_o	Switching frequency	$I_O = (0 \dots 1) \times I_{Omax}$	260	300	340	kHz
I_{sense}	Remote sense current				10	mA
I_i	Static input current $V_I = 8.3 \text{ V}$	$I_O = I_{Omax}$, $V_O = 1.20 \text{ V}$		2.8		A
MTBF	Predicted reliability			5		million hours

Adjusted to 1.2 Vout - Typical Characteristics

General conditions: Input filter 4 x 4.7 μ F, Output filter 2 x 150 μ F

Efficiency

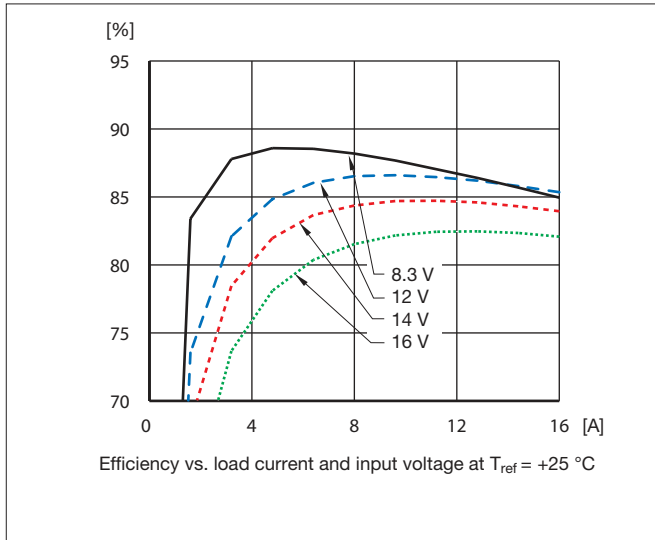

Power Dissipation

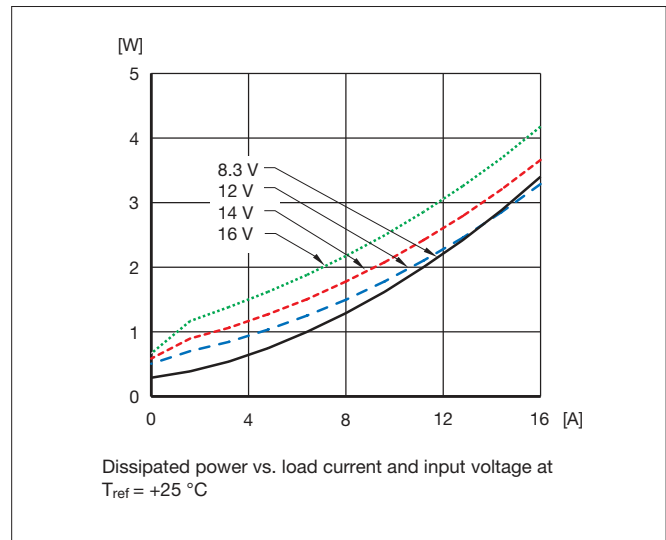

Output Current Derating at 12 V input

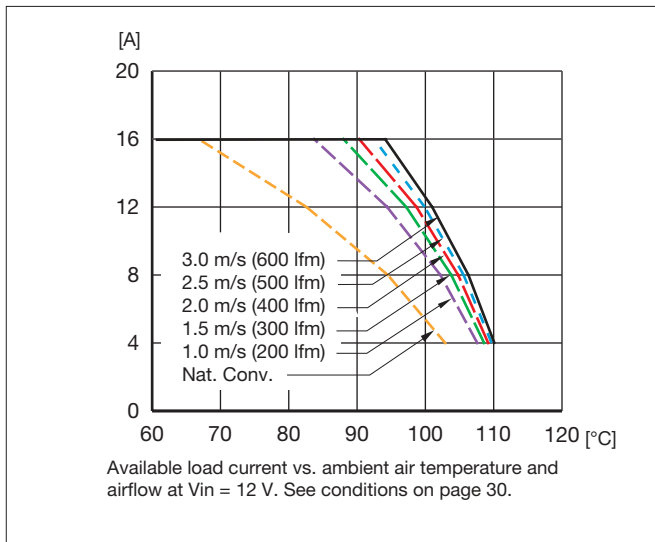

Output Characteristic

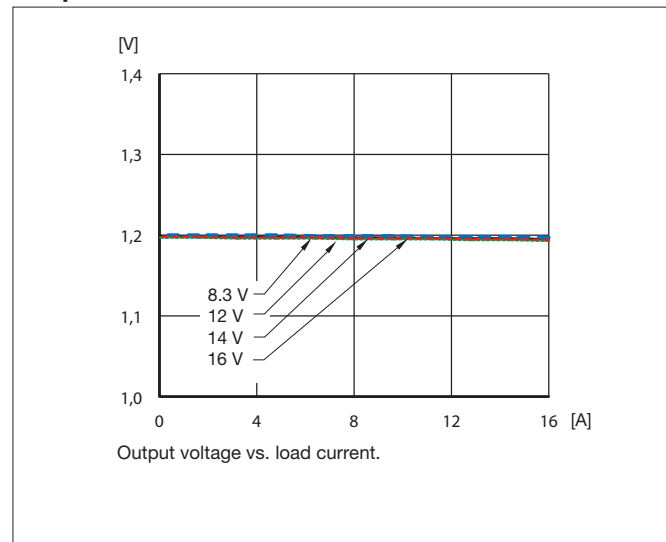

Start-Up

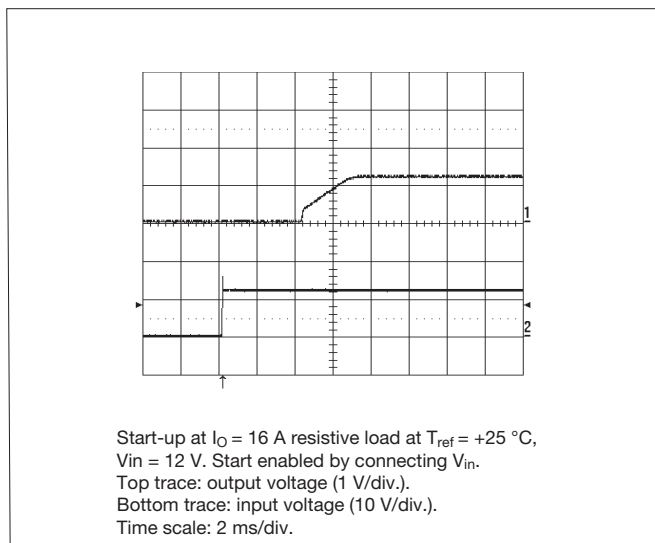

Turn Off

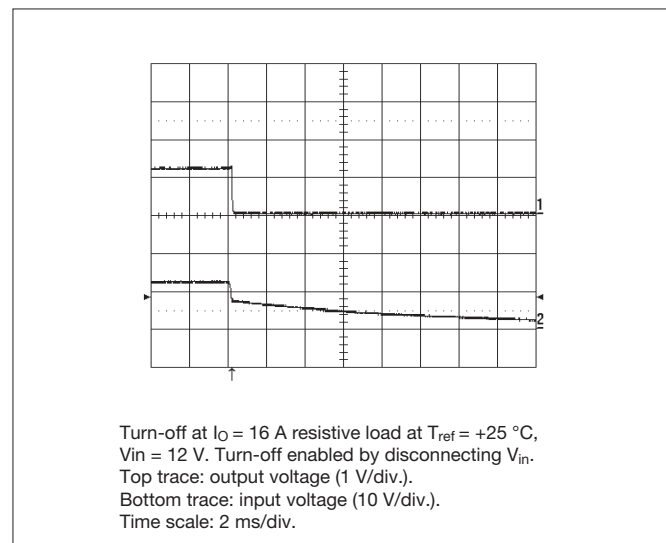

Adjusted to 1.2 Vout - Typical Characteristics

General conditions: Input filter 4 x 4.7 μ F, Output filter 2 x 150 μ F

Output Ripple

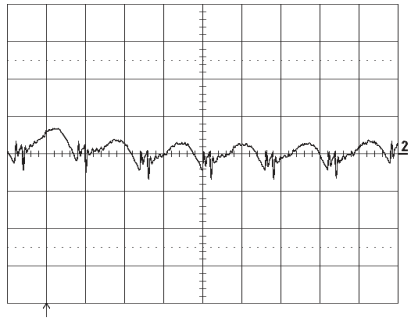

Output voltage ripple (20 mV/div.) at $T_{ref} = +25\text{ }^{\circ}\text{C}$,
 $V_{in} = 12\text{ V}$, $I_O = 16\text{ A}$ resistive load.
Band width = 5 MHz.
Time scale: 2 μ s/div.

Transient

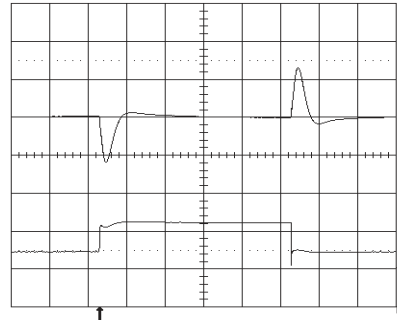

Output voltage response to load current step-change
(4-12-4 A) at $T_{ref} = +25\text{ }^{\circ}\text{C}$, $V_{in} = 12\text{ V}$. $dI/dt = 5\text{ A}/\mu\text{s}$
Top trace: output voltage (ac) (100 mV/div.).
Bottom trace: load current (dc) (10 A/div.)
Time scale: 0.1 ms/div.

Adjusted to 1.5 Vout - Data

$T_{ref} = -30 \dots +90 \text{ }^\circ\text{C}$, $V_I = 8.3 \dots 16 \text{ V}$ unless otherwise specified. Input filter $4 \times 4.7 \text{ } \mu\text{F}$, Output filter $2 \times 150 \text{ } \mu\text{F}$

Typ values specified at: $T_{ref} = +25 \text{ }^\circ\text{C}$ and V_{Inom} . $I_{Omax} = 16 \text{ A}$. Note: +Sense connected to +Out. $R_{adj} 13.05 \text{ k}\Omega$

Characteristics		Conditions	Output			Unit
			min	typ	max	
dV_{O_i}	Output voltage adjusted setting	$T_{ref} = +25 \text{ }^\circ\text{C}$, V_{Inom} , I_{Omax}	-2		+2	% V_O
dV_O	Output voltage tolerance band	$I_O = 0.01 \dots 1.0 \times I_{Omax}$	-3		+3	% V_O
dV_O	Idling voltage	$I_O = 0 \text{ A}$	-2		+2	% V_O
dV_O	Line regulation	$V_{Imin} \dots V_{Imax}$, I_{Omax}		2		mV
dV_O	Load regulation	$I_O = 0.01 \dots 1.0 \times I_{Omax}$		25		mV
t_{tr}	Load transient recovery time	Load step = $0.25\text{-}0.75\text{-}0.25 \times I_{Omax}$, $di/dt = 5 \text{ A}/\mu\text{s}$, $C_O = 2 \times 150 \text{ } \mu\text{F}$, $V_I = 12 \text{ V}$		40		μs
V_{tr}	Load transient voltage			± 100		mV
T_{coeff}	Temperature coefficient	$T_{ref} = -30 \dots +90 \text{ }^\circ\text{C}$, I_{Omax}		-0.6		$\text{mV}/^\circ\text{C}$
t_s	Start-up V_I on to $0.9 \times V_O$	$I_O = I_{Omax}$, V_{Inom}		7		ms
t_r	Ramp-up, $V_I \dots 0.9 \times V_O$	$I_O = I_{Omax}$, V_{Inom}		3		ms
t_f	Fall time, V_I to $0.1 \times V_O$	$I_O = I_{Omax}$, V_{Inom}		1		ms
t_f	Fall time, V_I to $0.1 \times V_O$	$I_O = 0 \text{ A}$, V_{Inom}		20		s
t_{RC}	RC shut-down time $0.1 \times V_O$	$I_O = I_{Omax}$, V_{Inom}		1		ms
t_{RC}	RC start-up time $0.9 \times V_O$	$I_O = I_{Omax}$, V_{Inom}		7		ms
t_{RC}	RC fall time, $0.1 \times V_O$	$I_O = 0 \text{ A}$, V_{Inom}		20		s
I_O	Output current		0		16	A
P_{Omax}	Max output power		24			W
I_{lim}	Current limiting threshold	$T_{ref} < T_{refmax}$	19			A
V_{Oac}	Output ripple	20 Hz ... 5 MHz, I_{Omax}		50		mV_{p-p}
η	Efficiency - 50% load	$I_O = 0.5 \times I_{Omax}$, $V_O = 1.50 \text{ V}$		88.5		%
η	Efficiency - 100% load	$I_O = I_{Omax}$, $V_O = 1.50 \text{ V}$	84.2	87.6		%
P_d	Power Dissipation	$I_O = I_{Omax}$, $V_O = 1.50 \text{ V}$		3.4	4.5	W
F_o	Switching frequency	$I_O = (0 \dots 1) \times I_{Omax}$	260	300	340	kHz
I_{sense}	Remote sense current				10	mA
I_i	Static input current $V_I = 8.3 \text{ V}$	$I_O = I_{Omax}$, $V_O = 1.50 \text{ V}$		3.4		A
MTBF	Predicted reliability			5		million hours

Adjusted to 1.5 Vout - Typical Characteristics

General conditions: Input filter 4 x 4.7 μ F, Output filter 2 x 150 μ F

Efficiency

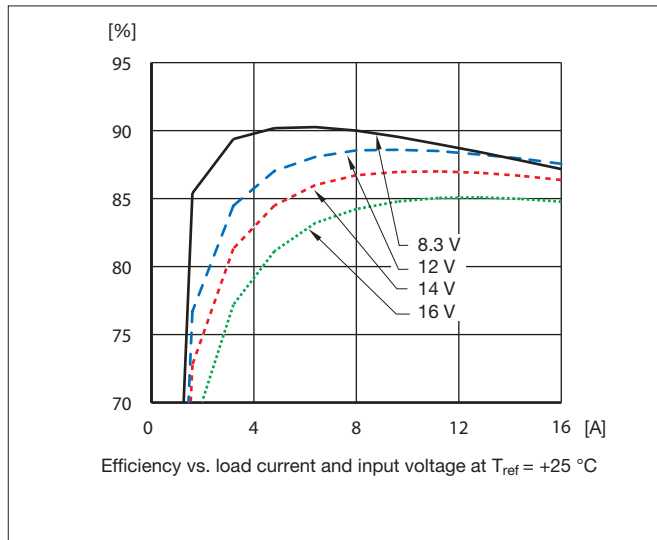

Power Dissipation

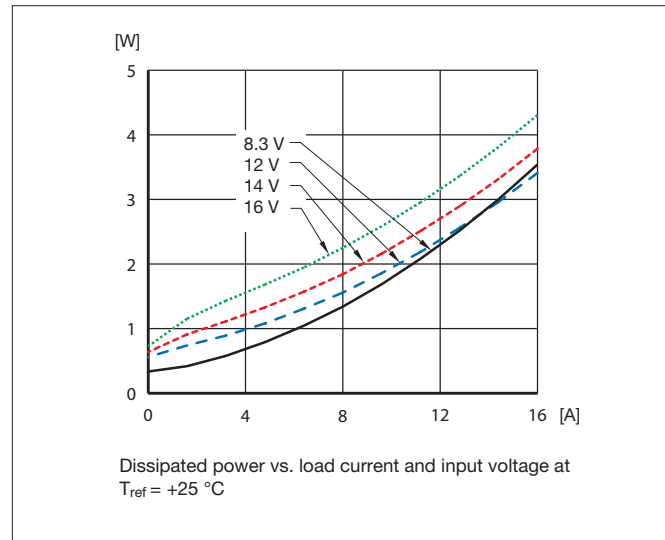

Output Current Derating at 12 V input

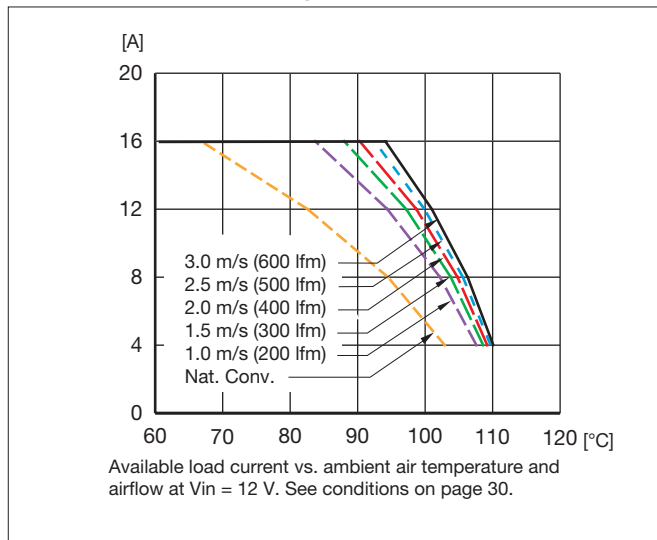

Output Characteristic

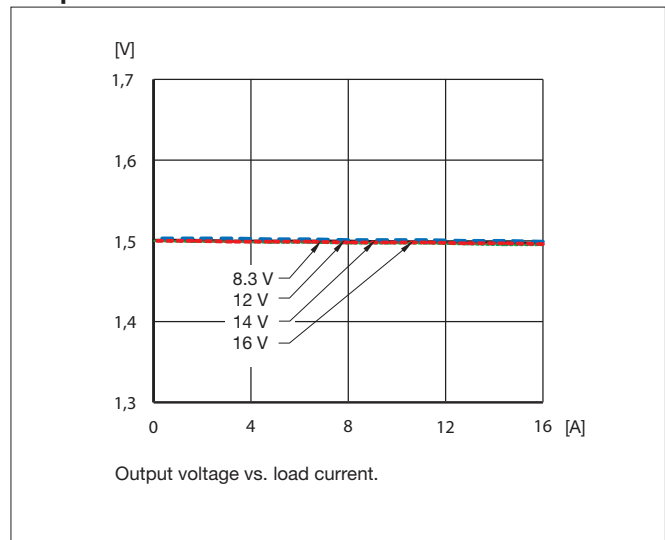

Start-Up

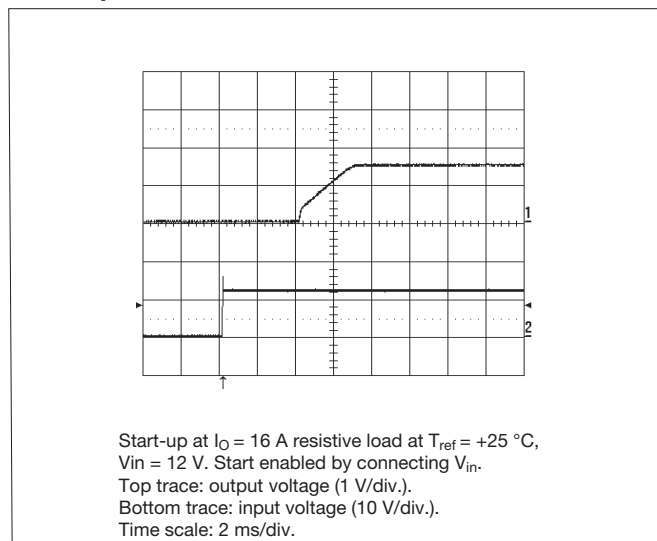

Turn Off

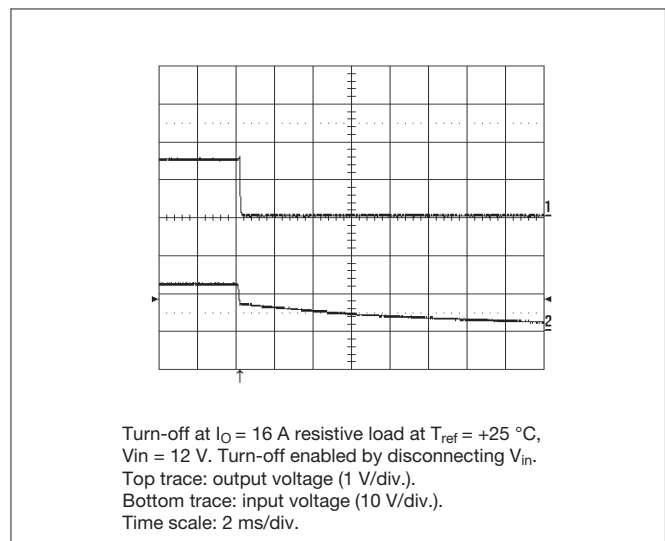

Adjusted to 1.5 Vout - Typical Characteristics

General conditions: Input filter 4 x 4.7 μ F, Output filter 2 x 150 μ F

Output Ripple

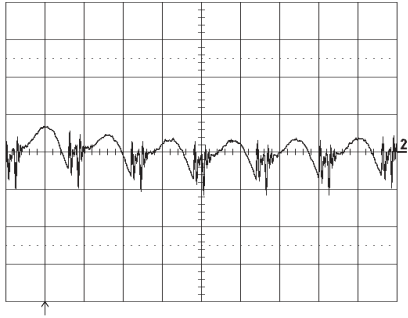

Output voltage ripple (20 mV/div.) at $T_{ref} = +25\text{ }^{\circ}\text{C}$,
 $V_{in} = 12\text{ V}$, $I_O = 16\text{ A}$ resistive load.
Band width = 5 MHz.
Time scale: 2 μ s/div.

Transient

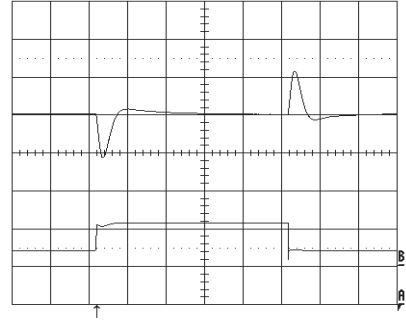

Output voltage response to load current step-change
(4-12-4 A) at $T_{ref} = +25\text{ }^{\circ}\text{C}$, $V_{in} = 12\text{ V}$, $dl/dt = 5\text{ A}/\mu\text{s}$
Top trace: output voltage (ac) (100 mV/div.)
Bottom trace: load current (dc) (10 A/div.)
Time scale: 0.1 ms/div.

Adjusted to 1.8 Vout - Data

$T_{ref} = -30 \dots +90 \text{ }^\circ\text{C}$, $V_I = 8.3 \dots 16 \text{ V}$ unless otherwise specified. Input filter $4 \times 4.7 \text{ } \mu\text{F}$, Output filter $2 \times 150 \text{ } \mu\text{F}$

Typ values specified at: $T_{ref} = +25 \text{ }^\circ\text{C}$ and V_{Inom} . $I_{Omax} = 16 \text{ A}$. Note: +Sense connected to +Out. $R_{adj} 9.024 \text{ k}\Omega$

Characteristics		Conditions	Output			Unit
			min	typ	max	
dV _{Oi}	Output voltage adjusted setting	$T_{ref} = +25 \text{ }^\circ\text{C}$, V_{Inom} , I_{Omax}	-2		+2	% V _O
dV _O	Output voltage tolerance band	$I_O = 0.01 \dots 1.0 \times I_{Omax}$	-3		+3	% V _O
dV _O	Idling voltage	$I_O = 0 \text{ A}$	-2		+2	% V _O
dV _O	Line regulation	$V_{Imin} \dots V_{Imax}$, I_{Omax}		2		mV
dV _O	Load regulation	$I_O = 0.01 \dots 1.0 \times I_{Omax}$		25		mV
t _{tr}	Load transient recovery time	Load step = $0.25-0.75-0.25 \times I_{Omax}$, $di/dt = 5 \text{ A}/\mu\text{s}$, $C_O = 2 \times 150 \text{ } \mu\text{F}$, $V_I = 12 \text{ V}$		40		μs
V _{tr}	Load transient voltage	$V_I = 12 \text{ V}$		± 100		mV
T _{coeff}	Temperature coefficient	$T_{ref} = -30 \dots +90 \text{ }^\circ\text{C}$, I_{Omax}		-0.6		mV/°C
t _s	Start-up V_I on to $0.9 \times V_O$	$I_O = I_{Omax}$, V_{Inom}		7		ms
t _r	Ramp-up, $V_I \dots 0.9 \times V_O$	$I_O = I_{Omax}$, V_{Inom}		3		ms
t _f	Fall time, V_I to $0.1 \times V_O$	$I_O = I_{Omax}$, V_{Inom}		1		ms
t _f	Fall time, V_I to $0.1 \times V_O$	$I_O = 0 \text{ A}$, V_{Inom}		18		s
t _{RC}	RC shut-down time $0.1 \times V_O$	$I_O = I_{Omax}$, V_{Inom}		1		ms
t _{RC}	RC start-up time $0.9 \times V_O$	$I_O = I_{Omax}$, V_{Inom}		7		ms
t _{RC}	RC fall time, $0.1 \times V_O$	$I_O = 0 \text{ A}$, V_{Inom}		18		s
I _O	Output current		0		16	A
P _{Omax}	Max output power		28.8			W
I _{lim}	Current limiting threshold	$T_{ref} < T_{refmax}$	19			A
V _{Oac}	Output ripple	20 Hz ... 5 MHz, I_{Omax}		50		mV _{p-p}
η	Efficiency - 50% load	$I_O = 0.5 \times I_{Omax}$, $V_O = 1.80 \text{ V}$		89.9		%
η	Efficiency - 100% load	$I_O = I_{Omax}$, $V_O = 1.80 \text{ V}$	86.1	89.1		%
P _d	Power Dissipation	$I_O = I_{Omax}$, $V_O = 1.80 \text{ V}$		3.5	4.6	W
F _o	Switching frequency	$I_O = (0 \dots 1) \times I_{Omax}$	260	300	340	kHz
I _{sense}	Remote sense current				10	mA
I _I	Static input current $V_I = 8.3 \text{ V}$	$I_O = I_{Omax}$, $V_O = 1.80 \text{ V}$		4.0		A
MTBF	Predicted reliability			5		million hours

Adjusted to 1.8 Vout - Typical Characteristics

General conditions: Input filter 4 x 4.7 μ F, Output filter 2 x 150 μ F

Efficiency

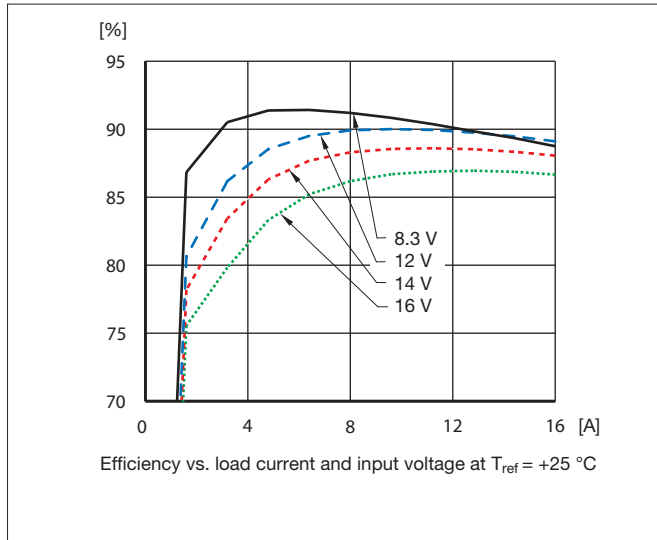

Power Dissipation

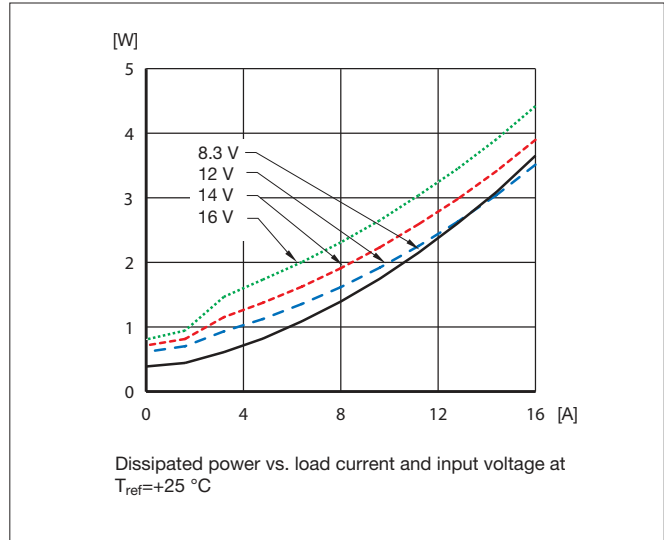

Output Current Derating at 12 V input

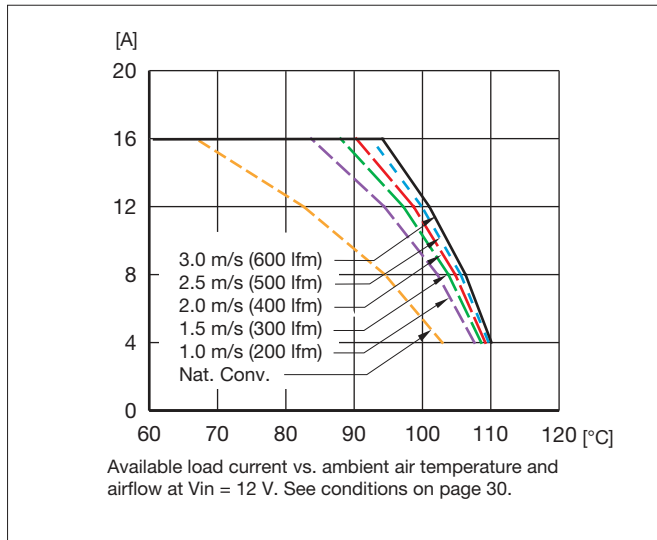

Output Characteristic

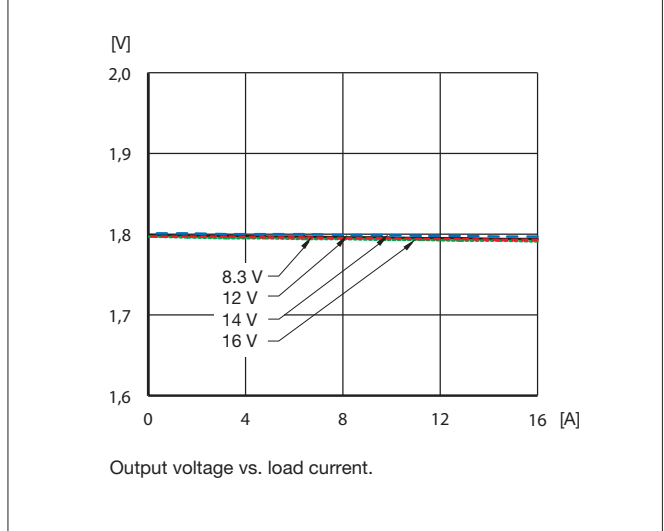

Start-Up

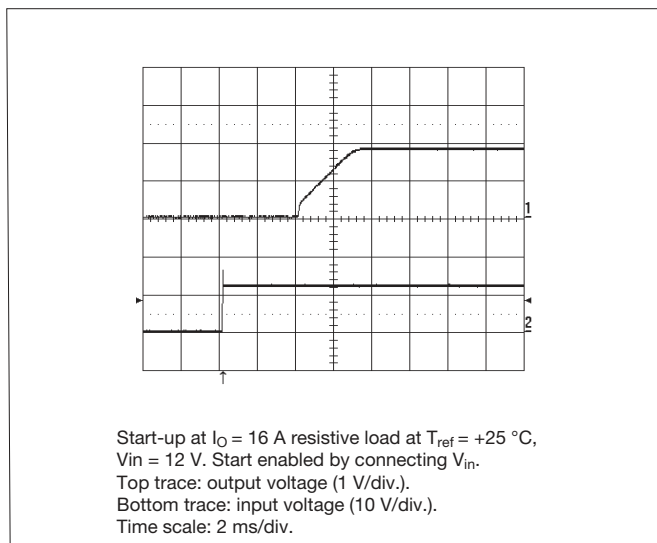

Turn Off

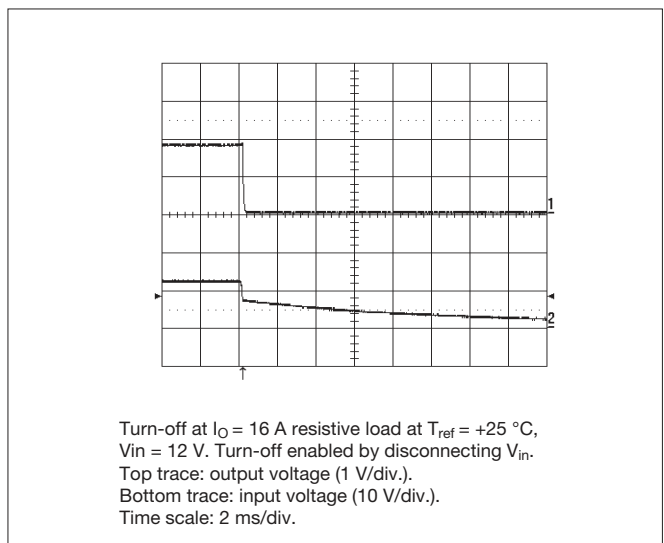

Adjusted to 1.8 Vout - Typical Characteristics

General conditions: Input filter 4 x 4.7 μ F, Output filter 2 x 150 μ F

Output Ripple

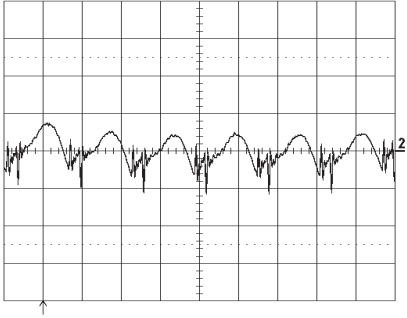

Output voltage ripple (20 mV/div.) at $T_{ref}=+25\text{ }^{\circ}\text{C}$,
 $V_{in} = 12\text{ V}$, $I_o = 16\text{ A}$ resistive load.
Band width = 5 MHz.
Time scale: 2 μ s/div.

Transient

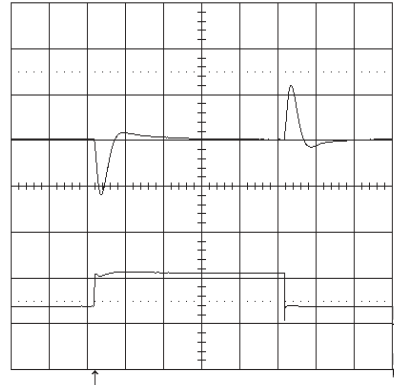

Output voltage response to load current step-change
(4-12-4 A) at $T_{ref}=+25\text{ }^{\circ}\text{C}$, $V_{in} = 12\text{ V}$. $dI/dt = 5\text{ A}/\mu\text{s}$
Top trace: output voltage (ac) (100 mV/div.).
Bottom trace: load current (dc) (10 A/div.)
Time scale: 0.1 ms/div.

Adjusted to 2.5 Vout - Data

$T_{ref} = -30 \dots +90 \text{ }^\circ\text{C}$, $V_I = 8.3 \dots 16 \text{ V}$ unless otherwise specified. Input filter $4 \times 4.7 \text{ } \mu\text{F}$, Output filter $2 \times 150 \text{ } \mu\text{F}$
 Typ values specified at: $T_{ref} = +25 \text{ }^\circ\text{C}$ and V_{Inom} . $I_{Omax} = 16 \text{ A}$. Note: +Sense connected to +Out. $R_{adj} 5\text{-}009 \text{ k}\Omega$

Characteristics		Conditions	Output			Unit
			min	typ	max	
dV_{Oi}	Output voltage adjusted setting	$T_{ref} = +25 \text{ }^\circ\text{C}$, V_{Inom} , I_{Omax}	-2		+2	% V_O
dV_O	Output voltage tolerance band	$I_O = 0.01 \dots 1.0 \times I_{Omax}$	-3		+3	% V_O
dV_O	Idling voltage	$I_O = 0 \text{ A}$	-2		+2	% V_O
dV_O	Line regulation	$V_{Imin} \dots V_{Imax}$, I_{Omax}		6		mV
dV_O	Load regulation	$I_O = 0.01 \dots 1.0 \times I_{Omax}$		25		mV
t_{tr}	Load transient recovery time	Load step = $0.25\text{-}0.75\text{-}0.25 \times I_{Omax}$, $di/dt = 5 \text{ A}/\mu\text{s}$, $C_O = 2 \times 150 \text{ } \mu\text{F}$, $V_I = 12 \text{ V}$		40		μs
V_{tr}	Load transient voltage	$V_I = 12 \text{ V}$		± 140		mV
T_{coeff}	Temperature coefficient	$T_{ref} = -30 \dots +90 \text{ }^\circ\text{C}$, I_{Omax}		-0.6		$\text{mV}/^\circ\text{C}$
t_s	Start-up V_I on to $0.9 \times V_O$	$I_O = I_{Omax}$, V_{Inom}		7		ms
t_r	Ramp-up, $V_I \dots 0.9 \times V_O$	$I_O = I_{Omax}$, V_{Inom}		3		ms
t_f	Fall time, V_I to $0.1 \times V_O$	$I_O = I_{Omax}$, V_{Inom}		1		ms
t_f	Fall time, V_I to $0.1 \times V_O$	$I_O = 0 \text{ A}$, V_{Inom}		16		s
t_{RC}	RC shut-down time $0.1 \times V_O$	$I_O = I_{Omax}$, V_{Inom}		1		ms
t_{RC}	RC start-up time $0.9 \times V_O$	$I_O = I_{Omax}$, V_{Inom}		7		ms
t_{RC}	RC fall time, $0.1 \times V_O$	$I_O = 0 \text{ A}$, V_{Inom}		16		s
I_O	Output current		0		16	A
P_{Omax}	Max output power		40			W
I_{lim}	Current limiting threshold	$T_{ref} < T_{refmax}$	19			A
V_{Oac}	Output ripple	20 Hz ... 5 MHz, I_{Omax}		50		mV_{p-p}
η	Efficiency - 50% load	$I_O = 0.5 \times I_{Omax}$, $V_O = 2.50 \text{ V}$		91.9		%
η	Efficiency - 100% load	$I_O = I_{Omax}$, $V_O = 2.50 \text{ V}$	88.8	91.3		%
P_d	Power Dissipation	$I_O = I_{Omax}$, $V_O = 2.50 \text{ V}$		3.8	5.0	W
F_o	Switching frequency	$I_O = (0 \dots 1) \times I_{Omax}$	260	300	340	kHz
I_{sense}	Remote sense current				10	mA
I_i	Static input current $V_I = 8.3 \text{ V}$	$I_O = I_{Omax}$, $V_O = 2.50 \text{ V}$		5.3		A
MTBF	Predicted reliability			5		million hours

Adjusted to 2.5 Vout - Typical Characteristics

General conditions: Input filter 4 x 4.7 μ F, Output filter 2 x 150 μ F

Efficiency

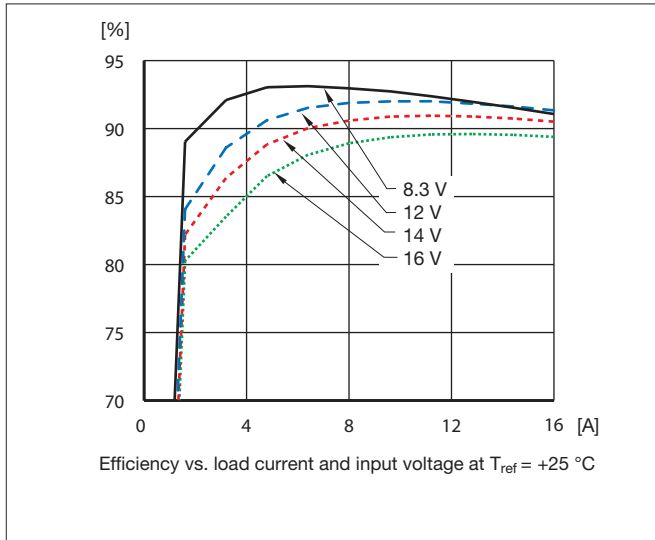

Power Dissipation

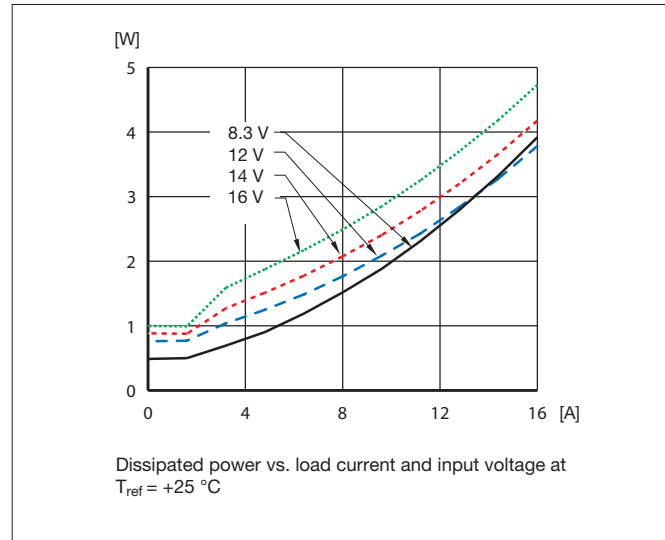

Output Current Derating at 12 V input

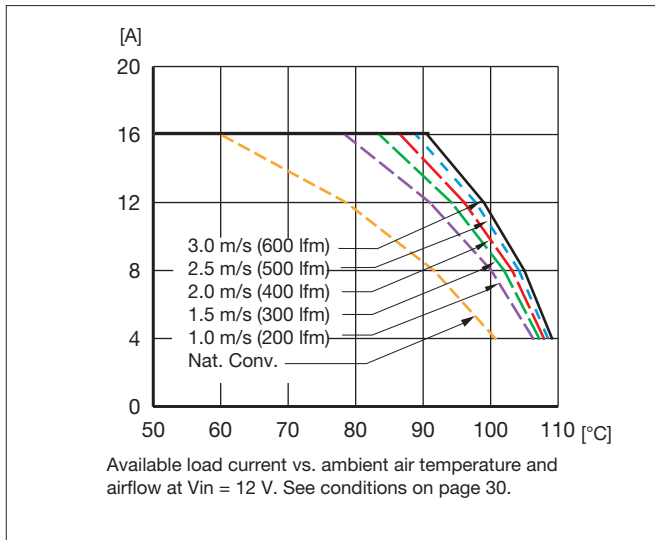

Output Characteristic

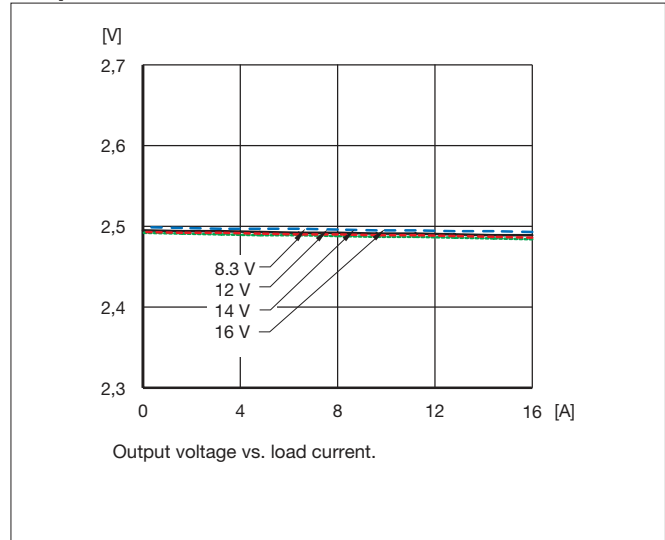

Start-Up

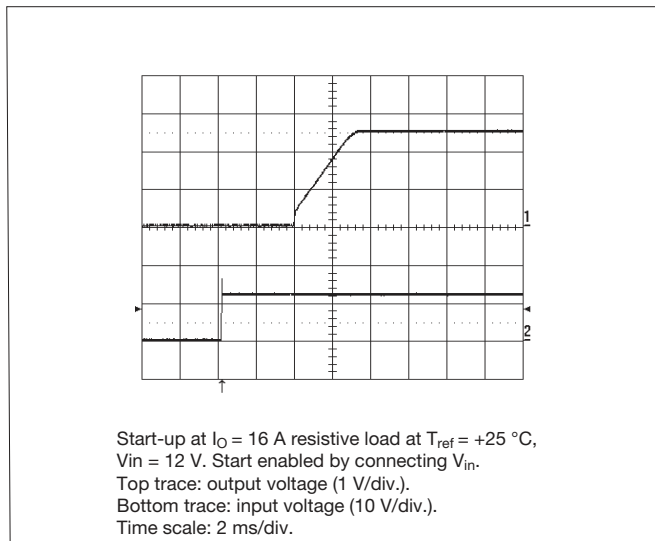

Turn Off

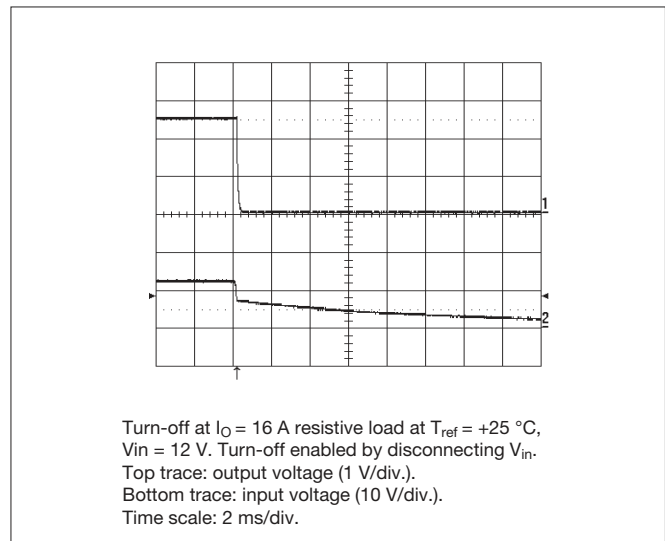

Adjusted to 2.5 Vout - Typical Characteristics

General conditions: Input filter 4 x 4.7 μ F, Output filter 2 x 150 μ F

Output Ripple

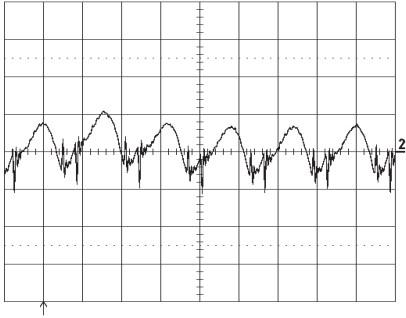

Output voltage ripple (20 mV/div.) at $T_{ref} = +25$ °C,
 $V_{in} = 12$ V, $I_O = 16$ A resistive load.
Band width = 5 MHz.
Time scale: 2 μ s/div.

Transient

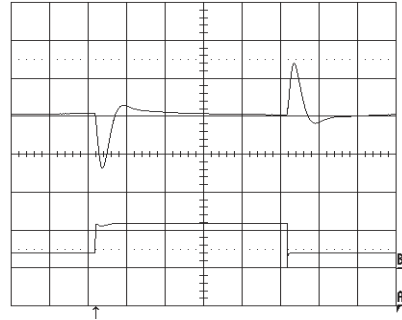

Output voltage response to load current step-change
(4-12-4 A) at $T_{ref} = +25$ °C, $V_{in} = 12$ V, $di/dt = 5$ A/ μ s
Top trace: output voltage (ac) (100 mV/div.).
Bottom trace: load current (dc) (10 A/div.)
Time scale: 0.1 ms/div.

Adjusted to 3.3 Vout - Data

$T_{ref} = -30 \dots +90 \text{ }^\circ\text{C}$, $V_I = 8.3 \dots 16 \text{ V}$ unless otherwise specified. Input filter $4 \times 4.7 \text{ } \mu\text{F}$, Output filter $2 \times 150 \text{ } \mu\text{F}$

Typ values specified at: $T_{ref} = +25 \text{ }^\circ\text{C}$ and V_{Inom} . $I_{Omax} = 16 \text{ A}$. Note: +Sense connected to +Out. $R_{adj} 3.122 \text{ k}\Omega$

Characteristics		Conditions	Output			Unit
			min	typ	max	
dV_{Oi}	Output voltage adjusted setting	$T_{ref} = +25 \text{ }^\circ\text{C}$, V_{Inom} , I_{Omax}	-2		+2	% V_O
dV_O	Output voltage tolerance band	$I_O = 0.01 \dots 1.0 \times I_{Omax}$	-3		+3	% V_O
dV_O	Idling voltage	$I_O = 0 \text{ A}$	-2		+2	% V_O
dV_O	Line regulation	$V_{Imin} \dots V_{Imax}$, I_{Omax}		6		mV
dV_O	Load regulation	$I_O = 0.01 \dots 1.0 \times I_{Omax}$		25		mV
t_{tr}	Load transient recovery time	Load step = $0.25-0.75-0.25 \times I_{Omax}$, $di/dt = 5 \text{ A}/\mu\text{s}$, $C_O = 2 \times 150 \text{ } \mu\text{F}$, $V_I = 12 \text{ V}$		40		μs
V_{tr}	Load transient voltage	$V_I = 12 \text{ V}$		± 140		mV
T_{coeff}	Temperature coefficient	$T_{ref} = -30 \dots +90 \text{ }^\circ\text{C}$, I_{Omax}		-0.6		mV/ $^\circ\text{C}$
t_s	Start-up V_I on to $0.9 \times V_O$	$I_O = I_{Omax}$, V_{Inom}		7		ms
t_r	Ramp-up, $V_I \dots 0.9 \times V_O$	$I_O = I_{Omax}$, V_{Inom}		3		ms
t_f	Fall time, V_I to $0.1 \times V_O$	$I_O = I_{Omax}$, V_{Inom}		1		ms
t_f	Fall time, V_I to $0.1 \times V_O$	$I_O = 0 \text{ A}$, V_{Inom}		17		s
t_{RC}	RC shut-down time $0.1 \times V_O$	$I_O = I_{Omax}$, V_{Inom}		1		ms
t_{RC}	RC start-up time $0.9 \times V_O$	$I_O = I_{Omax}$, V_{Inom}		7		ms
t_{RC}	RC fall time, $0.1 \times V_O$	$I_O = 0 \text{ A}$, V_{Inom}		17		s
I_O	Output current		0		16	A
P_{Omax}	Max output power		52.8			W
I_{lim}	Current limiting threshold	$T_{ref} < T_{refmax}$	19			A
V_{Oac}	Output ripple	20 Hz ... 5 MHz, I_{Omax}		50		mV _{p-p}
η	Efficiency - 50% load	$I_O = 0.5 \times I_{Omax}$, $V_O = 3.30 \text{ V}$		93.2		%
η	Efficiency - 100% load	$I_O = I_{Omax}$, $V_O = 3.30 \text{ V}$	90.6	92.9		%
P_d	Power Dissipation	$I_O = I_{Omax}$, $V_O = 3.30 \text{ V}$		4.0	5.5	W
F_o	Switching frequency	$I_O = (0 \dots 1) \times I_{Omax}$	260	300	340	kHz
I_{sense}	Remote sense current				10	mA
I_i	Static input current $V_I = 8.3 \text{ V}$	$I_O = I_{Omax}$, $V_O = 3.30 \text{ V}$		6.9		A
MTBF	Predicted reliability			5		million hours

Adjusted to 3.3 Vout - Typical Characteristics

General conditions: Input filter 4 x 4.7 μ F, Output filter 2 x 150 μ F

Efficiency

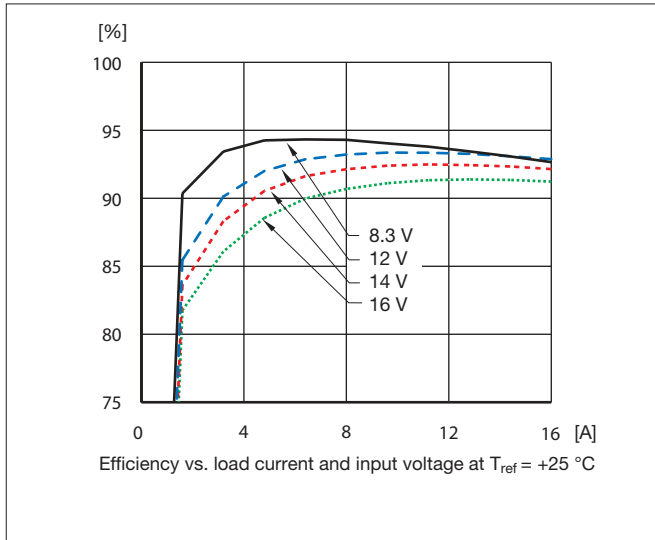

Power Dissipation

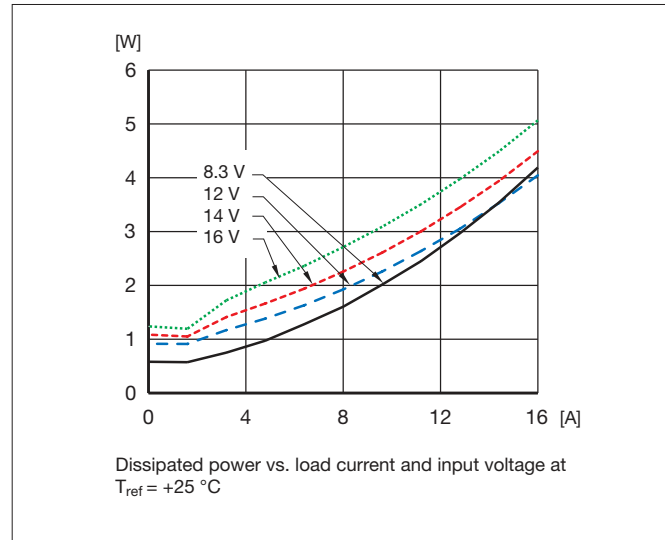

Output Current Derating at 12 V input

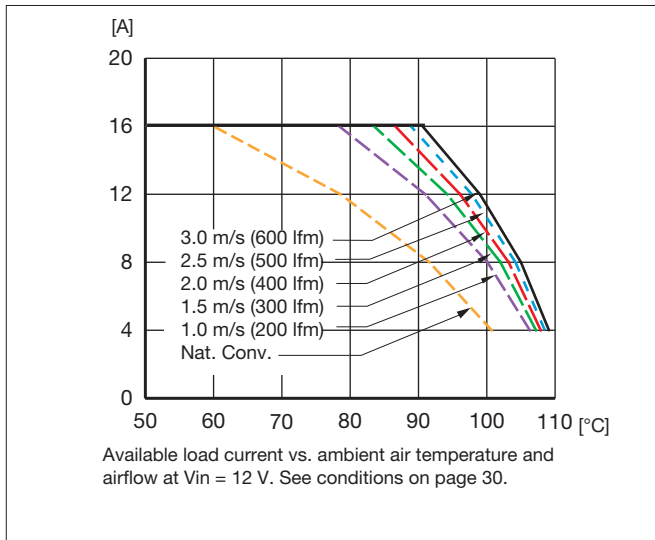

Output Characteristic

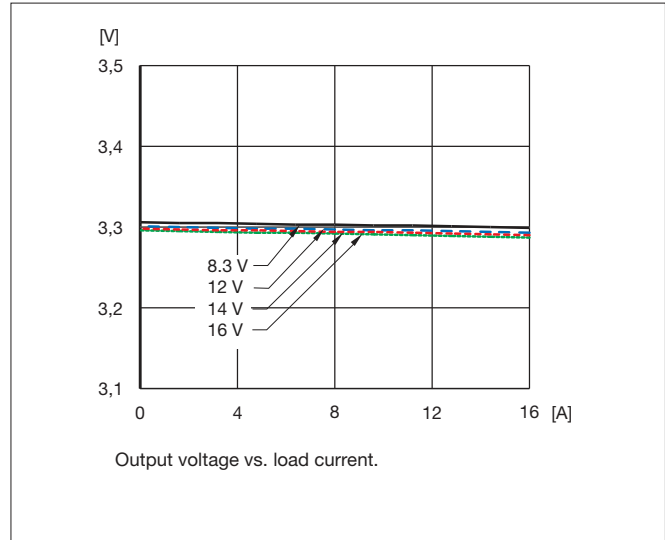

Start-Up

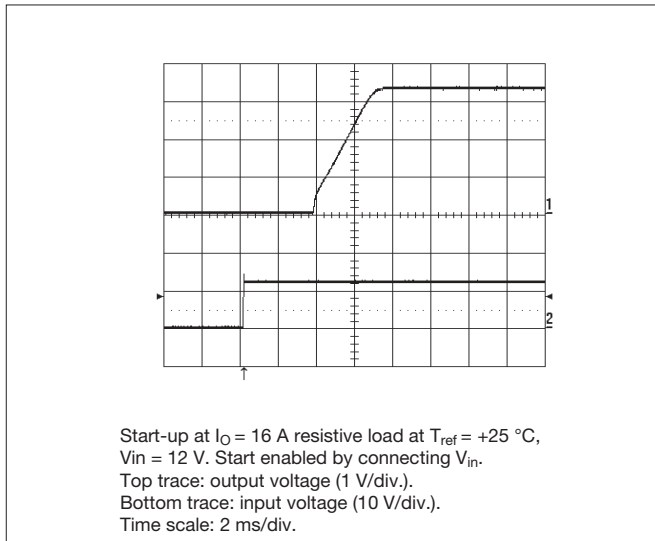

Turn Off

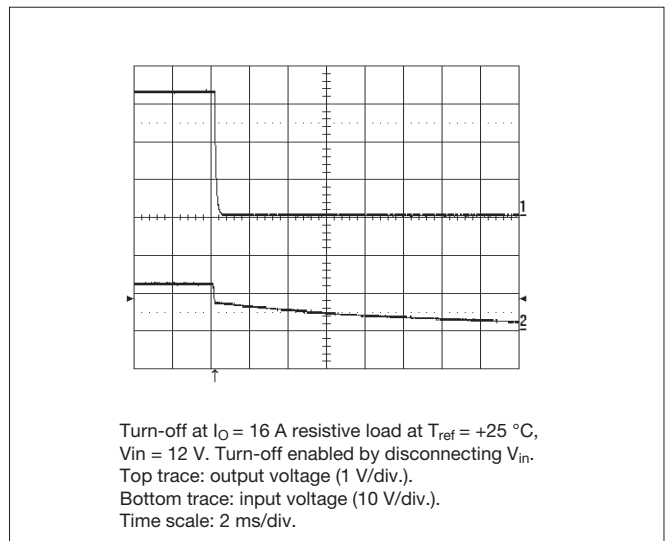

Adjusted to 3.3 Vout - Typical Characteristics

General conditions: Input filter 4 x 4.7 μ F, Output filter 2 x 150 μ F

Output Ripple

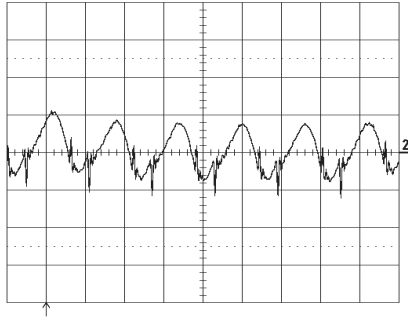

Output voltage ripple (20 mV/div.) at $T_{ref} = +25\text{ }^{\circ}\text{C}$,
 $V_{in} = 12\text{ V}$, $I_O = 16\text{ A}$ resistive load.
Band width = 5 MHz.
Time scale: 2 μ s/div.

Transient

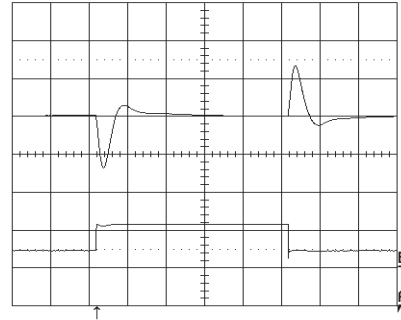

Output voltage response to load current step-change
(4-12-4 A) at $T_{ref} = +25\text{ }^{\circ}\text{C}$, $V_{in} = 12\text{ V}$. $dI/dt = 5\text{ A}/\mu\text{s}$
Top trace: output voltage (ac) (100 mV/div.).
Bottom trace: load current (dc) (10 A/div.)
Time scale: 0.1 ms/div.

Adjusted to 5.0 Vout - Data

$T_{ref} = -30 \dots +90 \text{ }^\circ\text{C}$, $V_I = 8.3 \dots 16 \text{ V}$ unless otherwise specified. Input filter $4 \times 4.7 \text{ } \mu\text{F}$, Output filter $2 \times 150 \text{ } \mu\text{F}$

Typ values specified at: $T_{ref} = +25 \text{ }^\circ\text{C}$ and V_{Inom} . $I_{Omax} = 16 \text{ A}$. Note: +Sense connected to +Out. $R_{adj} 1.472 \text{ k}\Omega$

Characteristics		Conditions	Output			Unit
			min	typ	max	
dV_{Oi}	Output voltage adjusted setting	$T_{ref} = +25 \text{ }^\circ\text{C}$, V_{Inom} , I_{Omax}	-2		+2	% V_O
dV_O	Output voltage tolerance band	$I_O = 0.01 \dots 1.0 \times I_{Omax}$	-3		+3	% V_O
dV_O	Idling voltage	$I_O = 0 \text{ A}$	-2		+2	% V_O
dV_O	Line regulation	$V_{Imin} \dots V_{Imax}$, I_{Omax}		12		mV
dV_O	Load regulation	$I_O = 0.01 \dots 1.0 \times I_{Omax}$		25		mV
t_{tr}	Load transient recovery time	Load step = $0.25\text{-}0.75\text{-}0.25 \times I_{Omax}$, $dI/dt = 5 \text{ A}/\mu\text{s}$, $C_O = 2 \times 150 \text{ } \mu\text{F}$, $V_I = 12 \text{ V}$		40		μs
V_{Tr}	Load transient voltage			-150 +190		mV
T_{coeff}	Temperature coefficient	$T_{ref} = -30 \dots +90 \text{ }^\circ\text{C}$, I_{Omax}		-0.6		$\text{mV}/^\circ\text{C}$
t_s	Start-up V_I on to $0.9 \times V_O$	$I_O = I_{Omax}$, V_{Inom}		7		ms
t_r	Ramp-up, $V_I \dots 0.9 \times V_O$	$I_O = I_{Omax}$, V_{Inom}		3		ms
t_f	Fall time, V_I to $0.1 \times V_O$	$I_O = I_{Omax}$, V_{Inom}		1		ms
t_f	Fall time, V_I to $0.1 \times V_O$	$I_O = 0 \text{ A}$, V_{Inom}		16		s
t_{RC}	RC shut-down time $0.1 \times V_O$	$I_O = I_{Omax}$, V_{Inom}		1		ms
t_{RC}	RC start-up time $0.9 \times V_O$	$I_O = I_{Omax}$, V_{Inom}		7		ms
t_{RC}	RC fall time, $0.1 \times V_O$	$I_O = 0 \text{ A}$, V_{Inom}		15		s
I_O	Output current		0		16	A
P_{Omax}	Max output power		80			W
I_{lim}	Current limiting threshold	$T_{ref} < T_{refmax}$	19			A
V_{Oac}	Output ripple	20 Hz ... 5 MHz, I_{Omax}		50		mV_{p-p}
η	Efficiency - 50% load	$I_O = 0.5 \times I_{Omax}$, $V_O = 3.30 \text{ V}$		94.9		%
η	Efficiency - 100% load	$I_O = I_{Omax}$, $V_O = 3.30 \text{ V}$	91.3	94.7		%
P_d	Power Dissipation	$I_O = I_{Omax}$, $V_O = 3.30 \text{ V}$		4.5	7.6	W
F_o	Switching frequency	$I_O = (0 \dots 1) \times I_{Omax}$	260	300	340	kHz
I_{sense}	Remote sense current				10	mA
I_I	Static input current $V_I = 8.3 \text{ V}$	$I_O = I_{Omax}$, $V_O = 3.30 \text{ V}$		10.2		A
MTBF	Predicted reliability			5		million hours

Adjusted to 5.0 V out - Typical Characteristics

General conditions: Input filter 4 x 4.7 μ F, Output filter 2 x 150 μ F

Efficiency

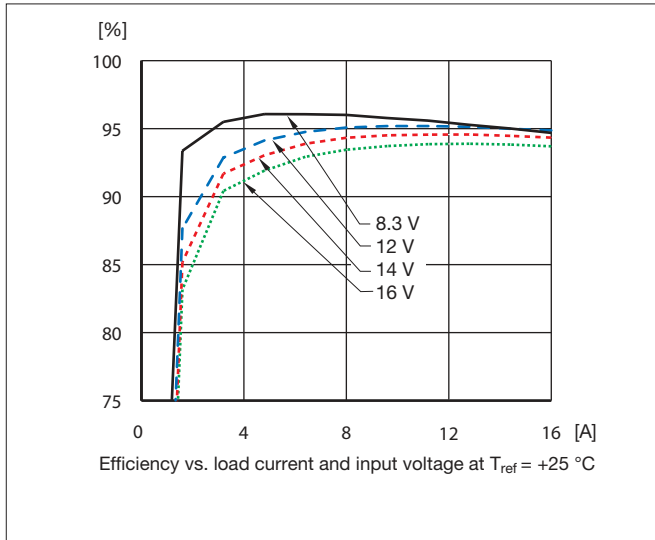

Power Dissipation

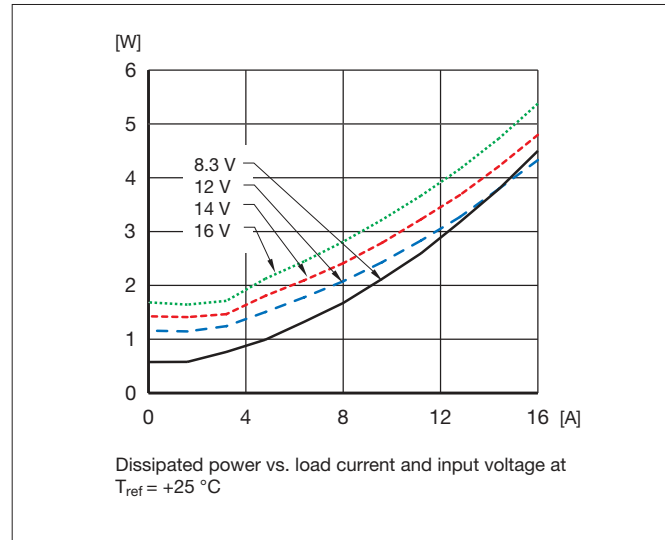

Output Current Derating at 12 V input

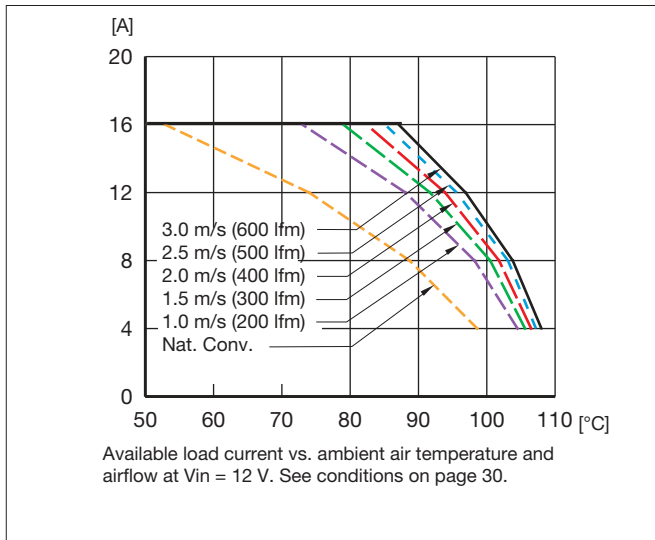

Output Characteristic

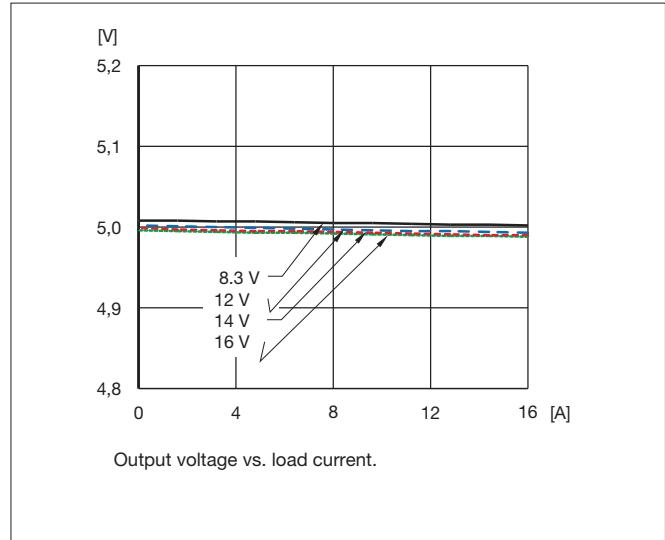

Start-Up

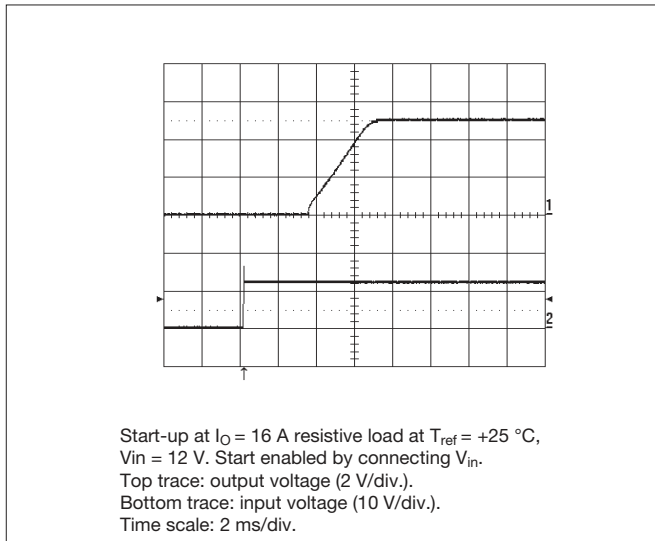

Turn Off

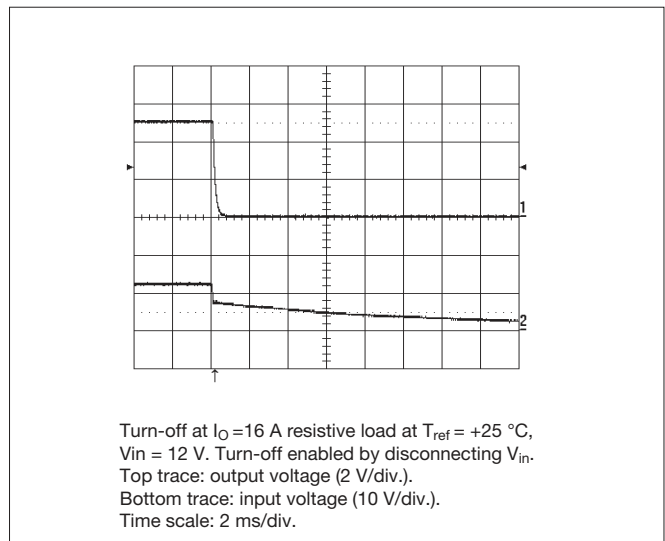

Adjusted to 5.0 V out - Typical Characteristics

General conditions: Input filter 4 x 4.7 μ F, Output filter 2 x 150 μ F

Output Ripple

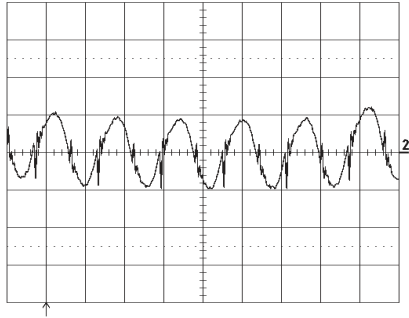

Output voltage ripple (20 mV/div.) at $T_{ref} = +25\text{ }^{\circ}\text{C}$,
 $V_{in} = 12\text{ V}$, $I_O = 16\text{ A}$ resistive load.
Band width = 5 MHz.
Time scale: 2 μ s/div.

Transient

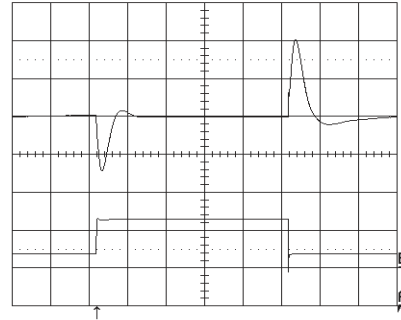

Output voltage response to load current step-change
(4-12-4 A) at $T_{ref} = +25\text{ }^{\circ}\text{C}$, $V_{in} = 12\text{ V}$. $dI/dt = 5\text{ A}/\mu\text{s}$
Top trace: output voltage (ac) (100 mV/div.).
Bottom trace: load current (dc) (10 A/div.)
Time scale: 0.1 ms/div.

EMC Specification

The conducted EMI measurement was performed using a regulator placed directly on the test bench. The fundamental switching frequency for PMC 8000 is 300 kHz. The measurement below has been performed with $V_{in} = 12\text{ V}$, $V_{out} = 5\text{ V}$ and max load. Input filter $4 \times 4.7\text{ }\mu\text{F}$ and output filter $2 \times 150\text{ }\mu\text{F}$ was used during the measurement.

Conducted EMI Input terminal value (typ)

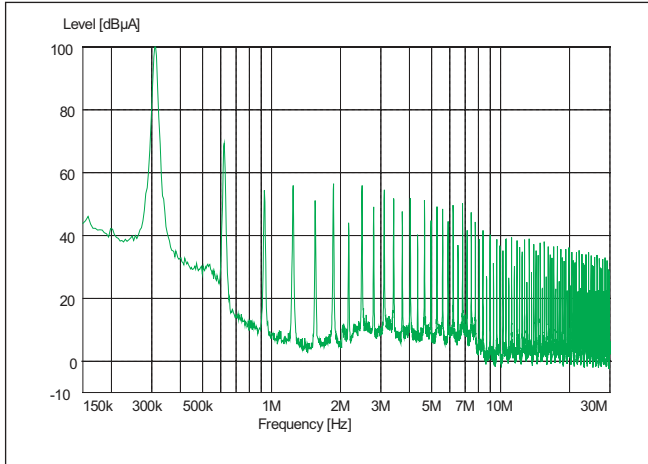

PMC 8818.

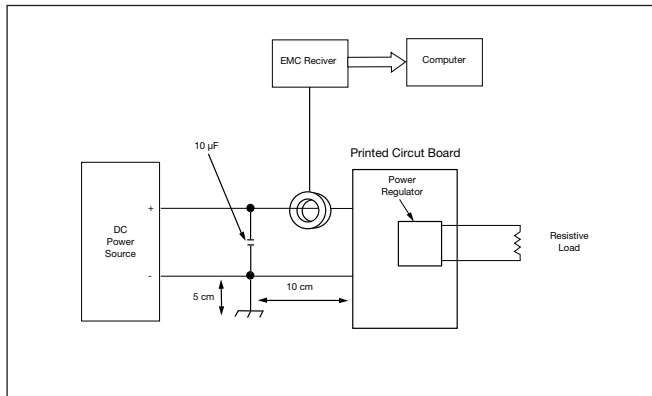

Layout Recommendation

The radiated EMI performance of the DC/DC regulator will be optimised by including a ground plane in the PCB area under the DC/DC regulator. This approach will return switching noise to ground as directly as possible, with improvements to both emissions and susceptibility.

Output ripple and noise

The circuit below has been used for the ripple and noise measurements on the PMC 8000 Series DC/DC regulators.

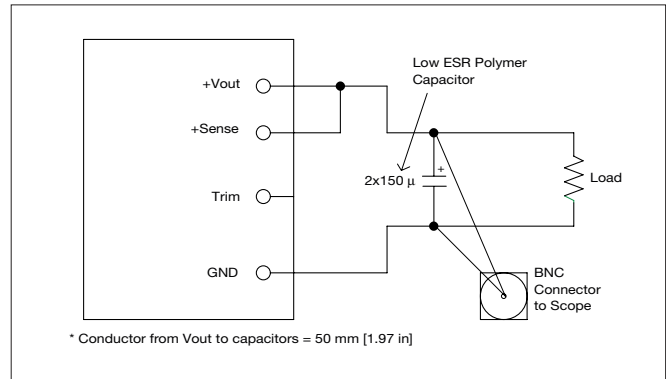

Output ripple and noise test setup

Operating Information

Output Voltage Adjust (V_{adj})

All PMC 8000 Series DC/DC regulators have an Output Voltage adjust pin (V_{adj}). This pin can be used to adjust the output voltage above output voltage initial setting (0.75 V). When increasing the output voltage the maximum power rating of the converter remains the same, and the output current capability will therefore decrease correspondingly. To increase the output voltage a resistor or a voltage signal should be connected/applied between V_{adj} pin and GND. The resistor/voltage signal value for some standard output trims are given below, for other voltage set points use the formulas to calculate the correct resistor or voltage signal. For output voltages of 5.25 V and higher the input voltage is restricted to maximum 14 Vin.

Formula 1: $R_{adj} = (10\,500 / (V_{out} - 0.7525)) - 1000$ (ohm)

Formula 2: $V_{trim} = (0.7 - 0.0667 \times (V_{out} - 0.7525))$ (V)

Vout (V)	Radj (kohm)	Vtrim (V)
0.75	Open	Open
1.0	41.42	0.684
1.2	22.46	0.670
1.5	13.05	0.650
1.8	9.024	0.630
2.5	5.009	0.583
3.3	3.122	0.530
5.00	1.472	0.417
5.50	1.212	0.383

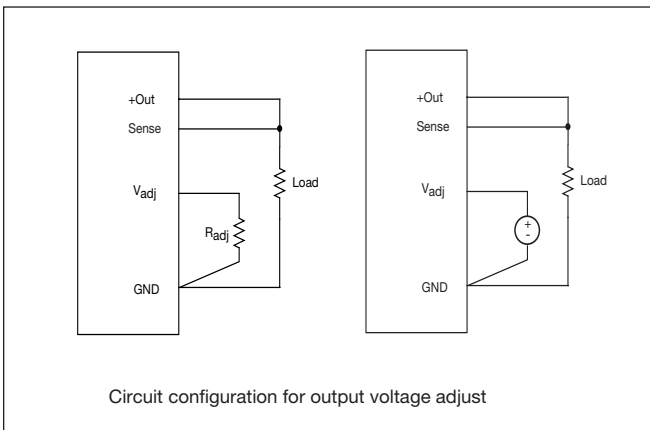

Input Voltage

The input voltage range 8.3...16 Vdc makes the PMC 8000 easy to use in intermediate bus applications when powered by a non-regulated bus converter or a regulated bus converter. For output voltage trims over 5.25 Vout the input voltage must be reduced to a maximum of 14 V in order to maintain specified data.

Turn off input voltage

The PMC 8000 Series DC/DC regulators monitor the input voltage and will turn on and turn off at predetermined levels. The minimum hysteresis between turn on and turn off input voltage is 0.2 V where the turn on input voltage is the highest.

Remote Control (RC)

Standard Version with "positive logic".

The RC pin may be used to turn on or turn off the regulator using a suitable open collector function.

Turn off is achieved by connecting the RC pin to ground.

The regulator will run in normal operation when the RC pin is left open.

RC	Regulator condition	min	typ	max	Unit
Low level referenced to GND	OFF	-0.3		0.3	V
Open	ON	1.7		16	V

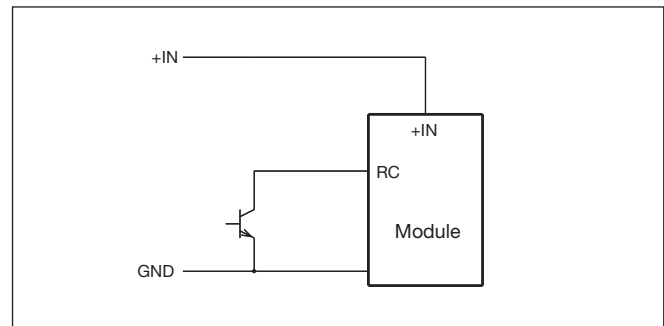

Option "negative logic"

The RC pin may be used to turn on or turn off the regulator using a suitable open collector function.

Turn off is achieved by connecting the RC pin to the input voltage. The regulator will run in normal operation when the RC pin is left open.

RC	Regulator condition	min	typ	max	Unit
High level referenced to GND	OFF	1.7		16	V
Open	ON				

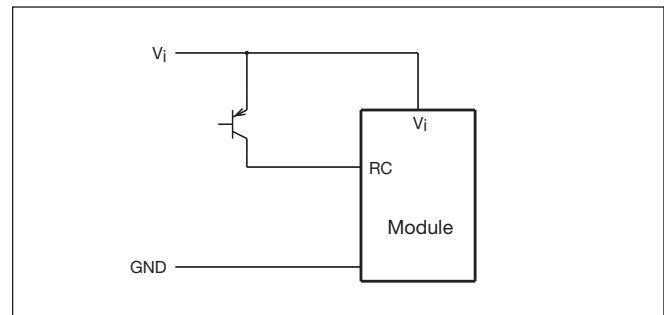

Operating Information

Remote Sense

All PMC 8000 Series DC/DC regulators have a positive remote sense pin that can be used to compensate for moderate amounts of resistance in the distribution system and allow for voltage regulation at the load or other selected point. The remote sense line will carry very little current and does not need a large cross sectional area. However, the sense line on the PCB should be located close to a ground trace or ground plane. The remote sense circuitry will compensate for up to 10% voltage drop between the sense voltage and the voltage at the output pins from V_{ONom} . If the remote sense is not needed the sense pin should be left open or connected to the positive output.

Current Limit Protection

The PMC 8000 Series DC/DC regulators include current limiting circuitry that allows them to withstand continuous overloads or short circuit conditions on the output. The output voltage will decrease towards zero for output currents in excess of max output current (I_{Omax}). When the current limit is reached the regulator will go into hiccup mode.

The current limit is temperature dependent, i.e. the limit decrease at higher operating temperature, the regulator is guaranteed to start at $I_{Omax} \times 1.25$ @ $T_{ref} 115^{\circ}C$.

The regulator will resume normal operation after removal of the overload. The load distribution system should be designed to carry the maximum output short circuit current specified.

Over Temperature Protection (OTP)

The PMC 8000 Series DC/DC regulators are protected from thermal overload by an internal over temperature shutdown circuit. When the PCB temperature near the IC circuit reaches $130^{\circ}C$ the converter will shut down immediately. The regulator will make continuous attempts to start up (non-latching mode) and resume normal operation automatically when the temperature has dropped below the temperature threshold.

Input And Output Impedance

The impedance of both the power source and the load will interact with the impedance of the DC/DC regulator. It is most important to have a low characteristic impedance, both at the input and output, as the regulators have a low energy storage capability. Use capacitors across the input if the source inductance is greater than $4.7 \mu H$. Suitable input capacitors are $22 \mu F - 220 \mu F$ low ESR ceramics.

Minimum Required External Capacitors

Required Input Filter

External input capacitors are required to increase the lifetime of the internal capacitors. Low ESR ceramics should be used, the minimum input capacitance is stated below.

PMC 8818T S $2 \times 4.7 \mu F$.

Optional Input Filter

To minimize input ripple and to ensure even better stability more capacitors can be added, see table below.

Consider the max output power in a given application and choose sufficient capacitors to obtain desired ripple level. Make sure that the extra capacitors are placed near the input pins.

The table below is just an example since the board layout also has effect on the result.

Output power	Desired input ripple (mV _{p-p})		
	150	250	500
0-20 W	2 x 4.7 μF	-----	-----
20-40 W	5 x 4.7 μF	2 x 4.7 μF	-----
40-60 W	8 x 4.7 μF	4 x 4.7 μF	2 x 4.7 μF
60-80 W	11 x 4.7 μF	7 x 4.7 μF	4 x 4.7 μF

Note: All output characteristics in the datasheet are measured with $4 \times 4.7 \mu F$ at the input pins.

Required output filter

External output capacitance is also required to reduce the output ripple and to obtain specified load step response. It is recommended to use low ESR polymer capacitors or low ESR ceramic capacitors.

Minimum requirement:

PMC 8818T S $2 \times 150 \mu F$. (*low ESR polymer type*).

This is the output filter used in the verification and a requirement to meet the specification.

Maximum Capacitive Load

When powering loads with significant dynamic current requirements, the voltage regulation at the load can be improved by addition of decoupling capacitance at the load. The most effective technique is to locate low ESR ceramic capacitors as close to the load as possible, using several capacitors to lower the total ESR. These ceramic capacitors will handle short duration high-frequency components of dynamic load changes. In addition, higher values of capacitors (electrolytic capacitors) should be used to handle the mid-frequency components. It is equally important to use good design practice when configuring the DC distribution system.

Low resistance and low inductance PCB layouts and cabling should be used. Remember that when using remote sensing, all resistance (including the ESR), inductance and capacitance of the distribution system is within the feedback loop of the regulator. This can affect on the regulators compensation and the resulting stability and dynamic response performance.

Very low ESR and high capacitance must be used with care.

A “rule of thumb” is that the total capacitance must never exceed typically $500-700 \mu F$ if only low ESR ($< 2 m\Omega$) ceramic capacitors is used. If more capacitance is needed, a combination of low ESR type and electrolytic capacitors should be used, otherwise the stability will be affected.

The PMC 8000 series regulator can accept up to 8 mF of capacitive load on the output at full load. This gives <math><500 \mu\text{F}/\text{A}</math> of I_O . When using that large capacitance it is important to consider the selection of output capacitors; the resulting behavior is a combination of the amount of capacitance and ESR.

A combination of low ESR and output capacitance exceeding 8 mF for PMC 8818 can cause the regulator into over current protection mode (hick-up) due to high start up current. The output filter must therefore be designed without exceeding the above stated capacitance levels if the ESR is lower then 30-40 m Ω .

Parallel Operation

The PMC 8000 Series DC/DC regulators can be connected in parallel with a common input. Paralleling is accomplished by connecting the output voltage pins directly and using a load sharing device on the input. Layout considerations should be made to avoid load imbalance. For more details on paralleling, please consult your local applications support.

Thermal Considerations

General

The PMC 8000 Series DC/DC regulators are designed to operate in a variety of thermal environments, however sufficient cooling should be provided to help ensure reliable operation. Heat is removed by conduction, convection and radiation to the surrounding environment. Increased airflow enhances the heat transfer via convection.

Proper cooling can be verified by measuring the temperature at the reference point (T_{ref}).

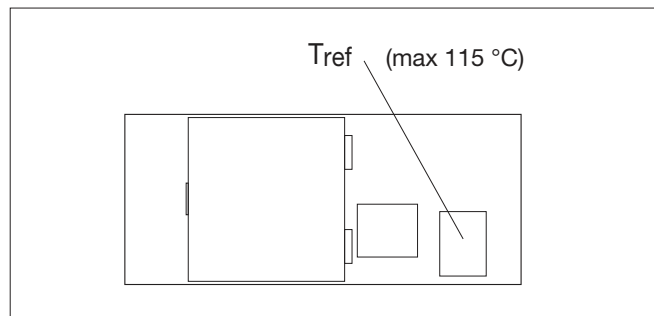

The PMC 8000 thermal testing is performed with the product mounted on an FR4 board 254 × 254 mm with 8 layers of 35 μm copper.

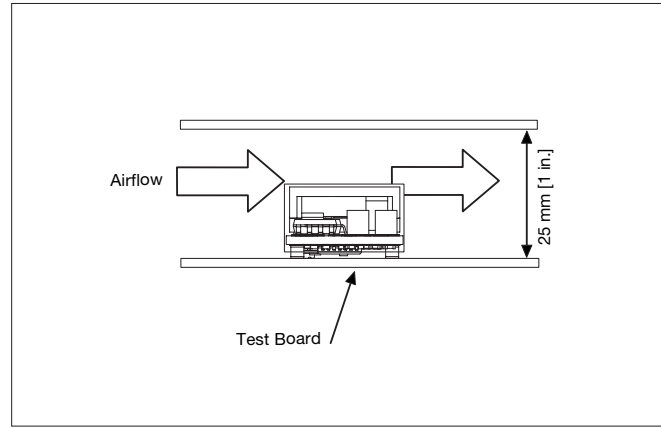

Calculation of ambient temperature

By using the thermal resistance the maximum allowed ambient temperature can be calculated.

1. The powerloss is calculated by using the formula $((1/\eta) - 1) \times \text{output power} = \text{power losses}$.
 η = efficiency of converter. E.g 88% = 0.88
2. Find the value of the thermal resistance for each product in the diagram by using the airflow speed at the output section of the converter. Take the thermal resistance x powerloss to get the temperature increase.
3. Max allowed calculated ambient temperature is: Max T_{ref} of DC/DC regulator – temperature increase.

E.g 5 V output at 1 m/s, full load, 12 V in:

A. $((\frac{1}{0.94}) - 1) \times 80 \text{ W} = 5.11 \text{ W}$

B. $5.11 \text{ W} \times 8 \text{ }^\circ\text{C}/\text{W} = 40.9 \text{ }^\circ\text{C}$

C. $115 \text{ }^\circ\text{C} - 40.9 \text{ }^\circ\text{C} = \text{max ambient temperature is } 74.1 \text{ }^\circ\text{C}$

The real temperature will be dependent on several factors, like PCB size and type, direction of airflow, air turbulence etc. It is recommended to verify the temperature by testing.

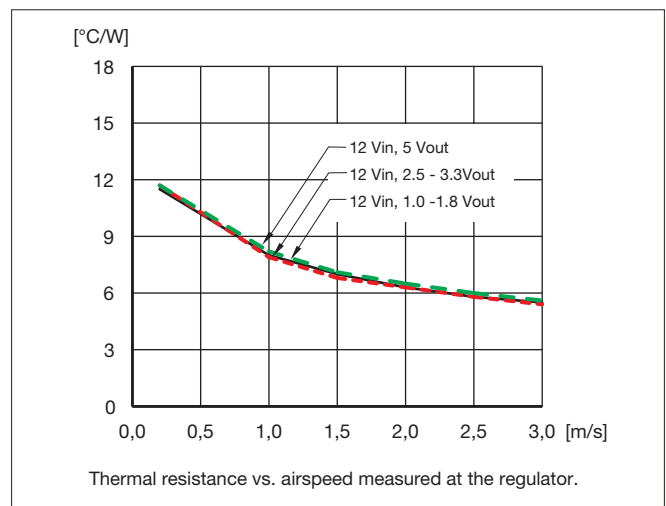

Soldering Information

The PMC series DC/DC regulators are intended for reflow soldering processes. Extra precautions must be taken when reflow soldering the module. Neglecting the soldering information given below may result in permanent damage or significant degradation of the power module performance. No responsibility is assumed if these recommendations are not strictly followed.

The module can be reflow soldered using vapour phase reflow (VPR) or forced convection reflow.

To ensure proper soldering of the regulators the temperature should be monitored on interconnection pin GND. The interconnection GND is considered as representative due to the heavy copper path characterisation.

A thermocouple can be attached to the pin GND by means of a suitable adhesive or heat conductive paste, see the mechanical data on page 4.

The reflow profile should be optimised to avoid solder paste drying and overheating of the module. Most important is to ensure that the interconnection pins on the coldest area reach sufficient soldering temperature for sufficiently long time. A sufficiently extended soak time is recommended to ensure an even temperature throughout the PCB, for both small and large components. To reduce the risk of overheating the power module, it is also recommended to minimise the time in reflow as much as possible.

High temperature solders - Reflow profile

Ramp up, ramp-down rate			
Pre-heat	Soak zone	Reflow zone	Cooling
max 3°C/s	max 0.5°C/s	max 3°C/s	max 4°C/s
Temperature interval, time			
	Soak zone	Reflow zone	
	150-200°C, 60-180 s	Above 220°C, 30-80 s	
Peak temperature, time			
		Reflow zone	
		235-245°C, 10-30 s	

For lead free solder processes (solder melting point 217°C), the PMC series is qualified for MSL 1 according to JEDEC standard “J-STD-020c”. During reflow, the module temperature must not exceed +245 °C at any time.

Low temperature solder - reflow profile

Ramp up, ramp-down rate			
Pre-heat	Soak zone	Reflow zone	Cooling
max 3°C/s	max 0.5°C/s	max 3°C/s	max 4°C/s
Temperature interval, time			
	Soak zone	Reflow zone	
	130-170°C, 60-120 s	Above 183°C, 30-80 s	
Peak temperature, time			
		Reflow zone	
		210-225°C, 10-30 s	

For conventional Sn-Pb solder processes (solder melting point 179°C -183°C), The PMC series is qualified for MSL 1 according to JEDEC standard “J-STD-020c”. During reflow, the module temperature must not exceed +225 °C at any time.

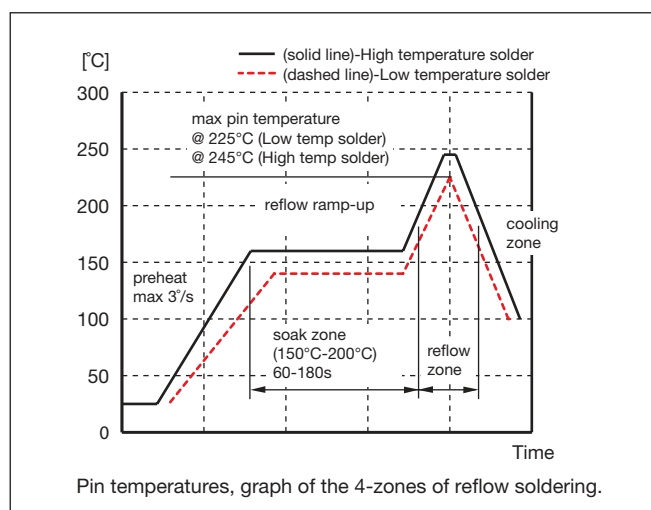

Delivery Package Information

The PMC 8000 series regulators are delivered in antistatic tape & reel (EIA standards 481-2).

Tape & reel specification:

Material:	Conductive
Tape width:	44 mm [1.73 in.]
Tape pitch:	24 mm [0.95 in.]
Total pocket height:	9.1 mm [0.36 in.]
Reel diameter:	330 mm [13 in.]
Reel capacity:	200 pieces
Full reel weight:	typ. 2.0 kg

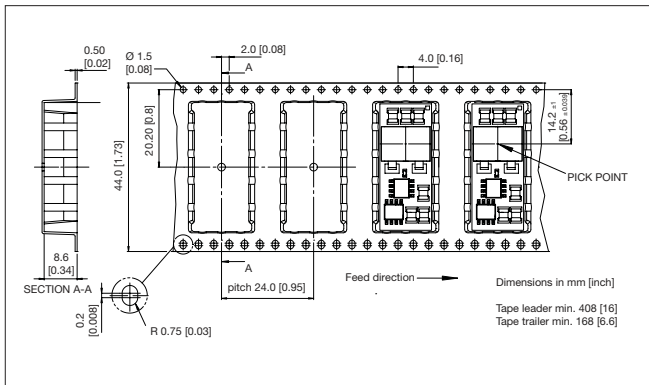

Design for environment (DfE)

The PMC 8000 series DC/DC regulators comply with the RoHS directive.

Reliability

The Mean Time Between Failure (MTBF) of the PMC 8000 series DC/DC regulator family is calculated to be greater than 5 million hours at full output power and a reference temperature of +40 °C using TelCordia SR 332.