

*High Efficiency 1x/1.5x Charge Pump*

**General Description**

The AAT3351 is a low-noise, constant-frequency charge pump DC/DC converter that uses a dual-mode load switch (1x) and fractional (1.5x) charge pump to maximize efficiency for white LED applications. The AAT3351 is capable of driving 4 white LEDs at a total of 120mA from single 2.7V to 5.5V input. The current sinks may be operated individually or in parallel while driving higher-current LEDs. A low external parts count (two 1μF flying capacitors and two small 1μF capacitors at V<sub>IN</sub> and V<sub>OUT</sub>) makes the AAT3351 ideal for small battery-powered applications.

Skyworks' S<sup>2</sup>Cwire™ serial digital input is used to enable, disable, and set current to one of 32 levels for the LEDs.

The AAT3351 is equipped with built-in short-circuit protection. The soft-start circuitry prevents excessive inrush current at start-up and mode transitions. The AAT3351 family is available in Pb-free, space-saving TSOPJW and TDFN33 packages, and operates over the -40°C to +85°C ambient temperature range.

**Features**

- Drives up to 4 LEDs at up to 30mA, each
- Automatic Switching Between 1x and 1.5x Modes
- 1MHz Switching Frequency
- Linear LED Output Current Control
  - Single-wire, S<sup>2</sup>Cwire Interface
  - 32-step
- ±10% LED Output Current Accuracy
- 3% LED Output Current Matching
- Low-Current Shutdown Mode
- Automatic Soft-Start
- TSOPJW-14 and TDFN33-12 Packages

**Applications**

- Cellular and Smart Phones
- Digital Still and Video Cameras
- PDAs
- Portable Devices
- Portable Media Players
- Other White LED Backlighting

**Typical Application**

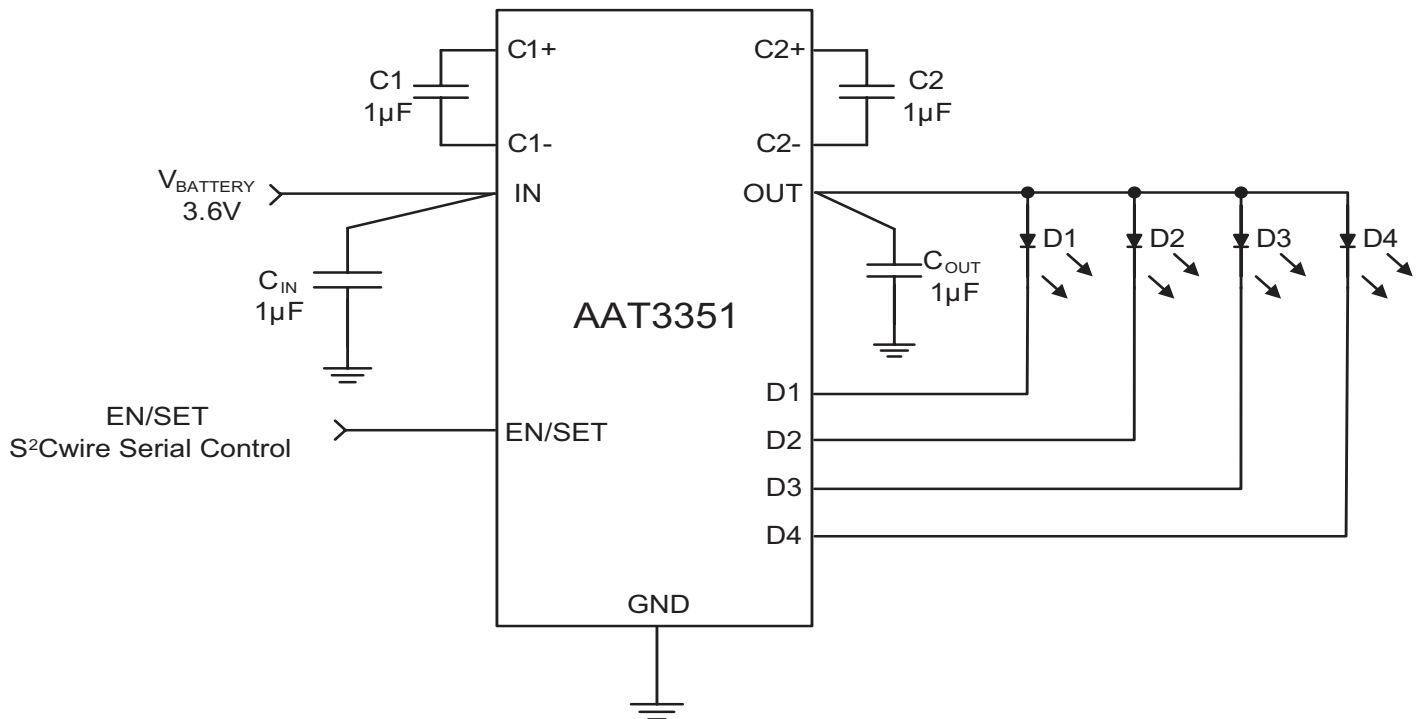

# AAT3351

## High Efficiency 1x/1.5x Charge Pump

### Pin Descriptions

Pin Number		Name	Function
TDFN33-12	TSOPJW-14		
1	2	D4	Backlight LED 4 current sink. D4 controls the current through backlight LED 4. Connect the cathode of backlight LED 4 to D4. If not used, connect D4 to OUT.
2	12	EN/SET	S <sup>2</sup> Cwire serial interface control pin.
3	11	C2-	Negative terminal of charge pump capacitor 2.
4	10	C2+	Positive terminal of charge pump capacitor 2. Connect the 1μF charge pump capacitor 2 from C2+ to C2-.
5	9	OUT	Charge pump output. OUT is the output of the charge pump and supplies current to the backlight LEDs. Connect the backlight LED anodes to OUT. Bypass OUT to PGND with a 1μF or larger ceramic capacitor as close to the AAT3351 as possible.
6	8	C1-	Negative terminal of charge pump capacitor 1.
7	7	C1+	Positive terminal of charge pump capacitor 1. Connect the 1μF charge pump capacitor 1 from C1+ to C1-.
8	6	IN	Power input. Connect IN to the input source voltage. Bypass IN to GND with a 1μF or larger ceramic capacitor as close to the AAT3351 as possible.
9	5	GND	Ground pin.
10	4	D1	Backlight LED 1 current sink. D1 controls the current through backlight LED 1. Connect the cathode of backlight LED 1 to D1. If not used, connect D1 to OUT.
11	3	D2	Backlight LED 2 current sink. D2 controls the current through backlight LED 2. Connect the cathode of backlight LED 2 to D2. If not used, connect D2 to OUT.
12	1	D3	Backlight LED 3 current sink. D3 controls the current through backlight LED 3. Connect the cathode of backlight LED 3 to D3. If not used, connect D3 to OUT.
N/A	13, 14	N/C	Not connected.
EP	N/A	EP	Exposed paddle (bottom). Connect to GND directly beneath package.

### Pin Configuration

**TSOPJW-14  
(Top View)**

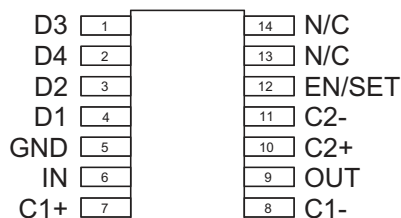

**TDFN33-12  
(Top View)**

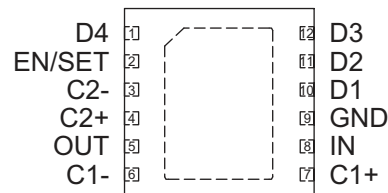

*High Efficiency 1x/1.5x Charge Pump***Absolute Maximum Ratings**

$T_A = 25^\circ\text{C}$  unless otherwise noted.

Symbol	Description	Value	Units
$V_{IN}$	Input Voltage	-0.3 to 6	V
$V_{OUT}$	Charge Pump Output	-0.3 to 6	V
$V_{EN/SET}$	EN/SET to GND Voltage	-0.3 to 6	V
$V_{EN/SET(MAX)}$	Maximum $V_{EN/SET}$ to $V_{IN}$ Voltage ( $V_{EN/SET} - V_{IN}$ )	+0.3	V
$I_{OUT}$	Maximum DC Output Current	150	mA
$T_J$	Operating Junction Temperature Range	-40 to 150	$^\circ\text{C}$

**Thermal Information<sup>1</sup>**

Symbol	Description	Value	Units
$P_D$	Maximum Power Dissipation <sup>1</sup>	TDFN33-12 <sup>2</sup>	2000
		TSOPJW-14 <sup>3</sup>	625
$\theta_{JA}$	Maximum Thermal Resistance	TDFN33-12	50
		TSOPJW-14	160

1. Mounted on 1.6mm thick FR4 circuit board.
2. Derate 25mW/ $^\circ\text{C}$  above 25 $^\circ\text{C}$  ambient temperature.
3. Derate 6.25mW/ $^\circ\text{C}$  above 25 $^\circ\text{C}$  ambient temperature.

**High Efficiency 1x/1.5x Charge Pump**

## Electrical Characteristics

$V_{IN} = 3.6V$ ;  $C_{IN} = C_{OUT} = 1\mu F$ ;  $C_1 = C_2 = 1\mu F$ ;  $T_A = -40^{\circ}C$  to  $85^{\circ}C$  unless otherwise noted. Typical values are  $T_A = 25^{\circ}C$ .

Symbol	Description	Conditions	Min	Typ	Max	Units
<b>Input Power Supply</b>						
$V_{IN}$	Input Voltage Range	$-40^{\circ}C \leq T_A \leq 85^{\circ}C$	2.7		5.5	V
$I_{IN}$	Input Operating Current	EN/SET = IN	1x Mode, $I_{D1} = I_{D2} = I_{D3} = I_{D4} = OFF$	2	4	mA
			1.5x Mode, $I_{D1} = I_{D2} = I_{D3} = I_{D4} = OFF$	6	7.2	
$I_{IN(SHDN)}$	Shutdown Current	EN/SET = GND			1	$\mu A$
$V_{IN(TH)}$	Charge Pump Mode Hysteresis	1x to 1.5x Transition at Any $I_{DX}$		0.15		V
<b>LED Current Sink Outputs</b>						
$I_{D(MAX)}$	D1-D4 Current Accuracy	EN/SET = S <sup>2</sup> C DATA 1	27	30	33	mA
$I_{D(DATA31)}$	D1-D4 Current Accuracy	EN/SET = S <sup>2</sup> C DATA 31		0.5		mA
$\Delta I_{(D_X)/I_{D(AVG)}}$	D1-D4 Current Matching <sup>1</sup>	EN/SET = S <sup>2</sup> C DATA 1, $I_{D1} = I_{D2} = I_{D3} = I_{D4} = 30mA$		$\pm 3$		%
$V_{D(TH)}$	Hysteresis for Mode Change	$I_{D1} = I_{D2} = I_{D3} = I_{D4} = 30mA$ , 1.5x to 1x Mode		0.15	0.25	V
$I_{OUT(MAX)}$	Charge Pump Maximum Output Current	$V_{IN} = 3.0V$ , $V_F = 4.0V$		150		mA
$f_{OSC}$	Clock Frequency			1		MHz
$V_{D(TH)}$	Charge Pump Mode Transition Threshold	EN/SET = IN; $V_{IN} - V_F = 1V$		0.15		V
$t_{SS}$	Charge Pump Startup Time			150		$\mu s$
<b>EN/SET S<sup>2</sup>Cwire Control</b>						
$V_{ENH}$	EN/SET Input High Threshold Voltage		1.4			V
$V_{ENL}$	EN/SET Input Low Threshold Voltage				0.4	V
$I_{EN(LKG)}$	EN Input Leakage Current	EN/SET = IN = 5V	-1		1	$\mu A$
$t_{EN/SET(HI\_MIN)}$	EN/SET Minimum High Time			50		ns
$t_{EN/SET(HI\_MAX)}$	EN/SET Maximum High Time				75	$\mu s$
$t_{EN/SET(LOW)}$	EN/SET Input Low Time		0.3		75	$\mu s$
$t_{EN/SET(OFF)}$	EN/SET Input OFF Timeout				500	$\mu s$
$t_{EN/SET(LAT)}$	EN/SET Input Latch Timeout <sup>3</sup>				500	$\mu s$

1. LED current match is defined as  $100 (I_{DX} - I_{AVG})/I_{AVG}$ .

2. 1x mode output impedance is defined as  $(V_{IN} - V_{OUT})/I_{OUT}$ .

3. If the part has been shut down, the latch time will be 500 $\mu s$  longer for soft start of charge pump.

## High Efficiency 1x/1.5x Charge Pump

### Typical Characteristics

$V_{IN} = 3.6V$ ,  $C_{IN} = C_{OUT} = C_1 = C_2 = 1\mu F$ ;  $T_A = 25^\circ C$ , unless otherwise noted.

**No Load Operating Current vs. Input Voltage (1x Mode)**

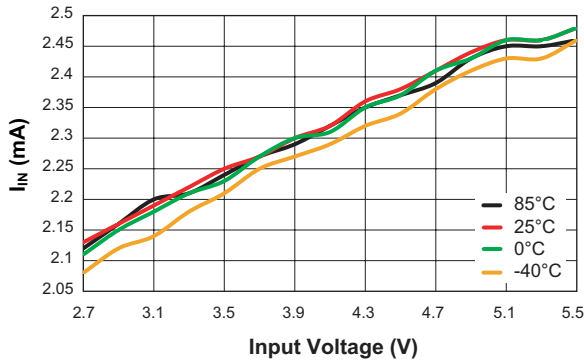

**No Load Operating Current vs. Input Voltage (1.5x Mode)**

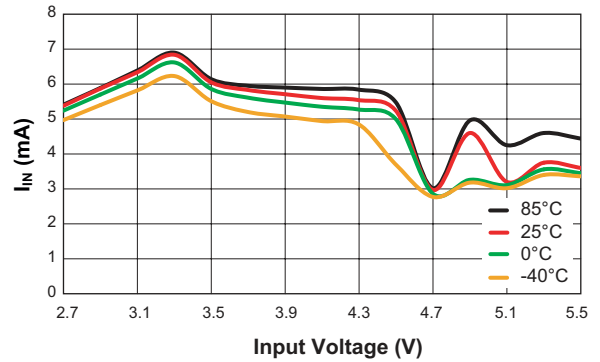

**Backlight Current Matching vs. Temperature (30mA/ch)**

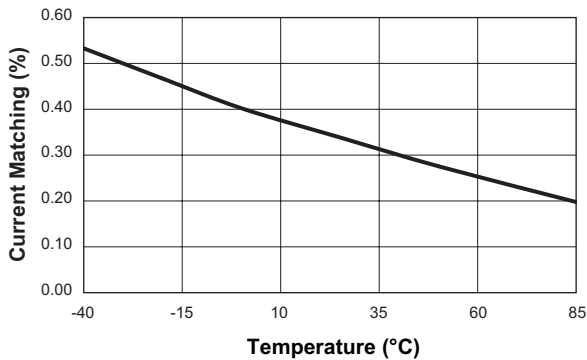

**Efficiency vs. Input Voltage (DATA = 1, 30mA/ch)**

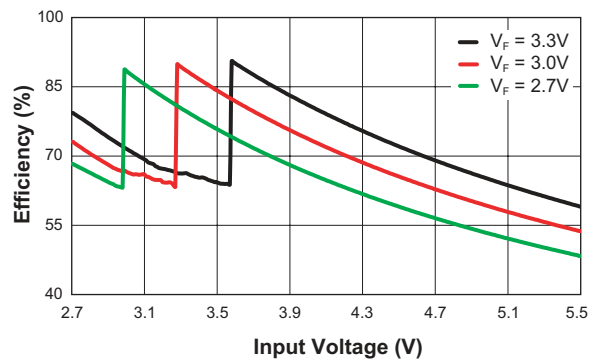

**1.5x Output Voltage vs. Load Current**

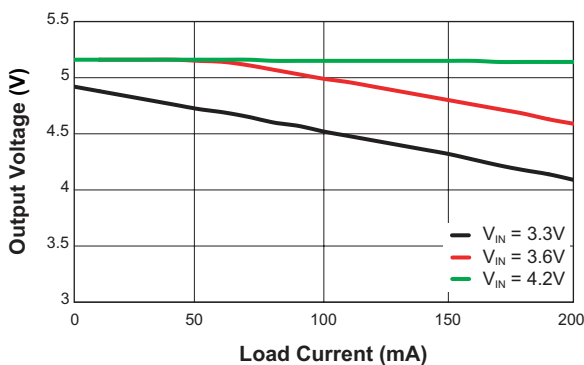

**1.5x Mode Operating Characteristics ( $V_{IN} = 3.3V$ ; 30mA/ch Backlight, 1.5x Mode,  $C_{OUT} = 1\mu F$ )**

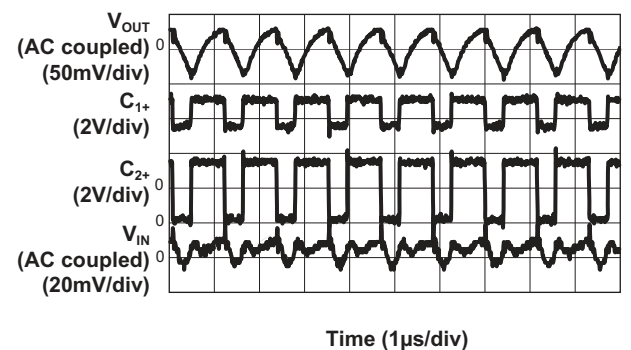

## High Efficiency 1x/1.5x Charge Pump

### Typical Characteristics

$V_{IN} = 3.6V$ ,  $C_{IN} = C_{OUT} = C_1 = C_2 = 1\mu F$ ;  $T_A = 25^\circ C$ , unless otherwise noted.

**EN/SET Input Latch Timeout vs. Input Voltage**

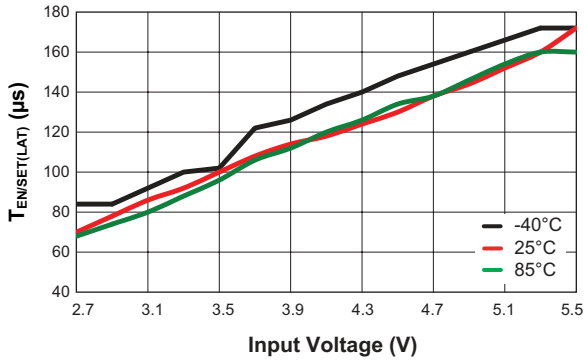

**EN/SET Input Off Timeout vs. Input Voltage**

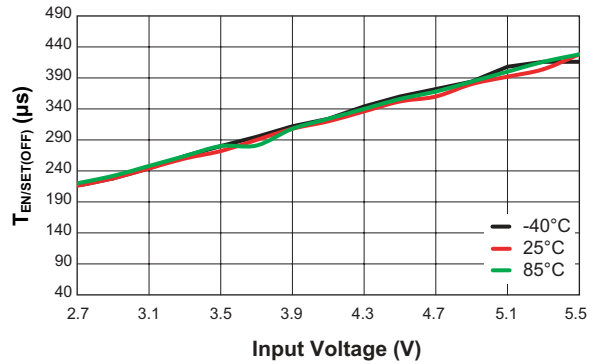

**EN Input High Threshold Voltage vs. Input Voltage**

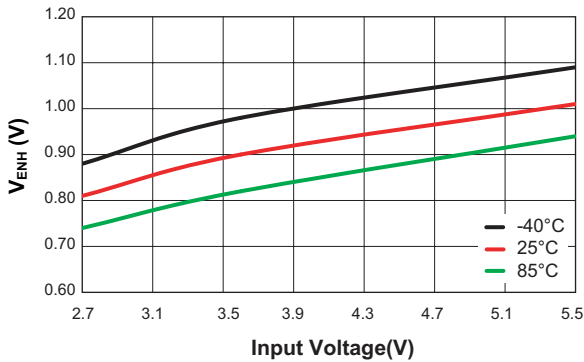

**EN Input Low Threshold Voltage vs. Input Voltage**

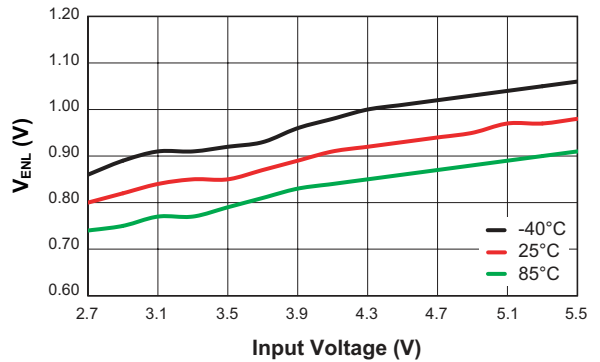

**Turn-On to 1x Mode Backlight**  
( $V_{IN} = 3.6V$ ; 30mA/ch)

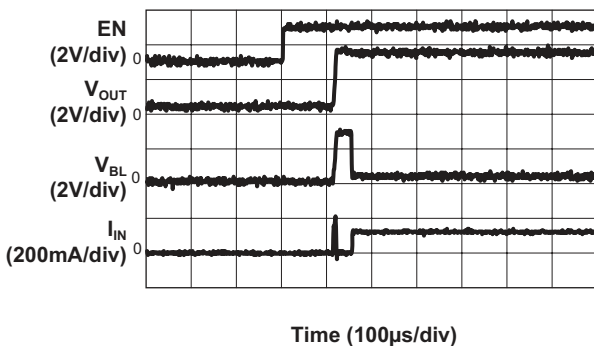

**Turn-On to 1.5x Mode Backlight**  
( $V_{IN} = 3.3V$ ; 30mA/ch)

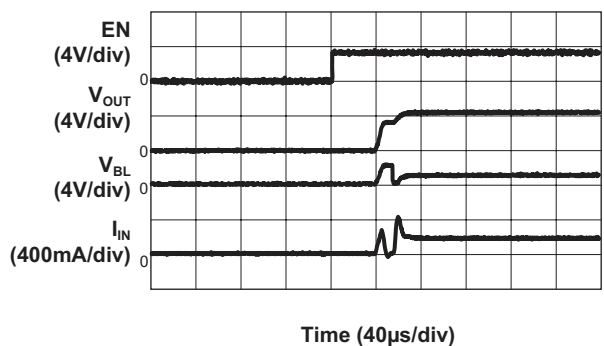

## Typical Characteristics

$V_{IN} = 3.6V$ ,  $C_{IN} = C_{OUT} = C_1 = C_2 = 1\mu F$ ;  $T_A = 25^\circ C$ , unless otherwise noted.

**Turn-Off from 1.5x Mode Backlight**  
( $V_{IN} = 3.3V$ ; 30mA/ch)

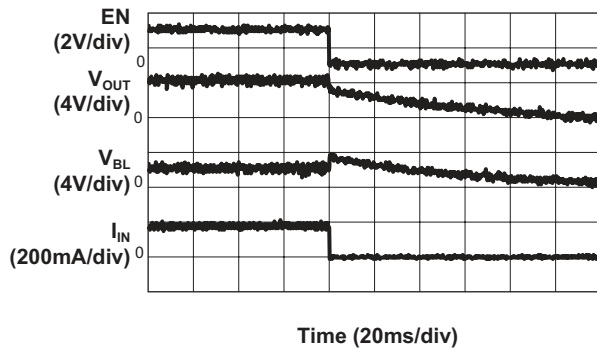

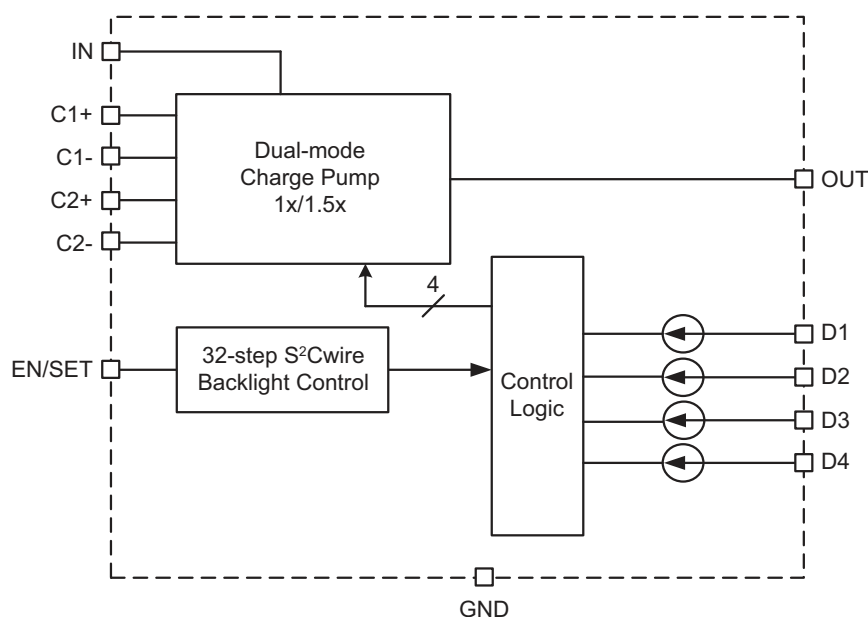
**Functional Block Diagram****Functional Description**

The AAT3351 is a high efficiency charge pump white LEDs driver for portable applications which can drive 4 channels at up to 30mA each.

The current sink magnitude is controlled by the EN/SET serial data S<sup>2</sup>Cwire interface. The interface records rising edges of the EN/SET pin and decodes them into 32 individual current level settings.

**LED Drivers**

The AAT3351 is a fractional charge pump and can multiply the input voltage by 1 or 1.5 times. The charge pump switches at a fixed frequency of 1MHz. The internal-mode-selection-circuit automatically switches the mode between 1x and 1.5x mode based on the input voltage, LED forward voltage, and load current. This mode switching maximizes the efficiency throughout the entire load range. When the input voltage is high enough, the AAT3351 operates in 1x mode to provide maximum efficiency. If the input voltage drops too low to supply programmed LED current when the battery discharges and the voltage decays, 1.5x mode is automatically enabled. When the battery is connected to a charger and the input voltage increases sufficiently, the device will switch back to 1x mode.

**Application Information****Current Level Settings**

LED current level is set via Skyworks' Simple Serial Control (S<sup>2</sup>Cwire) interface in a linear scale. The LED current decreases linearly with each increasing code in steps of approximately 1mA as shown in Table 1 and Figure 1.

S <sup>2</sup> Cwire Data	LED Current (mA)	S <sup>2</sup> Cwire Data	LED Current (mA)
1	30	17	14.5
2	29	18	13.5
3	28	19	12.6
4	27.1	20	11.6
5	26.1	21	10.6
6	25.2	22	9.7
7	24.2	23	8.7
8	23.2	24	7.7
9	22.3	25	6.8
10	21.3	26	5.8
11	20.3	27	4.8
12	19.4	28	3.9
13	18.4	29	2.9
14	17.4	30	1.9
15	16.5	31	1
16	15.5	32	0.5

**Table 1: S<sup>2</sup>Cwire Data vs. LED Current.**



## High Efficiency 1x/1.5x Charge Pump

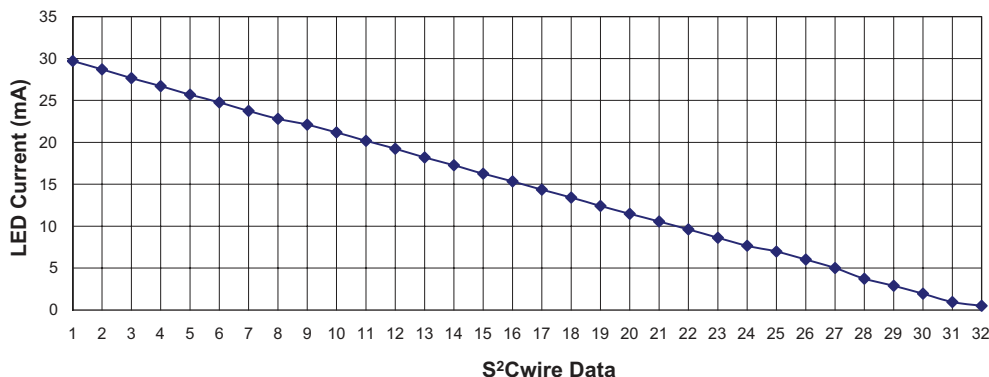

Figure 1: S²Cwire Data vs. LED Current.

### EN/SET Serial Interface

The LED current magnitude is controlled by the EN/SET pin using the S²Cwire interface. The interface records rising edges of the EN/SET pin and decodes them into 32 individual current level settings. Code 1 is full scale, and Code 32 is the lowest setting equal to 500µA. The interface resets back to state 1 after the 32nd clock. The EN/SET counter can be clocked at speeds up to 1MHz, so intermediate states are not visible, but is designed to accommodate a wide range of data rates. The first rising

edge of EN/SET enables the charge pump, which reaches full capacity after the soft-start time  $t_{SS}$ , and initially sets the output LED current to full scale. Once EN/SET has been held in the logic high state for time  $t_{LAT}$  the programmed current is seen at the current sink outputs.

When EN/SET is held low for an amount of time greater than  $t_{OFF}$  the AAT3351 enters into shutdown mode and draws less than 1µA from IN. The internal data register is reset to 0 during shutdown. The EN/SET timing diagram is shown on Figure 2.

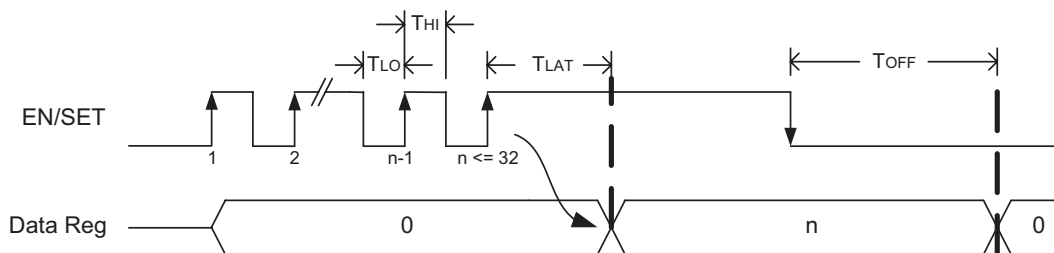

Figure 2: EN/SET Timing Diagram.

**High Efficiency 1x/1.5x Charge Pump****LED Selection**

The AAT3351 is designed to drive white LEDs with forward voltages from 2V to 4.8V. Since D1 through D4 output current sinks are matched with negligible voltage dependence; the LED constant current and brightness will be matched regardless of their forward voltage ( $V_F$ ) levels.

**Test Current/Channel Disable**

Each current sink channel is equipped with a test current function. While it is enabled, the AAT3351 automatically detects the presence of LEDs all the time. Unused channels that are tied to OUT or LED loads that are failed will be automatically disabled.

**Device Switching Noise Performance**

The AAT3351 operates at a fixed frequency of 1MHz to control noise and limit harmonics that can interfere with the RF operation of cellular telephone handsets or other communication devices. Noise injected back to the input pin of the charge pump is 20mV peak-to-peak, typically ten times less than inductor-based DC/DC boost converter white LED backlight solutions. The AAT3351 soft-start feature prevents noise transient effects associated with inrush currents during startup of the charge pump circuit.

**Power Efficiency and Device Evaluation**

The charge pump efficiency discussion in the following sections accounts only for efficiency of the charge pump section itself. Due to the unique circuit architecture and design of the AAT3351, it is very difficult to measure efficiency in terms of a percent value comparing input power over output power. Since the AAT3351 outputs are pure constant current sinks and typically drive individual loads, it is difficult to measure the output voltage for a given output to derive an overall output power measurement.

For any given application, white LED forward voltage levels can differ, yet the output drive current will be maintained as a constant. This makes quantifying output power a difficult task when taken in the context of comparing to other white LED driver circuit topologies. A better way to quantify total device efficiency is to observe the total input power to the device for a given LED current drive level. The best white LED driver for a given application should be based on trade-offs of size, external components count, reliability, operating range,

and total energy usage...*not just % efficiency.*

The AAT3351 efficiency may be quantified under specific conditions and is dependent upon the input voltage and voltage on D1 through D4 for a given constant current setting.

Depending on the combination of  $V_{IN}$  and voltages sensed at the current sinks D1-D4, the device will operate in 1X mode. When any one of the voltages sensed at the current sinks D1-D4 drops below the charge pump mode transient threshold, the device will operate in 1.5X charge pump mode. Each of these modes will yield different efficiency values. Refer to the following two sections for efficiency calculation of each mode.

**1x Mode Efficiency**

The AAT3351's 1x mode is operational at all times and functions alone to enhance device power conversion efficiency when  $V_{IN}$  is higher than the voltage across the load. When in 1x mode, voltage conversion efficiency is defined as output power divided by input power.

An expression for the ideal efficiency ( $\eta$ ) in 1x charge pump mode can be expressed as:

$$\eta = \frac{P_{OUT}}{P_{IN}} = \frac{V_F \cdot I_{OUT}}{V_{IN} \cdot I_{OUT}} \approx \frac{V_F}{V_{IN}}$$

-or-

$$\eta (\%) = 100 \cdot \left( \frac{V_F}{V_{IN}} \right)$$

**1.5x Charge Pump Mode Efficiency**

The AAT3351 contains a fractional charge pump which will boost the input supply voltage when  $V_{IN}$  is less than the voltage required to supply the output. The efficiency ( $\eta$ ) can be simply defined as a linear voltage regulator with an effective output voltage that is equal to one and one half times the input voltage. Efficiency ( $\eta$ ) for an ideal 1.5x charge pump can be calculated by the following equation:

$$\eta = \frac{P_{OUT}}{P_{IN}} = \frac{V_F \cdot I_{OUT}}{V_{IN} \cdot I_{OUT}} = \frac{V_F \cdot I_{OUT}}{V_{IN} \cdot 1.5 \cdot I_{OUT}} \approx \frac{V_F}{1.5 \cdot V_{IN}}$$

-or-

$$\eta (\%) = 100 \cdot \left( \frac{V_F}{1.5 \cdot V_{IN}} \right)$$

**High Efficiency 1x/1.5x Charge Pump****Capacitor Selection**

Careful selection of the four external capacitors  $C_{IN}$ ,  $C_1$ ,  $C_2$ , and  $C_{OUT}$  is important because they will affect turn-on time, output ripple, and transient load performance. Optimum performance will be obtained when low equivalent series resistance (ESR) ceramic capacitors are used. In general, low ESR may be defined as less than 100m $\Omega$ . A value of 1 $\mu$ F for all four capacitors is a good starting point when choosing capacitors. If the LED current sinks are only programmed for low current levels, then the capacitor size may be decreased.

**Capacitor Characteristics**

Ceramic composition capacitors are highly recommended over all other types of capacitors for use with the AAT3351. Ceramic capacitors offer many advantages over their tantalum and aluminum electrolytic counterparts. A ceramic capacitor has very low ESR, is lowest cost, has a smaller PCB footprint, and is non-polarized. Low ESR ceramic capacitors help to maximize charge pump transient response. Since ceramic capacitors are non-polarized, they are not prone to incorrect connection damage.

**Equivalent Series Resistance**

ESR is an important characteristic to consider when selecting a capacitor. ESR is a resistance internal to a capacitor that is caused by the leads, internal connections, size or area, material composition, and ambient temperature. Capacitor ESR is typically measured in milliohms for ceramic capacitors and can range to more than several ohms for tantalum or aluminum electrolytic capacitors.

**Ceramic Capacitor Materials**

Ceramic capacitors less than 0.1 $\mu$ F are typically made from NPO or COG materials. NPO and COG materials have tight tolerance and are stable over temperature. Capacitors with large values are typically composed of X7R, X5R, Z5U, or Y5V dielectric materials.

Large ceramic capacitors, greater than 2.2 $\mu$ F, are often available in low-cost Y5V and Z5U dielectrics, but capacitors greater than 1 $\mu$ F are usually not required for AAT3351 applications.

Capacitor area is another contributor to ESR. Capacitors that are physically larger will have lower ESR when compared to equivalent material but smaller capacitors. These larger devices can improve circuit transient response when compared to an equal value capacitor in a smaller size.

**Evaluation Board Layout**

When designing a PCB for the AAT3351, the key requirements are:

1. Place two flying capacitors  $C_1$  and  $C_2$  as close to the chip as possible; otherwise 1.5x mode performance will be compromised.
2. Place input and output decoupling caps as close to the chip as possible to reduce switching noise and output ripple.

Manufacturer	Part Number	Value ( $\mu$ F)	Voltage (V)	Temperature Coefficient	Case
Murata	GRM219R71C104KA01	0.1	10	X7R	0805
	GRM188R61A105KA61	1	10	X5R	0603
	GRM219R61A475KE19	4.7	10	X5R	0805
AVX	0603ZD105K	1	10	X5R	0603
TDK	C1608X5R1E105K	1	25	X5R	0603
	C1608X5R1A475K	4.7	10	X5R	0603
Taiyo Yuden	LMK107BJ475KA	4.7	10	X5R	0603

**Table 2: Surface Mount Capacitors.**



# AAT3351

## High Efficiency 1x/1.5x Charge Pump

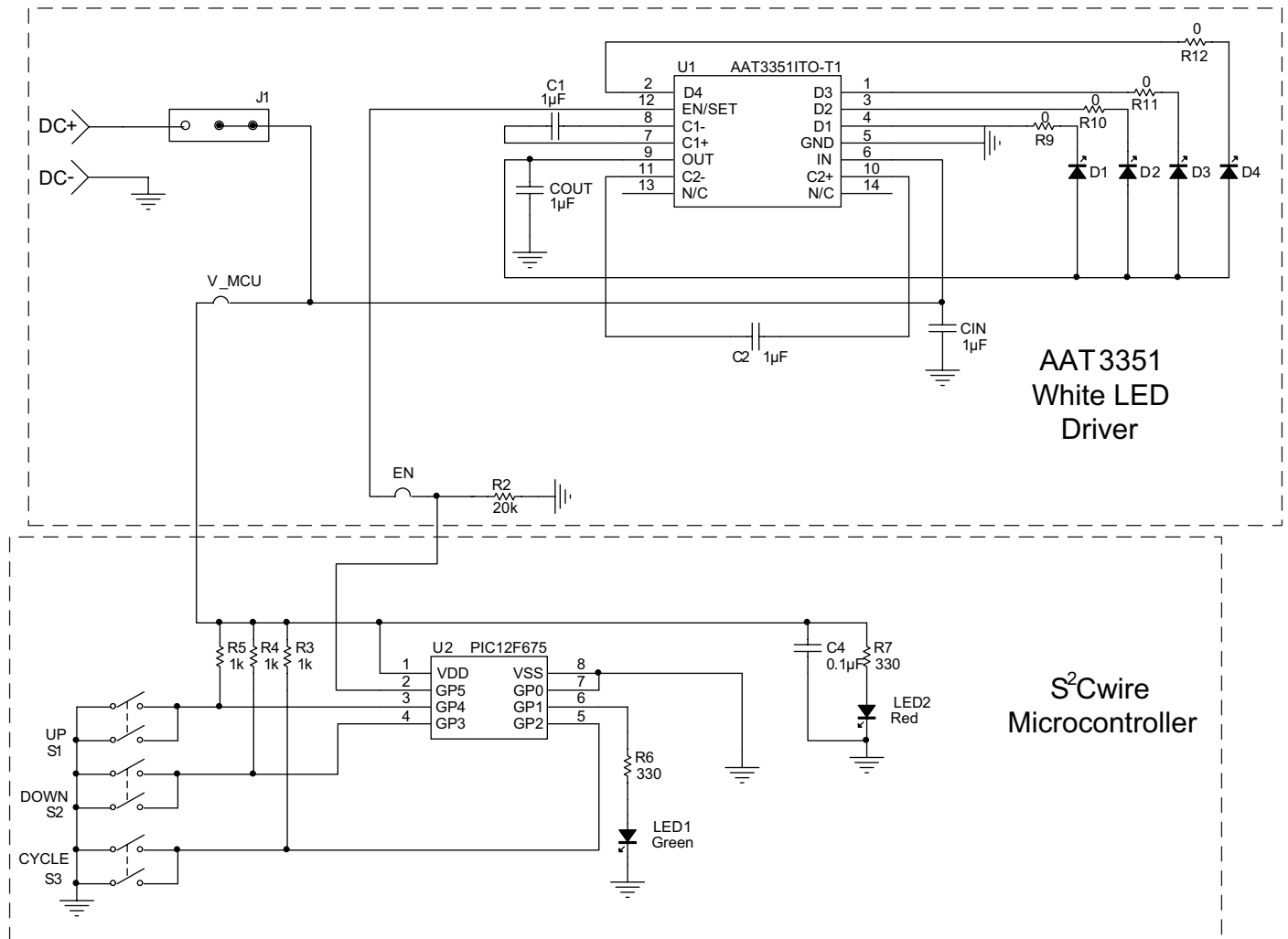
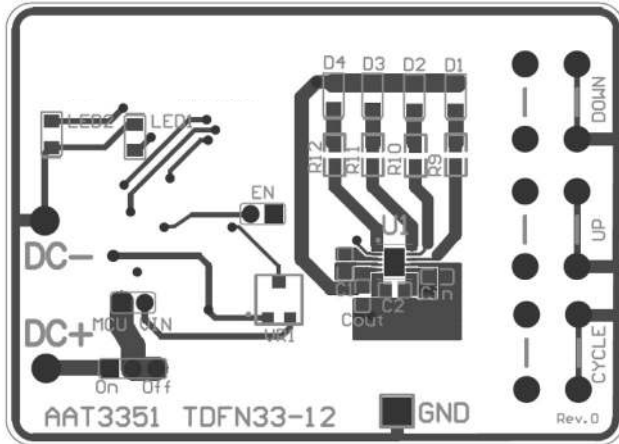
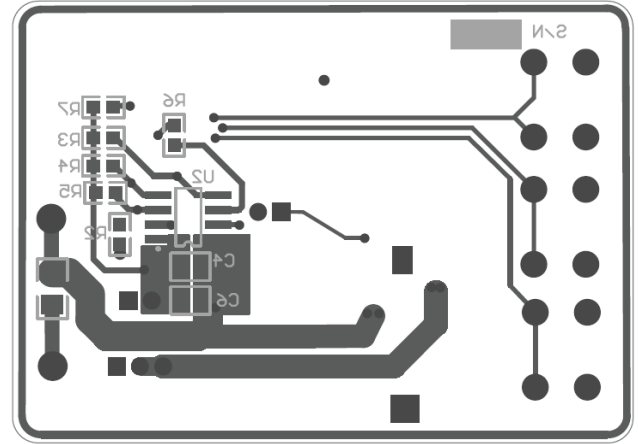

Figure 4: AAT3351ITO Evaluation Board Schematic.

**Evaluation Board Layout**



**Figure 5: AAT3351IWP Evaluation Board Top Side Layout.**



**Figure 6: AAT3351IWP Evaluation Board Bottom Side Layout.**

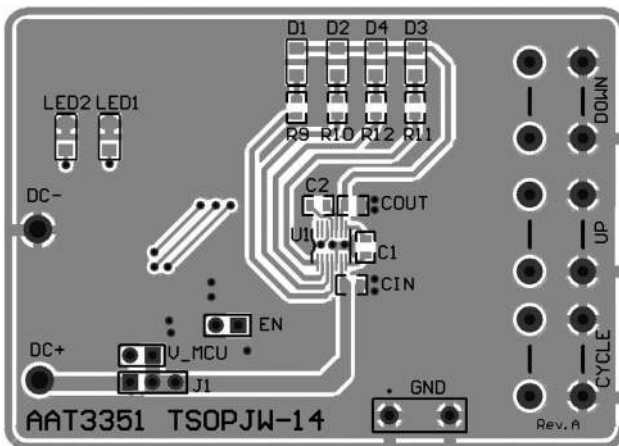

**Figure 7: AAT3351ITO Evaluation Board Top Side Layout.**

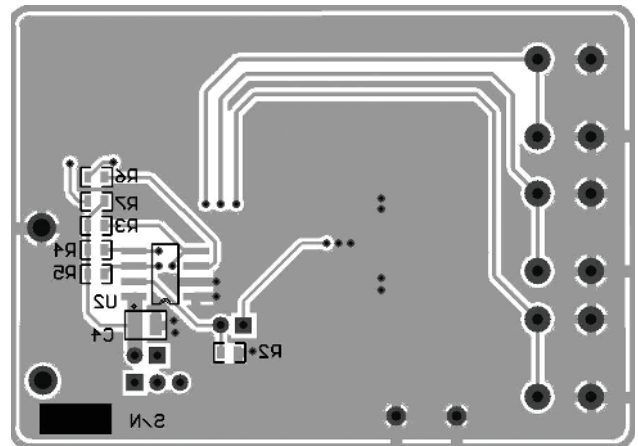

**Figure 8: AAT3351ITO Evaluation Board Bottom Side Layout.**

*High Efficiency 1x/1.5x Charge Pump***AAT3351 Evaluation Board Bill of Materials**

Component	Part Number	Description	Manufacturer
U1	AAT3351IWP-T1/AAT3351ITO-T1	High Efficiency 1X/1.5X Charge Pump for White LED; TDFN33-12/T SOPJW-14 Package	Skyworks
U2	PIC12F675	8-Bit CMOS, FLASH-Based $\mu$ C; 8-Pin MCU	Microchip
C <sub>IN</sub> , C <sub>OUT</sub> , C1, C2	GRM188R61A105KA61	1 $\mu$ F, 10V, X5R, 10%, 0603	Murata
C4	GRM219R71C104KA01	0.1 $\mu$ F, 10V, X7R, 10%, 0805	Murata
C6	GRM219R61A475KE19	4.7 $\mu$ F, 10V, X5R, 10%, 0805	Murata
C8	DNP	Do Not Place	
D1-D4	LW M673	Mini TOPLED White LED	Osram
LED1	21UGC/TR8 Green LED; 0805	LED0 CMD15	Chicago Miniature Lamp
LED2	21SRC/TR8 Red LED; 0805	LED7 CMD15	Chicago Miniature Lamp
R2	Chip Resistor	20K, 1/16W, 1%, 0603	Vishay
R3-R5	Chip Resistor	1K, 1/16W, 1%, 0603	Vishay
R6-R7	Chip Resistor	330, 1/16W, 1%, 0603	Vishay
R8	Chip Resistor	1M, 1/16W, 1%, 0603	Vishay
R9-R12	Chip Resistor	0, 1/16W, 1%, 0603	Vishay
S1, S2, S3	PTS645TL50	Switch Tact, SPST, 5mm	ITT Industries
VR1	EVN-5ESX50B14	10K POT; 3mm Squared SMD	Panasonic-ECG

# AAT3351

## High Efficiency 1x/1.5x Charge Pump

### Ordering Information

Package	Marking <sup>1</sup>	Part Number(Tape & Reel) <sup>2</sup>
TSOPJW-14	8UXYY	<b>AAT3351ITO-T1</b>
TDFN33-12	5YXYY	<b>AAT3351IWP-T1</b>

 Skyworks Green™ products are compliant with all applicable legislation and are halogen-free. For additional information, refer to *Skyworks Definition of Green™*, document number SQ04-0074.

### Package Information<sup>3</sup>

#### TSOPJW-14

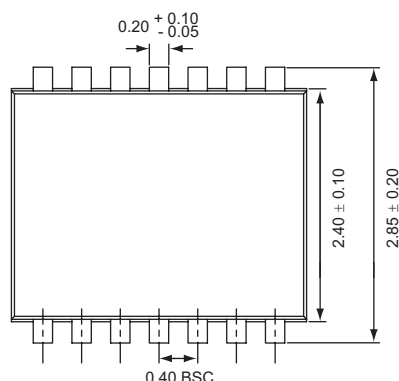

Top View

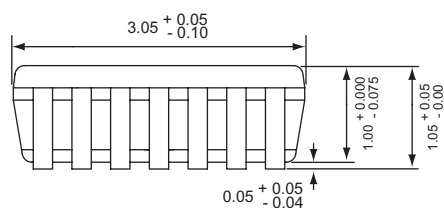

Side View

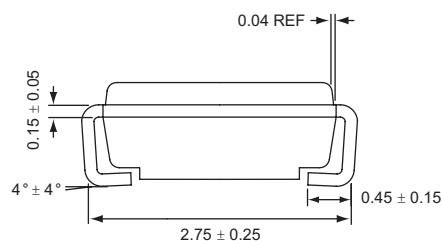

End View

All dimensions in millimeters.

1. XYY = assembly and date code.  
 2. Sample stock is generally held on part numbers listed in **BOLD**.  
 3. The leadless package family, which includes QFN, TQFN, DFN, TDFN and STDN, has exposed copper (unplated) at the end of the lead terminals due to the manufacturing process. A solder fillet at the exposed copper edge cannot be guaranteed and is not required to ensure a proper bottom solder connection.



# DATA SHEET

# AAT3351

## High Efficiency 1x/1.5x Charge Pump

### TDFN33-12

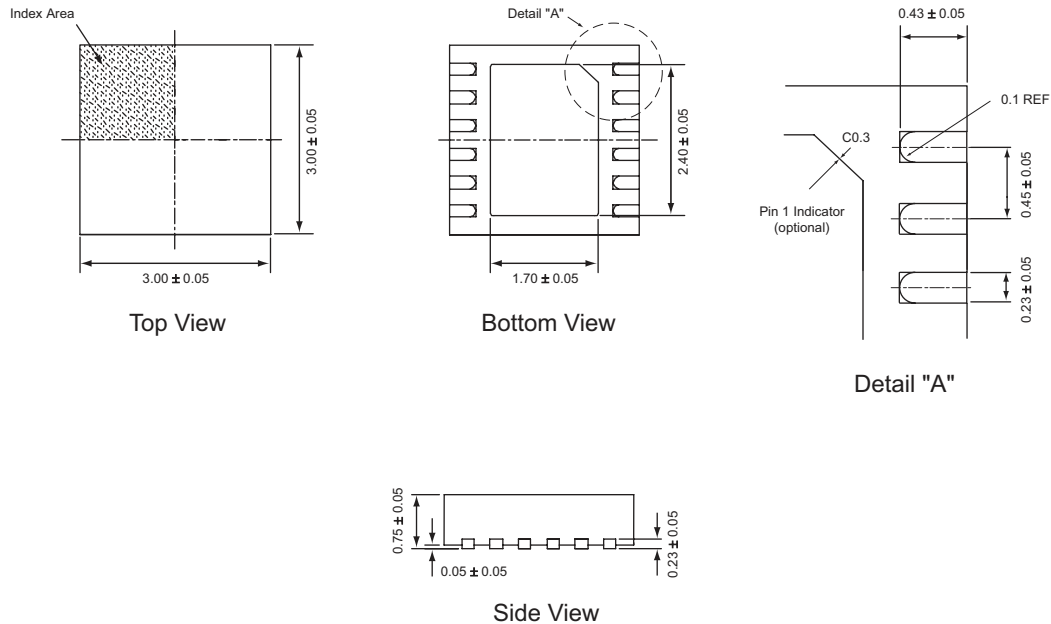

All dimensions in millimeters.

Copyright © 2012 Skyworks Solutions, Inc. All Rights Reserved.

Information in this document is provided in connection with Skyworks Solutions, Inc. ("Skyworks") products or services. These materials, including the information contained herein, are provided by Skyworks as a service to its customers and may be used for informational purposes only by the customer. Skyworks assumes no responsibility for errors or omissions in these materials or the information contained herein. Skyworks may change its documentation, products, services, specifications or product descriptions at any time, without notice. Skyworks makes no commitment to update the materials or information and shall have no responsibility whatsoever for conflicts, incompatibilities, or other difficulties arising from any future changes.

No license, whether express, implied, by estoppel or otherwise, is granted to any intellectual property rights by this document. Skyworks assumes no liability for any materials, products or information provided hereunder, including the sale, distribution, reproduction or use of Skyworks products, information or materials, except as may be provided in Skyworks Terms and Conditions of Sale.

THE MATERIALS, PRODUCTS AND INFORMATION ARE PROVIDED "AS IS" WITHOUT WARRANTY OF ANY KIND, WHETHER EXPRESS, IMPLIED, STATUTORY, OR OTHERWISE, INCLUDING FITNESS FOR A PARTICULAR PURPOSE OR USE, MERCHANTABILITY, PERFORMANCE, QUALITY OR NON-INFRINGEMENT OF ANY INTELLECTUAL PROPERTY RIGHT; ALL SUCH WARRANTIES ARE HEREBY EXPRESSLY DISCLAIMED. SKYWORKS DOES NOT WARRANT THE ACCURACY OR COMPLETENESS OF THE INFORMATION, TEXT, GRAPHICS OR OTHER ITEMS CONTAINED WITHIN THESE MATERIALS. SKYWORKS SHALL NOT BE LIABLE FOR ANY DAMAGES, INCLUDING BUT NOT LIMITED TO ANY SPECIAL, INDIRECT, INCIDENTAL, STATUTORY, OR CONSEQUENTIAL DAMAGES, INCLUDING WITHOUT LIMITATION, LOST REVENUES OR LOST PROFITS THAT MAY RESULT FROM THE USE OF THE MATERIALS OR INFORMATION, WHETHER OR NOT THE RECIPIENT OF MATERIALS HAS BEEN ADVISED OF THE POSSIBILITY OF SUCH DAMAGE.

Skyworks products are not intended for use in medical, lifesaving or life-sustaining applications, or other equipment in which the failure of the Skyworks products could lead to personal injury, death, physical or environmental damage. Skyworks customers using or selling Skyworks products for use in such applications do so at their own risk and agree to fully indemnify Skyworks for any damages resulting from such improper use or sale.

Customers are responsible for their products and applications using Skyworks products, which may deviate from published specifications as a result of design defects, errors, or operation of products outside of published parameters or design specifications. Customers should include design and operating safeguards to minimize these and other risks. Skyworks assumes no liability for applications assistance, customer product design, or damage to any equipment resulting from the use of Skyworks products outside of stated published specifications or parameters.

Skyworks, the Skyworks symbol, and "Breakthrough Simplicity" are trademarks or registered trademarks of Skyworks Solutions, Inc., in the United States and other countries. Third-party brands and names are for identification purposes only, and are the property of their respective owners. Additional information, including relevant terms and conditions, posted at [www.skyworksinc.com](http://www.skyworksinc.com), are incorporated by reference.