

| | | |
|--|---|--------|
| GlobTek, Inc. www.globtek.com 186 Veterans Drive, Northvale, NJ 07647 Tel. (201) 784-1000 Fax (201) 784-0111 | Drawing Title: GTM96600-6019-T3, ICT / ITE / Medical Power Supply/Class 2/Household Power Supply, Efficiency Level: USA DOE Level VI / Eco-design Directive 2009/125/EC, (EU) 2019/1782, Case Color/Style: GlobTek Black, Desktop/External, Regulated Switchmode AC-DC Power Supply AC Adaptor, Input Rating: 100-240V~, 50-60Hz, IEC 60320/C14 , Output Rating: 60W, 19.0V@3.15A, Output Configuration: 1200 mm, 16 (Large ground 40/0.20) OD:4.3mm/1C + Shield Cond, UL 1185, Female Barrel 5.5*2.5*13mm, Right Angle High Retention Internal Spring Clip & Locking Notch, Ferrite: Core Size: 26 x 28.5 x 16, GlobTek Black, GT Cord # C51826, Pin Out: Center Positive (+V), symbol compliant with IEC 60417 symbol no. 5926, Blades/Input Cord: (Order Separately), Approvals: LPS 60950; India BIS; IP41; CB 60335; Fuse 60335; 230V CoC Tier 2; ETL; EAC; South Africa; UL 1310; cETLus 60950-1; cETLus 60601-1-11; CB 62368; UKCA; Conforms to 62368-1; NRCAN (5V only); Morocco; NOM (5V only); UL 1310; Korea (21.0V-28.0V Only); Singapore (19V); NOM (12V only); Malaysia; IRAM; Taiwan BSMI (24V only); 61558-1; IEC 61558-1; RCM; S-Mark 60950; IRAM; Ukraine; CB 60950; Class I; ETL 60950; CCC; CB 60601-1; S-Mark IEC/EN 60601-1; cETLus 60601-1; cULus (5V only); Taiwan BSMI (5V, 6.3V,12V only); Korea (6.3V Only); PSE; PSE; PSE; WEEE; V | |
| | Model No. GTM96600-6019-T3 | |
| | Part No./Ordering No. TR9CZ3157LR13IMR6BF2Z | Rev A1 |

In Addition to GlobTek Inc.'s renewed ISO9001:2015 - Quality Management System Certification, GlobTek Inc. is now certified to:

ISO13485:2016 - Medical Devices Quality Management System Certification

ISO14001:2015 - Environmental Management System Certification

ISO Certificates are available online at <https://www.globtek.com/iso-certificates/>

The acceptance of this specification and use of the product described in this document indicates the acceptance and binding of the customer to Globtek TERMS AND CONDITIONS (attached to the end of this document), which supersede all other agreements, terms, and conditions (<https://en.globtek.com/terms-and-conditions/>).

The purchaser of this product (Customer) agrees that it is their sole responsibility to determine suitability/fitness of the product described in this specification for their application and to take precautions for protection against any hazards attendant to the handling and use of the product.

Footnote:

GlobTek Inc. will not be liable for the safety and performance of these power supplies/battery packs if unauthorized access and repair occurs. End user should consult applicable UL, CSA or EN standards for proper installation instruction.

Limitation of Use:

GlobTek products are intended for use with commercial, medical, and/or industrial equipment only. GlobTek product are not authorized for use as mission critical components in life support hazardous environment, nuclear or aircraft applications without prior written approval from the CEO of GlobTek Inc.

Contents of this document are subject to change without prior notice.

Customer Approval of Specification:

Please approve, sign and send back to GlobTek so we can complete order processing.

A delay in receipt of this form will delay delivery schedule.

| | |
|---------------------------------------|--|
| Company Name: _____ | Customer P/N: _____ |
| Quote Number: _____ | Date: _____ |
| Authorized Representative Name: _____ | Authorized Representative Signature: _____ |

| | | |
|--|---|--------|
| GlobTek, Inc. www.globtek.com 186 Veterans Drive, Northvale, NJ 07647 Tel. (201) 784-1000 Fax (201) 784-0111 | Drawing Title: GTM96600-6019-T3, ICT / ITE / Medical Power Supply/Class 2/Household Power Supply, Efficiency Level: USA DOE Level VI / Eco-design Directive 2009/125/EC, (EU) 2019/1782, Case Color/Style: GlobTek Black, Desktop/External, Regulated Switchmode AC-DC Power Supply AC Adaptor, Input Rating: 100-240V~, 50-60Hz, IEC 60320/C14 , Output Rating: 60W, 19.0V@3.15A, Output Configuration: 1200 mm, 16 (Large ground 40/0.20) OD:4.3mm/1C + Shield Cond, UL 1185, Female Barrel 5.5*2.5*13mm, Right Angle High Retention Internal Spring Clip & Locking Notch, Ferrite: Core Size: 26 x 28.5 x 16, GlobTek Black, GT Cord # C51826, Pin Out: Center Positive (+V), symbol compliant with IEC 60417 symbol no. 5926, Blades/Input Cord: (Order Separately), Approvals: LPS 60950; India BIS; IP41; CB 60335; Fuse 60335; 230V CoC Tier 2; ETL; EAC; South Africa; UL 1310; cETLus 60950-1; cETLus 60601-1-11; CB 62368; UKCA; Conforms to 62368-1; NRCAN (5V only); Morocco; NOM (5V only); UL 1310; Korea (21.0V-28.0V Only); Singapore (19V); NOM (12V only); Malaysia; IRAM; Taiwan BSMI (24V only); 61558-1; IEC 61558-1; RCM; S-Mark 60950; IRAM; Ukraine; CB 60950; Class I; ETL 60950; CCC; CB 60601-1; S-Mark IEC/EN 60601-1; cETLus 60601-1; cULus (5V only); Taiwan BSMI (5V, 6.3V,12V only); Korea (6.3V Only); PSE; PSE; PSE; WEEE; V | |
| | Model No. GTM96600-6019-T3 | |
| | Part No./Ordering No. TR9CZ3157LR13IMR6BFZ | Rev A1 |

REVISION HISTORY

| REV | DESCRIPTION | SUB | DATE | APPROVED |
|-----|--|-----|------------|----------|
| A1 | Update label drawing in the deviation: add UKCA, CCC, Transformers symbols | QA | 06/09/2023 | QA |
| A | Initial release | QA | 05/25/2022 | QA |

POWER SUPPLY INFORMATION

| | |
|--------------------------------|---|
| TYPE | Desktop/External |
| TECHNOLOGY | Regulated Switchmode AC-DC Power Supply AC Adaptor |
| CASE COLOR | GlobTek Black |
| NAMEPLATE RATED INPUT | 100-240V~, 50-60Hz, 1.5A |
| INPUT CONFIG | IEC 60320/C14 |
| WATTS | 60.00 |
| VOLTS OUT | 19.0 |
| CURRENT OUT (Amps) | 3.15 |
| BLADE/CORD INCLUDED | None (Order Separately) |
| BLADE/CORD INSTALLED | None :(Order Separately) |
| INGRESS PROTECTION | IP41 |
| GROUNDING CONFIGURATION | (F2) Isolated Functional Earth for GTM96 series, Improved EMC |
| EFFICIENCY LEVEL | USA DOE Level VI / Eco-design Directive 2009/125/EC, (EU) 2019/1782 - Europe Code of Conduct on Energy Efficiency of External Power Supplies - Version 5 |
| OUTPUT CONFIGURATION | 1200 mm, 16 (Large ground 40/0.20) OD:4.3mm/1C + Shield Cond, UL 1185, Female Barrel 5.5*2.5*13mm, Right Angle High Retention Internal Spring Clip & Locking Notch, Ferrite: Core Size: 26 x 28.5 x 16, GlobTek Black, GT Cord # C51826 |
| OVERMOLDED | Yes |
| OUTPUT CONNECTOR GENDER | Female |
| CONNECTOR PIN OUT | Center Positive (+V), symbol compliant with IEC 60417 symbol no. 5926 |
| LABEL SPECS | ISO 15223 medical device compliant label - see deviations,L-1622 |
| SPECIAL BARCODE LABEL MATERIAL | No |
| PACK SPEC | Standard DT, Cellular packaging |
| USER MANUAL | |

PROPRIETARY INFORMATION

| | | |
|---|--|---------------|
| <p>GlobTek, Inc. www.globtek.com 186 Veterans Drive, Northvale, NJ 07647 Tel. (201) 784-1000 Fax (201) 784-0111</p> | <p>Drawing Title: GTM96600-6019-T3, ICT / ITE / Medical Power Supply/Class 2/Household Power Supply, Efficiency Level: USA DOE Level VI / Eco-design Directive 2009/125/EC, (EU) 2019/1782, Case Color/Style: GlobTek Black, Desktop/External, Regulated Switchmode AC-DC Power Supply AC Adaptor, Input Rating: 100-240V~, 50-60Hz, IEC 60320/C14 , Output Rating: 60W, 19.0V@3.15A, Output Configuration: 1200 mm, 16 (Large ground 40/0.20) OD:4.3mm/1C + Shield Cond, UL 1185, Female Barrel 5.5*2.5*13mm, Right Angle High Retention Internal Spring Clip & Locking Notch, Ferrite: Core Size: 26 x 28.5 x 16, GlobTek Black, GT Cord # C51826, Pin Out: Center Positive (+V), symbol compliant with IEC 60417 symbol no. 5926, Blades/Input Cord: (Order Separately), Approvals: LPS 60950; India BIS; IP41; CB 60335; Fuse 60335; 230V CoC Tier 2; ETL; EAC; South Africa; UL 1310; cETLus 60950-1; cETLus 60601-1-11; CB 62368; UKCA; Conforms to 62368-1; NRCAN (5V only); Morocco; NOM (5V only); UL 1310; Korea (21.0V-28.0V Only); Singapore (19V); NOM (12V only); Malaysia; IRAM; Taiwan BSMI (24V only); 61558-1; IEC 61558-1; RCM; S-Mark 60950; IRAM; Ukraine; CB 60950; Class I; ETL 60950; CCC; CB 60601-1; S-Mark IEC/EN 60601-1; cETLus 60601-1; cULus (5V only); Taiwan BSMI (5V, 6.3V,12V only); Korea (6.3V Only); PSE; PSE; PSE; WEEE; V</p> | |
| | <p>Model No. GTM96600-6019-T3</p> | |
| | <p>Part No./Ordering No. TR9CZ3157LR13IMR6BF2Z</p> | <p>Rev A1</p> |

Notes/Modifications/Customizations (notes in this section supersede the values shown in the standard spec)

DIMENSIONS ARE IN MM UNLESS SPECIFIED OTHERWISE



- Special treatment required to meet IP42!
- Mark IP42 on the main label (not IP41):
- Assembly built in accordance with changes described in “RFP RFI-1331401-1 Change Impact Assessment Report TR9CZ3157LR13IMR6BF2 19-May-2022.docx”



| | | |
|--|---|--------|
| GlobTek, Inc. www.globtek.com 186 Veterans Drive, Northvale, NJ 07647 Tel. (201) 784-1000 Fax (201) 784-0111 | Drawing Title: GTM96600-6019-T3, ICT / ITE / Medical Power Supply/Class 2/Household Power Supply, Efficiency Level: USA DOE Level VI / Eco-design Directive 2009/125/EC, (EU) 2019/1782, Case Color/Style: GlobTek Black, Desktop/External, Regulated Switchmode AC-DC Power Supply AC Adaptor, Input Rating: 100-240V~, 50-60Hz, IEC 60320/C14 , Output Rating: 60W, 19.0V@3.15A, Output Configuration: 1200 mm, 16 (Large ground 40/0.20) OD:4.3mm/1C + Shield Cond, UL 1185, Female Barrel 5.5*2.5*13mm, Right Angle High Retention Internal Spring Clip & Locking Notch, Ferrite: Core Size: 26 x 28.5 x 16, GlobTek Black, GT Cord # C51826, Pin Out: Center Positive (+V), symbol compliant with IEC 60417 symbol no. 5926, Blades/Input Cord: (Order Separately), Approvals: LPS 60950; India BIS; IP41; CB 60335; Fuse 60335; 230V CoC Tier 2; ETL; EAC; South Africa; UL 1310; cETLus 60950-1; cETLus 60601-1-11; CB 62368; UKCA; Conforms to 62368-1; NRCAN (5V only); Morocco; NOM (5V only); UL 1310; Korea (21.0V-28.0V Only); Singapore (19V); NOM (12V only); Malaysia; IRAM; Taiwan BSMI (24V only); 61558-1; IEC 61558-1; RCM; S-Mark 60950; IRAM; Ukraine; CB 60950; Class I; ETL 60950; CCC; CB 60601-1; S-Mark IEC/EN 60601-1; cETLus 60601-1; cULus (5V only); Taiwan BSMI (5V, 6.3V,12V only); Korea (6.3V Only); PSE; PSE; PSE; WEEE; V | |
| | Model No. GTM96600-6019-T3 | |
| | Part No./Ordering No. TR9CZ3157LR13IMR6BF2Z | Rev A1 |

ELECTRICAL SPECIFICATIONS

Input

| | |
|----------------------|--|
| Input Voltage: | Specified: 90-264VAC, Nameplate: 100-240VAC 100% rated load current for 90-264VAC 85% rated load current for 85-264VAC 100% rated load current for 110-370VDC |
| Input Frequency: | Specified: 47-63Hz, Nameplate: 50-60Hz |
| No Load Input Power: | <75mW @ 230VAC (EU CoC Tier 2 compliant) for ≤ 49W rating <150mW @ 230VAC (EU CoC Tier 2 compliant) for > 49W rating |
| Inrush Current: | 30A/60A max. (cold start @ 115V/230VAC) |
| Efficiency: | DoE Level VI and EU CoC Tier 2 compliant |

Output

| | |
|---------------------|--|
| Turn-on Delay: | 1 second max. @ 115VAC and full load |
| Output Regulation: | ± 5% (measured at output connector) |
| Line Regulation: | ± 0.5% typ. (measured at output connector) |
| Ripple: | 1% or 100mV, whichever is greater (using a 47µF low-ESR cap + 0.1µF ceramic capacitor, measured @ 20MHz BW, at output connector) |
| Transient Response: | 5% max. deviation, 1ms typ. recovery time (with 40% to 70% load step) |
| Hold-up Time: | 8ms typ. (nominal input voltage and full load) |
| Power Indicator: | Green LED |

Protections

| | |
|------------------------------|---|
| Input Protection: | MOV transient suppressor, input line fusing |
| Over-Current Protection: | 110 - 160% of rated output current, auto-restart, current limit range determined by normal output power rating, not de-rated power rating |
| Short-Circuit Protection: | Auto-restart |
| Over-Voltage Protection: | 110 - 130%, latched off, cycle AC to reset |
| Over-Temperature Protection: | On-chip temperature sensor (integrated in primary-side switching controller), shut down at Tj = ~140°C, latched off, cycle AC to reset |

Environmental

PROPRIETARY INFORMATION

| | | |
|--|---|--------|
| GlobTek, Inc. www.globtek.com 186 Veterans Drive, Northvale, NJ 07647 Tel. (201) 784-1000 Fax (201) 784-0111 | Drawing Title: GTM96600-6019-T3, ICT / ITE / Medical Power Supply/Class 2/Household Power Supply, Efficiency Level: USA DOE Level VI / Eco-design Directive 2009/125/EC, (EU) 2019/1782, Case Color/Style: GlobTek Black, Desktop/External, Regulated Switchmode AC-DC Power Supply AC Adaptor, Input Rating: 100-240V~, 50-60Hz, IEC 60320/C14 , Output Rating: 60W, 19.0V@3.15A, Output Configuration: 1200 mm, 16 (Large ground 40/0.20) OD:4.3mm/1C + Shield Cond, UL 1185, Female Barrel 5.5*2.5*13mm, Right Angle High Retention Internal Spring Clip & Locking Notch, Ferrite: Core Size: 26 x 28.5 x 16, GlobTek Black, GT Cord # C51826, Pin Out: Center Positive (+V), symbol compliant with IEC 60417 symbol no. 5926, Blades/Input Cord: (Order Separately), Approvals: LPS 60950; India BIS; IP41; CB 60335; Fuse 60335; 230V CoC Tier 2; ETL; EAC; South Africa; UL 1310; cETLus 60950-1; cETLus 60601-1-11; CB 62368; UKCA; Conforms to 62368-1; NRCAN (5V only); Morocco; NOM (5V only); UL 1310; Korea (21.0V-28.0V Only); Singapore (19V); NOM (12V only); Malaysia; IRAM; Taiwan BSMI (24V only); 61558-1; IEC 61558-1; RCM; S-Mark 60950; IRAM; Ukraine; CB 60950; Class I; ETL 60950; CCC; CB 60601-1; S-Mark IEC/EN 60601-1; cETLus 60601-1; cULus (5V only); Taiwan BSMI (5V, 6.3V,12V only); Korea (6.3V Only); PSE; PSE; PSE; WEEE; V | |
| | Model No. GTM96600-6019-T3 | |
| | Part No./Ordering No. TR9CZ3157LR13IMR6BF2Z | Rev A1 |

| | |
|------------------------|--|
| MTBF: | 1,500,000 hours @ 25°C ambient, full load (Telcordia SR-332, Issue 3) |
| Operating Temperature: | -20°C to 40°C (full load) |
| Storage Temperature: | -30°C to 80°C |
| Humidity: | 0% to 95% relative humidity, non-condensing |
| Altitude: | 5000m |
| Cooling: | Convection |
| RoHS: | Complies with EU 2011/65/EU and China SJ/T 11363-2006 |
| Note 1: | Regarding operating temperature a. See below de-rating table for output power capability at alternate temperature b. Extended low-end temperature range available as a custom option |

Safety

| | |
|-------------------------------|--|
| Dielectric Withstand Voltage: | 4000VAC or 5656VDC from input to output 3000VAC or 4242VDC from input to earth (Class I models only) |
| Touch Current: | Class I: 20µA max. Class II: 85µA max. Class II F2: 20µA max. |
| Earth Leakage Current | Class I: 300µA max. Class II: N/A |
| Means of Protection: | 2 x MOPP |
| Output Isolation Options: | Class I: C6 or C14 inlet (output negative tied to Earth contact) Class II: C8 or C18 inlet Class II FE: C6 or C14 inlet (output isolated from Earth contact) Review isolation options by reading our white paper PSU Isolation and Identity . |
| Earth Continuity Test: | < 0.1Ω between earth pin (on AC inlet) and PCB termination point (Class I models only) |
| Compliant Standards: | See listing at end of this datasheet for specific standards |

EMC

| | | |
|--|---|--------|
| GlobTek, Inc. www.globtek.com 186 Veterans Drive, Northvale, NJ 07647 Tel. (201) 784-1000 Fax (201) 784-0111 | Drawing Title: GTM96600-6019-T3, ICT / ITE / Medical Power Supply/Class 2/Household Power Supply, Efficiency Level: USA DOE Level VI / Eco-design Directive 2009/125/EC, (EU) 2019/1782, Case Color/Style: GlobTek Black, Desktop/External, Regulated Switchmode AC-DC Power Supply AC Adaptor, Input Rating: 100-240V~, 50-60Hz, IEC 60320/C14 , Output Rating: 60W, 19.0V@3.15A, Output Configuration: 1200 mm, 16 (Large ground 40/0.20) OD:4.3mm/1C + Shield Cond, UL 1185, Female Barrel 5.5*2.5*13mm, Right Angle High Retention Internal Spring Clip & Locking Notch, Ferrite: Core Size: 26 x 28.5 x 16, GlobTek Black, GT Cord # C51826, Pin Out: Center Positive (+V), symbol compliant with IEC 60417 symbol no. 5926, Blades/Input Cord: (Order Separately), Approvals: LPS 60950; India BIS; IP41; CB 60335; Fuse 60335; 230V CoC Tier 2; ETL; EAC; South Africa; UL 1310; cETLus 60950-1; cETLus 60601-1-11; CB 62368; UKCA; Conforms to 62368-1; NRCAN (5V only); Morocco; NOM (5V only); UL 1310; Korea (21.0V-28.0V Only); Singapore (19V); NOM (12V only); Malaysia; IRAM; Taiwan BSMI (24V only); 61558-1; IEC 61558-1; RCM; S-Mark 60950; IRAM; Ukraine; CB 60950; Class I; ETL 60950; CCC; CB 60601-1; S-Mark IEC/EN 60601-1; cETLus 60601-1; cULus (5V only); Taiwan BSMI (5V, 6.3V,12V only); Korea (6.3V Only); PSE; PSE; PSE; WEEE; V | |
| | Model No. GTM96600-6019-T3 | |
| | Part No./Ordering No. TR9CZ3157LR13IMR6BF2Z | Rev A1 |

| | |
|---|--|
| Applicable Standards: | Medical: EN60601-1-2, 4th edition Emissions: EN55032, EN61000-6-3, EN61000-6-4, CISPR11, CISPR22 Immunity: EN55024, EN61000-6-1, EN61000-6-2 |
| Conducted Emissions: | Class B, FCC Part 15, Class B (with resistive load) |
| Radiated Emissions: | Class B, FCC Part 15, Class B (with resistive load) |
| Harmonic Current Voltage Distortion: | EN61000-3-2, Class A |
| Voltage Fluctuations/Flicker: | EN61000-3-3 |
| Electrostatic Discharge (ESD) Immunity: | EN61000-4-2, 10KV contact discharge, 20KV air discharge |
| Radiated RF Immunity: | EN61000-4-3, 10V/m 80-1000MHz, 3V/m 1-2.7GHz, 80% 1KHz AM |
| EFT/Burst Immunity: | EN61000-4-4, 4KV/100kHz. |
| Line Surge Immunity: | EN61000-4-5, 2KV differential, 4KV common-mode |
| Conducted RF Immunity: | EN61000-4-6, 3VRMS, 80% 1KHz AM |
| Power Frequency Magnetic Field Immunity: | EN61000-4-8, 3A/m |
| Voltage Dip Immunity: | EN61000-4-11 |

Enclosure

| | |
|-------------------------------------|--|
| Housing: | High impact plastic, 94V0 polycarbonate, non-vented |
| AC Input Mechanical Options: | Desktop: C6, C7, C14, or C18 inlet Hybrid: Desktop inlet or changeable blades for wall-plug-in style, Class I or Class II input |
| Markings: | Label and/or pad printed and/or laser-etched into case |

Special Options

1. Removal of LED (cost reduction or aesthetic purpose)
2. Custom cordsets, various cordage types, and connector types
3. Custom markings
4. Short term output surge capability for motors or other high peak current loads. (Available up to 120W for 1 second at nameplate voltage range. Higher levels possible for limited input voltage range, or larger allowed voltage dip.)
5. Reduced leakage current
6. Tightened output voltage tolerance
7. Reduced output ripple level
8. Reduced output power rating
9. High reliability PCB laminate with plated through-holes for IPC610 Class 2 compliance
10. Low temperature option, down to -40°C
11. Special housing and cordset colors
12. "Back EMF" upgrade, for motor loads and other high inductance applications with reverse energy flow requirements
13. Improved ingress protection (IP) rating

Output Connectors

| | |
|---|--|
| <p>GlobTek, Inc. www.globtek.com 186 Veterans Drive, Northvale, NJ 07647 Tel. (201) 784-1000 Fax (201) 784-0111</p> | <p>Drawing Title: GTM96600-6019-T3, ICT / ITE / Medical Power Supply/Class 2/Household Power Supply, Efficiency Level: USA DOE Level VI / Eco-design Directive 2009/125/EC, (EU) 2019/1782, Case Color/Style: GlobTek Black, Desktop/External, Regulated Switchmode AC-DC Power Supply AC Adaptor, Input Rating: 100-240V~, 50-60Hz, IEC 60320/C14 , Output Rating: 60W, 19.0V@3.15A, Output Configuration: 1200 mm, 16 (Large ground 40/0.20) OD:4.3mm/1C + Shield Cond, UL 1185, Female Barrel 5.5*2.5*13mm, Right Angle High Retention Internal Spring Clip & Locking Notch, Ferrite: Core Size: 26 x 28.5 x 16, GlobTek Black, GT Cord # C51826, Pin Out: Center Positive (+V), symbol compliant with IEC 60417 symbol no. 5926, Blades/Input Cord: (Order Separately), Approvals: LPS 60950; India BIS; IP41; CB 60335; Fuse 60335; 230V CoC Tier 2; ETL; EAC; South Africa; UL 1310; cETLus 60950-1; cETLus 60601-1-11; CB 62368; UKCA; Conforms to 62368-1; NRCAN (5V only); Morocco; NOM (5V only); UL 1310; Korea (21.0V-28.0V Only); Singapore (19V); NOM (12V only); Malaysia; IRAM; Taiwan BSMI (24V only); 61558-1; IEC 61558-1; RCM; S-Mark 60950; IRAM; Ukraine; CB 60950; Class I; ETL 60950; CCC; CB 60601-1; S-Mark IEC/EN 60601-1; cETLus 60601-1; cULus (5V only); Taiwan BSMI (5V, 6.3V,12V only); Korea (6.3V Only); PSE; PSE; PSE; WEEE; V</p> |
| | <p>Model No. GTM96600-6019-T3</p> <p>Part No./Ordering No. TR9CZ3157LR13IMR6BF2Z</p> <p style="text-align: right;">Rev A1</p> |

- Several output connector options are available with various output current ratings. GlobTek can supply 10A rated 2.1mm and 2.5mm style DC Power Jacks, to complement our 10A output rated 2.1mm and 2.5mm DC power plugs used on our output cordsets.
- Please visit our real-time listing of mating connector product offering:
<https://en.globtek.com/news/high-current-coaxial-barrel-plug-jacks-for-high-wattage-power-supplies>

TO ADDRESS SYSTEM-LEVEL EMI CONCERNS, FERRITE CHOKES/BEADS MAY BE ADDED/REVISED UPON REQUEST. A SAMPLE KIT OF GLOBTEK'S STANDARD FERRITES IS AVAILABLE UNDER GLOBTEK P/N: EMI-MITIGATION-KIT1

FOR ADDITIONAL INFORMATION, PLEASE READ OUR WHITE PAPER AT: <https://r.globtek.info/3QeaqtD>

INGRESS PROTECTION: IP41

GlobTek, Inc.
 www.globtek.com
 186 Veterans Drive,
 Northvale, NJ 07647
 Tel. (201) 784-1000
 Fax (201) 784-0111

Drawing Title: GTM96600-6019-T3, ICT / ITE / Medical Power Supply/Class 2/Household Power Supply, Efficiency Level: USA DOE Level VI / Eco-design Directive 2009/125/EC, (EU) 2019/1782, Case Color/Style: GlobTek Black, Desktop/External, Regulated Switchmode AC-DC Power Supply AC Adaptor, Input Rating: 100-240V~, 50-60Hz, IEC 60320/C14 , Output Rating: 60W, 19.0V@3.15A, Output Configuration: 1200 mm, 16 (Large ground 40/0.20) OD:4.3mm/1C + Shield Cond, UL 1185, Female Barrel 5.5*2.5*13mm, Right Angle High Retention Internal Spring Clip & Locking Notch, Ferrite: Core Size: 26 x 28.5 x 16, GlobTek Black, GT Cord # C51826, Pin Out: Center Positive (+V), symbol compliant with IEC 60417 symbol no. 5926, Blades/Input Cord: (Order Separately), Approvals: LPS 60950; India BIS; IP41; CB 60335; Fuse 60335; 230V CoC Tier 2; ETL; EAC; South Africa; UL 1310; cETLus 60950-1; cETLus 60601-1-11; CB 62368; UKCA; Conforms to 62368-1; NRCAN (5V only); Morocco; NOM (5V only); UL 1310; Korea (21.0V-28.0V Only); Singapore (19V); NOM (12V only); Malaysia; IRAM; Taiwan BSMI (24V only); 61558-1; IEC 61558-1; RCM; S-Mark 60950; IRAM; Ukraine; CB 60950; Class I; ETL 60950; CCC; CB 60601-1; S-Mark IEC/EN 60601-1; cETLus 60601-1; cULus (5V only); Taiwan BSMI (5V, 6.3V,12V only); Korea (6.3V Only); PSE; PSE; PSE; WEEE; V

Model No. GTM96600-6019-T3

Part No./Ordering No. TR9CZ3157LR13IMR6BF2Z

Rev A1

3D File Download <https://www.globtek.com/dl/GTM96600-T3.igs>

Mechanical drawing

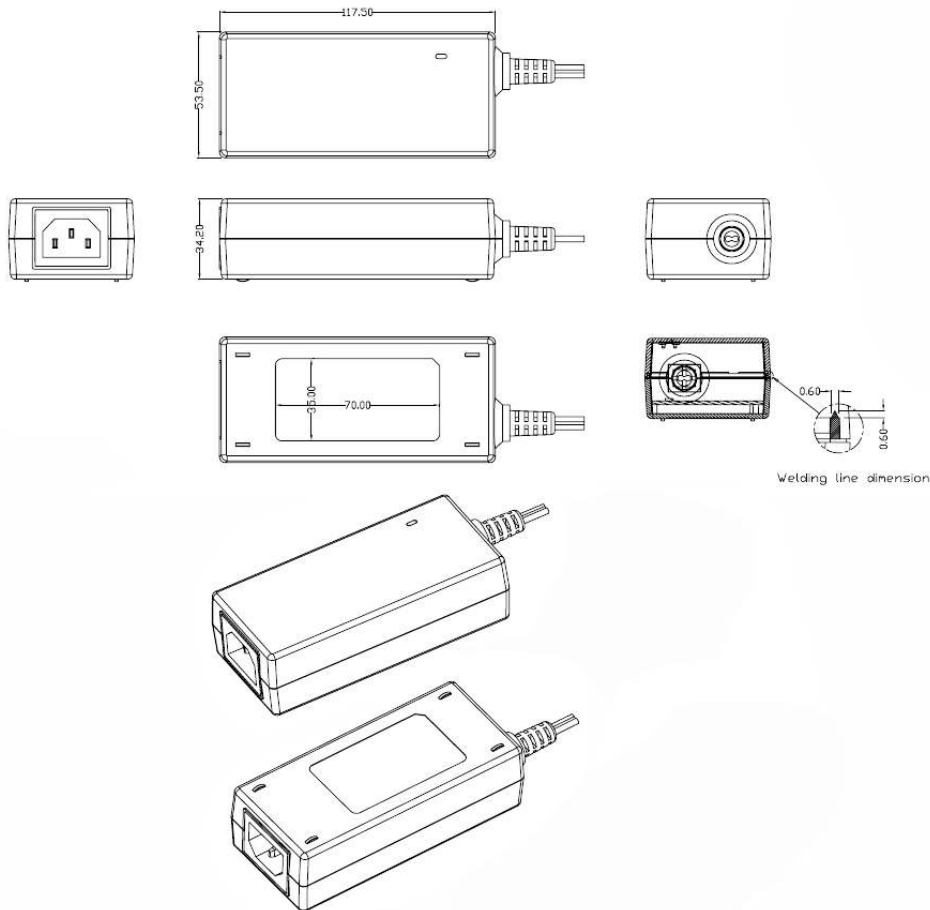

GlobTek, Inc.
 www.globtek.com
 186 Veterans Drive,
 Northvale, NJ 07647
 Tel. (201) 784-1000
 Fax (201) 784-0111

Drawing Title: GTM96600-6019-T3, ICT / ITE / Medical Power Supply/Class 2/Household Power Supply, Efficiency Level: USA DOE Level VI / Eco-design Directive 2009/125/EC, (EU) 2019/1782, Case Color/Style: GlobTek Black, Desktop/External, Regulated Switchmode AC-DC Power Supply AC Adaptor, Input Rating: 100-240V~, 50-60Hz, IEC 60320/C14 , Output Rating: 60W, 19.0V@3.15A, Output Configuration: 1200 mm, 16 (Large ground 40/0.20) OD:4.3mm/1C + Shield Cond, UL 1185, Female Barrel 5.5*2.5*13mm, Right Angle High Retention Internal Spring Clip & Locking Notch, Ferrite: Core Size: 26 x 28.5 x 16, GlobTek Black, GT Cord # C51826, Pin Out: Center Positive (+V), symbol compliant with IEC 60417 symbol no. 5926, Blades/Input Cord: (Order Separately), Approvals: LPS 60950; India BIS; IP41; CB 60335; Fuse 60335; 230V CoC Tier 2; ETL; EAC; South Africa; UL 1310; cETLus 60950-1; cETLus 60601-1-11; CB 62368; UKCA; Conforms to 62368-1; NRCAN (5V only); Morocco; NOM (5V only); UL 1310; Korea (21.0V-28.0V Only); Singapore (19V); NOM (12V only); Malaysia; IRAM; Taiwan BSMI (24V only); 61558-1; IEC 61558-1; RCM; S-Mark 60950; IRAM; Ukraine; CB 60950; Class I; ETL 60950; CCC; CB 60601-1; S-Mark IEC/EN 60601-1; cETLus 60601-1; cULus (5V only); Taiwan BSMI (5V, 6.3V,12V only); Korea (6.3V Only); PSE; PSE; PSE; WEEE; V

Model No. GTM96600-6019-T3

Part No./Ordering No. TR9CZ3157LR13IMR6BF2Z

Rev A1

DERATING CURVE

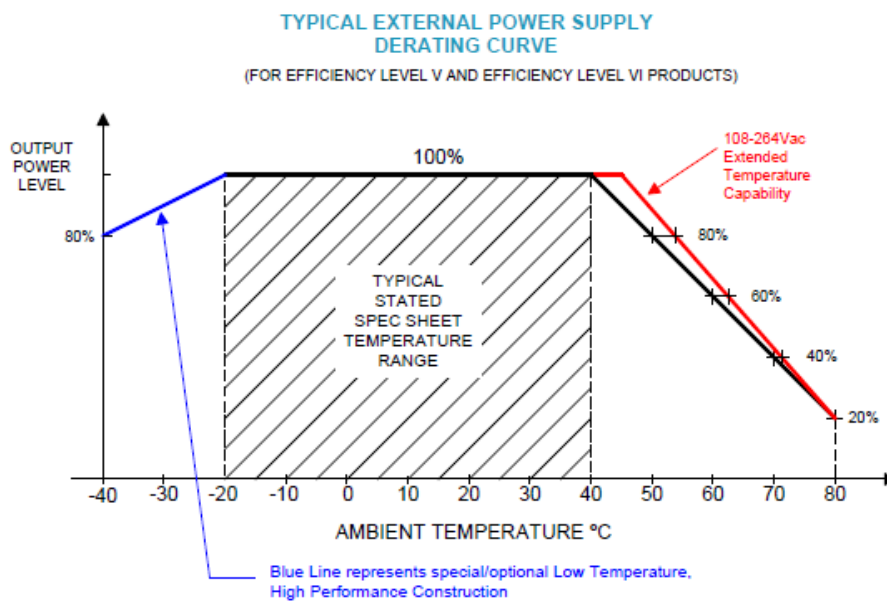

| | | |
|---|--|---------------|
| <p>GlobTek, Inc. www.globtek.com 186 Veterans Drive, Northvale, NJ 07647 Tel. (201) 784-1000 Fax (201) 784-0111</p> | <p>Drawing Title: GTM96600-6019-T3, ICT / ITE / Medical Power Supply/Class 2/Household Power Supply, Efficiency Level: USA DOE Level VI / Eco-design Directive 2009/125/EC, (EU) 2019/1782, Case Color/Style: GlobTek Black, Desktop/External, Regulated Switchmode AC-DC Power Supply AC Adaptor, Input Rating: 100-240V~, 50-60Hz, IEC 60320/C14 , Output Rating: 60W, 19.0V@3.15A, Output Configuration: 1200 mm, 16 (Large ground 40/0.20) OD:4.3mm/1C + Shield Cond, UL 1185, Female Barrel 5.5*2.5*13mm, Right Angle High Retention Internal Spring Clip & Locking Notch, Ferrite: Core Size: 26 x 28.5 x 16, GlobTek Black, GT Cord # C51826, Pin Out: Center Positive (+V), symbol compliant with IEC 60417 symbol no. 5926, Blades/Input Cord: (Order Separately), Approvals: LPS 60950; India BIS; IP41; CB 60335; Fuse 60335; 230V CoC Tier 2; ETL; EAC; South Africa; UL 1310; cETLus 60950-1; cETLus 60601-1-11; CB 62368; UKCA; Conforms to 62368-1; NRCAN (5V only); Morocco; NOM (5V only); UL 1310; Korea (21.0V-28.0V Only); Singapore (19V); NOM (12V only); Malaysia; IRAM; Taiwan BSMI (24V only); 61558-1; IEC 61558-1; RCM; S-Mark 60950; IRAM; Ukraine; CB 60950; Class I; ETL 60950; CCC; CB 60601-1; S-Mark IEC/EN 60601-1; cETLus 60601-1; cULus (5V only); Taiwan BSMI (5V, 6.3V,12V only); Korea (6.3V Only); PSE; PSE; PSE; WEEE; V</p> | |
| | <p>Model No. GTM96600-6019-T3</p> | |
| | <p>Part No./Ordering No. TR9CZ3157LR13IMR6BF2Z</p> | <p>Rev A1</p> |

INPUT CONFIGURATION

(F2) Isolated Functional Earth for GTM96 series, Improved EMC

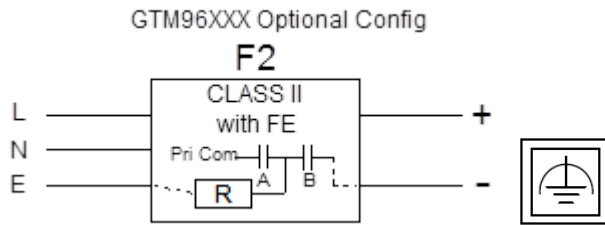

[Alternate grounding configurations](#) available upon request.

Blades/Cord Included:None:(Order Separately)

Blades/Cord Installed:None:(Order Separately)

IEC 60320/C14 AC Inlet Connector, Class I, Earth Ground

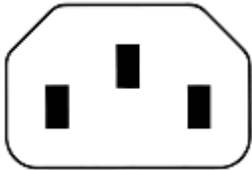

Mates with IEC 60320/C13 Plug

Optional Locking IEC60320 Receptacle and cord option available on some models by request.:



[Standard International IEC 320/C13 Cordsets](#)

Below are standard cordsets which are "not included" (unless stated above); these can be purchased separately or packaged with the power supply. Contact your Sales Engineer if the style required is not shown below. Many more available in different lengths, colors or cable material.

| | | |
|--|---|--------|
| GlobTek, Inc. www.globtek.com 186 Veterans Drive, Northvale, NJ 07647 Tel. (201) 784-1000 Fax (201) 784-0111 | Drawing Title: GTM96600-6019-T3, ICT / ITE / Medical Power Supply/Class 2/Household Power Supply, Efficiency Level: USA DOE Level VI / Eco-design Directive 2009/125/EC, (EU) 2019/1782, Case Color/Style: GlobTek Black, Desktop/External, Regulated Switchmode AC-DC Power Supply AC Adaptor, Input Rating: 100-240V~, 50-60Hz, IEC 60320/C14 , Output Rating: 60W, 19.0V@3.15A, Output Configuration: 1200 mm, 16 (Large ground 40/0.20) OD:4.3mm/1C + Shield Cond, UL 1185, Female Barrel 5.5*2.5*13mm, Right Angle High Retention Internal Spring Clip & Locking Notch, Ferrite: Core Size: 26 x 28.5 x 16, GlobTek Black, GT Cord # C51826, Pin Out: Center Positive (+V), symbol compliant with IEC 60417 symbol no. 5926, Blades/Input Cord: (Order Separately), Approvals: LPS 60950; India BIS; IP41; CB 60335; Fuse 60335; 230V CoC Tier 2; ETL; EAC; South Africa; UL 1310; cETLus 60950-1; cETLus 60601-1-11; CB 62368; UKCA; Conforms to 62368-1; NRCAN (5V only); Morocco; NOM (5V only); UL 1310; Korea (21.0V-28.0V Only); Singapore (19V); NOM (12V only); Malaysia; IRAM; Taiwan BSMI (24V only); 61558-1; IEC 61558-1; RCM; S-Mark 60950; IRAM; Ukraine; CB 60950; Class I; ETL 60950; CCC; CB 60601-1; S-Mark IEC/EN 60601-1; cETLus 60601-1; cULus (5V only); Taiwan BSMI (5V, 6.3V,12V only); Korea (6.3V Only); PSE; PSE; PSE; WEEE; V | |
| | Model No. GTM96600-6019-T3 | |
| | Part No./Ordering No. TR9CZ3157LR13IMR6BF2Z | Rev A1 |

Stock Power Supply Cords

| Part Number/ Link | Country | Plug | Termination | Length (mm) | (Ft) |
|--------------------------------------|--|---|-------------|-------------|------|
| 3021457F701(R) | N. American (Type B) | NEMA 5-15P | IEC 320/C13 | 2150 | 7 |
| 1191068F0701(R) | N. American (Type B) | NEMA 5-15P Hospital | IEC 320/C13 | 2459 | 8 |
| 2194272M5701-T(R) | Argentina (Type I) | IRAM 2073 | IEC 320/C13 | 2500 | 8 |
| 5502022M5701A(R) | Australian (Type I) | AS3112 / 3 PRONG | IEC 320/C13 | 2500 | 8 |
| 204B4272M5701(R) | Brazil (Type N) | BRAZIL | IEC 320/C13 | 2500 | 8 |
| 6023602M5701(R) | China (Type I) | CCC GR2099 | IEC 320/C13 | 2500 | 8 |
| G8014272M5701(R) | Danish (Type K) | AFSNIT SECTION 107-2-D1 | IEC 320/C13 | 2500 | 8 |
| 23144272M5701-T(R) | Europe (Type E) | CEE 7/7 | IEC 320/C13 | 2500 | 8 |
| 23134272M5701EUKR(R) | Europe/Korea Combo (Type E) | CEE 7/7 / KSC8305 | IEC 320/C13 | 2500 | 8 |
| 205IN4272M5701(R) | India (Type D) | India IS 1293 (also known as IA16A3 or BS546) | IEC 320/C13 | 2500 | 8 |
| 208IN4272M5701(R) | India (Type M) | India IS 1293 (also known as IA16A3 or BS546) | IEC320/C13 | 2500 | 8 |
| 377C4272M5701(R) | Israel (Type H) | ISL 377C | IEC 320/C13 | 2500 | 8 |
| 23024272M5701(R) | Italy (Type L) | CEI 23-16/VII | IEC 320/C13 | 2500 | 8 |
| 3003339F701(R) [3x1.25mm2] | Japan (Type B) | JIS 8303 / 3 PINS | IEC 320/C13 | 2500 | 8 |
| 3003068F2701-HK(R) [3 x 2.0mm2] | | | | | |
| 302J115J6F0701J(R) | North America / Japan (Type B – 12A) | NEMA 5-15P (cULus approved), Japan JIS C 8303 (PSE Approved) | IEC 320/C13 | 1830 | 6 |
| 302J104J6F0701J(R) | North America / Japan (Type B – 15A) | NEMA 5-15P (cULus approved), Japan JIS C 8303 (PSE Approved) | IEC 320/C13 | 1830 | 6 |
| 302JT104J9F0701JT(R) | North America / Japan / Taiwan (Type B – 15A) | NEMA 5-15P (cULus approved), Japan JIS C 8303 (PSE Approved), Taiwan CNS 6797 (BSMI Approved) | IEC 320/C13 | 2800 | 9 |
| 2313K3432M5701(R) | Korea (Type F) | KS C 8305 | IEC 320/C13 | 2500 | 8 |
| 5804272M5701(R) | Russia (Type F) | GOST 7396 | IEC 320/C13 | 2500 | 8 |
| 2084272M5701(R) | South Africa (Type M) | South Africa SABS164-1 (16A type) | IEC 320/C13 | 2500 | 8 |

PROPRIETARY INFORMATION

| | | |
|---|---|--------|
| GlobTek, Inc. www.globtek.com 186 Veterans Drive, Northvale, NJ 07647 Tel. (201) 784-1000 Fax (201) 784-0111 | Drawing Title: GTM96600-6019-T3, ICT / ITE / Medical Power Supply/Class 2/Household Power Supply, Efficiency Level: USA DOE Level VI / Eco-design Directive 2009/125/EC, (EU) 2019/1782, Case Color/Style: GlobTek Black, Desktop/External, Regulated Switchmode AC-DC Power Supply AC Adaptor, Input Rating: 100-240V~, 50-60Hz, IEC 60320/C14 , Output Rating: 60W, 19.0V@3.15A, Output Configuration: 1200 mm, 16 (Large ground 40/0.20) OD:4.3mm/1C + Shield Cond, UL 1185, Female Barrel 5.5*2.5*13mm, Right Angle High Retention Internal Spring Clip & Locking Notch, Ferrite: Core Size: 26 x 28.5 x 16, GlobTek Black, GT Cord # C51826, Pin Out: Center Positive (+V), symbol compliant with IEC 60417 symbol no. 5926, Blades/Input Cord: (Order Separately), Approvals: LPS 60950; India BIS; IP41; CB 60335; Fuse 60335; 230V CoC Tier 2; ETL; EAC; South Africa; UL 1310; cETLus 60950-1; cETLus 60601-1-11; CB 62368; UKCA; Conforms to 62368-1; NRCAN (5V only); Morocco; NOM (5V only); UL 1310; Korea (21.0V-28.0V Only); Singapore (19V); NOM (12V only); Malaysia; IRAM; Taiwan BSMI (24V only); 61558-1; IEC 61558-1; RCM; S-Mark 60950; IRAM; Ukraine; CB 60950; Class I; ETL 60950; CCC; CB 60601-1; S-Mark IEC/EN 60601-1; cETLus 60601-1; cULus (5V only); Taiwan BSMI (5V, 6.3V,12V only); Korea (6.3V Only); PSE; PSE; PSE; WEEE; V | |
| | Model No. GTM96600-6019-T3 | |
| | Part No./Ordering No. TR9CZ3157LR13IMR6BF2Z | Rev A1 |

| | | | | | |
|---------------------------------------|--|-----------------|-------------|------|---|
| 23214272M5701(R) | Switzerland (Type J) | SEV 1011 | IEC 320/C13 | 2500 | 8 |
| 3003322M5701(R) | Taiwan (Type B) | BSMI | IEC 320/C13 | 2500 | 8 |
| 6363762M5701(R) | Thailand (Type O) | TIS 166-2549 | IEC 320/C13 | 2500 | 8 |
| PZ0800100-2M5BK13H(R) | UK, Hong Kong, Singapore, Gulf States (Type G) | BS 1363A | IEC 320/C13 | 2500 | 8 |
| 7055002M5701A(R) | International | IEC 320 C14-C13 | IEC 320/C13 | 2500 | 8 |

| | | |
|---|---|--------|
| GlobTek, Inc. www.globtek.com 186 Veterans Drive, Northvale, NJ 07647 Tel. (201) 784-1000 Fax (201) 784-0111 | Drawing Title: GTM96600-6019-T3, ICT / ITE / Medical Power Supply/Class 2/Household Power Supply, Efficiency Level: USA DOE Level VI / Eco-design Directive 2009/125/EC, (EU) 2019/1782, Case Color/Style: GlobTek Black, Desktop/External, Regulated Switchmode AC-DC Power Supply AC Adaptor, Input Rating: 100-240V~, 50-60Hz, IEC 60320/C14 , Output Rating: 60W, 19.0V@3.15A, Output Configuration: 1200 mm, 16 (Large ground 40/0.20) OD:4.3mm/1C + Shield Cond, UL 1185, Female Barrel 5.5*2.5*13mm, Right Angle High Retention Internal Spring Clip & Locking Notch, Ferrite: Core Size: 26 x 28.5 x 16, GlobTek Black, GT Cord # C51826, Pin Out: Center Positive (+V), symbol compliant with IEC 60417 symbol no. 5926, Blades/Input Cord: (Order Separately), Approvals: LPS 60950; India BIS; IP41; CB 60335; Fuse 60335; 230V CoC Tier 2; ETL; EAC; South Africa; UL 1310; cETLus 60950-1; cETLus 60601-1-11; CB 62368; UKCA; Conforms to 62368-1; NRCAN (5V only); Morocco; NOM (5V only); UL 1310; Korea (21.0V-28.0V Only); Singapore (19V); NOM (12V only); Malaysia; IRAM; Taiwan BSMI (24V only); 61558-1; IEC 61558-1; RCM; S-Mark 60950; IRAM; Ukraine; CB 60950; Class I; ETL 60950; CCC; CB 60601-1; S-Mark IEC/EN 60601-1; cETLus 60601-1; cULus (5V only); Taiwan BSMI (5V, 6.3V,12V only); Korea (6.3V Only); PSE; PSE; PSE; WEEE; V | |
| | Model No. GTM96600-6019-T3 | |
| | Part No./Ordering No. TR9CZ3157LR13IMR6BF2Z | Rev A1 |

ADDITIONAL OUTPUT PLUG OPTIONS ARE AVAILABLE AT <https://www.globtek.com/connectors/>
 STANDARD PLUGS AND CONNECTORS CAN BE SEEN ONLINE AT <https://www.globtek.com/connectors/>
 CALCULATE VOLTAGE REGULATION/DROP WITH OUR ONLINE CALCULATOR: <https://en.globtek.com/output-cable-regulation-calculator/>

| | | |
|---|--|---------------|
| <p>GlobTek, Inc. www.globtek.com 186 Veterans Drive, Northvale, NJ 07647 Tel. (201) 784-1000 Fax (201) 784-0111</p> | <p>Drawing Title: GTM96600-6019-T3, ICT / ITE / Medical Power Supply/Class 2/Household Power Supply, Efficiency Level: USA DOE Level VI / Eco-design Directive 2009/125/EC, (EU) 2019/1782, Case Color/Style: GlobTek Black, Desktop/External, Regulated Switchmode AC-DC Power Supply AC Adaptor, Input Rating: 100-240V~, 50-60Hz, IEC 60320/C14 , Output Rating: 60W, 19.0V@3.15A, Output Configuration: 1200 mm, 16 (Large ground 40/0.20) OD:4.3mm/1C + Shield Cond, UL 1185, Female Barrel 5.5*2.5*13mm, Right Angle High Retention Internal Spring Clip & Locking Notch, Ferrite: Core Size: 26 x 28.5 x 16, GlobTek Black, GT Cord # C51826, Pin Out: Center Positive (+V), symbol compliant with IEC 60417 symbol no. 5926, Blades/Input Cord: (Order Separately), Approvals: LPS 60950; India BIS; IP41; CB 60335; Fuse 60335; 230V CoC Tier 2; ETL; EAC; South Africa; UL 1310; cETLus 60950-1; cETLus 60601-1-11; CB 62368; UKCA; Conforms to 62368-1; NRCAN (5V only); Morocco; NOM (5V only); UL 1310; Korea (21.0V-28.0V Only); Singapore (19V); NOM (12V only); Malaysia; IRAM; Taiwan BSMI (24V only); 61558-1; IEC 61558-1; RCM; S-Mark 60950; IRAM; Ukraine; CB 60950; Class I; ETL 60950; CCC; CB 60601-1; S-Mark IEC/EN 60601-1; cETLus 60601-1; cULus (5V only); Taiwan BSMI (5V, 6.3V,12V only); Korea (6.3V Only); PSE; PSE; PSE; WEEE; V</p> | |
| | <p>Model No. GTM96600-6019-T3</p> | |
| | <p>Part No./Ordering No. TR9CZ3157LR13IMR6BF2Z</p> | <p>Rev A1</p> |

OUTPUT CONNECTOR HOOK UP

TO ADDRESS SYSTEM-LEVEL EMI CONCERNS, FERRITE CHOKES/BEADS MAY BE ADDED/REVISED UPON REQUEST. A SAMPLE KIT OF GLOBTEK'S STANDARD FERRITES IS AVAILABLE UNDER GLOBTEK P/N: EMI-MITIGATION-KIT1

FOR ADDITIONAL INFORMATION, PLEASE READ OUR WHITE PAPER AT:

<https://en.globtek.com/technical-articles/ferrite-kit-radiated-emi-suppression-kit-for-globtek-power-supplies-cable-assemblies>

| | | |
|--|---|--------|
| GlobTek, Inc. www.globtek.com 186 Veterans Drive, Northvale, NJ 07647 Tel. (201) 784-1000 Fax (201) 784-0111 | Drawing Title: GTM96600-6019-T3, ICT / ITE / Medical Power Supply/Class 2/Household Power Supply, Efficiency Level: USA DOE Level VI / Eco-design Directive 2009/125/EC, (EU) 2019/1782, Case Color/Style: GlobTek Black, Desktop/External, Regulated Switchmode AC-DC Power Supply AC Adaptor, Input Rating: 100-240V~, 50-60Hz, IEC 60320/C14 , Output Rating: 60W, 19.0V@3.15A, Output Configuration: 1200 mm, 16 (Large ground 40/0.20) OD:4.3mm/1C + Shield Cond, UL 1185, Female Barrel 5.5*2.5*13mm, Right Angle High Retention Internal Spring Clip & Locking Notch, Ferrite: Core Size: 26 x 28.5 x 16, GlobTek Black, GT Cord # C51826, Pin Out: Center Positive (+V), symbol compliant with IEC 60417 symbol no. 5926, Blades/Input Cord: (Order Separately), Approvals: LPS 60950; India BIS; IP41; CB 60335; Fuse 60335; 230V CoC Tier 2; ETL; EAC; South Africa; UL 1310; cETLus 60950-1; cETLus 60601-1-11; CB 62368; UKCA; Conforms to 62368-1; NRCAN (5V only); Morocco; NOM (5V only); UL 1310; Korea (21.0V-28.0V Only); Singapore (19V); NOM (12V only); Malaysia; IRAM; Taiwan BSMI (24V only); 61558-1; IEC 61558-1; RCM; S-Mark 60950; IRAM; Ukraine; CB 60950; Class I; ETL 60950; CCC; CB 60601-1; S-Mark IEC/EN 60601-1; cETLus 60601-1; cULus (5V only); Taiwan BSMI (5V, 6.3V,12V only); Korea (6.3V Only); PSE; PSE; PSE; WEEE; V | |
| | Model No. GTM96600-6019-T3 | |
| | Part No./Ordering No. TR9CZ3157LR13IMR6BF2Z | Rev A1 |

LABEL:L-1622

| | |
|--------------------------------|--|
| LABEL P/N | ISO 15223 medical device compliant label - see deviations |
| MATERIAL | Flat Thermal Transfer, Imprintable, Polyester Label and/or Pad Printed and/or Molded, and/or Laser Engraved in the case |
| BACKGROUND COLOR | Black if housing is Black, White or Silver if housing is White or Gray. |
| TEXT COLOR | White or Silver if label is Black Background for Black housing. Black if label is White or Silver background and Housing is White or Gray. |
| LABEL WIDTH (mm) | 35.0 |
| LABEL HEIGHT (mm) | 70.0 |
| SPECIAL BARCODE LABEL MATERIAL | No |

Below is the minimum information which will appear on the label. NOTE: in the logo area additional/actual positioning of symbols and text is subjected to change as per agency updates/requirements or additional model approvals become available.

Agency logos may be in Regulatory Certifications/Label Markings area on the label or molded into the case housing outside the label area. Information will be shown via Label and/or Pad Printed and/or Molded in the case.



Please refer to the deviations section of the product specifications for additional details regarding the label.

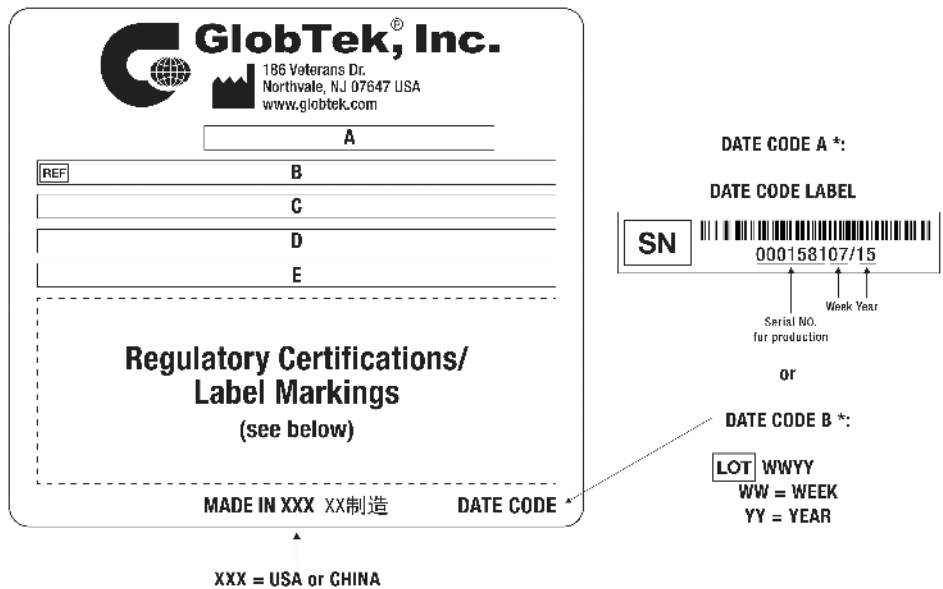

A=ICT / ITE / Medical Power Supply/Class 2/Household Power Supply

| | | |
|---|---|---------------|
| GlobTek, Inc. www.globtek.com 186 Veterans Drive, Northvale, NJ 07647 Tel. (201) 784-1000 Fax (201) 784-0111 | Drawing Title: GTM96600-6019-T3, ICT / ITE / Medical Power Supply/Class 2/Household Power Supply, Efficiency Level: USA DOE Level VI / Eco-design Directive 2009/125/EC, (EU) 2019/1782, Case Color/Style: GlobTek Black, Desktop/External, Regulated Switchmode AC-DC Power Supply AC Adaptor, Input Rating: 100-240V~, 50-60Hz, IEC 60320/C14 , Output Rating: 60W, 19.0V@3.15A, Output Configuration: 1200 mm, 16 (Large ground 40/0.20) OD:4.3mm/1C + Shield Cond, UL 1185, Female Barrel 5.5*2.5*13mm, Right Angle High Retention Internal Spring Clip & Locking Notch, Ferrite: Core Size: 26 x 28.5 x 16, GlobTek Black, GT Cord # C51826, Pin Out: Center Positive (+V), symbol compliant with IEC 60417 symbol no. 5926, Blades/Input Cord: (Order Separately), Approvals: LPS 60950; India BIS; IP41; CB 60335; Fuse 60335; 230V CoC Tier 2; ETL; EAC; South Africa; UL 1310; cETLus 60950-1; cETLus 60601-1-11; CB 62368; UKCA; Conforms to 62368-1; NRCAN (5V only); Morocco; NOM (5V only); UL 1310; Korea (21.0V-28.0V Only); Singapore (19V); NOM (12V only); Malaysia; IRAM; Taiwan BSMI (24V only); 61558-1; IEC 61558-1; RCM; S-Mark 60950; IRAM; Ukraine; CB 60950; Class I; ETL 60950; CCC; CB 60601-1; S-Mark IEC/EN 60601-1; cETLus 60601-1; cULus (5V only); Taiwan BSMI (5V, 6.3V,12V only); Korea (6.3V Only); PSE; PSE; PSE; WEEE; V | |
| | Model No. GTM96600-6019-T3 | |
| | Part No./Ordering No. TR9CZ3157LR13IMR6BF2Z | Rev A1 |

| |
|--|
| B=P/N: (料号) TR9CZ3157LR13IMR6BF2Z C=Model (型号) GTM96600-6019-T3 D=Input (输入)100-240V~, 50-60Hz, 1.5A E=Output (输出)19.0 V  3.15 A, 60.00W |
|--|

| | | |
|--|---|--------|
| GlobTek, Inc. www.globtek.com 186 Veterans Drive, Northvale, NJ 07647 Tel. (201) 784-1000 Fax (201) 784-0111 | Drawing Title: GTM96600-6019-T3, ICT / ITE / Medical Power Supply/Class 2/Household Power Supply, Efficiency Level: USA DOE Level VI / Eco-design Directive 2009/125/EC, (EU) 2019/1782, Case Color/Style: GlobTek Black, Desktop/External, Regulated Switchmode AC-DC Power Supply AC Adaptor, Input Rating: 100-240V~, 50-60Hz, IEC 60320/C14 , Output Rating: 60W, 19.0V@3.15A, Output Configuration: 1200 mm, 16 (Large ground 40/0.20) OD:4.3mm/1C + Shield Cond, UL 1185, Female Barrel 5.5*2.5*13mm, Right Angle High Retention Internal Spring Clip & Locking Notch, Ferrite: Core Size: 26 x 28.5 x 16, GlobTek Black, GT Cord # C51826, Pin Out: Center Positive (+V), symbol compliant with IEC 60417 symbol no. 5926, Blades/Input Cord: (Order Separately), Approvals: LPS 60950; India BIS; IP41; CB 60335; Fuse 60335; 230V CoC Tier 2; ETL; EAC; South Africa; UL 1310; cETLus 60950-1; cETLus 60601-1-11; CB 62368; UKCA; Conforms to 62368-1; NRCAN (5V only); Morocco; NOM (5V only); UL 1310; Korea (21.0V-28.0V Only); Singapore (19V); NOM (12V only); Malaysia; IRAM; Taiwan BSMI (24V only); 61558-1; IEC 61558-1; RCM; S-Mark 60950; IRAM; Ukraine; CB 60950; Class I; ETL 60950; CCC; CB 60601-1; S-Mark IEC/EN 60601-1; cETLus 60601-1; cULus (5V only); Taiwan BSMI (5V, 6.3V,12V only); Korea (6.3V Only); PSE; PSE; PSE; WEEE; V | |
| | Model No. GTM96600-6019-T3 | |
| | Part No./Ordering No. TR9CZ3157LR13IMR6BF2Z | Rev A1 |

| | |
|---|---|
| AGENCY ONLINE DOCUMENTS | http://www.globtek.info/certs/GTM96600-TZ/ |
| CE EC-Declaration for Medical | http://globtek.force.com/models/ec_declaration_product?id=01t3a000005LcTL&m=1 |
| CE EC-Declaration for Industrial/Commercial/ITE | http://globtek.force.com/models/ec_declaration_product?id=01t3a000005LcTL&i=2 |
| CE EC-Declaration for Household | http://globtek.force.com/models/ec_declaration_product?id=01t3a000005LcTL&h=2 |
| UKCA-Declaration for Medical | http://globtek.force.com/models/ukca_declaration_product?id=01t3a000005LcTL&m=1 |
| UKCA-Declaration for Industrial/Commercial/ITE | http://globtek.force.com/models/ukca_declaration_product?id=01t3a000005LcTL&i=2 |
| UKCA-Declaration for Household | http://globtek.force.com/models/ukca_declaration_product?id=01t3a000005LcTL&h=2 |
| Morocco SDoC Declaration | https://globtek.secure.force.com/models/Morocco_SDoC_Declaration?id=a0Oa000000MmCcmEAF |
| RoHS/RoHS3 Declaration | https://www.globtek.com/pdf/rohs_cert/01t3a000005LcTLAAW |
| REACH Declaration | https://www.globtek.com/pdf/iso_certificates/REACH.pdf |
| Conflict Minerals Declaration | https://www.globtek.com/pdf/conflict-minerals.pdf |
| Prop 65 Statement | https://en.globtek.com/prop-65-statement.pdf |

IPXY rating is based on 3rd party testing and customers should check suitability and test system level IPXY rating before ordering.

Regulatory Certifications/Label Markings

Below follows a link to the latest regulatory certifications and marks for this specific product. National standards as well as certification schemes are constantly changing and so is the set of certification marks and symbols applicable to this product. Various standards, marks and symbols, and certificates are subject to change at any time without notice.

Additional standards or unique country certifications are available upon request. Please contact Globtek to request a quotation.

LATEST PRODUCT/MODEL CERTIFICATIONS: <https://www.globtek.com/datasheet/w71084>

AGENCY ONLINE DOCUMENTS <http://www.globtek.info/certs/GTM96600-TZ/>



(F2) Isolated Functional Earth for GTM96 series, Improved EMC



Center Positive (+V), symbol compliant with IEC 60417 symbol no. 5926

| | | |
|--|---|--------|
| GlobTek, Inc. www.globtek.com 186 Veterans Drive, Northvale, NJ 07647 Tel. (201) 784-1000 Fax (201) 784-0111 | Drawing Title: GTM96600-6019-T3, ICT / ITE / Medical Power Supply/Class 2/Household Power Supply, Efficiency Level: USA DOE Level VI / Eco-design Directive 2009/125/EC, (EU) 2019/1782, Case Color/Style: GlobTek Black, Desktop/External, Regulated Switchmode AC-DC Power Supply AC Adaptor, Input Rating: 100-240V~, 50-60Hz, IEC 60320/C14 , Output Rating: 60W, 19.0V@3.15A, Output Configuration: 1200 mm, 16 (Large ground 40/0.20) OD:4.3mm/1C + Shield Cond, UL 1185, Female Barrel 5.5*2.5*13mm, Right Angle High Retention Internal Spring Clip & Locking Notch, Ferrite: Core Size: 26 x 28.5 x 16, GlobTek Black, GT Cord # C51826, Pin Out: Center Positive (+V), symbol compliant with IEC 60417 symbol no. 5926, Blades/Input Cord: (Order Separately), Approvals: LPS 60950; India BIS; IP41; CB 60335; Fuse 60335; 230V CoC Tier 2; ETL; EAC; South Africa; UL 1310; cETLus 60950-1; cETLus 60601-1-11; CB 62368; UKCA; Conforms to 62368-1; NRCAN (5V only); Morocco; NOM (5V only); UL 1310; Korea (21.0V-28.0V Only); Singapore (19V); NOM (12V only); Malaysia; IRAM; Taiwan BSMI (24V only); 61558-1; IEC 61558-1; RCM; S-Mark 60950; IRAM; Ukraine; CB 60950; Class I; ETL 60950; CCC; CB 60601-1; S-Mark IEC/EN 60601-1; cETLus 60601-1; cULus (5V only); Taiwan BSMI (5V, 6.3V,12V only); Korea (6.3V Only); PSE; PSE; PSE; WEEE; V | |
| | Model No. GTM96600-6019-T3 | |
| | Part No./Ordering No. TR9CZ3157LR13IMR6BF2Z | Rev A1 |

PACKAGING

| | |
|---------------------------------|---------------------------------|
| Packing Spec P/N | Standard DT, Cellular packaging |
| Box Qty | 20 |
| Gift Box Size (mm) | Cellular Packaging |
| Gift Box Color | None |
| Master Carton Size (mm) | 405 x 427 x 158 |
| Master Carton Cubic Volume (m³) | 0.03 |
| Master GW (Kg) | 8.2 kg |
| BLADES INCLUDED | None: (Order Separately) |
| BLADE/CORD INSTALLED | None: (Order Separately) |
| USER MANUAL* | |
| USER MANUAL WEB LINK | |

* This specification sheet is considered the user manual for all applications. It is expected that the buyer of this product will use it to formulate their own user manual for their end product and a user manual specifically for the power adapter is not usually required. If a user manual is not specifically listed above then none will be provided with this unit.

If specific packaging is required, this section must specify all requirements and note "no exceptions". If this section does not specify packaging, it is subject to change without notice at GlobTek's discretion.

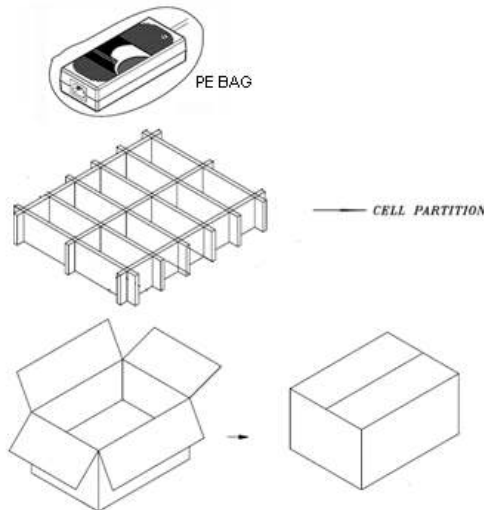

PROPRIETARY INFORMATION

PROPRIETARY OF GLOBTEK, INC. ANY REPRODUCTION, DISCLOSURE OR USE OF THIS DRAWING, IN WHOLE OR IN PART, IS HEREBY PROHIBITED EXCEPT AS SPECIFIED IN Page 19 of 21

WRITING BY GLOBTEK, INC. © GlobTek, Inc. 2022 - 2023

quest / 08/11/2023 7:34:25 PM GMT CLONED FROM TR9CZ3157LR13IMR6BF2Z

| | | |
|---|--|---------------|
| <p>GlobTek, Inc. www.globtek.com 186 Veterans Drive, Northvale, NJ 07647 Tel. (201) 784-1000 Fax (201) 784-0111</p> | <p>Drawing Title: GTM96600-6019-T3, ICT / ITE / Medical Power Supply/Class 2/Household Power Supply, Efficiency Level: USA DOE Level VI / Eco-design Directive 2009/125/EC, (EU) 2019/1782, Case Color/Style: GlobTek Black, Desktop/External, Regulated Switchmode AC-DC Power Supply AC Adaptor, Input Rating: 100-240V~, 50-60Hz, IEC 60320/C14 , Output Rating: 60W, 19.0V@3.15A, Output Configuration: 1200 mm, 16 (Large ground 40/0.20) OD:4.3mm/1C + Shield Cond, UL 1185, Female Barrel 5.5*2.5*13mm, Right Angle High Retention Internal Spring Clip & Locking Notch, Ferrite: Core Size: 26 x 28.5 x 16, GlobTek Black, GT Cord # C51826, Pin Out: Center Positive (+V), symbol compliant with IEC 60417 symbol no. 5926, Blades/Input Cord: (Order Separately), Approvals: LPS 60950; India BIS; IP41; CB 60335; Fuse 60335; 230V CoC Tier 2; ETL; EAC; South Africa; UL 1310; cETLus 60950-1; cETLus 60601-1-11; CB 62368; UKCA; Conforms to 62368-1; NRCAN (5V only); Morocco; NOM (5V only); UL 1310; Korea (21.0V-28.0V Only); Singapore (19V); NOM (12V only); Malaysia; IRAM; Taiwan BSMI (24V only); 61558-1; IEC 61558-1; RCM; S-Mark 60950; IRAM; Ukraine; CB 60950; Class I; ETL 60950; CCC; CB 60601-1; S-Mark IEC/EN 60601-1; cETLus 60601-1; cULus (5V only); Taiwan BSMI (5V, 6.3V,12V only); Korea (6.3V Only); PSE; PSE; PSE; WEEE; V</p> | |
| | <p>Model No. GTM96600-6019-T3</p> | |
| | <p>Part No./Ordering No. TR9CZ3157LR13IMR6BF2Z</p> | <p>Rev A1</p> |

INSTRUCTIONS TO THE OEM SYSTEMS ENGINEER

It is the responsibility of the OEM systems engineer to provide the end system user instructions and warnings for the use of this product in the end system.

If an input cord is required for this product, AC Mains voltage should be provided to the power supply by a power supply cord approved to the national standards of the country in which it will be used.

This product is not designed to be repaired. No serviceable parts inside. A blown internal fuse is an indication of catastrophic failure of circuit component(s). If a Failure Analysis is required for a failed power supply/battery charger, please return the damaged unit to GlobTek for an accurate determination of the root cause of the failure.

EMC Compliance of the complete OEM product, including the GlobTek power supply/battery charger needs to be verified by the OEM systems engineer.

INSTRUCTION SHEET

N/A

| | | |
|--|--|---------------|
| <p>GlobTek, Inc. www.globtek.com 186 Veterans Drive, Northvale, NJ 07647 Tel. (201) 784-1000 Fax (201) 784-0111</p> | <p>Drawing Title: GTM96600-6019-T3, ICT / ITE / Medical Power Supply/Class 2/Household Power Supply, Efficiency Level: USA DOE Level VI / Eco-design Directive 2009/125/EC, (EU) 2019/1782, Case Color/Style: GlobTek Black, Desktop/External, Regulated Switchmode AC-DC Power Supply AC Adaptor, Input Rating: 100-240V~, 50-60Hz, IEC 60320/C14 , Output Rating: 60W, 19.0V@3.15A, Output Configuration: 1200 mm, 16 (Large ground 40/0.20) OD:4.3mm/1C + Shield Cond, UL 1185, Female Barrel 5.5*2.5*13mm, Right Angle High Retention Internal Spring Clip & Locking Notch, Ferrite: Core Size: 26 x 28.5 x 16, GlobTek Black, GT Cord # C51826, Pin Out: Center Positive (+V), symbol compliant with IEC 60417 symbol no. 5926, Blades/Input Cord: (Order Separately), Approvals: LPS 60950; India BIS; IP41; CB 60335; Fuse 60335; 230V CoC Tier 2; ETL; EAC; South Africa; UL 1310; cETLus 60950-1; cETLus 60601-1-11; CB 62368; UKCA; Conforms to 62368-1; NRCAN (5V only); Morocco; NOM (5V only); UL 1310; Korea (21.0V-28.0V Only); Singapore (19V); NOM (12V only); Malaysia; IRAM; Taiwan BSMI (24V only); 61558-1; IEC 61558-1; RCM; S-Mark 60950; IRAM; Ukraine; CB 60950; Class I; ETL 60950; CCC; CB 60601-1; S-Mark IEC/EN 60601-1; cETLus 60601-1; cULus (5V only); Taiwan BSMI (5V, 6.3V,12V only); Korea (6.3V Only); PSE; PSE; PSE; WEEE; V</p> | |
| | <p>Model No. GTM96600-6019-T3</p> | |
| | <p>Part No./Ordering No. TR9CZ3157LR13IMR6BF2Z</p> | <p>Rev A1</p> |

