



Table of Contents

1 Introduction.....	2
2 Specifics Of The Board.....	2
3 Feature Options.....	2
4 Specification Summary.....	3
5 Performance Characteristics – Efficiency.....	3
6 Switch Node Voltage and Output Voltage Ripple.....	4
7 Load Transient Response.....	5
8 Bill of Materials.....	6
9 PCB Layout.....	8
10 Revision History.....	9

Trademarks

All trademarks are the property of their respective owners.

1 Introduction

This user's guide describes the LM2745 printed circuit board (PCB) design and provides an example typical application circuit. The LM2745 is a voltage mode PWM buck controller that implements synchronous rectification. It provides a low-cost, high power density, and efficient point of load solution. In steady state operation, the LM2745 is always synchronous, even at no load, simplifying the compensation design. The LM2745 ensures a smooth and controlled start-up when the output is pre-biased. The current limit protection does not require a current limit resistor in the power path, but is achieved by sensing the voltage V_{DS} across the low side MOSFET. Though the control sections of the IC are rated for 3 V to 6 V (V_{CC}), the driver sections are designed to accept input supply rails (V_{IN}) as high as 14 V.

2 Specifics Of The Board

This demo board targets the fixed and mobile telecommunications, industrial electronics, and distributed power markets. The demo board has a V_{IN} range of 8 V to 14 V and a LDO regulator, the LP2937, powers V_{CC} by regulating a 5-V output voltage. The LM2745 regulates to an output range of 1.2 V to 3.3 V at 19 A with a switching frequency of 300 kHz. The demo board is optimized for the previously mentioned parameters, thus for additional design modifications, refer to the *Design Consideration* section of the [LM2745/48 Synch Buck Controller w/ Pre-Bias Startup & Optional Clock Synchronization](#) data sheet. The PCB is designed on four layers. The top and bottom layers are 2-oz. copper and the two inner layers are 1-oz. copper. The board measures 2.19 inch × 1.03 inch × 0.41 inch (56 mm × 26.2 mm × 10.3 mm) (l × w × h) on a FR4 laminate.

3 Feature Options

When the tracking feature of the LM2745 is required for use, remove the jumper that connects the soft-start capacitor, C10, and connect the resistor divider, on designators R13 and R14 (see [Figure 3-1](#)). The Track terminal has been provided for the user's connecting convenience. The demo board is synchronize ready, just connect an external clock to the SYNC terminal.

Note

Increasing the switching frequency results in a lower inductor current ripple and input and output voltage ripple (if the component values are kept the same).

Monitor the MOSFET junction temperature since switching losses will increase, and do not exceed the maximum junction temperature of the MOSFET. Refer to the MOSFET manufacturer data sheet for the maximum junction temperature specification and heat sinking guidelines.

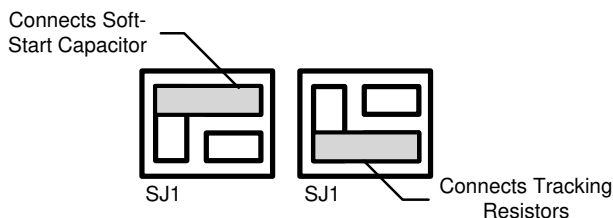

Figure 3-1. Soft-Start and Tracking Jumper

4 Specification Summary

- Space saving footprint
- Wide ambient temperature range: -40°C to 65°C
- Input voltage range: 8 V to 14 V
- Adjustable output voltage: 1.2 V to 3.3 V
- No minimum load requirement
- Remote ON/OFF
- Power-good signal
- Fixed switching frequency: 300 kHz
- Switching frequency synchronize range 250 kHz to 1 MHz
- Current limit protection
- Controller power supply start-up tracking function
- Start-up with a pre-biased output load
- Adjustable soft start
- Small size: 2.19 inch \times 1.03 inch \times 0.41 inch (56 mm \times 26.2 mm \times 10.3 mm)

5 Performance Characteristics – Efficiency

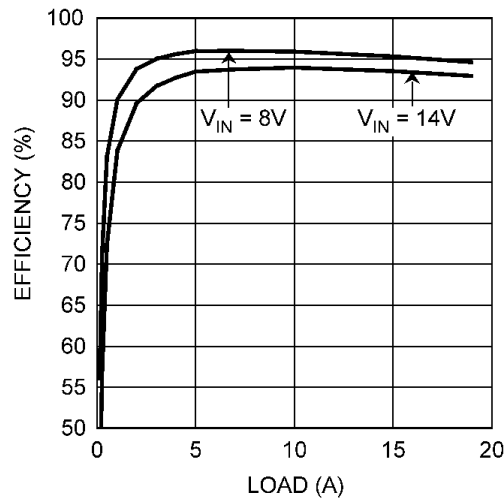

Figure 5-1. Efficiency vs. Load Current $V_{OUT} = 3.3\text{ V}$, $f_{SW} = 300\text{ kHz}$

6 Switch Node Voltage and Output Voltage Ripple

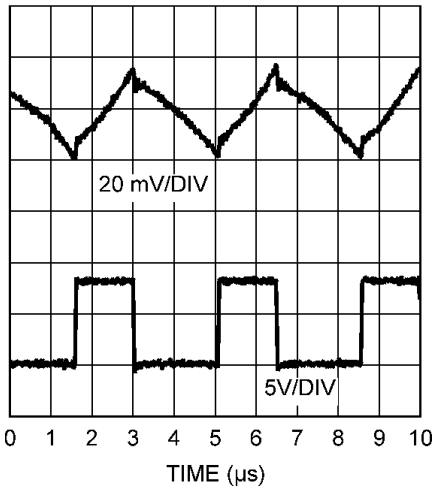

Figure 6-1. $V_{IN} = 8\text{ V}$, $V_{OUT} = 3.3\text{ V}$, $I_{LOAD} = 100\text{ mA}$, $f_{SW} = 300\text{ kHz}$, 20-MHz Bandwidth Limit

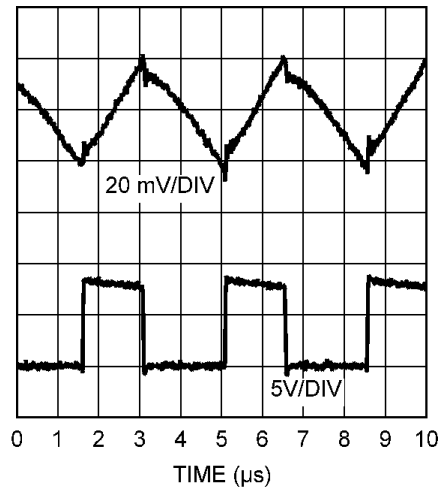

Figure 6-2. $V_{IN} = 8\text{ V}$, $V_{OUT} = 3.3\text{ V}$, $I_{LOAD} = 19\text{ A}$, $f_{SW} = 300\text{ kHz}$, 20-MHz Bandwidth Limit

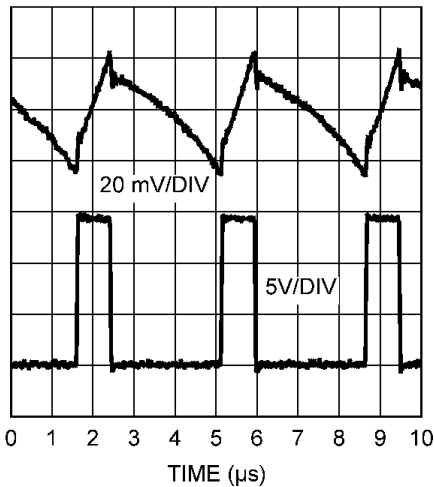

Figure 6-3. $V_{IN} = 14\text{ V}$, $V_{OUT} = 3.3\text{ V}$, $I_{LOAD} = 100\text{ mA}$, $f_{SW} = 300\text{ kHz}$, 20-MHz Bandwidth Limit

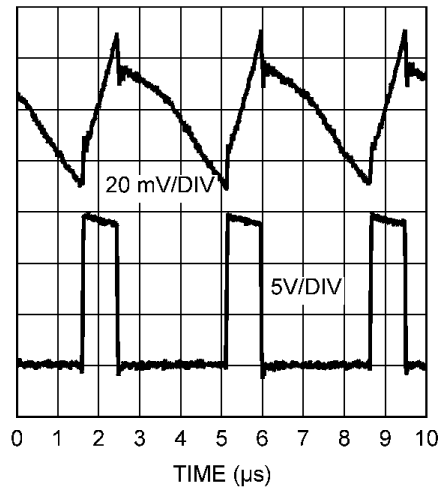

Figure 6-4. $V_{IN} = 14\text{ V}$, $V_{OUT} = 3.3\text{ V}$, $I_{LOAD} = 19\text{ A}$, $f_{SW} = 300\text{ kHz}$, 20-MHz Bandwidth Limit

7 Load Transient Response

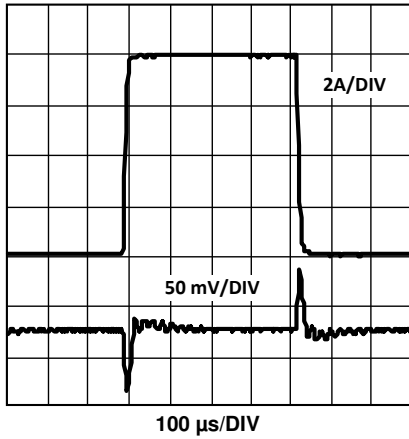

Figure 7-1. $V_{IN} = 14\text{ V}$, $V_{OUT} = 3.3\text{ V}$, $I_{LOAD} = 2\text{ A}$ to 10 A , CH1: V_{OUT} , CH2: I_{LOAD}

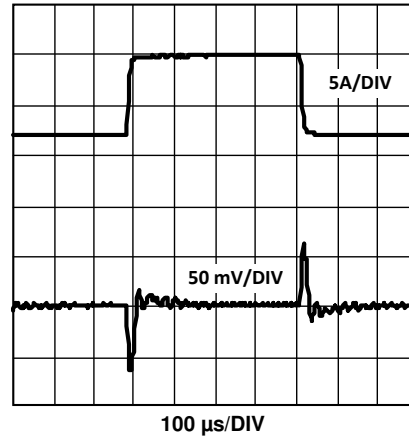

Figure 7-2. $V_{IN} = 14\text{ V}$, $V_{OUT} = 3.3\text{ V}$, $I_{LOAD} = 11\text{ A}$ to 19 A , CH1: V_{OUT} , CH2: I_{LOAD}

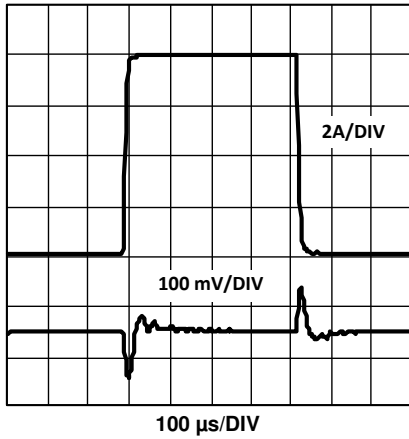

Figure 7-3. $V_{IN} = 8\text{ V}$, $V_{OUT} = 3.3\text{ V}$, $I_{LOAD} = 2\text{ A}$ to 10 A , CH1: V_{OUT} , CH2: I_{LOAD}

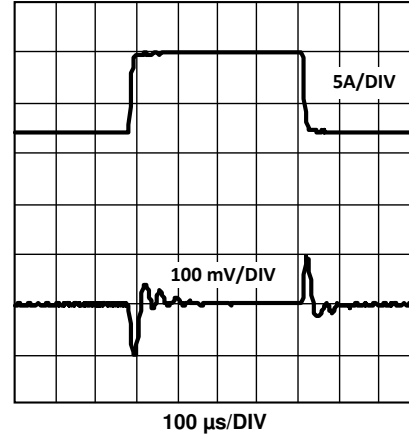

Figure 7-4. $V_{IN} = 8\text{ V}$, $V_{OUT} = 3.3\text{ V}$, $I_{LOAD} = 11\text{ A}$ to 19 A , CH1: V_{OUT} , CH2: I_{LOAD}

8 Bill of Materials

Table 8-1. Bill of Materials for LM2745 POL EVB (V_{IN} : 8 V to 14 V, V_{OUT} : 3.3 V, 19 A)

Location	Part Number	Type	Size	Parameters	Qty	Vendor
U1	LM2745	Syn. Buck Controller	TSSOP-14	V_{IN} : 4.5 V–5.5 V	1	NSC
U2	LM27937IMP-5.0	Linear Regulator 5 V,500 mA	SOT-223	5 V, 500 mA	1	NSC
L1	SER2010-202ML	Inductor		2 μ H, 27 A, 0.852 m Ω	1	Coilcraft
Q1-2	IRF6633	N-MOSFET	DirectFET-MP	20 V, 16 A, 4.1 m Ω , 11 nC	2	Vishay
Q3	IRF6609	N-MOSFET	DirectFET-MT	20 V, 150 A, 2 m Ω , 46 nC	1	Vishay
D1	SL22-E3/2C	Schottky Diode	SMB	20 V, 2 A	1	Vishay
D2	MBRS0520	Schottky Diode	SOD123	20 V, 0.5 A	1	Vishay
C1, 2	GRM32ER61C226KE20L	Ceramic Capacitor	1210	22 μ F, 25 V, X7R, 5%	2	Murata
C3, 11	GRM319R71H104KA01B	Ceramic Capacitor	1206	100 nF, 25 V, X7R, 10%	2	Murata
C14	GRM319R71H474KA01B	Ceramic Capacitor	1206	470 nF, 25 V, X7R, 10%	1	Murata
C9	GRM1885C1H1210JA01	Ceramic Capacitor	0603	120 pF, 50 V, C0G, 5%	1	Murata
C6	GRM188R71H222KA01	Ceramic Capacitor	0603	2.2 nF, 50 V, X7R, 10%	1	Murata
C7	GRM1885C1H101JA01	Ceramic Capacitor	0603	100 pF, 50 V, C0G, 5%	1	Murata
C8	GRM188R71H332KA01	Ceramic Capacitor	0603	3.3 nF, 50 V, X7R, 10%	1	Murata
C10	GRM188R71H153KA01	Ceramic Capacitor	0603	15 nF, 50 V, X7R, 10%	1	Murata
C12	GRM40X7R472K25	Ceramic Capacitor	0805	470 nF, 25 V, X7R, 10%	1	Murata
C13	12066D226MAT	Ceramic Capacitor	1206	22 μ F, 6.3 V, X5R, 20%	1	AVX
C4, 5	6SVPC220M	OS-CON	C6	220 μ F, 6.3 V, 20%	2	Sanyo
R1,18	CRCW06030R00F	Chip Resistor	0603	0 Ω	2	Vishay
R2	CRCW06032151F	Chip Resistor	0603	2.15 k, 1%	1	Vishay
R3, R17	CRCW06031002F	Chip Resistor	0603	10 k, 1%	2	Vishay
R4	CRCW06032211F	Chip Resistor	0603	2.21 k, 1%	1	Vishay
R10, 11	CRCW06031003F	Chip Resistor	0603	100 k, 1%	2	Vishay
R5, 6, 8	CRCW06032R21F	Chip Resistor	0603	2.21 Ω , 1%	3	Vishay
R7, 9	CRCW06034702F	Chip Resistor	0603	47 k, 1%	2	Vishay
R12	CRCW06038451F	Chip Resistor	0603	8.45 k, 1%	1	Vishay
R15	CRCW06031821F	Chip Resistor	0603	1.82 k, 1%	1	Vishay
R16	CRCW060310R0F	Chip Resistor	0603	10 Ω , 1%	1	Vishay
—	—	F-Pin			8	
—	—	Pin 90 deg., SIP, 6 way	Pitch: 2.54 mm		1	

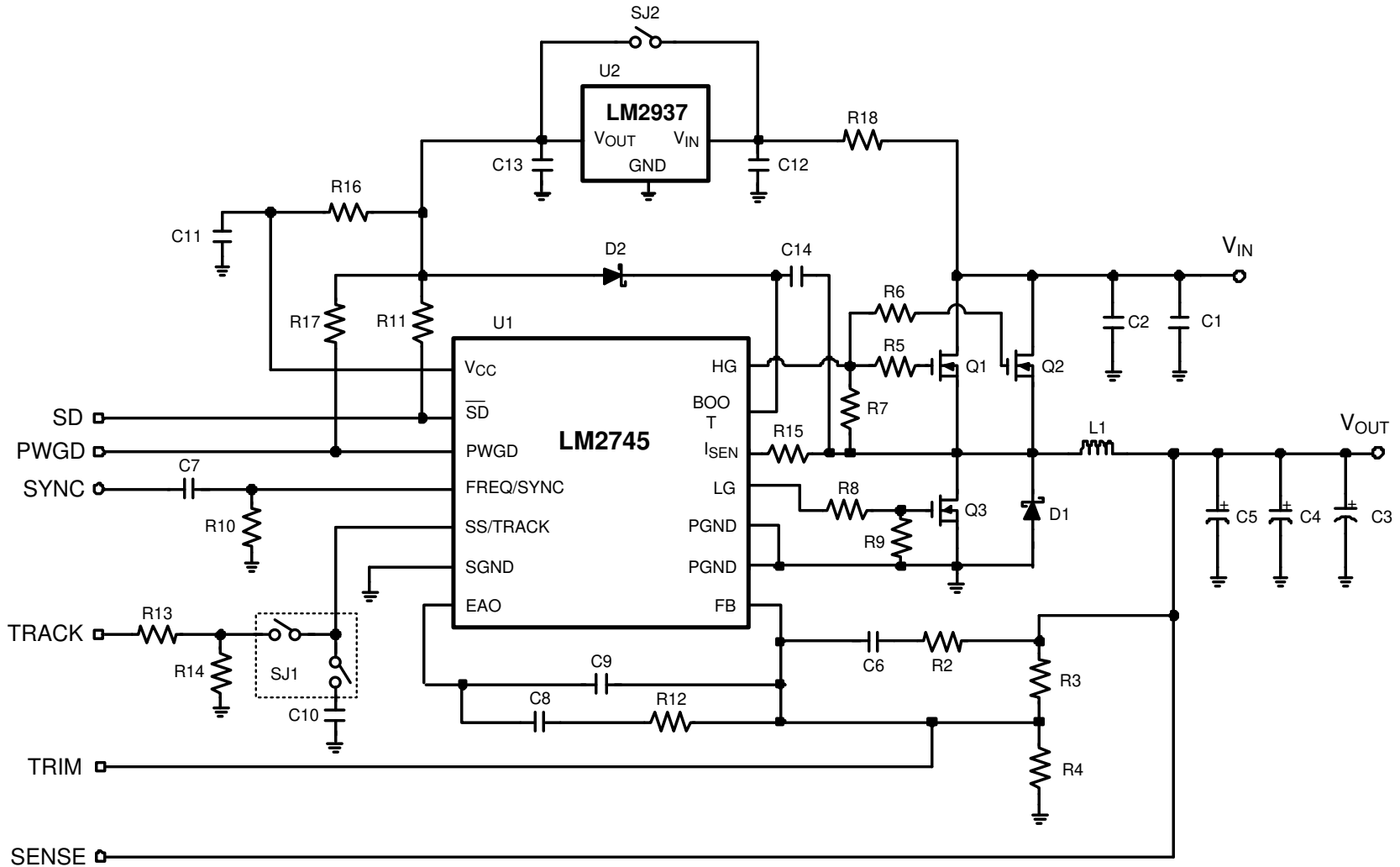

Figure 8-1. 300 kHz Demo Board Schematic

9 PCB Layout

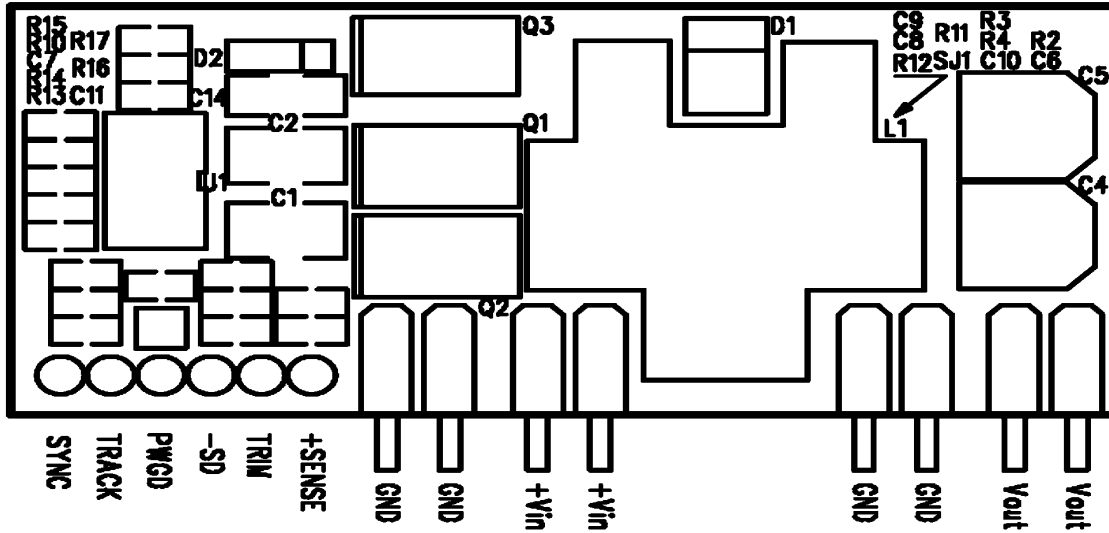

Figure 9-1. Top Silkscreen

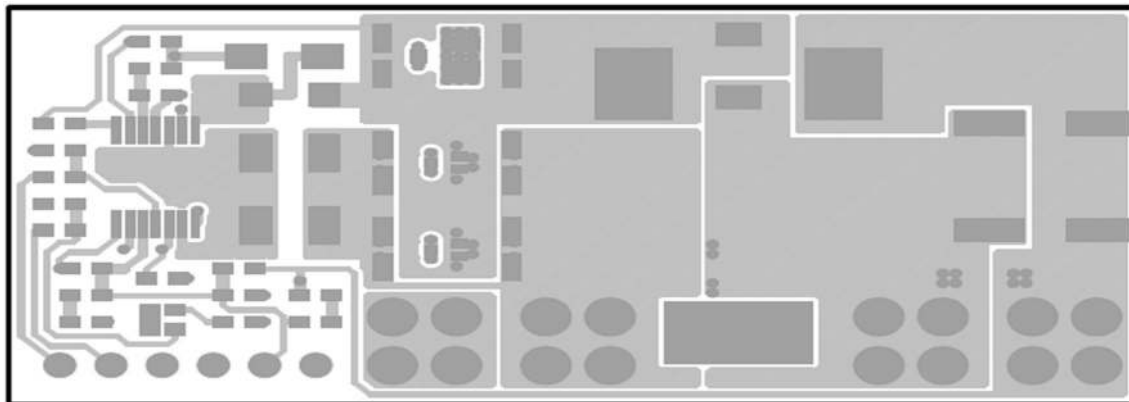

Figure 9-2. Top Copper Layer

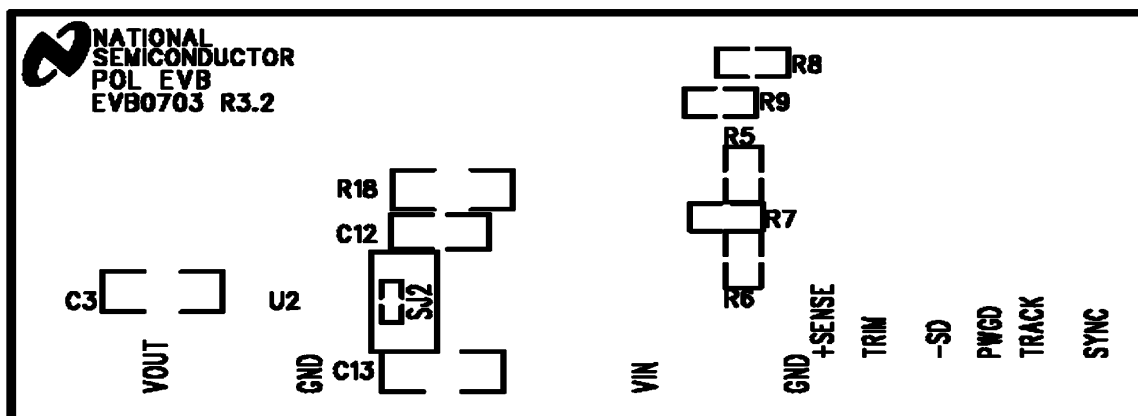

Figure 9-3. Bottom Silkscreen

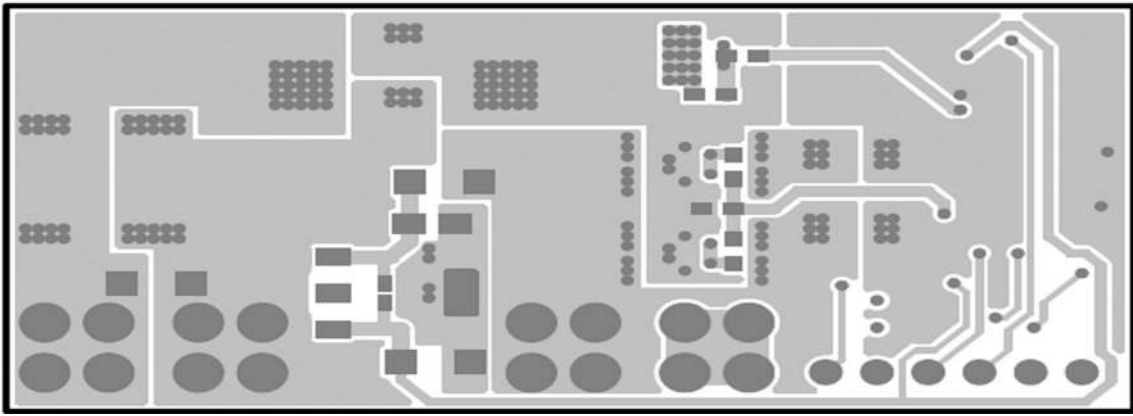

Figure 9-4. Bottom Copper Layer

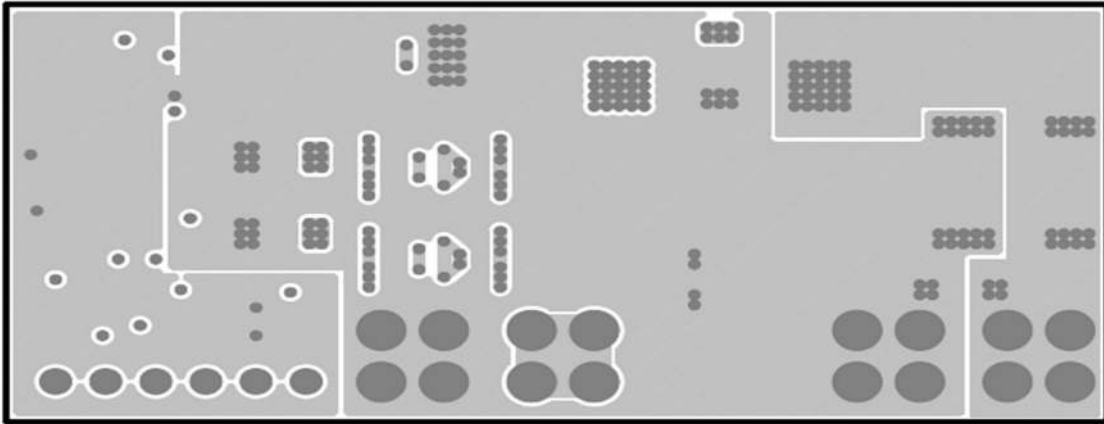

Figure 9-5. Internal Layer-1 (GND Copper)

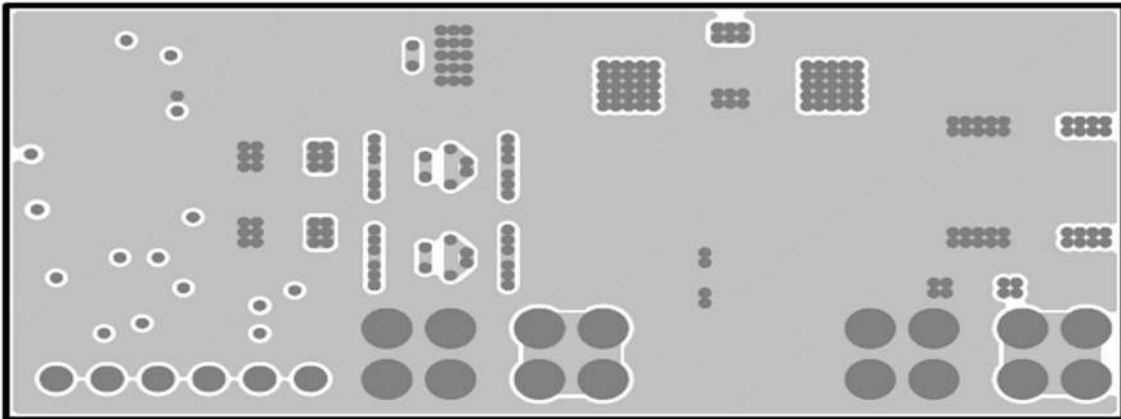

Figure 9-6. Internal Layer-2 (GND Copper)

10 Revision History

NOTE: Page numbers for previous revisions may differ from page numbers in the current version.

Changes from Revision A (May 2013) to Revision B (February 2022)	Page
• Updated the numbering format for tables, figures, and cross-references throughout the document.	2
• Updated the user's guide title.....	2

IMPORTANT NOTICE AND DISCLAIMER

TI PROVIDES TECHNICAL AND RELIABILITY DATA (INCLUDING DATA SHEETS), DESIGN RESOURCES (INCLUDING REFERENCE DESIGNS), APPLICATION OR OTHER DESIGN ADVICE, WEB TOOLS, SAFETY INFORMATION, AND OTHER RESOURCES "AS IS" AND WITH ALL FAULTS, AND DISCLAIMS ALL WARRANTIES, EXPRESS AND IMPLIED, INCLUDING WITHOUT LIMITATION ANY IMPLIED WARRANTIES OF MERCHANTABILITY, FITNESS FOR A PARTICULAR PURPOSE OR NON-INFRINGEMENT OF THIRD PARTY INTELLECTUAL PROPERTY RIGHTS.

These resources are intended for skilled developers designing with TI products. You are solely responsible for (1) selecting the appropriate TI products for your application, (2) designing, validating and testing your application, and (3) ensuring your application meets applicable standards, and any other safety, security, regulatory or other requirements.

These resources are subject to change without notice. TI grants you permission to use these resources only for development of an application that uses the TI products described in the resource. Other reproduction and display of these resources is prohibited. No license is granted to any other TI intellectual property right or to any third party intellectual property right. TI disclaims responsibility for, and you will fully indemnify TI and its representatives against, any claims, damages, costs, losses, and liabilities arising out of your use of these resources.

TI's products are provided subject to [TI's Terms of Sale](#) or other applicable terms available either on [ti.com](#) or provided in conjunction with such TI products. TI's provision of these resources does not expand or otherwise alter TI's applicable warranties or warranty disclaimers for TI products.

TI objects to and rejects any additional or different terms you may have proposed.

Mailing Address: Texas Instruments, Post Office Box 655303, Dallas, Texas 75265
Copyright © 2022, Texas Instruments Incorporated