

DESCRIPTION

MP2607 is a highly-integrated single-cell Li-Ion/Li-Polymer battery charger with system power path management function. It takes input from either AC adapter or USB port to supply the system and charge the battery independently. The charger section features trickle charge, high-accuracy constant current (CC) and constant voltage (CV) regulation, charge termination and charge status.

The system power path management function ensures continuous supply to the system by automatically selecting the input, the battery or both to power the system. This section features a low drop-out regulator from input to system, and a 50mΩ switch from battery to system. Power path management separates charging current from system load, which allows proper charge termination and keeps battery stay fully-charged. It also allows instantaneous power up of system with a deeply discharged battery.

MP2607 is available in 14pin 3mm*4mm QFN package.

FEATURES

- Fully Autonomous Charger for Single-Cell Li-Ion/Polymer Batteries
- Selectable Input Power Sources from AC Adapter or USB Port
- Built-in Current Limit for USB Port
- Complete Power Path Management for Simultaneously Powering the System and Charging the Battery
- 0.75% Charging Voltage Accuracy
- 12V Maximum Voltage for the Input Source
- Programmable Charging Current
- Built-in Timer for Charge Termination
- No External Blocking Diode Required
- Tiny QFN14 (3mm x 4mm) Package

APPLICATIONS

- Smart Handheld Devices
- Cell Phones, PDAs, MP3 Players
- Digital Cameras, GPS
- Handheld Test Equipment

All MPS parts are lead-free, halogen free, and adhere to the RoHS directive. For MPS green status, please visit MPS website under Quality Assurance.

"MPS" and "The Future of Analog IC Technology" are Registered Trademarks of Monolithic Power Systems, Inc.

TYPICAL APPLICATION

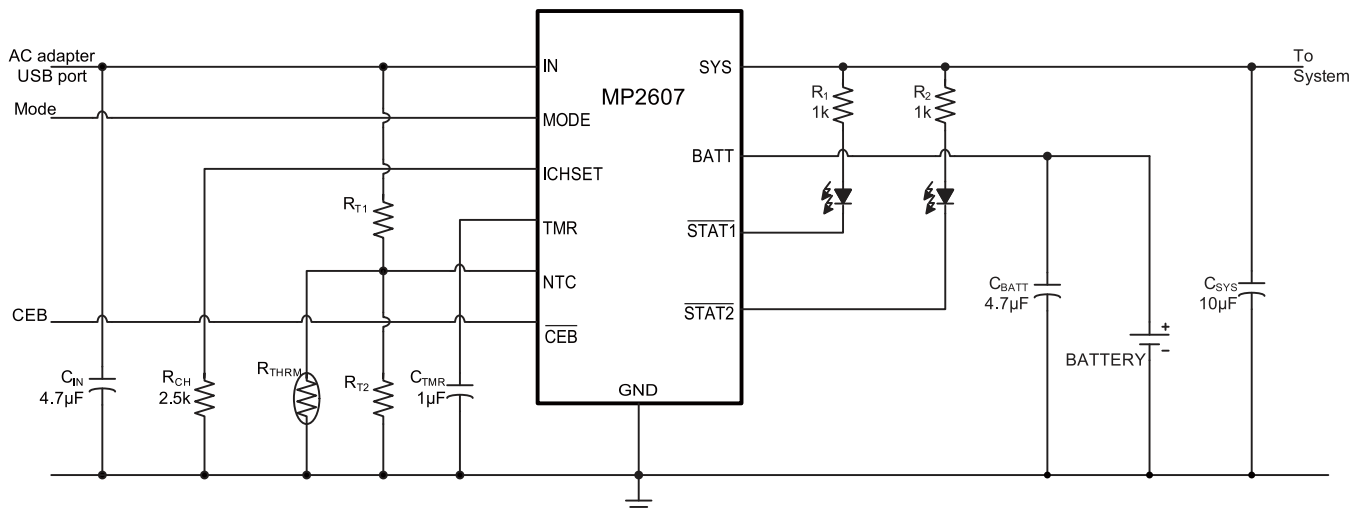

ORDERING INFORMATION

Part Number*	Package	Top Marking	Free Air Temperature (T _A)
MP2607DL	QFN-14 (3mm x 4mm)	2607	-40°C to +85°C

* For Tape & Reel, add suffix -Z (e.g. MP2607DL -Z);
 For RoHS compliant packaging, add suffix -LF; (e.g. MP2607DL -LF-Z)

PACKAGE REFERENCE

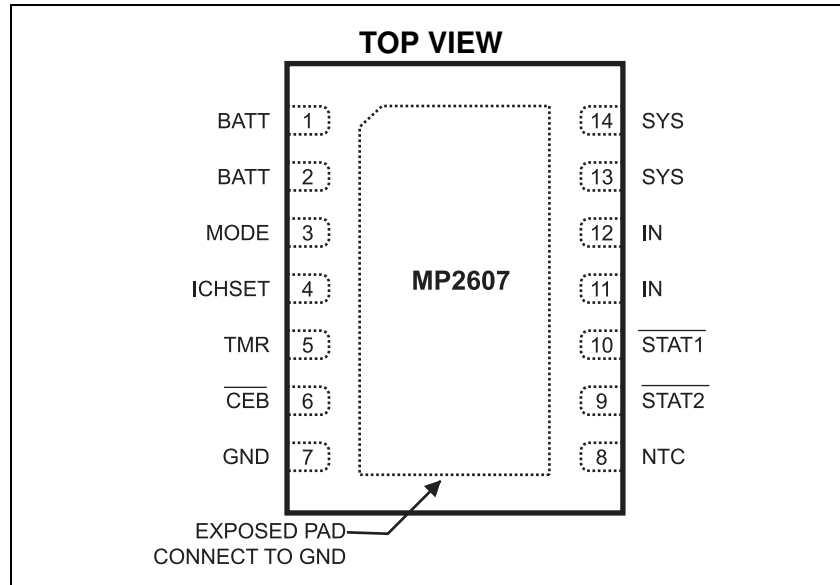

ABSOLUTE MAXIMUM RATINGS ⁽¹⁾

V _{IN}	-0.3V to 13V
V _{SYS} – V _{BATT}	-5V to 5V
All Other Pins.....	-0.3V to 6.5 V
Continuous Power Dissipation (T _A = +25°C) ⁽²⁾	3.1W
Junction Temperature	150°C
Lead Temperature	260°C
Storage Temperature.....	-65°C to 150°C

Recommended Operating Conditions ⁽³⁾

Supply Voltage V _{IN}	4.51V to 5.9V (AC Input) 4.51V to 6.27V (USB Input)
Output Voltage V _{BATT}	3.0V to 4.5V
Operating Junct. Temp (T _J).....	-40°C to +125°C

Thermal Resistance ⁽⁴⁾	θ_{JA}	θ_{JC}
QFN-14 (3mm x 4mm)	40	6
		°C/W

Notes:

- 1) Exceeding these ratings may damage the device.
- 2) The maximum allowable power dissipation is a function of the maximum junction temperature T_J(MAX), the junction-to-ambient thermal resistance θ_{JA}, and the ambient temperature T_A. The maximum allowable continuous power dissipation at any ambient temperature is calculated by P_D(MAX)=(T_J(MAX)-T_A)/ θ_{JA}. Exceeding the maximum allowable power dissipation will cause excessive die temperature, and the regulator will go into thermal shutdown. Internal thermal shutdown circuitry protects the device from permanent damage.
- 3) The device is not guaranteed to function outside of its operating conditions.
- 4) Measured on JESD51-7 4 layers board.

ELECTRICAL CHARACTERISTICS ⁽⁵⁾
 $V_{IN} = 5.5V$, $V_{BATT} = 3.5V$, $V_{CEB} = GND$, $T_A = 25^{\circ}C$, unless otherwise noted.

Parameter	Symbol	Condition	Min	Typ	Max	Units
IN Input Voltage	V_{IN}		4.51		12	V
IN Input Over Voltage Threshold	$V_{IN_OV_AC}$	MODE = 5V		5.9		V
	$V_{IN_OV_US}$	MODE = GND		6.27		
IN Input Over Voltage Hysteresis		AC mode, MODE = 5V		260		mV
		USB mode, MODE=GND		310		
Input Undervoltage Threshold	V_{IN_UV}	Input rising threshold	4.25	4.38	4.51	V
Input Undervoltage Threshold Hysteresis		AC mode, MODE = 5V		520		mV
		USB mode, MODE = GND		150		
Input vs. Battery Threshold	V_{IN_BAT}	Input rising vs. battery		120		mV
Input vs. Battery Threshold Hysteresis				70		mV
BATT Undervoltage Threshold	V_{UV_BAT}	BATT voltage rising	2.4	2.8	3.2	V
BATT Undervoltage Threshold Hysteresis				200		mV
Power Path Management						
AC Regulator Out Voltage	V_{AC_REG}	$V_{IN} = 5.5V$, MODE = 5V	4.65	4.85	5.05	V
AC Regulator Current Limit	I_{AC_MAX}	$V_{IN} = 5V$, MODE = 5V	1.4	2	2.6	A
USB input current limit	I_{USB_MAX}	MODE = GND, $V_{IN} = 5V$, $V_{BATT}=4V$	410	450	490	mA
Input selection threshold	V_{MODE}	MODE > V_{MODE} , AC adapter	1.5			V
		MODE < V_{MODE} , USB port			0.3	V
SYS Output Voltage	V_{SYS}	$V_{IN} = 5.5V$ MODE = 5V	$I_{SYS}+I_{CHG} <$ adapter current limit, $I_{SYS}=100mA$		4.85	V
			$I_{SYS}+I_{CHG} >$ adapter current limit, $I_{SYS}=400mA$		4.2	
		$V_{IN} = 5V$, MODE=GND	$I_{SYS}+I_{CHG} <$ USB port current limit, $I_{SYS}=100mA$		4.93	
			$I_{SYS} >$ USB port current limit, $V_{BATT}=3.5V$		3.4	
		$V_{IN} = 3.5V$, $V_{BATT}=3.2V$ (V_{BATT} Rising edge)			3.2	
IN to SYS Switch On Resistance	R_{ON_SYS}	$I_{SYS}(400mA)+I_{CHG} > I_{Adapter}$, MODE = 5V		300	450	m Ω

ELECTRICAL CHARACTERISTICS ⁽⁵⁾ (continued)
 $V_{IN} = 5.5V, V_{BATT} = 3.5V, V_{CEB} = GND, T_A = 25^\circ C$, unless otherwise noted.

Parameter	Symbol	Condition	Min	Typ	Max	Units
Supply Current at Input	I_{IN}	$\overline{CEB} = GND, I_{CHG} = 0A, I_{SYS} = 0A, V_{BATT}=4.5V, V_{IN} = 5.5V, MODE = 5V$		420		μA
		$\overline{CEB} = GND, I_{CHG} = 0A, I_{SYS} = 0A, V_{BATT}=4.5V, V_{IN} = 5.5V, MODE = GND$		400		
		$\overline{CEB} = 5V, I_{CHG} = 0A, I_{SYS} = 0A, V_{BATT}=4.5V, V_{IN} = 5.5V$		120		μA
		$\overline{CEB} = 5V, I_{CHG} = 0A, I_{SYS} = 0A, V_{BATT}=4.5V, V_{IN} = 12V$		1.4		mA
Supply Current at BATT Input	I_{BATT}	$\overline{CEB} = GND, V_{IN}=5.5V, V_{BATT}=4.5V, I_{SYS}=0A$		125		μA
		$\overline{CEB} = GND, V_{IN} = 4V, V_{BATT}=4.5V, I_{SYS}=0A$		25	35	
		$\overline{CEB} = 5V, I_{SYS} = 0A, V_{BATT}=3.5V$		20	30	
BATT Input to SYS Switch On Resistance	R_{ON_BSW}	$V_{IN}=GND, V_{BATT}=3.5V, I_{SYS}=100mA$		50	80	m Ω
BATT Input to SYS Switch On Voltage Drop	V_{D_BSW}	$V_{BATT}=3.5V, I_{SYS} =600mA, V_{IN} =5V$ (Battery supplement mode), $\overline{CEB} = GND, MODE = GND$	40	100	160	mV
BATT to SYS Short Protection Current	I_{BATT_MAX}	$V_{BATT}=3.5V, V_{SYS}=GND, \overline{CEB} =5V$ (guaranteed by design)		300		mA
BATT to SYS Switch Leakage		$V_{BATT}=2.3V, V_{IN}=V_{SYS}=GND, \overline{CEB} =5V$			1	μA
SYS Reverse to BATT Switch Leakage		$V_{SYS}=5V, V_{IN}=V_{BATT}=GND, \overline{CEB} =5V$			1	μA
Charger						
Battery Voltage Regulation	V_{BATT}	$T = +25^\circ C, I_{BATT} = 0$	4.179	4.20	4.221	V
		$T = 0^\circ C$ to $+50^\circ C, I_{BATT} = 0$	4.168	4.20	4.232	
		$T = -5^\circ C$ to $+75^\circ C, I_{BATT} = 0$	4.158	4.20	4.242	
IN to BATT Switch On Resistance	R_{ON_BATT}	$V_{IN}=4.3V, V_{BATT}=4.165V, I_{CHG}=1A$		200	400	m Ω
Constant Current Regulation for Charging	I_{CHG}	$V_{IN} = 5V, V_{BATT} = 3.5V, MODE = 5V, R_{CHG} = 2.263k\Omega$	880	1000	1120	mA
		$V_{IN} = 5V, V_{BATT} = 3.5V, MODE = GND, R_{CHG} = 7.6k\Omega$	210	300	390	mA
Programmable Charge Current	I_{CHG}	$V_{IN} = 5V, V_{BATT} = 3.5V, MODE = 5V$			1.5 ⁽⁵⁾	A

ELECTRICAL CHARACTERISTICS ⁽⁵⁾ (continued)
 $V_{IN} = 5.5V$, $V_{BATT} = 3.5V$, $V_{CEB} = GND$, $T_A = 25^{\circ}C$, unless otherwise noted.

Parameter	Symbol	Condition	Min	Typ	Max	Units
Charging current Thermal Fold-back Threshold			105	120	135	$^{\circ}C$
Constant Current Variation for Charging	ΔI_{CHG}	$V_{SYS} = 5V$, $V_{BATT} = 3.5V$ $1.5k\Omega < R_{CHG} < 7.6k\Omega$	-12		12	% I_{CHG}
		$7.6k\Omega < R_{CHG} < 22k\Omega$	-30		30	
Trickle Charge Current ⁽⁷⁾	I_{TRKL}	$V_{BATT} = 2.0V$, $R_{CHG} = 2.263k\Omega$	5	8.5	12	% I_{CHG}
End of Charge (EOC) current threshold ⁽⁸⁾	I_{EOC}	$R_{CHG} = 2.263k\Omega$ (1A I_{CHG})	7	10	13	% I_{CHG}
		$R_{CHG} = 22.6k\Omega$ (100mA I_{chg})	9	15	25	mA
Voltage at ICHSET pin	V_{ICHSET}	$1.5k\Omega < R_{CHG} < 4.5k\Omega$	$\frac{R_{CHG} * I_C}{HG/2016}$	$\frac{R_{CHG} * I_C}{HG/1800}$	$\frac{R_{CHG} * I_C}{HG/1584}$	V
Trickle Threshold Voltage	V_{TH_TRKL}	V_{BATT} Rising	2.7	2.8	2.9	V
Trickle Voltage Hysteresis				190		mV
Auto Re-charge Fall Threshold	V_{RECHG}	V_{BATT} Falling	3.95	4.05	4.15	V
\overline{CEB} Threshold		Logic Low			0.3	V
\overline{CEB} Threshold		Logic High	2			V
\overline{CEB} pin Pull-up Resistor				1		M Ω
STAT1, STAT2 Sink Current		Pin Voltage = 0.3V	8			mA
Battery Reverse Current to IN pin		IN pin grounded, $V_{BATT} = 4.3V$			1	μA
Timer for Charging	τ_{TMR_F}	$C_{TMR} = 1\mu F$, $R_{CHG} = 2.263k\Omega$ (1A I_{CHG})		1.1		Hour
		$C_{TMR} = 1\mu F$, $R_{CHG} = 22.6k\Omega$ (100mA I_{CHG})		8.4		Hour
Timer Count	C_{TMR_F}			2^{17}		
	C_{TMR_T}			2^{15}		
Timer Accuracy		$R_{CHG} = 2.263k\Omega$ (1A I_{CHG})	-20		20	%
		$R_{CHG} = 22.6k\Omega$ (100mA I_{CHG})	-40		40	%
NTC pin Output Current	I_{NTC}	$\overline{CEB} = GND$	-100	0	100	nA
Temperature Fault Threshold Voltage	V_{TH_LT}	Ambient Temp = $0^{\circ}C$	58	60	62	% V_{IN}
	V_{TH_HT}	Ambient Temp = $50^{\circ}C$	28	30	32	% V_{IN}

Notes:

- 5) Min. V_{IN} is determined by internal UVLO and relative to BATT voltage
- 6) High Charge current make MP2607 get into thermal fold-back and charge current will drop down.
- 7) I_{CHG} is the target preprogrammed charge current (Die temperature below $110^{\circ}C$), i.e. typical value of I_{CHG} .
- 8) I_{EOC} is the target preprogrammed battery full current threshold, i.e. typical value of I_{EOC} .

PIN FUNCTIONS

Pin #	Name	I/O	Description
1, 2	BATT	I/O	Connected to battery
3	MODE	I	Input select for AC adapter or USB port
4	ICHSET	O	Connected to an external resistor to set charging current ICHG
5	TMR	I	Program pin to set timer for the charger with an external capacitor; 470nF equivalent to 1 hour if R _{CHG} is 4.2kΩ
6	$\overline{\text{CEB}}$	I	Enable pin for MP2607. $\overline{\text{CEB}}$ high (>2V) disables IN (AC or USB) regulation path and charger, the system is supplied only from battery
7	GND	Power	Ground
8	NTC	O	Battery temperature sense pin, connected to the thermistor of battery pack
9	$\overline{\text{STAT2}}$	O	Charging status indication pin: 1. charging; 2. end of charge; 3. charge suspend; 4. Fault
10	$\overline{\text{STAT1}}$	O	
11, 12	IN	Power	Input for AC adapter or USB port
13, 14	SYS	Power	System power supply.

TYPICAL PERFORMANCE CURVES

$V_{IN}=5.5V$, $C_{IN}=4.7\mu F$, $C_{SYS}=10\mu F$, $C_{BAT}=4.7\mu F$, $T_A=25^\circ C$, unless otherwise noted.

Battery Charge Curve

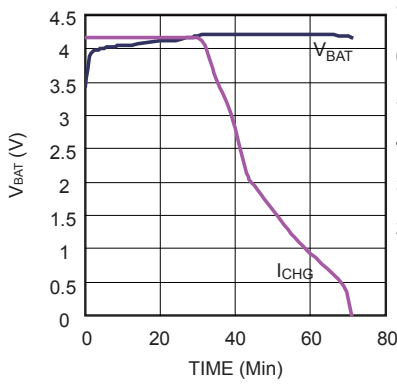

Charge Current vs. Battery Voltage

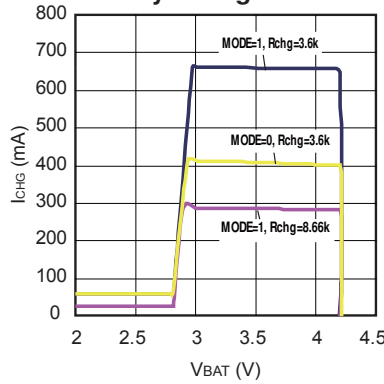

I_{CHG} vs. $1/R_{CHG}$

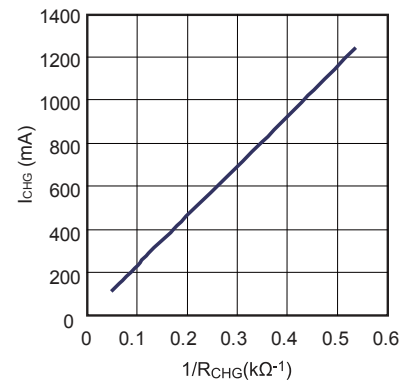

CC Charge Current vs. Input Voltage

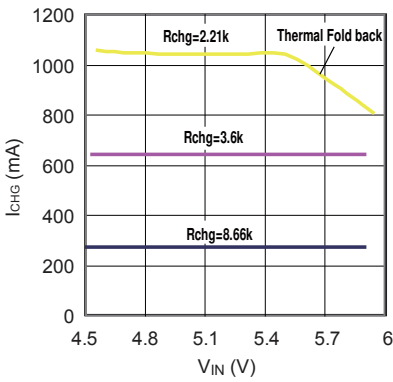

CC Charge Current vs. Temperature

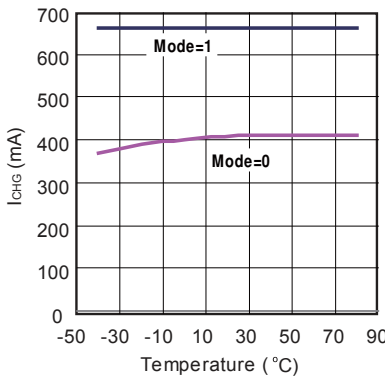

V_{BAT} CV Regulation Voltage vs. Temperature

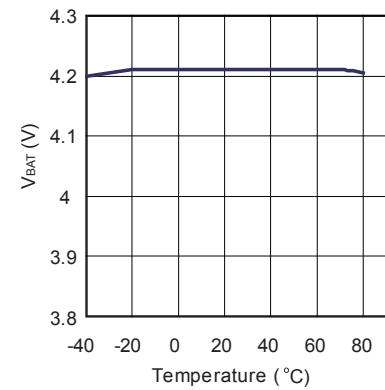

Power Path Management

MODE=1, 1.5A Source Current Limit, W/ Battery

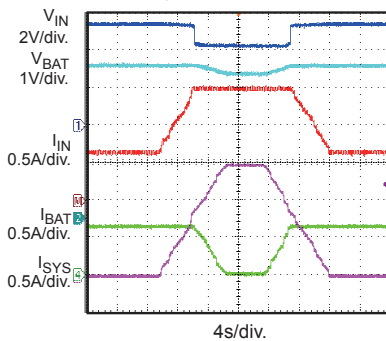

Power Path Management

MODE=0, W/ Battery

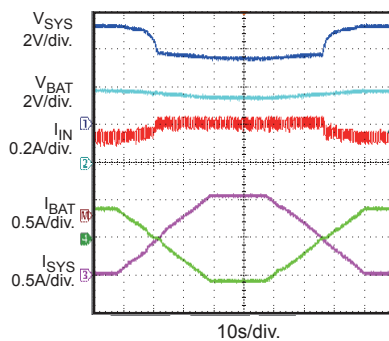

Power Path Management

MODE=0, W/ Battery

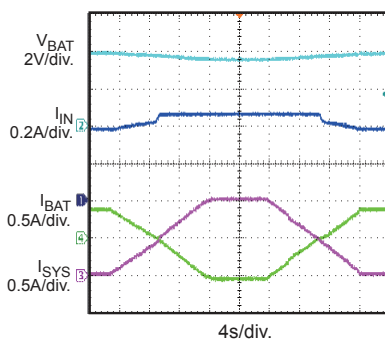

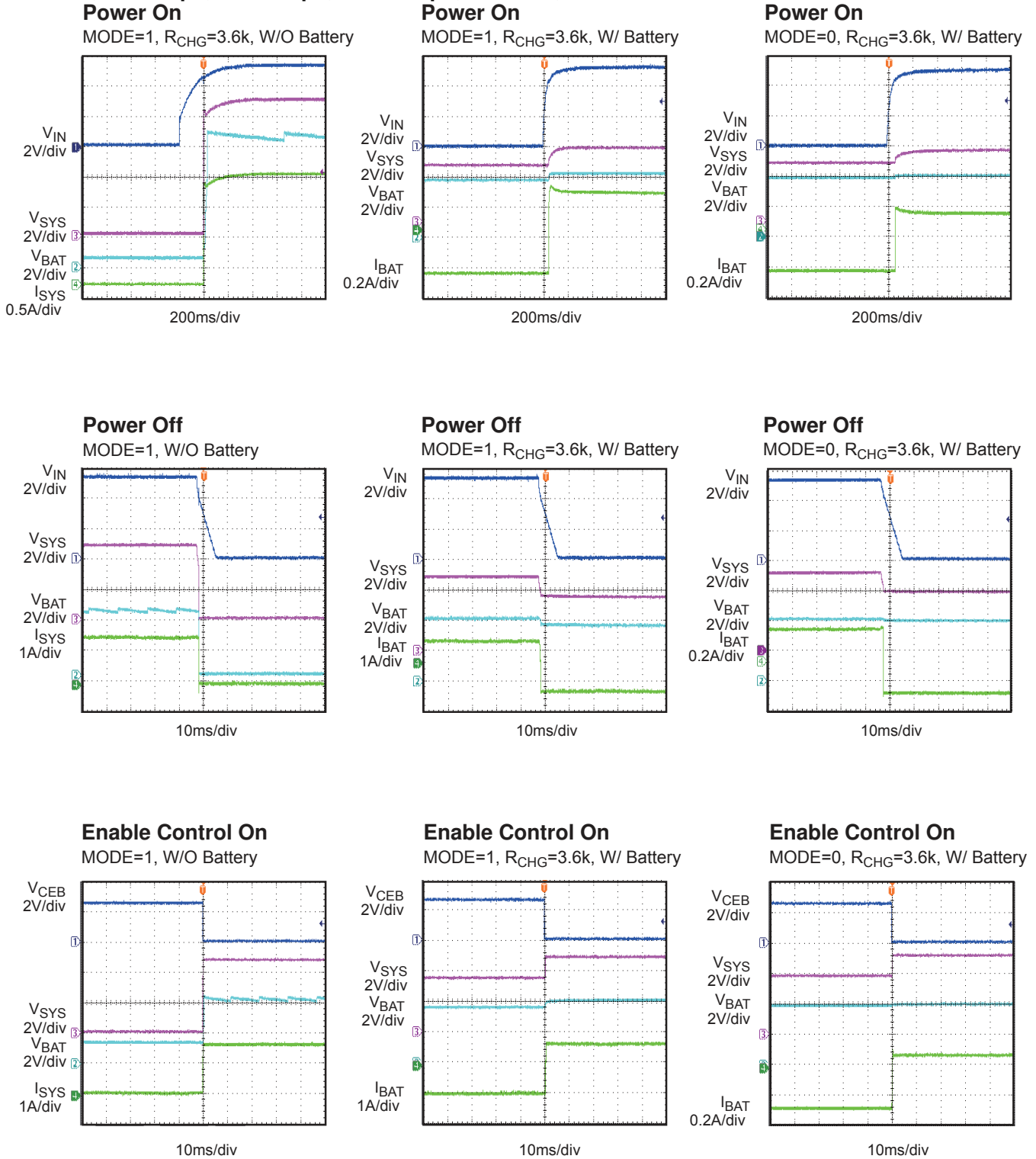
TYPICAL PERFORMANCE CURVES (continued)
 $V_{IN}=5.5V$, $C_{IN}=4.7\mu F$, $C_{SYS}=10\mu F$, $C_{BAT}=4.7\mu F$, $T_A=25^\circ C$, unless otherwise noted.

TYPICAL PERFORMANCE CURVES (continued)
 $V_{IN}=5.5V$, $C_{IN}=4.7\mu F$, $C_{SYS}=10\mu F$, $C_{BAT}=4.7\mu F$, $T_A=25^\circ C$, unless otherwise noted.

Enable Control Off

MODE=1, W/O Battery

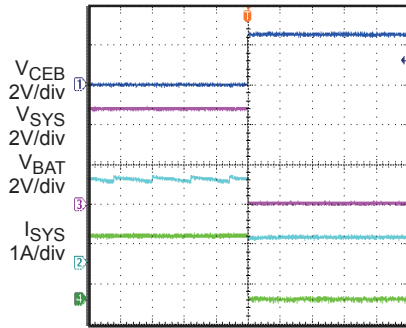

10ms/div

Enable Control Off

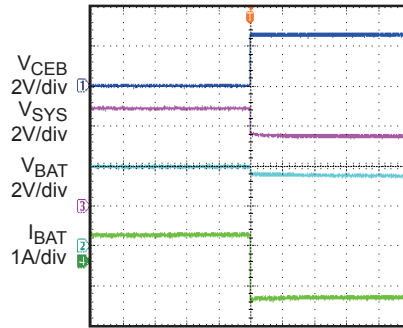
 MODE=1, $R_{CHG}=3.6k$, W/ Battery

10ms/div

Enable Control Off

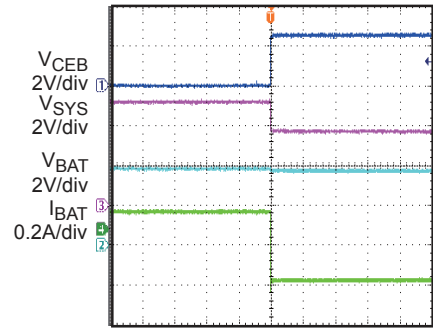
 MODE=0, $R_{CHG}=3.6k$, W/ Battery

10ms/div

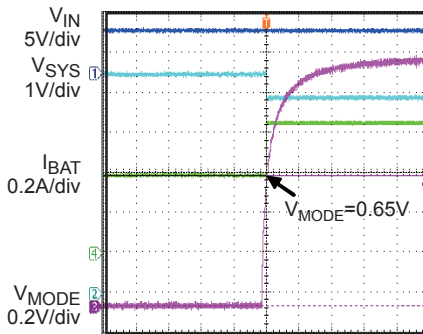
Input Selection
 $R_{CHG}=3.6k$, W/ Battery

200ms/div

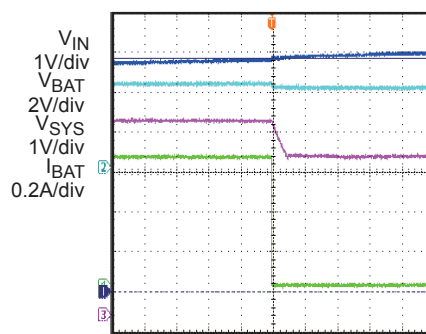
Input OVP
 V_{IN} from 5V to 6V, MODE=1,
 $R_{CHG}=3.6k$, W/ Battery

40ms/div

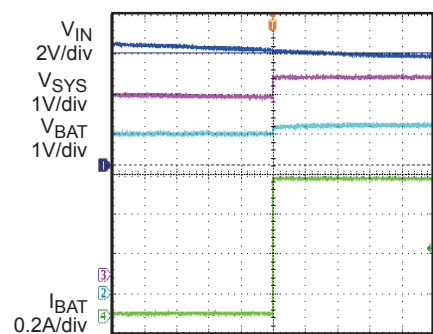
Input OVP Recovery
 V_{IN} from 6V to 5V, MODE=1,
 $R_{CHG}=3.6k$, W/ Battery

40ms/div

BLOCK DIAGRAM

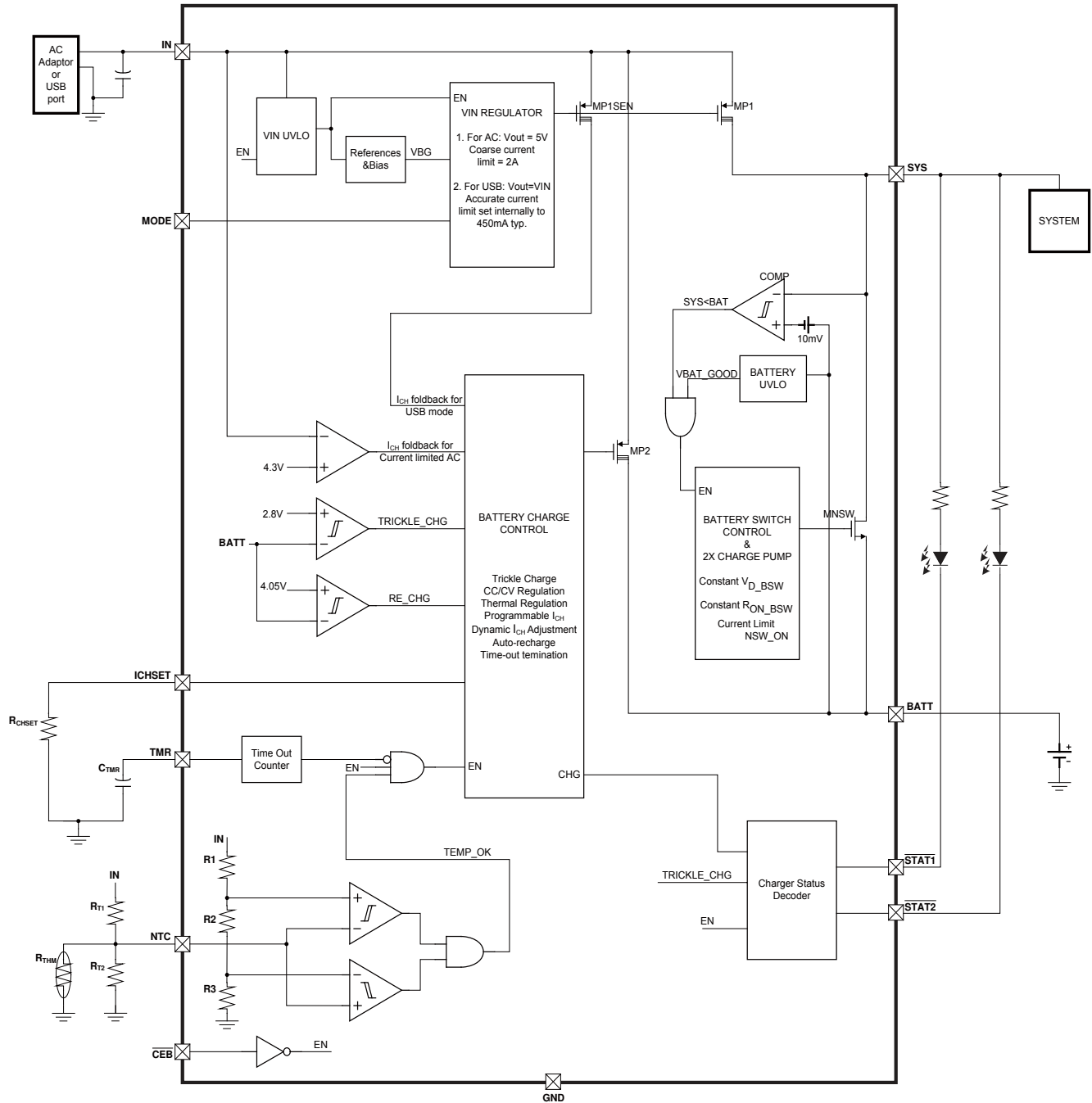

Figure 1—Functional Block Diagram

OPERATION

The MP2607 is a highly-integrated single-cell Li-ion or Li-polymer battery charger with system power path management function. The full function charger features trickle charge, high accuracy constant current (CC) and constant voltage (CV) regulation, charge termination, auto recharge, thermal fold-back, built-in timer and 4-status indicator output. The power path function allows the input source to power the system and charge the battery independently. If there is conflict to meet both system load and battery charging current, MP2607 will automatically reduce charging current or even use battery as supplement to satisfy the system load. This allows optimal battery charging, reduces charge/discharge cycle, and best preserves the battery energy.

Input Selection for Power Path and Charger

MP2607 identifies the input source (IN) based on the logic level of MODE pin. MODE pulled high indicates IN is connected with AC adapter, low indicates IN connected with USB port. In either case, the input source will supply both system load and battery charging current. If IN is not connected to a valid input source, the battery (BATT) is selected to supply the system (SYS). The built-in N-channel 50mΩ switch between BATT and SYS minimizes the conduction drop and extends the battery life.

The IN of MP2607 can accept voltage as high as 13V, thus allows the use of low cost high output ripple adapters.

MODE pin is default “high” with internal pull-up.

Power Path Management

If IN is connected with AC adapter, MP2607 regulates the SYS pin voltage at about 5V with an internal low drop-out regulator. If IN is connected with USB port, SYS is connected to IN through an internal current limited switch. In both cases, the battery charging is done through a P-channel FET between IN and BATT, so the input source supplies both load current to SYS and charging current to BATT. This P-channel FET on-resistance is designed to be less than 0.3ohm to minimize the dropout from IN to BATT. If the sum of SYS load current and BATT charging current will exceed the

source current limit, either AC adapter or USB port, MP2607 automatically reduces the charging current to comply with the source current limit and satisfy SYS load demand (Fig2 and Fig3). For USB mode, if SYS load current further increases beyond the source current limit, SYS voltage will drop to below BATT and MP2607 will turn on the 50mΩ N-channel switch between BATT and SYS to allow battery to supplement the system load (Fig3). The control of this switch has two phases in this battery supplement mode: 1) constant V_{DS} where its voltage drop is regulated. This occurs at low battery supplement current level; 2) constant R_{DS} where the switch is fully on. This occurs at medium to high battery supplement current level; Battery supplement mode ensures the system load is always met and its operation will not be disturbed.

The constant V_{DS} control is enabled only when IN is connected to a valid source, thus allow automatic turn-off of the N-channel switch to avoid overcharge when SYS pin voltage recovers to rise above BATT pin voltage.

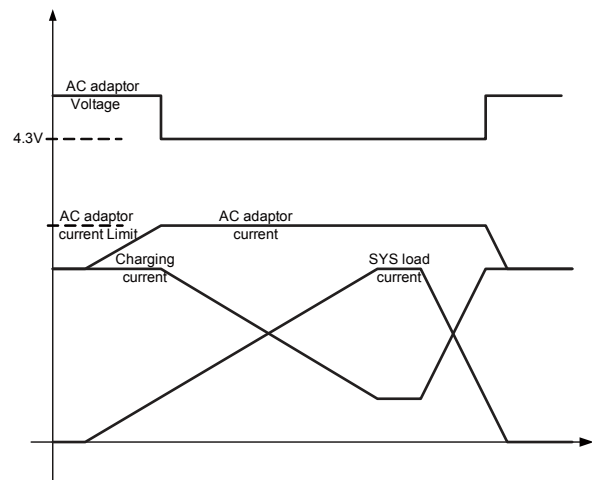

Figure 2—Power Path Management for AC Adapter Mode

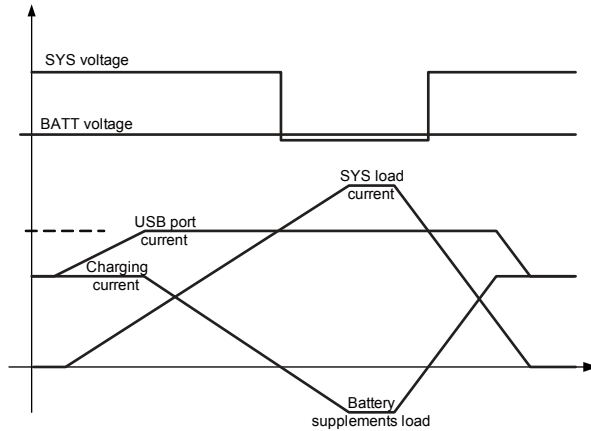

Figure 3—Power Path Management for USB Mode

Power path management allows use of lower current limited sources while still provides continuous system supply and optimal battery charging at the same time.

USB Mode Input Switch Current Limit

When IN is connected to an USB port, the switch between IN and SYS has a built-in current limit that is set by an internal resistor with typical value of 450mA. Post-package trimming keeps the variation within +5%.

Charging Current Thermal Fold-back

MP2607 has internal monitoring circuit that will reduce the charging current if the chip junction temperature reaches 120°C. This prevents overheat of the chip and avoids unnecessary thermal shutdown.

Floating Charging Voltage

The floating voltage for the constant voltage regulation phase is 4.2V. It has ±0.75% accuracy over the ambient temperature range of -10°C to +70°C.

Auto Recharge

MP2607 automatically recharge the battery if BATT pin voltage falls below a predetermined threshold V_{RECHG} . This allows the battery to always stay at full or near full condition, increasing the battery life.

Status Indication output

$\overline{STAT1}$ and $\overline{STAT2}$ are two open-drain NMOS outputs which should be connected to pull-up resistors to SYS output or desired supply rail. Their output logic level combinations are used to indicate 4 status of the charger:

Regardless of the charger status, however, the charger does not turn off as long as a valid input power source is attached.

Charger Status	$\overline{STAT1}$	$\overline{STAT2}$
Charging	Low	Low
End of Charge	Low	High
Charge Suspended (due to Battery supplement mode or NTC out of range)	High	Low
Fault/Disable (due to time-out, internal thermal shutdown), $\overline{EN} > 2V$, or no VIN	High	High

NTC Temperature Sensor

The NTC pin allows MP2607 to sense the ambient temperature using the Negative Thermal Coefficient (NTC) thermistor usually available in the battery pack to ensure a safe operating environment of the battery. A resistor with appropriate value should be connected from VIN to NTC and the NTC resistor parallel connected a regular resistor is connected from NTC pin to ground. The voltage on NTC pin is determined by the resistor divider whose divide ratio depends on the ambient temperature. MP2607 internally sets a pre-determined upper and lower bound of the divide ratio. If NTC pin voltage falls out of this range which means the temperature is outside the safe operating range, MP2607 will stop charging and report it on status pins. Charging will automatically resume after the temperature falls back into the safe range.

Enable

Enable of MP2607 is controlled by pulling \overline{CEB} pin below 0.3V. Pulling \overline{CEB} pin above 2V will put MP2607 in sleep mode, which disables power path management and battery charger. In sleep mode, the N-channel switch between BATT and SYS is fully on to maintain system supply. Battery under-voltage and current limit are kept alive to provide safeguard.

APPLICATION INFORMATION

COMPONENT SELECTION

Battery Charging Current

The charging current of MP2607 is programmable using an external resistor R_{CHG} at ICHSET pin:

$$I_{CHG} = 1800 \times \frac{1.260V}{R_{CHG}(\Omega)}$$

Where 1.260V is an internal reference voltage for ICHSET programming. Typically R_{CHG} is chosen between 1.51k Ω (1.50A I_{CHG}) and 7.5k Ω (300mA I_{CHG}).

However, due to current limit constraint at the input source, either adapter or USB port input, the charging current could be less than above calculated value if system load demand is high. MP2607 will always ensure the sum of system load current and charging current complies with source current limit, with system load has the priority. Especially for USB mode, when system load exceeds the source current limit, charging is actually stopped and battery is pulled in to supplement the system load.

When using USB port as input source, if the charging current is set higher than USB port current limit I_{USB_MAX} , then the real charging current will not be higher than USB current limit and could be reduced further if system draws any load.

End of Charge Threshold Current

The end of charge threshold current is set internally to be at 10% of I_{CHG} :

$$I_{EOC} = 180 \times \frac{1.260V}{R_{CHG}(\Omega)}$$

Where 1.260V is an internal reference voltage and R_{CHG} is the programming resistor at ICHSET pin.

When the charging current falls below I_{EOC} in CV charge mode, MP2607 will terminate charge, and latch the status pin to indicate the end of charge.

Trickle Charge Current

When the battery voltage is below the minimum battery voltage V_{TH_TRKL} (defined in the electrical characteristics table), the charger operates in a trickle/preconditioning mode, where the charging current is typically 7.5% of the programmed charge current I_{CHG} .

$$I_{TRKL} = 150 \times \frac{1.260V}{R_{CHG}(\Omega)}$$

Timer for Charge Termination

MP2607 has a built-in timer to terminate the charge if the timer times out, no matter whether I_{EOC} is reached or not. And once the battery is charged full, the timer is reset. This timer is programmable using an external capacitor C_{TMR} at TMR pin, to allow user adjust to different battery capacity. The timer can be calculated as:

$$\tau_{TMR_F} = 1.1\text{hours} \times \frac{2\mu\text{A} + 1\text{A}/36000}{2\mu\text{A} + I_{CHG}/36000} \times \frac{C_{TMR}}{1\mu\text{F}}$$

The timer period is strictly inversely proportional to the real charging current (either in power path state or CV charge mode), the sink and source current of C_{TMR} is $2\mu\text{A} + I_{chg}/36000$.

So, the trickle charge timer can be calculated based on the τ_{TMR_F} :

$$\tau_{TMR_T} = \tau_{TMR_F} \times \frac{2^{15}}{2^{17}} \times \frac{2\mu\text{A} + I_{CHG}/36000}{2\mu\text{A} + I_{TRKL}/36000}$$

Due to the power path management function, the real charging current usually varies during the whole charging process, thus MP2607 automatically takes into account this variation and adjust the timer time out accordingly. Basically the timer increases the same proportion as the charging current decreases. If the charging is stopped due to high system load, the timer is temporarily suspended. In this way, the actual energy delivered to the battery, which is charging current multiplying the charging time, remains constant.

The time out operation will set the charger into suspended state and be reported at the status output pins. To clear the time out status, one has to recycle the chip enable pin or IN supply.

Resistor Choose for NTC Sensor

NTC pin uses a resistor divider from input source (IN) to sense the ambient temperature. The two resistors R_{T1} and R_{T2} allow the high temperature limit and low temperature limit to be programmed independently. In another word, MP2607 can fit most type of NTC resistor and different temperature operation range requirement with the two extra resistors.

R_{T1} and R_{T2} values depend on the type of the NTC resistor:

$$R_{T2} = \frac{0.3 \times R_{NTCH} \times R_{NTCL}}{0.12 \times R_{NTCL} - 0.42 \times R_{NTCH}}$$
$$R_{T1} = 0.667 \times (R_{T2} / R_{NTCL})$$

R_{NTCH} is the value of the NTC resistor at high temperature of the required temperature operation range, and R_{NTCL} is the value of the NTC resistor at low temperature.

PACKAGE INFORMATION

QFN 14 (3mm x 4mm)

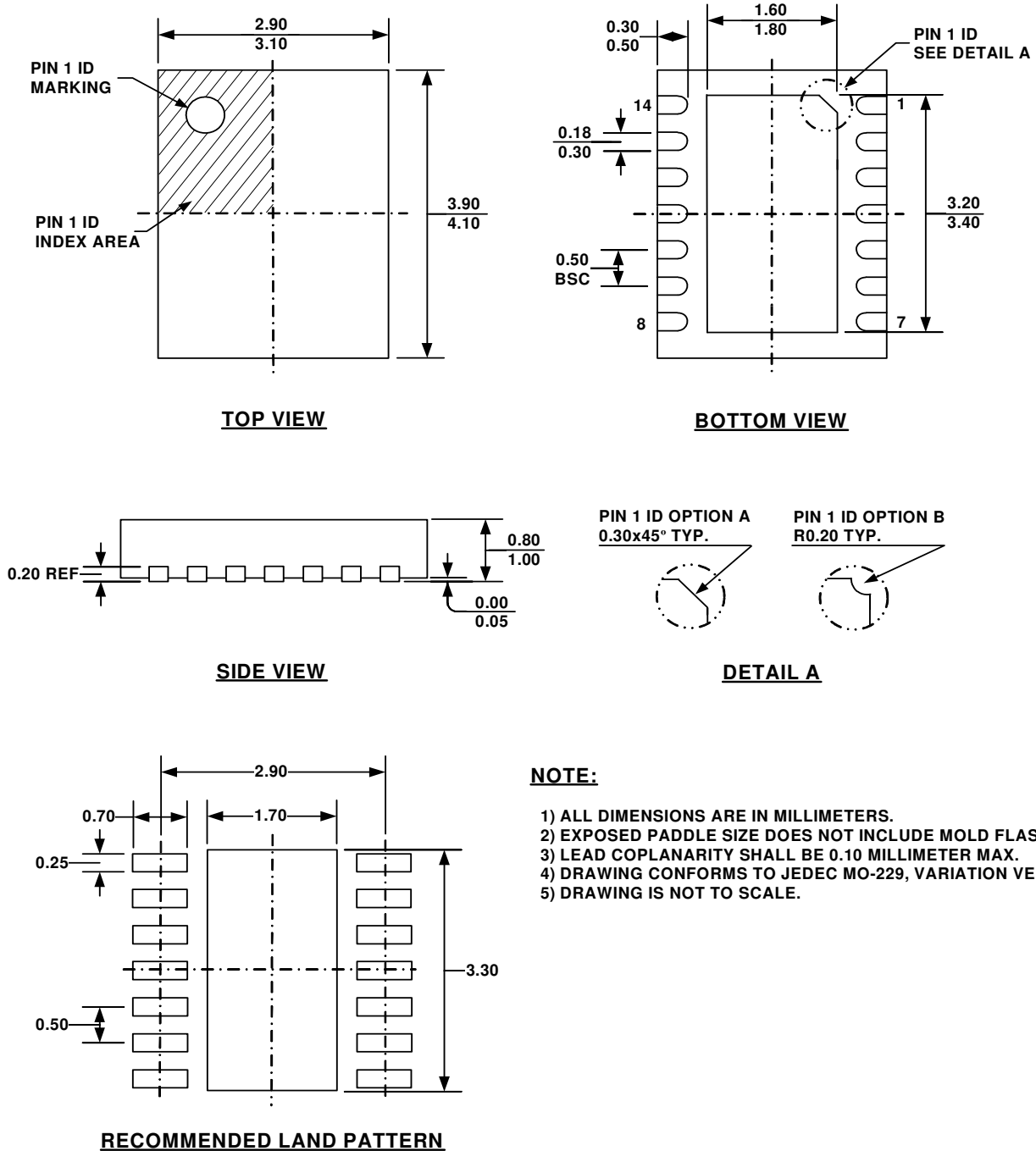

NOTE:

- 1) ALL DIMENSIONS ARE IN MILLIMETERS.
- 2) EXPOSED PADDLE SIZE DOES NOT INCLUDE MOLD FLASH.
- 3) LEAD COPLANARITY SHALL BE 0.10 MILLIMETER MAX.
- 4) DRAWING CONFORMS TO JEDEC MO-229, VARIATION VEED-5.
- 5) DRAWING IS NOT TO SCALE.

NOTICE: The information in this document is subject to change without notice. Please contact MPS for current specifications. Users should warrant and guarantee that third party Intellectual Property rights are not infringed upon when integrating MPS products into any application. MPS will not assume any legal responsibility for any said applications.