

DESCRIPTION: QUICK RELEASE - DIE CAST

SPECIFICATION:
 MATERIAL: ZINC ALLOY, ZAMAK Z0410

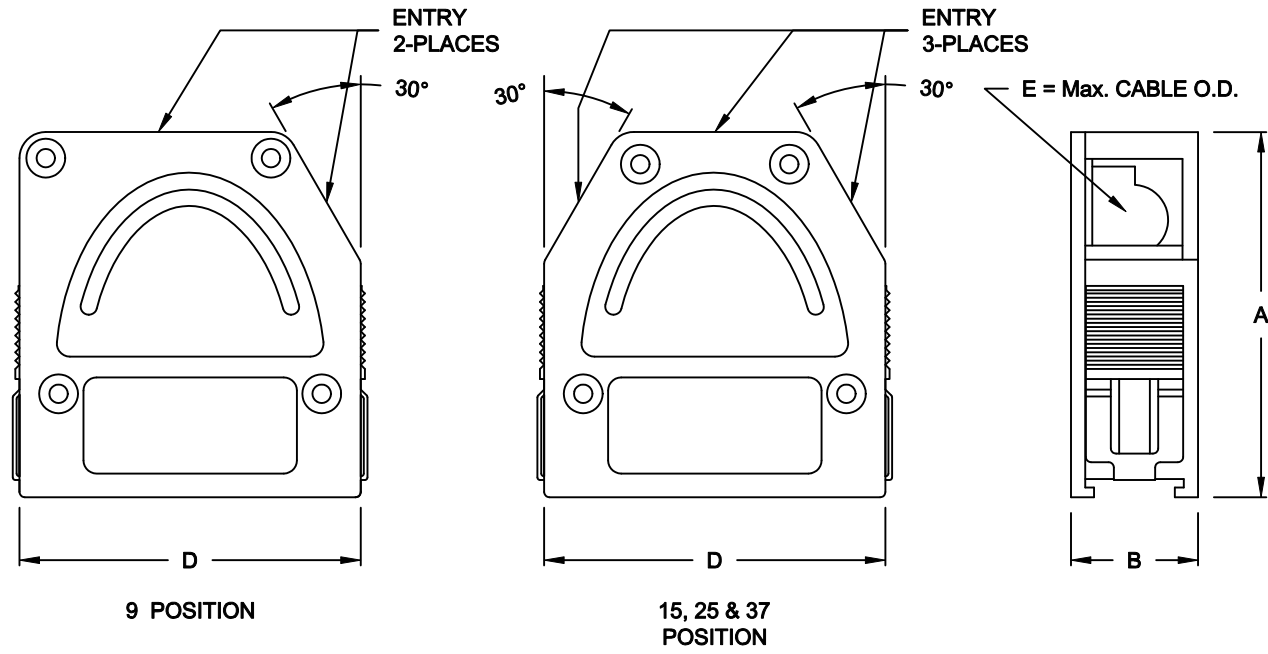

BACKSHELL KIT INCLUDES:

- (2) BACKSHELL HALVES
- (4) MOUNTING SCREWS
- (1) GROUNDING SCREW

 *** CABLE CLAMP ORDERED SEPARATELY ***
 *** SEE SHEET 2 ***

955-YYY-030R121

SERIES _____
 POSITIONS _____
 009
 015
 025
 037
 MATERIAL _____
 030 = DIE CAST
 RoHS COMPLIANT _____
 R = HIGH TEMP. PROCESS
 COLOR _____
 12 = METAL(IZED)
 PUT-UP _____
 1 = KIT

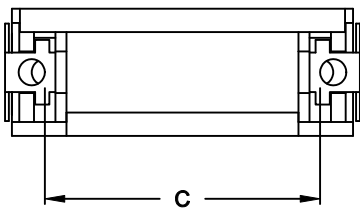

DIMENSIONS (IN.)					
No. OF PINS	A	B	C	D	E
09	1.740	0.606	0.984	1.299	0.354
15	1.740	0.606	1.312	1.626	0.394
25	1.740	0.606	1.852	2.165	0.433
37	1.740	0.606	2.500	2.815	0.433

DO NOT SCALE FROM DRAWING

	THESE DRAWINGS AND SPECIFICATIONS ARE THE PROPERTY OF NorComp AND SHALL NOT BE REPRODUCED, COPIED OR USED AS THE BASIS FOR THE MANUFACTURE OF SALE OF APPARATUS WITHOUT WRITTEN PERMISSION.		DRAWN: C. SMITH	DATE: 04-10-07
			CHECKED:	DATE:
<h1>NorComp</h1>	SCALE: 1:1	SHEET 1 OF 2	REV 1	
	DWG NO. 955-YYY-030R121			

RoHS COMPLIANT

CABLE CLAMPS ORDERED SEPARATELY

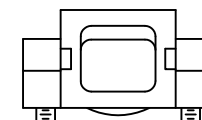
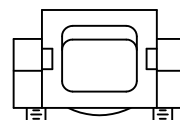
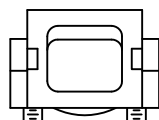
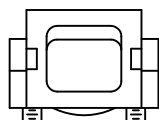
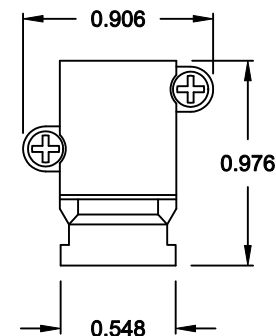
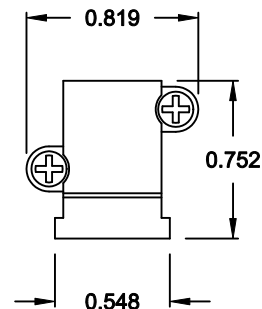
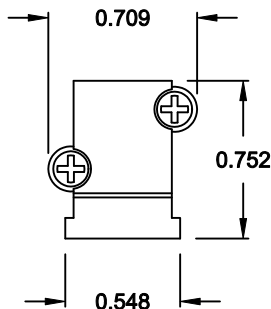
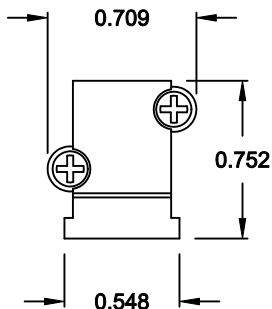
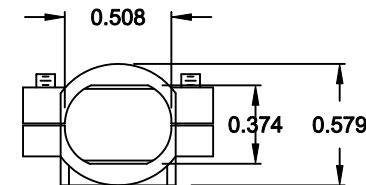
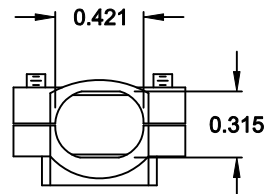
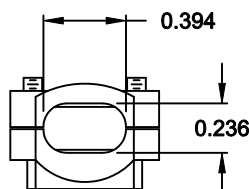
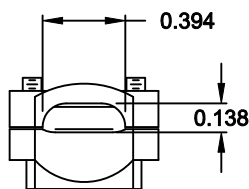

P/N 955-09-SR-4-7
CABLE RANGE = 0.157 - 0.276

P/N 955-15-SR-7-10
CABLE RANGE = 0.276 - 0.394

P/N 955-25-SR-9-12
CABLE RANGE = 0.354 - 0.472

P/N 955-37-SR-11-14
CABLE RANGE = 0.433 - 0.551

DO NOT SCALE FROM DRAWING



THESE DRAWINGS AND SPECIFICATIONS ARE THE PROPERTY OF NorComp AND SHALL NOT BE REPRODUCED, COPIED OR USED AS THE BASIS FOR THE MANUFACTURE OF SALE OF APPARATUS WITHOUT WRITTEN PERMISSION.

DRAWN:
C. SMITH

DATE:
04-10-07

CHECKED:

DATE:

NorComp

SCALE: 1:1 SHEET 2 OF 2 REV 1

DWG NO. 955-YYY-030R121

RoHS COMPLIANT