

# Photon Detection Solutions

For Smart, Safe and Sustainable Applications - 3.3



Together we create a Smart World.



**EXCELITAS**  
TECHNOLOGIES®

# Photon Detection Solutions

## for your cutting-edge applications

At Excelitas we're sensing what you need for a healthier, safer, and more innovative tomorrow. Excelitas is recognized globally for the design and production of high-performance photonic detectors and pulsed laser diodes which contribute to a safer, greener and more comfortable world, every day. Our detection portfolio ranges from PN-, PIN- and APD Photodiodes, utilizing Silicon and InGaAs materials for sensitivity from 400 nm to 1700 nm, Single Photon Counting Modules and Balanced Receivers to detect the smallest amount of light possible, to Pulsed Laser Diodes emitting at 905 nm and 1550 nm. These products enable our customers to develop devices at the forefront of technology. With our decades of experience in Smoke Detection applications, we have developed and produced a highly sensitive smoke detector module that can easily integrate into the PCBA process and enables faster speed to market.

### ■ SECTION 1 • AVALANCHE PHOTODIODES

- Silicon APDs
- InGaAs APDs

### ■ SECTION 2 • PIN PHOTODIODES

- Silicon PIN Photodiodes
- InGaAs PIN Photodiodes

### ■ SECTION 3 • OPTICAL RECEIVERS

- Silicon Optical Receivers
- InGaAs Optical Receivers

### ■ SECTION 4 • LOW LIGHT LEVEL (L<sup>3</sup>D) DETECTORS & MODULES

- Single Photon Counting Modules (SPCM)
- Coherent InGaAs PIN Balanced Receiver Module

### ■ SECTION 5 • PULSED LASER DIODES

- 905 nm Pulsed Laser Diodes

### ■ SECTION 6 • APPLICATION SPECIFIC COMPONENTS & MODULES

- Smoke Detection
- Radon Detection
- Ambient Light

### ■ SECTION 7 • SILICON PHOTODIODE ARRAYS

- VTA Series

### ■ SECTION 8 • SILICON PN PHOTODIODES

- Blue-enhanced VTB Series
- High-Speed VTP Series
- Industry Standard VTD Series

### ■ SECTION 9 • INFRARED EMITTING DIODES

- 880 nm IREDS
- 940 nm IREDS

<b>SECTION 1</b>	
Avalanche Photodiodes	4
<b>SECTION 2</b>	
PIN Photodiodes	11
<b>SECTION 3</b>	
Optical Receivers	13
<b>SECTION 4</b>	
Low Light Level (L <sup>3</sup> D) Detectors & Modules	15
<b>SECTION 5</b>	
Pulsed Laser Diodes	18
<b>SECTION 6</b>	
Application Specific Components & Modules	21
<b>SECTION 7</b>	
Silicon Photodiode Arrays	24
<b>SECTION 8</b>	
Silicon PN Photodiodes	26
<b>SECTION 9</b>	
Infrared Emitting Diodes	34

# Avalanche Photodiodes

AVALANCHE PHOTODIODES ■

Avalanche Photodiodes  
Silicon APDs



## Silicon APDs

### Applications

- Laser range finder
- Scanning video imager
- Confocal microscope
- Free space communication
- Spectrophotometers
- Fluorescence detection
- Luminometer
- DNA sequencer
- Particle sizing

### Features and Benefits

- Low noise
- High gain
- High quantum efficiency
- Built-in TE-cooler option
- Various optical input options
- Customization available upon request

### Product Description

These rear entry “reach-through” silicon APDs offer the best compromise in terms of cost and performance for applications requiring high speed and low noise photon detection from 400 nm up to 1100 nm. They feature low noise, high quantum efficiency and high gain while maintaining reasonably low operating voltage. The active area varies from 0.5 mm to 3 mm to accommodate a large variety of applications.

The “S” series of the C30902 family of APDs can be used in either their normal linear mode ( $V_R < V_{BR}$ ) or for photon counter in the Geiger mode ( $V_R > V_{BR}$ ). This series is particularly well-suited for ultra-sensitive photon measurements in biomedical and analytical instruments. Precise temperature control can be achieved with a thermo-electric cooler which can be used to improve noise and responsivity or to maintain constant responsivity over a wide range of ambient temperature.

These APDs can also be incorporated into a hermetically-sealed TO-8 package with ultra-low noise preamplifier (C30659 series APD receivers) and thermo-electric cooler (LLAM series receivers) for optimum signal to noise performance.

Product Table

### Avalanche Photodiodes – Silicon APDs

Unit	Active Diameter mm	Typical Capacitance pF	Typical Rise/Fall Time ns	Typical Dark Current nA	Breakdown Voltage min V	Breakdown Voltage max V	Temp. Coefficient V/°C	Typical Gain	Responsivity 800 nm A/W	Responsivity 900 nm A/W	Responsivity 1060 nm A/W	NEP @900 nm fW/√Hz	Package
<b>C30724EH</b>	0.5	1.0	5	20	-	350	-	15	6.5	8.5	2	12	TO-18
<b>C30724PH</b>	0.5	1.0	5	20	-	350	-	15	6.5	8.5	2	12	T-1¾
<b>C30817EH</b>	0.8	2	2	50	300	475	2.2	120	-	18	-	20	TO-5
<b>C30884EH</b>	0.8	4	1	< 75	190	290	1.1	100	-	63	8	13	TO-5
<b>C30916EH</b>	1.5	3	3	100	315	490	2.2	80	-	50	12	20	TO-5

The C30724, as a low gain APD, can be operated at a fixed voltage without the need for temperature compensation.



Product Table

**Avalanche Photodiodes – Silicon APDs – TE-Cooled**

Unit	Active Diameter	Typical Capacitance	Typical Rise/Fall Time	Typical Dark Current	Breakdown Voltage min	Breakdown Voltage max	typ. Unit =	Typical Gain	Responsivity 830 nm	Responsivity 900 nm	Typical Noise Current	Package
	mm	pF	ns	nA	V	V	V/°C		A/W	A/W	pA/√Hz	
<b>C30902BH</b>	0.5	1.5	0.4	7	185	260	0.7	150	80	66	0.23	Ball lens TO-18
<b>C30902EH</b>	0.5	1.5	0.4	7	185	260	0.7	250	135	66	0.23	TO-18, flat window
<b>C30902EH-2</b>	0.5	1.5	0.4	7	185	260	0.7	250	-	66	0.23	TO-18, built-in 905 nm filter
<b>C30902SH</b>	0.5	1.5	0.4	7	185	260	0.7	80	128	110	0.11	TO-18, flat window
<b>C30902SH-2</b>	0.5	1.5	0.4	7	185	260	0.7	250	-	110	0.11	TO-18, built-in 905 nm filter
<b>C30902SH-TC</b>	0.5	1.5	0.4	2	185	260	0.7	250	128	110	0.04	TO-8 flange
<b>C30902SH-DTC</b>	0.5	1.5	0.4	1	185	260	0.7	250	128	110	0.02	TO-8 flange
<b>C30902BSTH</b>	0.5	1.5	0.4	7	185	260	0.7	150	80	66	1.5	ST receptacle

TC stands for single stage cooler, operating temperature 0°C  
DTC stands for double stage cooler, operating temperature -20°C

Graph 1

**Typical Spectral Responsivity @ 22°C**

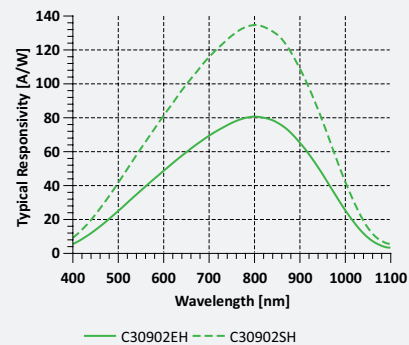

Figure 1

**Package Drawing – TO-8 Flange**

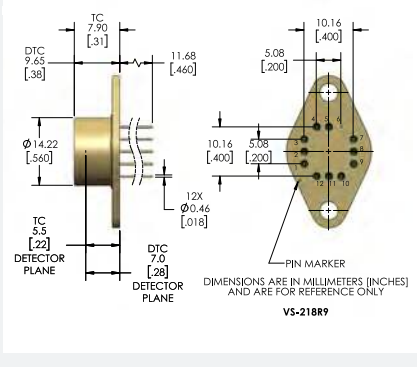

Figure 2

**Typical TO-5 Package\***

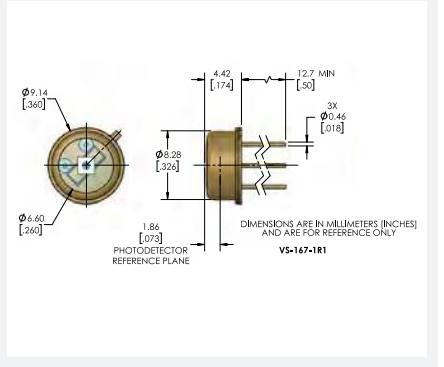

Figure 3

**Typical TO-8 Package\***

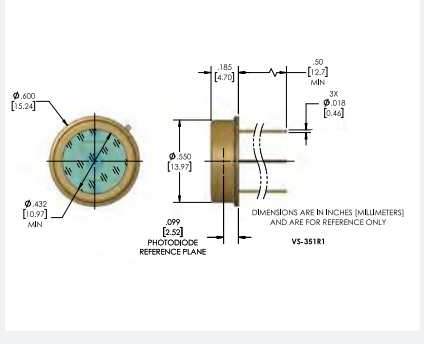

Figure 4

**Typical TO-18 Package\***

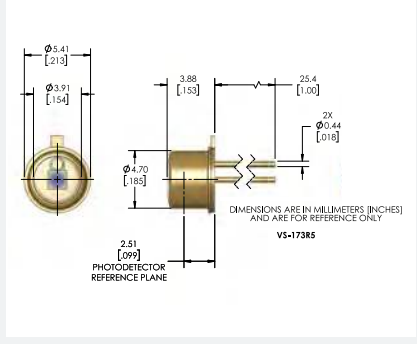
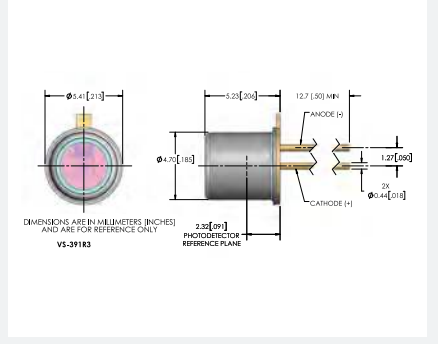

Figure 5

**Typical TO-18 Package with filter\***



\*Note: Package dimensions for indication only. Exact package dimensions can be found on products datasheets.

# Avalanche Photodiodes

AVALANCHE PHOTODIODES ■

Avalanche Photodiodes  
1060 nm NIR Enhanced Si APDs

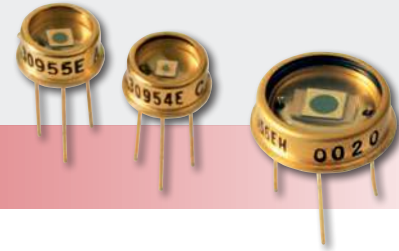

## 1064 nm NIR Enhanced Si APDs

### Applications

- Range finding
- LiDAR (Light Detection And Ranging)
- YAG laser detection

### Features and Benefits

- High quantum efficiency at 1060 nm
- Fast response time
- Wide operating temperature range
- Low capacitance
- Hermetically-sealed packages
- RoHS compliant
- Customization available upon request

### Product Description

The C30954EH, C30955EH, and C30956EH are general purpose silicon avalanche photodiodes made using a double-diffused "reach-through" structure. The APD design is optimized for 1064nm operation.

These APDs have quantum efficiency of up to 40% at 1064 nm. At the same time, the diodes retain the low noise, low capacitance, and fast rise and fall times characteristics.

To help simplify many design needs, these APDs are also available in Excelitas' high-performance hybrid preamplifier module type C30659 series, as well as the preamplifier and TE cooler incorporated module type LLAM series. In addition, these APDs are also available with built-in thermo-electric cooler for easier temperature control. Please refer to the respective sections in this catalog.

Product Table

### Si APDs – NIR Enhanced

Part Number	Photo Sensitive Diameter	Typical Responsivity @ 1060 nm	Typical Dark Current	Spectral Noise Current	Capacitance @ 100 KHz	Response Time	NEP @ 1060 nm	Vop Range
Unit	mm	A/W	nA	pA/√Hz	pF	ns	fW/√Hz	V
<b>C30954EH</b>	0.8	36	50	1.0	2	2	28	300 - 475
<b>C30955EH</b>	1.5	34	100	1.0	3	2	29	315 - 490
<b>C30956EH</b>	3.0	25	100	1.1	10	2	44	325 - 500

TC stands for single stage cooler, operating temperature 0° C  
DTC stands for double stage cooler, operating temperature -20° C

Graph 1

### Spectral Responsivity Characteristics

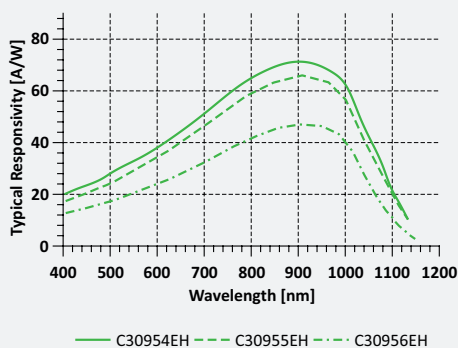

\*Note: Package dimensions for indication only. Exact package dimensions can be found on products datasheets.

Figure 1

### Package Drawing – C30954EH, C30955EH

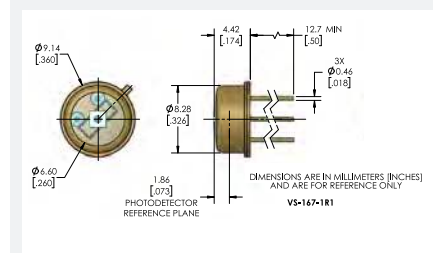
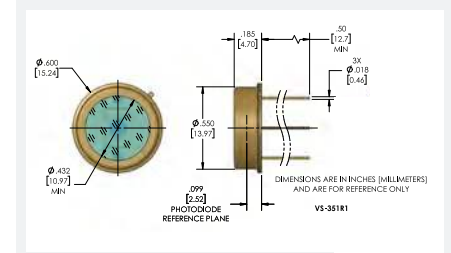

Figure 2

### Package Drawing – C30956EH



Product Table

### Silicon APD – TE-Cooled

Unit	Active Diameter	Active Area	Total Capacitance	Rise/Fall Time	Dark Current	Breakdown Voltage min	Breakdown Voltage max	Temperature Coefficient	Typical Gain	Responsivity 830 nm	Responsivity 900 nm	Responsivity 1060 nm	Noise Current	Package
	mm	mm <sup>2</sup>	pF	ns	nA	V	V			A/W	A/W	A/W	pA/√Hz	
<b>C30954EH-TC</b>	0.8	0.5	2	2	8	300	475	2.4	120	-	75	36	0.2	TO-8 flange
<b>C30955EH-TC</b>	1.5	1.8	3	2	15	315	490	2.4	100	-	70	34	0.2	TO-8 flange
<b>C30956EH-TC</b>	3	7	10	2	15	325	500	2.4	75	-	45	25	0.2	TO-8 flange

# Avalanche Photodiodes

## AVALANCHE PHOTODIODES ■

Avalanche Photodiodes Si APD Arrays

### Si APD Arrays

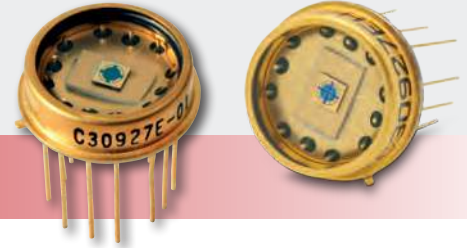

#### Applications

- Spectroscopy
- Particle detection
- Spot tracking and alignment systems
- Adaptive optics
- LiDAR (Light Detection And Ranging)

#### Features and Benefits

- High quantum efficiency
- Hermetically-sealed packages
- Monolithic chip with minimal dead space between elements
- Specific tailored wavelength response
- RoHS compliant
- Customization available upon request

#### Product Description

The C30927 series of quadrant Si Avalanche Photodiode utilize the double-diffused “reach-through” structure. This structure provides ultra-high sensitivity at 400 nm -1100 nm.

The C30927 quadrant structure has a common avalanche junction, with separation of the quadrants achieved by segmentation of the light entry p+ surface opposite the junction. With this design, there is no dead space between the elements and therefore no loss of response at boresight.

The C30927EH-01, -02 and -03 are optimized for use at wavelengths of 1060 nm, 900 nm, and 800 nm respectively. Each device type will provide high responsivity and excellent performance when operated within about 50 nm of the specified wavelength.

Product Table

### Avalanche Photodiodes – Si APD Arrays

Part Number	Number of Elements	Photo Sensitive Diameter	Typical Responsivity	Dark Current per Element	Total Spectral Noise Current	Capacitance @ 100 KHz per Element	Typical Rise/Fall Time	NEP	Operating Voltage
Unit		mm	A/W	nA	pA/√Hz	pF	ns	fW/√Hz	V
C30927EH-01	4	1.55	15(@ 1060 nm)	25	1.0	< 0.5	3	66 @ 1060 nm	275 - 425
C30927EH-02	4	1.55	62(@ 900 nm)	25	1.0	< 0.5	3	16 @ 900 nm	275 - 425
C30927EH-03	4	1.55	55(@ 800 nm)	25	1.0	< 0.5	3	18 @ 800 nm	275 - 425

Figure 1

### Package Drawing – C30638EH and C30985E

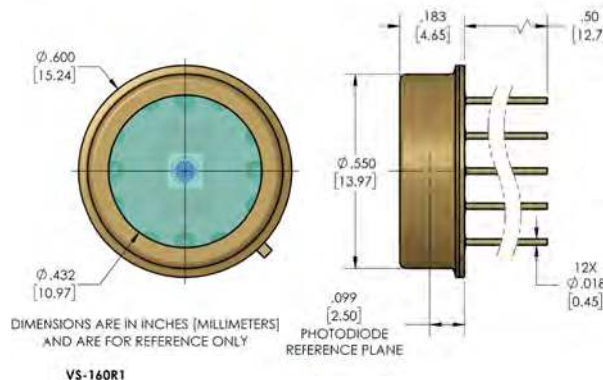

# Avalanche Photodiodes

## AVALANCHE PHOTODIODES ■

Large Area Si-APDs – UV-Enhanced APDs

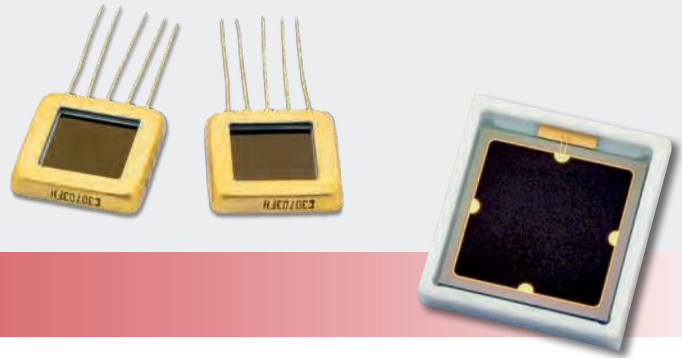

## Large Area Si-APDs – UV-Enhanced APDs

### Applications

- Nuclear medicine
- Fluorescence detection
- High energy physics
- Medical imaging
- Radiation detection
- Particle physics
- Instrumentation
- Environmental monitoring

### Features and Benefits

- High quantum efficiency
- Low dark currents
- Easy coupling to scintillator crystals
- Immunity to electromagnetic fields
- Custom packaging available
- Excellent timing resolution
- RoHS compliant
- Customization available upon request

### Product Description

The C30739ECERH Silicon Avalanche Photodiode (APD) is intended for use in a wide variety of broadband low light level applications covering the spectral range from below 400 nm to over 700 nm. It has low noise, low capacitance and high gain. It is designed to have an enhanced short wavelength sensitivity, with quantum efficiency of 80 % at 430 nm.

The standard ceramic carrier package allows for easy handling and coupling to scintillating crystals such as LSO and BGO. Combined with the superior short wavelength responsivity, it makes this APD ideal in demanding applications such as Positron Emission Tomography (PET).

The C30626FH and C30703FH series are large area Si APDs in flat pack packages for either direct detection or easy coupling to scintillator crystals.

The C30626 uses a standard reach through structure and has peak detection at about 900 nm. The C30703 is enhanced for blue wavelength response and has peak quantum efficiency at ~ 530 nm. These APDs are packaged in a square flat pack with or without windows or on ceramics. The devices without window can detect direct radiation of X-rays and electrons at the energies listed, and the windowed packages are best for easy scintillator coupling.

Graph 1

### Quantum Efficiency vs. Wavelength

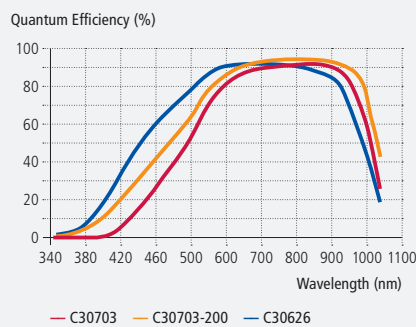

Graph 2

### Quantum Efficiency vs. Wavelength

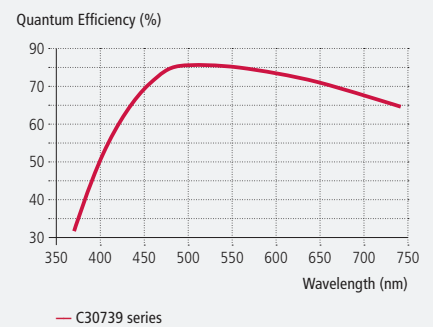

Product Table

### Large Area Si-APDs – UV-Enhanced APDs

Part Number	Photo Sensitive Area	Responsivity	Dark Current	Spectral Noise Current	Capacitance @ 100 KHz	Response Time	NEP	Vop Range
Unit	mm <sup>2</sup>	A/W	nA	pA/√Hz	pF	ns	fW/√Hz	V
C30626FH	5 x 5	22 (@900 nm)	250	0.5	30	5	23 (@900 nm)	275 - 425
C30703FH	10 x 10	16 (@530 nm)	250	0.5	100	5	40 (@530 nm)	275 - 425
C30703FH-200	10 x 10	16 (@530 nm)	250	0.7	60	5	40 (@530 nm)	275 - 425
C30739ECERH	5.6 x 5.6	26 (@430 nm)	1.5	0.3	60	2	12 (@ 430 nm)	400 - 450
C30739ECERH-2	5.6 x 5.6	52(@430 nm)	2.0	0.4	60	2	8 (@ 430 nm)	400 - 450



# Avalanche Photodiodes

## AVALANCHE PHOTODIODES ■

From Left to Right: C30737MH (Compact, top-looking SMD)  
 C30737EH (Through-Hole Package)  
 C30737CH (Top/side-looking SMD)  
 C30737LH (Top-looking SMD)  
 C30737PH (Through-Hole Package)

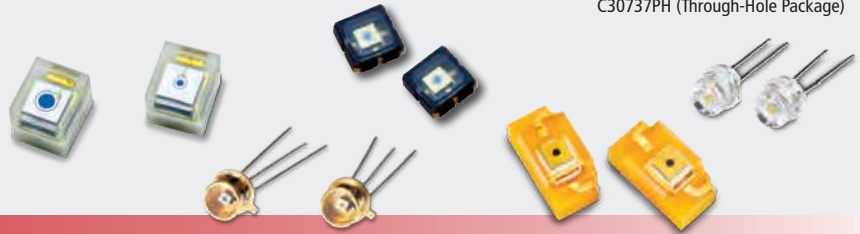

## C30737 High Speed, Low Voltage APD – C30724 Low Temperature Coefficient APD

### Applications

- LiDAR
- Laser range finding
- Optical communication
- Analytical instrumentation
- 3D Laser scanning
- Communication Systems
- Gesture Recognition

### Features and Benefits

- Optimized versions for peak responsivity at 900 nm or 800 nm for high bandwidth operation
- Standard versions with 230  $\mu\text{m}$  500  $\mu\text{m}$  active diameter
- Various package types: hermetic TO, plastic TO, SMD top-and side-looking
- High gain at low bias voltage
- Low breakdown voltage
- Fast response,  $t_R \sim 300$  ps
- Low noise, in  $\sim 0.1$  pA/ $\sqrt{\text{Hz}}$
- RoHS compliant
- Customization including arrays available upon request

### Product Description

The Excelitas C30737 series silicon APDs provide high responsivity between 500 nm and 1100 nm as well as extremely fast rise times at all wavelengths, with a frequency response above 1 GHz for some versions. The C30724, as a low gain APD, can be operated at a fixed voltage without the need for temperature compensation.

Standard versions of the C30737 are available in two active area sizes: 230  $\mu\text{m}$  and 500  $\mu\text{m}$  diameter. They are offered in the traditional hermetic TO housing ("EH"), in cost-effective plastic through-hole T-1 $\frac{3}{4}$  (TO-like, "PH") packages, in leadless ceramic carrier (LCC, "LH") top-looking package and laminated leadless ceramic (LLC, "CH") side-looking package and in a compact SMD "top-looking" leadless package (C30737MH). All listed varieties are ideally suited for high-volume, cost efficient applications.

Customization of these APDs is offered to meet your design challenges. Operating voltage selection and binning or specific wavelength filtering options are among many of the application-specific solutions available.

Graph 1

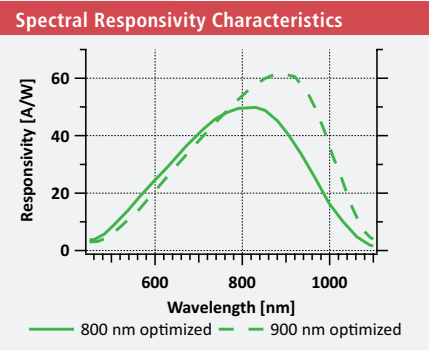

Product Table

### C30737 Epitaxial Silicon APD – C30724 Low-Gain APD

Part Number	Optical Bandpass Filter	Active Area Diameter $\mu\text{m}$	Peak Responsivity	Breakdown Voltage Range V	Temp. Coefficient	Dark Current nA	Dark Noise pA/ $\sqrt{\text{Hz}}$	Capacitance pF	Rise / Fall time ns	Responsivity @ M=100	NEP fw/rt Hz
	Peak nm		typ nm		typ V/C					typ A/W	
C30737XX-230-80	--	230	800	120 ... 210	0.5	0.05	0.1	1	0.3	50	2.00
C30737XX-230-90	--	230	900	180 ... 260	1.3	0.05	0.1	0.6	0.9	60	1.67
C30737XX-500-80	--	500	800	120 ... 210	0.5	0.1	0.1	2	0.3	50	2.00
C30737XX-500-90	--	500	900	180 ... 260	1.3	0.1	0.1	1	0.9	60	1.67
C30737LH-230-81	635	230	635	120 ... 210	0.5	0.05	0.1	1	0.3	35	2.86
C30737LH-230-83	650	230	650	120 ... 210	0.5	0.05	0.1	1	0.3	35	2.86
C30737LH-230-92	905	230	905	180 ... 260	1.3	0.05	0.1	0.6	0.9	60	1.67
C30737EH-230-92	905	230	905	180 ... 260	1.3	0.05	0.1	0.6	0.9	60	1.67
C30737LH-500-81	635	500	635	120 ... 210	0.5	0.1	0.1	2	0.3	35	2.86
C30737LH-500-83	650	500	650	120 ... 210	0.5	0.1	0.1	2	0.3	35	2.86
C30737LH-500-92	905	500	905	180 ... 260	1.3	0.1	0.1	1	0.9	60	1.67
C30737EH-500-92	905	500	905	180 ... 260	1.3	0.1	0.1	1	0.9	60	1.67

Electrical Characteristics at  $T_{\text{ambient}} = 22$  °C; at operating voltage,  $V_{\text{op}}$

# Avalanche Photodiodes

## AVALANCHE PHOTODIODES ■

Avalanche Photodiodes  
Silicon InGaAs APDs

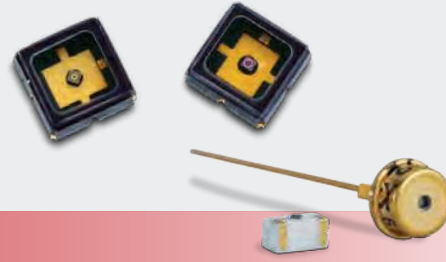

## Avalanche Photodiodes – InGaAs APDs

### Applications

- LiDAR / ToF measurements
  - Eye-safe Laser range finding
  - High volume consumer applications
  - Optical time-domain reflectometer (OTDR)
  - Optical communication systems
  - Laser scanning
- Confocal microscope
- Free space communication
- Spectrophotometers
- Fluorescence detection
- DNA sequencer
- Particle sizing

### Features and Benefits

- Low noise
- High gain
- High quantum efficiency
- Built-in TE-cooler option
- Various optical input options
- Customization available upon request

### Product Description

The C30644, C30645 and C30662 Series APDs are high speed InGaAs/InP avalanche photodiodes. These devices provide large quantum efficiency, (QE), high responsivity and low noise in the spectral range between 1100 nm and 1700 nm, with standard active areas up to 200  $\mu\text{m}$  in diameter. They are optimized for use at a wavelength of 1550 nm, ideally suitable for use in eye-safe laser range finding systems.

These APDs are supplied in a hermetically-sealed TO-18 package, with the chip mounted close to the window to allow easy interfacing with the optical system, or on a ceramic carrier and SMD package. The C30645 and C30662 series APD are offered in the C30659 series of APD receivers with low noise transimpedance amplifier, as well as built-in thermo-electric cooler (the LLAM series). For these modules, please refer to the respective sections in this catalog. Other custom package are also available on request.

Product Table

### InGaAs APD

Unit	Active Diameter $\mu\text{m}$	Capacitance pF	Typical Bw MHz	Dark Current nA	Breakdown Voltage min V	Breakdown Voltage max V	Temperature Coefficient V/ $^{\circ}\text{C}$	Typical Gain	Responsivity 1550 nm A/W	NEP fW/ $\sqrt{\text{Hz}}$	Package
C30644EH	50	0.6	2000	25	45	70	0.14	10	9.3	15	TO-18
C30644ECERH	50	0.6	2000	25	45	70	0.14	10	9.3	15	Ceramic carrier
C30645EH	80	1.25	> 1000	3	45	70	0.14	10	9.3	25	TO-18
C30645EH-1	80	1.25	> 1000	3	45	70	0.14	10	9.3	25	TO-18, Small aperture, Silicon
C30645ECERH	80	1.25	> 1000	3	45	70	0.14	10	9.3	25	Ceramic carrier
C30645L	80	1.25	> 1000	3	45	70	0.14	10	9.3	25	SMD LLC
C30662EH	200	2.5	850	45	45	70	0.14	10	9.3	75	TO-18, Large aperture, Glass
C30662EH-1	200	2.5	850	45	45	70	0.14	10	9.3	75	TO-18, Large aperture, Glass
C30662ECERH	200	2.5	850	45	45	70	0.14	10	9.3	75	Ceramic carrier
C30662ECERH-1	200	2.5	850	45	45	70	0.14	10	9.3	75	Ceramic carrier
C30662EH-3	200	2.5	850	45	45	70	0.14	10	9.3	75	TO-18, Small aperture, Glass
C30662L	200	2.5	850	45	45	70	0.14	10	9.3	75	SMD LLC

NOTE: The "-1" version of the C30662 series have a Vbr-Vop of >4V.

# PIN Photodiodes

## PIN PHOTODIODES ■

PIN Photodiodes  
InGaAs and Si PIN Diodes,  
Quadrant Detectors,  
UV-Enhanced

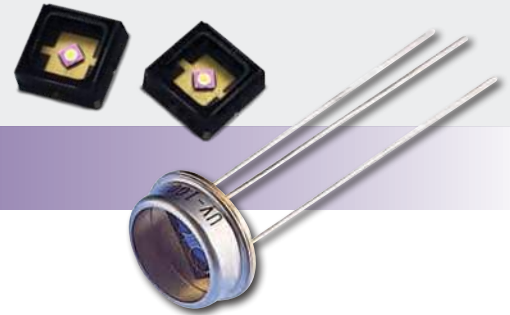

## Si and InGaAs PIN Diodes and Quadrants

### Applications

- LiDAR
- Telecom
- Instrumentation
- Photometry
- Laser power monitoring
- Fiber optic test equipment
- High speed switching
- Spot tracking
- Laser range finders
- Missile guidance
- Laser warning system

### Features and Benefits

- High speed
- High responsivity
- Hermetically-sealed
- Large area available
- High shunt resistance, low dark current
- Customization available upon request

### Product Description

Excelitas is offering PIN Photodiodes for a broad wavelength spectrum from 400 nm to 1700 nm. Silicon PIN photodiodes are available in a wide variety of active areas to accommodate a large range of applications. The PIN structure allows high quantum efficiency and fast response for detection of photons in the 400 nm to 1100 nm range.

The YAG series offers an exceptional responsivity 0.4 A/W at 1060 nm by using a thick silicon material. Designed with a guard ring to collect current generated outside of the active area, they are the detectors of choice when the entire chip is illuminated by reducing unwanted carriers responsible for noise. Precise beam positioning can be achieved by using our quadrant detectors. The C30741 provides fast response and good quantum efficiency in the spectral range between 300 nm to 1100 nm. Designed for high-speed, high-volume production and cost-sensitive applications, these photodiodes are offered in plastic TO-style packages with a visible blocking filter option.

The InGaAs PIN detectors provide high quantum efficiency from 800 nm to 1700 nm. They feature low capacitance for extended bandwidth, high resistance for high sensitivity, high linearity, and uniformity within 2 % across the detector active area.

Product Table

### InGaAs PIN, High Speed, Peak Wavelength at 1550 nm

Unit	Active Diameter	Typ. @ 1550 nm Responsivity Peak	Typical Capacitance	Typical Bw	Dark Current	Breakdown Voltage	Operating Voltage	Package
	µm	A/W	pF	GHz	nA	V	V	
C30617BH	100	1.05	< 1.0	3.5	<1.0	100	5	TO-18, ball lens
C30617BFCH	100	1.05	< 1.0	3.5	<1.0	100	5	TO-18, FC receptacle
C30617BSCH	100	1.05	< 1.0	3.5	<1.0	100	5	TO-18, SC receptacle
C30617BQC-04-XX	100	1.05	< 1.0	3.5	<1.0	100	5	Pigtail or FC receptacle
C30617ECERH	100	1.05	< 1.0	3.5	<1.0	100	5	Ceramic carrier
C30617L-100	100	1.05	0.8	3.5	<1.0	100	5	SMT
C30617GH	100	1.05	<1.0	3.5	<1.0	100	5	TO-18
C30618BFCH	350	1.05	< 6.0	0.75	<1.0	80	5	TO-18, FC receptacle
C30618GH	350	1.05	< 6.0	0.75	<1.0	80	5	TO-18
C30618ECERH	350	1.05	< 6.0	0.75	<1.0	80	5	Ceramic carrier
C30618L-350	350	1.05	4.0	0.75	<1.0	80	5	SMT

## Product Table

## InGaAs PIN, Large Area, Peak Wavelength at 1550 nm

Unit	Active Diameter	Responsivity Peak	Capacitance (at 5V)	Shunt Resistance	B <sub>w</sub>	Dark Current	Breakdown Voltage	Package
	mm	A/W	pF	Mega Ohm	MHz	nA	V	
C30619GH	0.5	1.05	7	10	350	0.3	20	TO-18
C30619GH-LC	0.5	1.05	5	10	700	0.3	20	TO-18
C30619GH-TC	0.5	1.05	7	10	350	0.3	20	TO-8, flange, TE-cooled
C30619GH-DTC	0.5	1.05	7	10	350	0.3	20	TO-8, flange, dual TE
C30641EH-TC	1	1.05	22	5	350	1	20	TO-8, flange, TE-cooled
C30641EH-DTC	1	1.05	22	5	75	1	20	TO-8, flange, dual TE
C30641GH	1	1.05	22	5	75	1	20	TO-18
C30641GH-LC	1	1.05	18	5	150	1	20	TO-18
C30642GH-LC	1	1.05	77	2	40	2	15	TO-5
C30642GH-TC	1	1.05	90	2	20	2	15	TO-8, flange, TE-cooled
C30642GH-DTC	1	1.05	90	2	20	2	15	TO-8, flange, dual TE
C30642GH	2	1.05	90	2	20	2	15	TO-5
C30665GH	3	1.05	200	1	10	5	10	TO-5
C30665GH-LC	3	1.05	165	1	20	5	10	TO-5
C30665GH-TC	3	1.05	200	1	10	5	10	TO-8, flange, TE-cooled
C30665GH-DTC	3	1.05	200	1	10	5	10	TO-8, flange, dual TE
C30723GH	5	0.95	950	1	3	20	10	TO-8

## Product Table

## Silicon PIN

Unit	Active Diameter	Active Area	Responsivity Peak	Peak Wavelength	Capacitance	Rise Time	Dark Current	Shunt Resistance	Breakdown Voltage	Operating Voltage	Package
	mm	mm <sup>2</sup>	A/W	nm	pF	ns	nA	MΩ	V	V	
C30741PH-15S	1.5 x 1.5	2.25	0.47	800	11	2	0.05	-	300	10	Plastic T-1¾ through-hole
C30741PFH-15S	1.5 x 1.5	2.25	0.47	800	11	2	0.05	-	300	10	T-1¾ visible blocking
C30807EH	1	0.8	0.6	900	2.5	3	10	-	>100	45	TO-18
C30808EH	2.5	5	0.6	900	5	12	30	-	>100	45	TO-5
C30809EH	8	50	0.6	900	25	12	70	-	>100	45	TO-8
C30810EH	11	100	0.6	900	45	15	300	-	>100	45	TO-36
C30822EH	5	20	0.6	900	12	12	50	-	>100	45	TO-8
FND-100GH	2.5	5.1	0.64	920	8.5	<1	10	-	150	100	TO-5
FND-100QH	2.5	5.1	0.64	920	8.5	<1	10	-	150	100	TO-5, response down to 200 nm
YAG-100AH	2.5	5.1	0.7	1000	2.5	5	<20	-	>200	180	TO-5
YAG-200H	5	20	0.7	1000	6	5	<100	-	>200	180	TO-8
YAG-444AH	11.3	100	0.7	1000	35	5	<200	-	>200	180	Custom

## Product Table

## Specialty Silicon Detectors

Unit	Description	Active Diameter	Active Area	Capacitance	Rise/Fall Time	Dark Current	Breakdown Voltage min	Responsivity 900 nm	Responsivity 1060 nm	Noise Current	Package
		mm	mm <sup>2</sup>	pF	ns	nA	V	A/W	A/W	pA/√Hz	
C30845EH	900 nm Quadrant PIN	8	50	8	10	70	100	0.6	0.17	0.26	TO-8
YAG-444-4AH**	1064 nm Quadrant PIN	11.5	100	9	12	30	200	0.6	0.5	0.2	Custom
YAG-444N-4AH	1064 nm Quadrant PIN	11.5	100	9	12	30	200	0.6	0.5	0.1	Custom
YAG-555-4AH	1064 nm Quadrant PIN	14.1	156	12	12	50	200	0.6	0.5	0.2	Custom
YAG-555N-4AH	1064 nm Quadrant PIN	14.1	156	12	12	50	200	0.6	0.5	0.1	Custom
C30665GH-4	1550 nm Quadrant PIN	3	7	45	5	0.5	50	0.8	1.05	0.25	TO-5
C30665GH-4-LC	1550 nm Quadrant PIN	3	7	20	2	0.5	50	0.8	1.05	0.25	TO-5

\* Responsivity is measured at 900 and 1064 nm for 1064 nm quadrant PINs, and 1064 and 1550 nm for 1550 nm quadrant PINs.

\*\* The YAG series of quadrant PIN photodiodes are available with built-in heater package, upon request.

# PIN and APD Hybrid Receivers



## Si and InGaAs APD Modules

### Applications

- LiDAR
- Range finding
- Laser designation
- Confocal microscopy
- High-speed, extreme low-light detection
- Distributed Optical Fiber Sensing (DAS, DTS, DSS)
- Analytical instrumentation
- High-speed, free-space optical communication

### Features and Benefits

- Ultra low noise
- High speed
- High linear transimpedance gain
- Customization available upon request

### Product Description

These hybrid receivers comprise of a APD and a transimpedance amplifier in the same hermetically-sealed package. Having both amplifier and photodetector in the same package allows low noise pickup from the surrounding environment and reduces parasitic capacitances from interconnect allowing lower noise operation.

The C30659EH series includes an APD connected to a low noise transimpedance amplifier. Four models are offered with a Silicon APD and two models offered with an InGaAs APD. Standard bandwidth of 50 MHz and 200 MHz can accommodate a wide range of applications. The C30659 models are offered with the APD mounted on a thermo-electric cooler (the LLAM series) to help improve noise or to keep the APD at constant temperature regardless of the ambient temperature. The C30659EH can be customized to meet application specific requirements by using one of the Excelitas rear entry APDs, by choosing a custom bandwidth or by qualifying it to your environmental conditions. Pigtailed versions are also available in a 12 pins offering nearly 100% coupling efficiency. Both the C30659EH and LLAM series have options for enhanced higher damage thresholds, thus providing greater resilience when exposed to high optical power densities. The C30950EH offers a low cost alternative to the C30659EH. The amplifier is designed to neutralize the input capacitance of a unity voltage gain amplifier. The C30919E uses the same architecture of the C30950EH with the addition of a high voltage temperature compensation circuit which maintain module responsivity constant over a wide temperature range.

All optical receiver products can be qualified to meet the most demanding environmental specification as described in MIL-PRF-38534.

Figure 1

### APD Receiver Responsivity vs. Wavelength

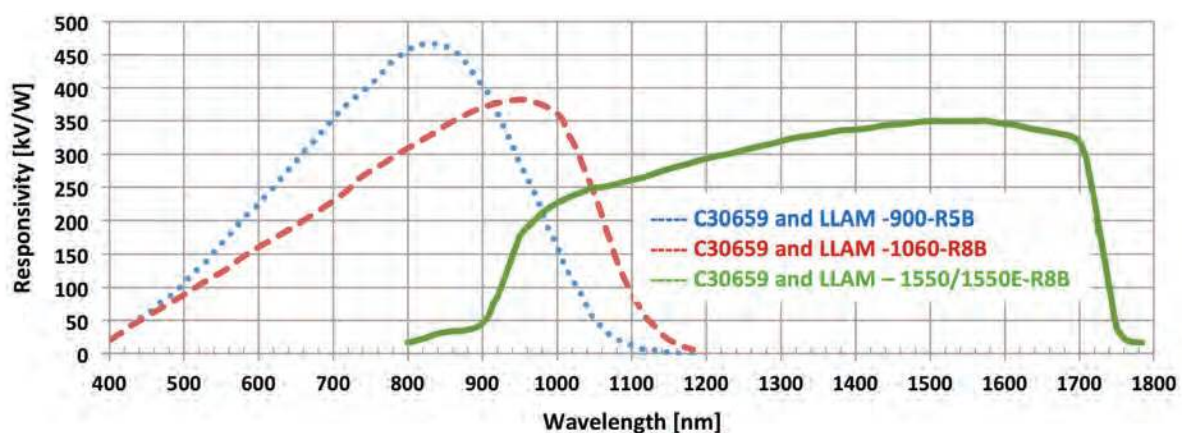



Product Table

Si and InGaAs APD Typical Modules

Unit	Detector	Active Diameter	Typical Bandwidth	Responsivity, 900 nm	Responsivity, 1064 nm	Responsivity, 1550 nm	NEP	Output Voltage Swing, 50 Ohm	Package
		mm	MHz	kV/W	kV/W	kV/W	fW/√Hz	V	
C30919E	C30817	0.8	40	1000	250	-	20	0.7	TO, 1 in
C30950EH	C30817	0.8	50	560	140	-	27	0.7	TO-8
C30659-900-R5BH	C30902	0.5	200	400	-	-	40	0.9	TO-8
C30659-900-R8AH	C30817	0.8	50	3000	-	-	12	0.9	TO-8
C30659-1060(E)-R8BH*	C30954	0.8	200	370	200	-	100	0.9	TO-8
C30659-1060-3AH	C30956	3.0	50	450	280	-	90	0.9	TO-8
C30659-1550(E)-R08BH*	C30645	0.08	200	-	-	90	220	0.9	TO-8
C30659-1550(E)-R2AH*	C30662	0.2	50	-	-	340	130	0.9	TO-8
LLAM-1550-R08BH	C30645	0.08	200	-	-	90	220	0.9	TO-8 FLANGE
LLAM-1550-R08BH*	C30645	0.08	200	-	-	90	220	0.9	TO-8 FLANGE
LLAM-1550-R2AH	C30662	0.2	50	-	-	340	130	0.9	TO-8 FLANGE
LLAM-900-R5BH	C30902	0.5	200	400	-	-	40	0.9	TO-8 FLANGE
LLAM-1550E-R2AH	C30662	0.2	50	-	-	340	130	0.9	TO-8 FLANGE
LLAM-1060-R8BH	C30954	0.8	200	370	200	-	50	0.9	TO-8 FLANGE
LLAM-1060E-R8BH*	C30954	0.8	200	370	200	-	50	0.9	TO-8 FLANGE
LLAM-1060-R8BH-FC	C30954	0.8	200	370	200	-	55	0.9	TO-8 FLANGE+FC

\* "E" versions of the receivers are with enhanced damage threshold over exposure protection feature.

Figure 1

TO-8 Package for C30659 Devices

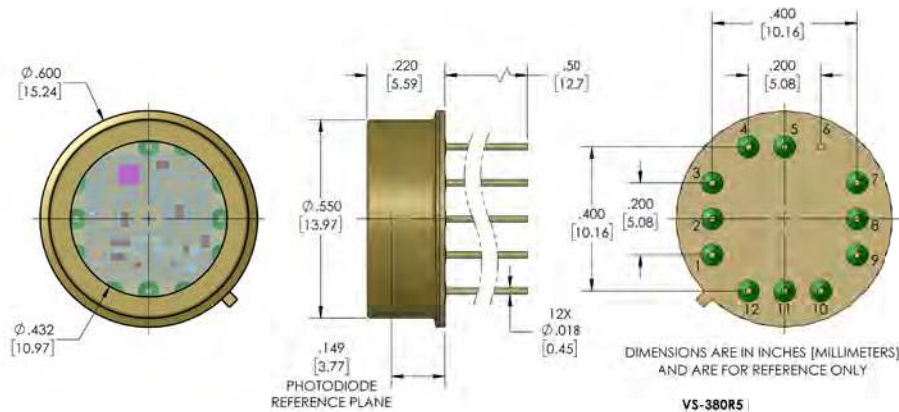
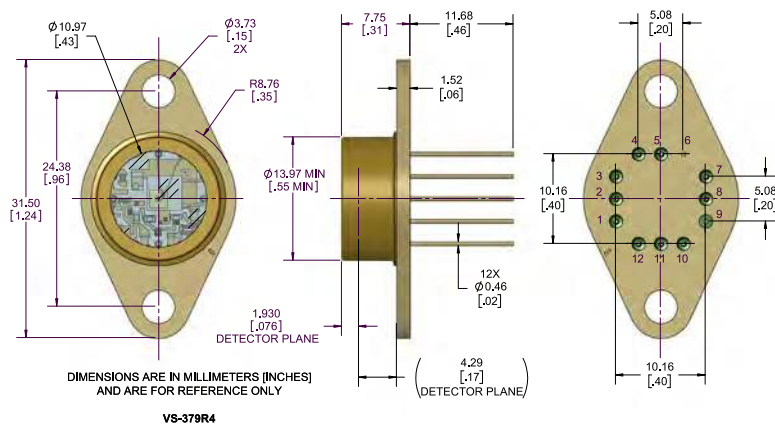

Figure 2

To Flange package for LLAM Devices



# Low Light Level (L<sup>3</sup>D) Detectors & Modules

LOW LIGHT LEVEL (L<sup>3</sup>D) DETECTORS & MODULES ■

Single Photon Counting Modules (SPCM)



## Single Photon Counting Modules – SPCM

### Applications

- Quantum Communication
- Particle sizing
- Confocal microscopy
- Photon correlation spectroscopy
- Quantum cryptography
- Astronomical observation
- Optical range finding
- Adaptive optics
- Ultra-sensitive fluorescence

### Features and Benefits

- Peak photon detection efficiency at 650 nm: 65%
- Active area: 180 μm diameter
- Gated output
- Single +5V supply
- FC receptacle option for fiber coupling
- Adapter brackets for cage or tube optical component holders available
- Fully RoHS compliant
- 4-channel array module available
- Customization available upon request

### Product Description

The SPCM-AQRH is a self-contained module that detects single photons of light over the 400 nm to 1100 nm wavelength range - a range and sensitivity that outperforms a photomultiplier tube. The SPCM-AQRH uses a unique silicon avalanche photodiode (SLIK) with a circular active area that achieves a peak photon detection efficiency of more than 65 % at 650 nm over a 180 μm diameter. The photodiode is both thermoelectrically cooled and temperature controlled, ensuring stabilized performance despite ambient temperature changes.

Count rates exceeding 35 million counts per second (Mc/s) are achieved by the SPCM-AQRH-WX module. There is a "dead time" of 24 ns between pulses.

As each photon is detected, a TTL pulse of 2.2 Volts (minimum) high into a 50 Ohm load and 10ns wide is output at the rear BNC connector. Other values for the dead time and pulse width are available as indicated on product data sheet.

The module is designed to give a linear performance at a case temperature between 5° C and 40° C.

The SPCM is also available in the following formats:

- 4 channel array SPCM-AQ4C,
- Timing resolution enhanced SPCM-AQRH-XX-TR,
- NIR optimized SPCM-NIR-XX.

Graph 1

### Characteristics SPCM Series

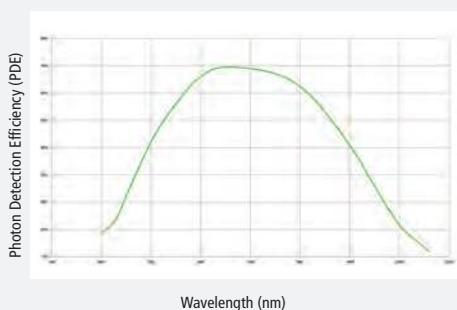

Product Table

### Single Photon Counting Modules – SPCM

Part Number	W - Output Pulse Options			X - Maximum Dark Count Rates (cps)						
	Output Pulse Width (ns)	Dead Time (ns)	Output Pulse Height (V)	-W0	-W1	-W2	-W3	-W4	-W5	-W6
SPCM-AQRH-WX										
-1X	10	24	2.2	1500	1000	500	250	100	50	25
-2X	18	28	2.2	1500	1000	500	250	100	50	25
-3X	28	42	2.2	1500	1000	500	250	100	50	25
-4X	10	24	4.4	1500	1000	500	250	100	50	25
-5X	18	28	4.4	1500	1000	500	250	100	50	25
-6X	28	42	4.4	1500	1000	500	250	100	50	25

Example: SPCM-AQRH-43 = 10ns output pulse width, 22ns dead time, 4.4V output pulse height, dark count < 250cps.

Figure 1

Mechanical Dimensions of the SPCM-AQRH Series

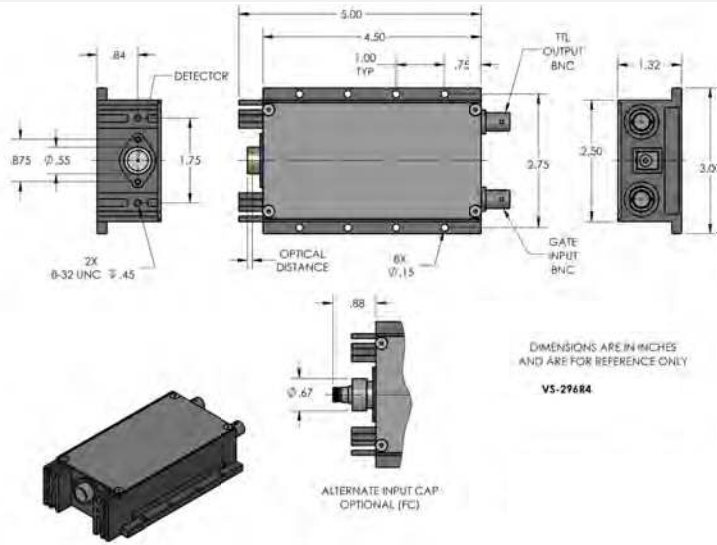

Figure 2

Mechanical Dimensions of the SPCM-AQ4C

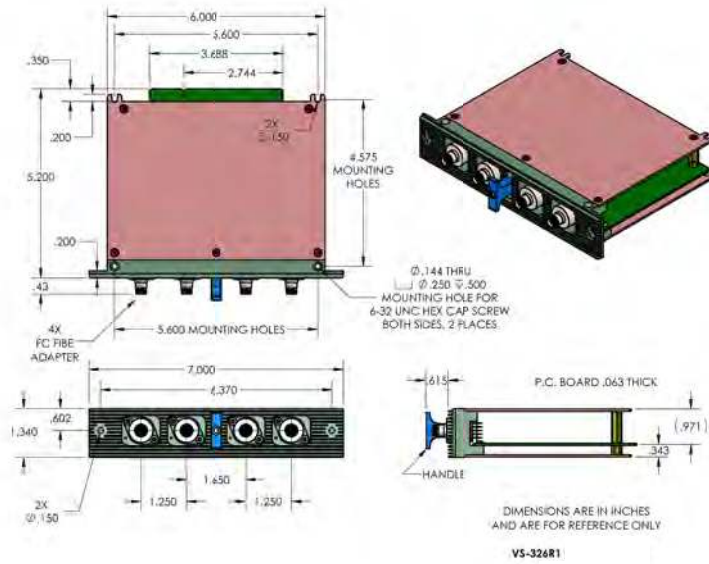
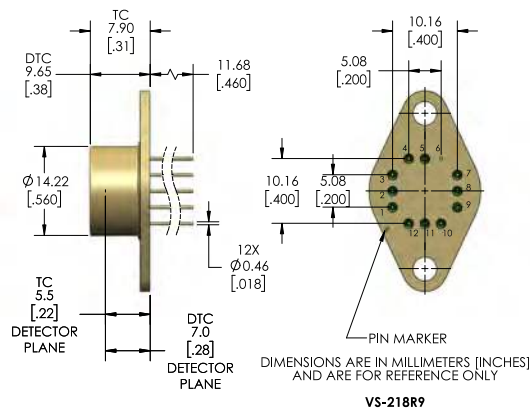

Figure 3

Package Drawing – TO-8 Flange



# Low Light Level (L<sup>3</sup>D) Detectors & Modules

## Coherent InGaAs PIN Balanced Receiver Module



### Applications

- Spectroscopy
- Optical delay measurement
- Heterodyne detection
- Optical coherent tomography
- Ellipsometry
- Ultra low signal detection

### Features and Benefits

- Spectral range: 800 nm -1700 nm
- 200 MHz bandwidth
- High performance InGaAs photodiode and TIA
- Matching responsivity
- Photo-current monitor outputs
- Rugged and robust
- RoHS compliant
- Enhanced EMC/EMI performance
- Customization available upon request

### Product Description

In the CIPRM-1 series balanced optical receiver Excelitas has the best features of high performance InGaAs photodiodes and low noise, high gain transimpedance amplifier to offer a practical solution to detect small changes above the interfering noise floor of incoming signal. The advantage is that the common optical noise is cancelled out.

This receiver incorporates two low-noise photodiodes with well-matched responsivity in order to ensure a high common mode rejection ratio (CMRR). It has two single mode fiber optic inputs, an RF output, one electrical input plug. The monitor outputs are within the RF output. The module is also available with two FC receptacle inputs and pigtail.

The CIPRM modules come in a robust casing with flange mounting holes for securing the module to working surfaces or platforms. Combined with a wide operating temperature range, the CIPRM can work in some of the toughest and harshest environments.

Product Table

### CIPRM-110 & CIPRM-210 MODULE

Parameter	Typical Specification	Notes
Wavelength Range	800-1700 nm	
Detector Material	InGaAs	
Detector Diameter	0.1 mm	
Detector Responsivity (Peak)	0.95 (A/W)	@1550 nm + fiber
Optical Input	FC/APC	9/125 with 900 μm buffer
Photo-current Monitoring Coefficient	2.85 V/mW	
Transimpedance Gain	32x10 <sup>3</sup> V/A	
Conversion Gain, Maximum	30x10 <sup>3</sup> V/W	
Integrated Noise	100 nW	NEP*√BW (at input)
Bandwidth (-3 dB)	2.5kHz -200MHz	
Rise Time	2ns	
Common Mode Rejection	30 dB	
NEP	7 pW/√Hz	
Overall Output Voltage Noise	3 mV	Measured
Output Impedance	50 Ω	
Saturation Optical Power CW	200 μW	CW unbalanced
Maximum Input Range	0.35 mW	Balanced, differential signal
Saturation Optical Power	10 mW	Balanced, max
Output Connector	SMA	
Maximum RF Power	+11dBm in 50Ω	
Power Requirements	±12V DC	Supply voltage
	I <sub>+12V</sub> = 32 mA	
	I <sub>-12V</sub> = 5 mA	Supply current

Figure 1

### CIPRM Module



# High Power Laser Diode

PULSED LASER DIODES ■

Pulsed Laser Diodes  
PGA – PGEW Series

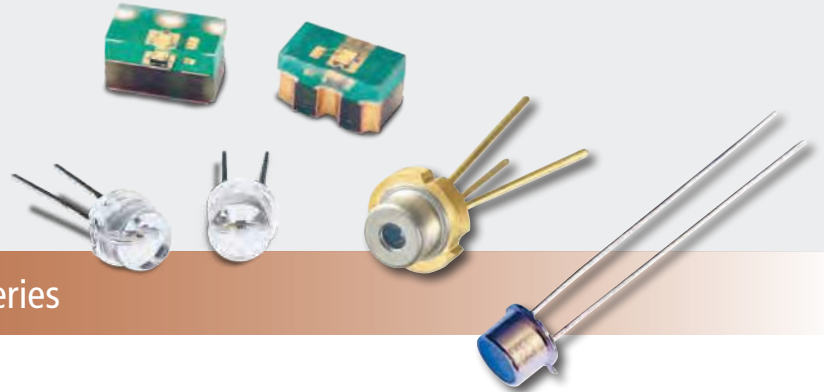

## Pulsed Laser Diodes – PGA – PGEW Series

### Applications

- LiDAR
- Range finders
- Safety light curtains
- Adaptive cruise control
- Autonomous vehicles
- Laser therapy

### Features and Benefits

- Multi-cavity lasers concentrate emitting source size
- Quantum well structure
- High peak pulsed power into aperture
- Excellent power stability with temperature
- Customization available upon request

### Product Description

Pulsed semiconductor lasers in the near IR are commonly used for long-distance time-of-flight or phase-shift range-finder or LiDAR systems. Excelitas offers a broad range of ideally-suited pulsed 905 nm laser designs including multi-cavity monolithic structures with up to 4 active areas per chip resulting in up to 100 W of peak optical output power. Physical stacking of laser chips is also possible, resulting in up to 300 W of peak optical output power.

Critical parameters are pulse-width and rise/fall times. The pulse width may be reduced allowing for increased current drive and resulting in higher peak optical power. Quantum-well laser design offers rise and fall times of <1ns but the drive circuit lay-out and package inductance play the greater role in determining rise/fall times, and should be designed accordingly. Excelitas offers a variety of package types with different inductance values to assist to this end.

Our core competencies include: MOCVD wafer growth; wafer processing of the grown GaAs wafers; assembly using either epoxy or solder die attach; epoxy encapsulation of lasers mounted on lead frame; hermetically-sealed product qualification to MIL STD and custom requirements.

### Product Table

PGA Pulsed Laser Family Selection Table, Typ. Wavelength 905 nm

Device (X = pkg)	Description		Emitting Area		Typical Peak Power at 10A, 100 ns	Typical Peak Power at 30A, 100 ns	Typical Temperature Coefficient nm / °C	Preferred Packages		
	# of Chips	Total # of Emitting Stripes	Width $\mu$ m	Height $\mu$ m	75 $\mu$ m (3 mils) Stripe Width	225 $\mu$ m (9 mils) Stripe Width		"S" Metal Can TO-18	"LU" High Volume Metal TO-56	"D" Epoxy Encapsulated SMT
TPG2EW1S09	1	3	225	10		85 W	0.25	plastic package		
PGAX1S03H	1	1	75	1	8 W		0.25	✓		✓
PGAX1S09H	1	1	225	1		25 W	0.25	✓		✓
DPGAX1S03H	1	2	75	5	16 W		0.25	✓	✓	✓
DPGAX1S09H	1	2	225	5		50 W	0.25	✓		✓
TPGAX1S03H	1	3	75	10	24 W		0.25	✓	✓	✓
TPGAX1S09H	1	3	225	10		75 W	0.25	✓	✓	✓
QPGAX1S03H	1	4	75	15	30 W		0.25	✓	✓	✓
QPGAX1S09H	1	4	225	15		100 W	0.25		✓	
TPGAX2S03H	2	6	75	175	48 W		0.25	✓		
TPGAX2S09H	2	6	225	175		150 W	0.25	✓		
QPGAX2S03H	2	8	75	225	60 W		0.25	✓		
QPGAX2S09H	2	8	225	225		200 W	0.25	✓		
QPGAX3S03H	3	12	75	450	90 W		0.25	✓		
QPGAX3S09H	3	12	225	450		300 W	0.25	✓		



Graph 1

Peak Radiant Intensity vs. Temperature

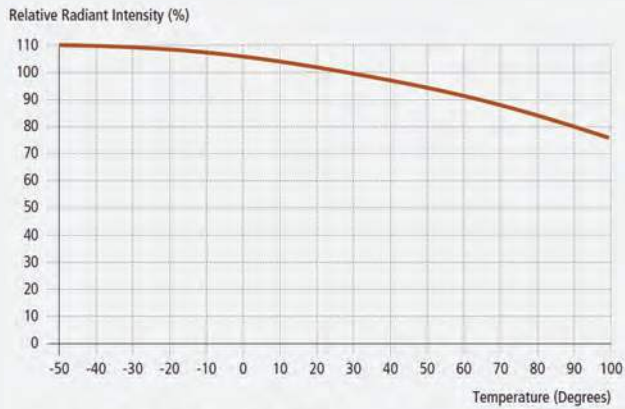

Graph 2

Spectral Plot Distribution

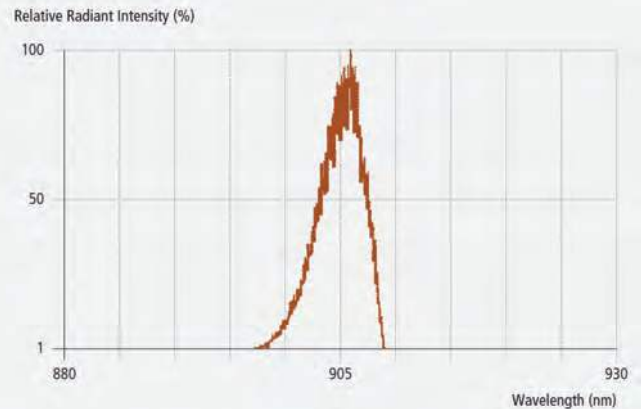

Graph 3

Center Wavelength vs. Temperature

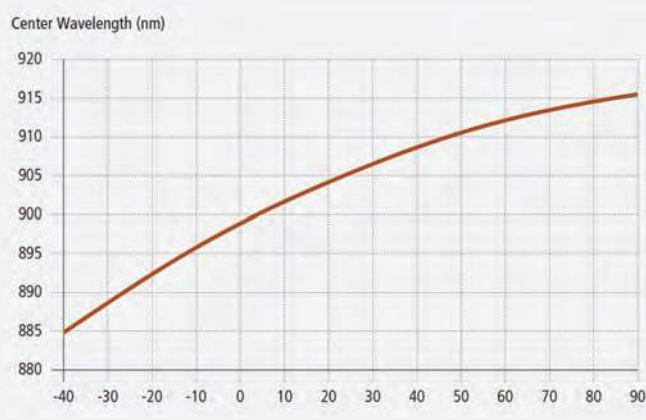
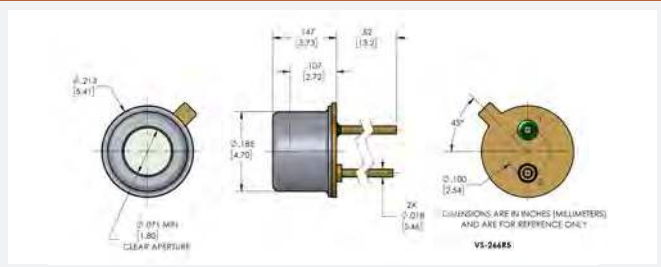

Figure 1

Package Drawing



Package S (TO-18)

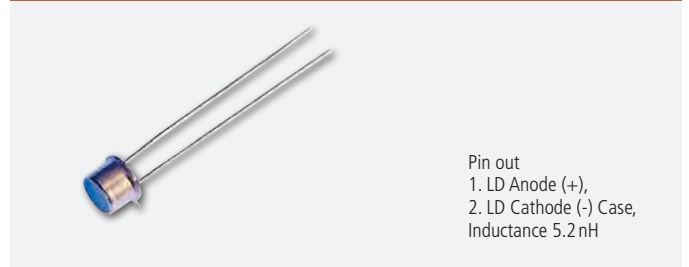
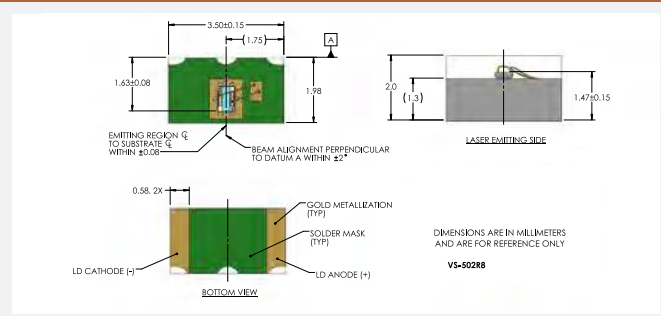

Figure 2

Package Drawing



Package D (Surface Mount)

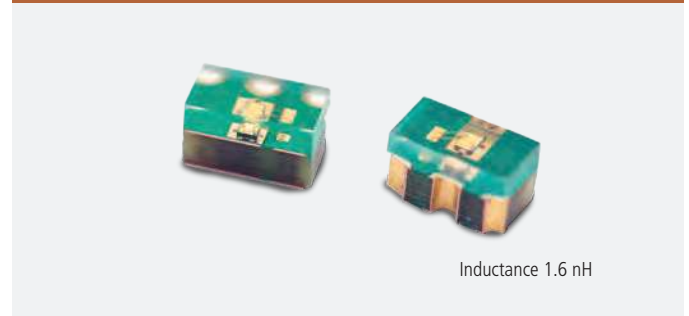

Figure 3

Package Drawing

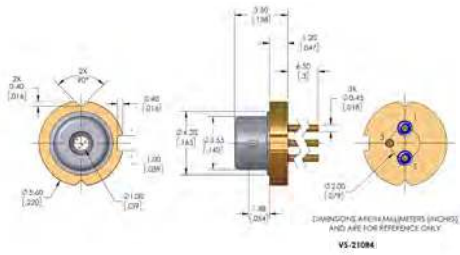

Figure 4

Housing / Package Drawing • Laser Chip on Board

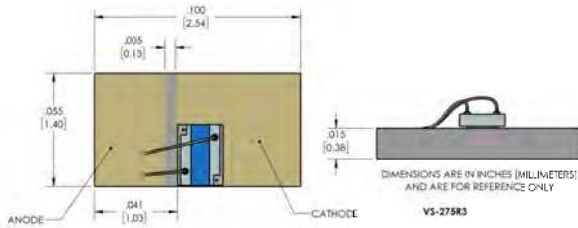

Figure 5

Package Drawing

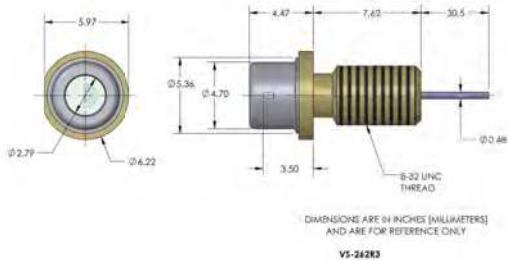

Figure 6

Package Drawing

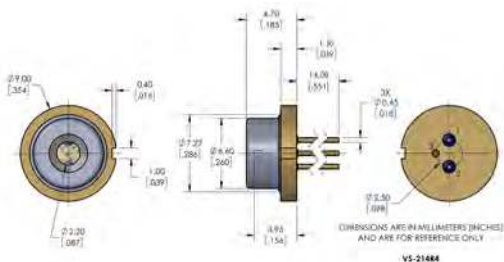
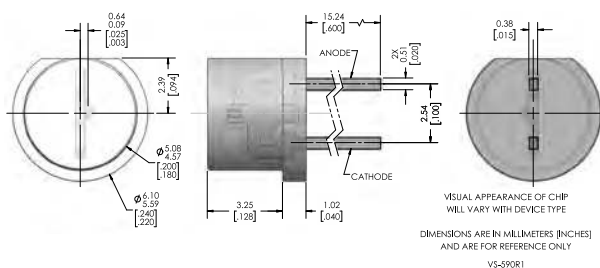

Figure 7

Housing / Package Drawing • TO-18-“W” Plastic Package (15 Devices Only)



Package U (5 mm CD)



- Pin out
1. LD Anode (+),
  2. NC,
  3. LD Cathode (-) Case, Inductance 5.0 nH

Package Y (Chip on Carrier)

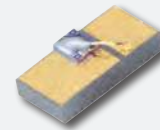

- Pin out
1. LD Cathode (-) chip bottom,
  2. LD Anode (+) chip top, Inductance 1.6 nH

Package C (8–32 Coax)



- Pin out
1. LD Anode (+),
  2. LD Cathode (-) Case, Inductance 12 nH

Package R (9 mm CD)

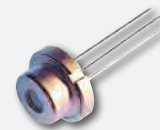

- Pin out
1. LD Anode (+),
  2. NC,
  3. LD Cathode (-) Case, Inductance 6.8 nH

Package W (TO-18 Plastic)



- Pin out
1. (Pkg Flat) LD Anode (+),
  2. LD Cathode (-), Inductance 5.0 nH

# Smoke Detection Modules & Components

## SMOKE DETECTION MODULES ■

OpticBlocks™, Chambers, and Components



## OpticBlocks™, Chambers and Components

### Applications

- Electro-optical smoke detection

### Features and Benefits

- Complete Smoke Sensor with the OpticBlock plus Smoke Chamber with Mesh
- Precise component positioning for the OpticBlock
- 100% tested transfer function that is correlated to smoke sensitivity
- OpticBlock reflow solderable
- Smoke Chambers can be snapped onto PCB or the OpticBlock
- High quality components: Photodiodes, IREDS, and Blue LEDs (both emitters UL-listed)

### Product Description

A complete electro-optical smoke detector module consists of an emitter (IRED or Blue LED) and Photodiode (PD) in a defined optical arrangement (OpticBlock) that detects scattered optical signal when smoke flows inside a Smoke Chamber. Signal range in the presence and absence of smoke (clean-air condition) and their long term stability are key features of a smoke detector module. The OpticBlock transfer function, i.e. the signal received at the PD under a test that simulates presence of smoke, is set to a specific range which helps to narrow and stabilize the smoke sensitivity range and the detection threshold. The Smoke Chambers are designed such that clean-air signals are kept to a minimum, enabling high signal-to-background ratio. The emitters (IRED or Blue LED) are all UL-certified for Smoke Detection, and together with legacy and time-tested photodiodes, a reliable smoke detection solution is realized. The OpticBlock and Smoke Chambers are produced in high volumes. Excelitas can offer customization if you want custom design for your smoke detection product. Please contact Excelitas to discuss your requirements.

Product Table

### Selected Photodiodes Used in Smoke Detection Applications

Symbol Unit	Package	Active Area (mm <sup>2</sup> ) mm	Minimum Short Circuit	Maximum Dark	Maximum Junction Capacitance (pF)	Radiometric Sensitivity @ $\lambda_P$	Spectral Range $\lambda_{RANGE}$ nm	Peak Wavelength $\lambda_P$ nm	Noise Equivalent Power
			Current @ 100fc, 2850K $\mu A$	Current @ VR = 10V nA		typ $S_R$ A/W			typ NEP W/Hz
VTP1188SH	Lensed Ceramic	11	200 (Typical)	30 @ $V_R = 10mV$	300 @ $V_R = 0V$	0.55	400-1100	925	-
VTP1232H	T-1 3/4 lensed	2.326	100	25	100 @ $V_R = 0V$	0.6	400-1100	920	-
VTP3410LAH	T-1 lensed IRT	0.684	15	35 @ $V_R = 50V$	25 @ $V_R = 3V$	0.55	700-1150	925	1.9 X 10-13
VTP3420LA	T-1 lensed IRT	1.64	34	35	150 @ $V_R = 15V$	0.55	700-1150	925	-
VTP3430LA	T-1 lensed IRT	1.64	41	35	150 @ $V_R = 15V$	0.55	400-1150	925	-

Product Table

### Selected LEDs (IREDS and Blue LED) Used in Smoke Detection Applications

Symbol Unit	Package	Typical Total Power (mW)	Typical Irradiance (mW/cm <sup>2</sup> )	Test Current/ Pulsed (mA)	Typical	Wavelength (nm)	Half
					Forward Voltage Drop (V)		Power Beam Angle
VTE1291-1H	T-1 3/4 lensed	20	3.3 <sup>(1)</sup>	100	1.5	880	±12°
VTE1291-2H	T-1 3/4 lensed	25	6.5 <sup>(1)</sup>	100	1.5	880	±12°
VTE1295H	T-1 3/4 lensed BULLET	20	5.5 <sup>(1)</sup>	100	1.5	880	±8°
VTE3374LAH	T-1 lensed	5	5.2 <sup>(2)</sup>	20	1.3	880	±10°
VTE3375LA	T-1 lensed	3	2 <sup>(2)</sup> (Min.)	20	1.3	880	±12.5°
VTE3310	T-1 lensed	1	0.5 <sup>(2)</sup> (Min.)	20	3.2	460	±5°

(1): Tested at 36mm on a 6.4mm diameter.

(2): Tested at 10.16mm on a 2.1mm diameter.

Product Table

OpticBlock™ (21R103 and 21R104) Performance Characteristics

Parameters	Symbol	IR OpticBlock™ 21R104				Blue OpticBlock™ 21R103				Units
		Min	Typ	Max	Test Conditions	Min	Typ	Max	Test Conditions	
Storage Temperature		-30		65		-30		65		°C
Operation Temperature		-30		65		-30		65		°C
LED Peak Wavelength	$\lambda_p$		880		At 25°C		460		At 25°C	nm
LED Forward Voltage	$V_F$			2.3	$I_{FC} = 50\text{mA}$	2.7		3.7	$I_F = 20\text{mA}$	V
LED Continuous Current	$I_{FC}$			50	At 25°C			50	At 25°C	mA
LED Peak Forward Current	$I_{FP}$			0.25	250 $\mu\text{s}$ , 6.32 Hz			100	1/10 duty cycle at 1kHz	A
PD Forward Voltage	$V_{F,PD}$			1.5	At 0fc, $I_{F,PD} = 10\text{mA}$			1.5	At 0fc, $I_{F,PD} = 10\text{mA}$	V
PD sensitivity range		700		1150		400		1150		nm
PD Capacitance	$C_{PD}$			150	At -15V bias			150	At -15V bias	pF

The IRED is UL approved under File S3506 for the use in electro-optical smoke detectors.  
 The Blue LED is UL approved under File S3506 for the use in electro-optical smoke detectors.

Figure 1

OpticBlock™ (21R103 and 21R104) Dimensions (in mm)



Figure 2

PCB snap-on Smoke Chamber 21R096 (in mm)

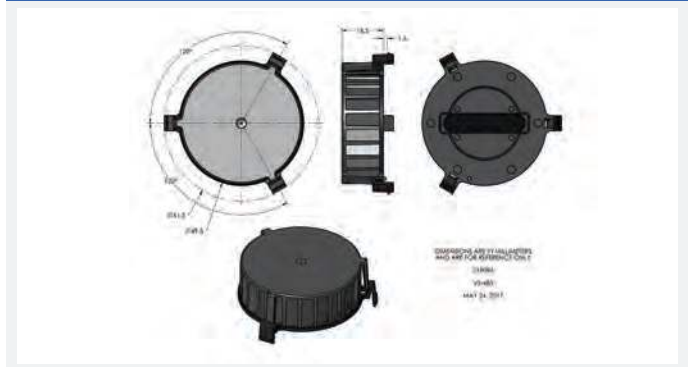
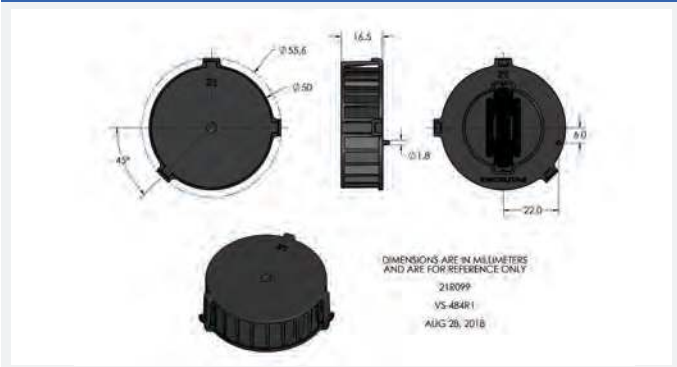

Figure 3

OpticBlock™ snap-on Smoke Chamber 21R099 (in mm)



Product Table

OpticBlock™ and Smoke Chamber

Part Number	Package
21R104TR	OpticBlock™ (IR wavelength) in Tape and Reel
21R103TR	OpticBlock™ (Blue wavelength) in Tape and Reel
21R096	Smoke Chamber (PCB snap-on)
21R096-1	Smoke Chamber (PCB snap-on) with Metal Mesh
21R099	Smoke Chamber (OpticBlock™ snap-on)
21R099-1	Smoke Chamber (OpticBlock™ snap-on) with Metal Mesh

# Application Specific Components

## PHOTODIODES & -TRANSISTORS FOR HIGH-VOLUME APPLICATIONS ■

Left: Spectrally Adapted Photodiodes and Phototransistors  
T-1 3/4 (TO-like) Through-Hole Package (4.9 mm Diameter)

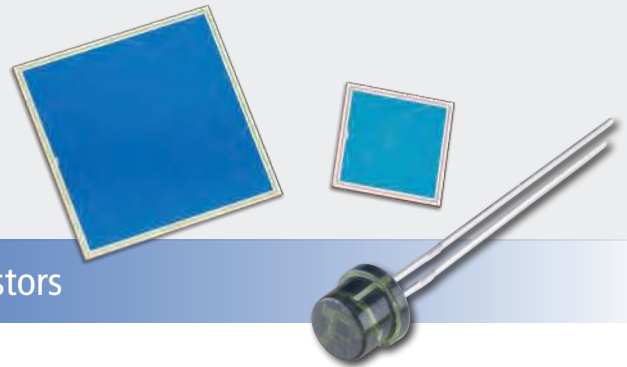

## Spectrally Adapted Photodiodes and Phototransistors

### Applications

- Interior and exterior light switching (dusk/dawn switch)
- Interior and exterior light control (dimming)
- Automotive headlight dimmer
- Display contrast control
- Energy conservation

### Features and Benefits

- Response approaching human eye using Excelitas' IR-BLOC™ technology
- Perfect light sensor in conjunction with Excelitas' pyroelectric detectors for motion controlled light switches
- RoHS compliant
- Selectable wavelength detection range
- Small footprint

### Product Description

Ambient light sensors from Excelitas provide an easy solution for applications that require a response similar to the human eye, making it ideal when the response should only be influenced by visible light. These devices contribute in various applications to energy conservation in both fixed and portable devices.

Product Table

### Spectrally Adapted Photodiodes and Phototransistors

Symbol	Package	Active Area mm <sup>2</sup>	Min. Short Circuit Current @ H=100fc, 2850K		Maximum Dark Current (nA)	Maximum Junction Capacitance (nF)	Typical Radio-metric Sensitivity @ λ <sub>p</sub>	Spectral Range λ <sub>RANGE</sub>	Typical Peak Wave-length λ <sub>p</sub>	Typical Noise Equivalent Power W <sub>i</sub> /Hz
			min	I <sub>sc</sub> μA						
Unit							A/W	nm	nm	
VTP9812FH	T-1 3/4 flat	1.548	0.7	10 @ V <sub>R</sub> = 10V	0.15 @ V <sub>R</sub> = 10V	0.034	400-700	580	-	
VTB1012BH	TO-46	1.6	0.8	0.1 @ V <sub>R</sub> = 2V	0.31 @ V <sub>R</sub> = 0V	0.3	330-720	580	5.3 X 10 <sup>-14</sup>	
VTB1013BH	TO-46	1.6	0.8	0.02 @ V <sub>R</sub> = 2V	0.31 @ V <sub>R</sub> = 0V	0.3	330-720	580	1.1 X 10 <sup>-14</sup>	
VTB6061CIEH	TO-8	37.7	-	2 @ V <sub>R</sub> = 2V	11 @ V <sub>R</sub> = 0V	-	460-675	555	1.3 X 10 <sup>-13</sup>	
VTT9812FH	T-1 3/4 flat	0.191	60	50 @ V <sub>CE</sub> = 5V	-	7	450-700	585	-	
VTT9814FH	T-1 3/4 flat	0.191	80 (min) 120 (max)	50 @ V <sub>CE</sub> = 5V	-	7	450-700	585	-	

Electrical characteristics at T<sub>Ambient</sub> = 25 °C

### Product Description

The VTH21xx series photodiodes have a large active area and low capacitance and are specifically designed for alpha particle detection. They are available in bare chips to suit the alpha particle / radon detection, shipped in wafer pack. Custom packages are available as options.

Product Table

### Large Area Photodiodes for Alpha Particle / Radon Detection

Part Number	Package	Active Size (mm)	Active Area (mm)	Dark Current Maximum (nA)	Junction Capacitance Maximum (pF)
VTH2110	Bare chip	5 x 5	25	2nA @ Vr=20V	30pF @ Vr=20V
VTH2120	Bare chip	10 x 10	100	5nA @ Vr=20V	120pF @ Vr=20V



# Photodiode Arrays

## SILICON PHOTODIODE ARRAYS ■

Left: 16 Element, 1.6 mm Pitch  
Photodiode Array With Segmented  
Csi Scintillator

Right: 16 Element, 2.5 mm Pitch  
Photodiode Array With GOS Low  
Energy Screen Scintillator

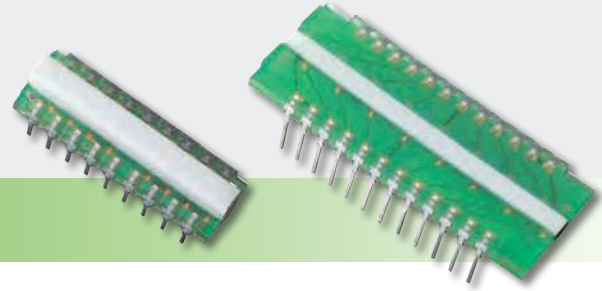

## Photodiode Arrays – VTA Series

### Applications

- Luggage scanning
- Cargo & container scanning
- Food inspection
- Non-destructive testing

### Features and Benefits

- Various crystal types available (Csl, GOS, etc.)
- Custom chip geometry & pitch
- Single or dual-sided assemblies
- High responsivity and low capacitance
- Onboard electronics available on a custom basis
- Multiple photodiode rows

### Product Description

These photodiode arrays are used to generate an X-ray image by scanning an object line by line. The X-rays are converted into light through the attached scintillator crystal. The light intensity is then measured by the photodiodes. The boards are employing chip-on-board technology with optically adapted scintillator crystals. The listed designs can be ordered as a standard part, but can also be customized to meet the needs of a wide variety of applications. Excelitas custom photodiode arrays give customers the option to choose the:

- active photodiode area
- total number of elements
- overall PCB and photodiode chip dimensions
- photodiode chip geometry and orientation
- electro-optical specifications
- single sided vs. double sided PCB
- alternative substrate materials (e.g. ceramic)
- electrical interface (e.g. connector)

Product Table

### Photodiode Arrays • VTA Series

Symbol	Substrate		Active Area	Photodiode Chip Dimensions		Pitch	Number of Elements	Scintillator Crystal Type	Light Current Uniformity @ 540 nm, 30 nW/cm <sup>2</sup>	Dark Current @ H = 0, VR = 10 mV		Junction Capacitance @ H = 0, VR = 0V		Radiometric Sensitivity @ 540 nm
	Material	Dimensions		Design	Design					typ	max	typ	max	min
			mm <sup>2</sup>			mm	mm	mm						
Unit		mm		mm	mm	mm	Elements	Crystal Type	%	pA	pA	pF	pF	A/W
<b>VTA2164H-D-NC-00-0</b>	FR4	43.2x67.7	1.41	1.40x3.50	2.1	64	Custom	±5	<10	90	<100	200	0.30	
<b>VTA1616H-H-SC-01-0</b>	FR4	8.0x25.4	2.58	1.51x3.25	1.6	16	Csl	±5	-	50	-	350	0.30	
<b>VTA1616H-L-SC-02-0</b>	FR4	16.0x25.4	2.58	1.51x3.25	1.6	16	GOS	±5	-	50	-	350	0.30	
<b>VTA2516H-H-SC-01-0</b>	FR4	8.0x40.0	5.20	2.45x3.15	2.5	16	Csl	±5	-	50	-	600	0.30	
<b>VTA2516H-L-SC-02-0</b>	FR4	16.0x40.0	5.20	2.45x3.15	2.5	16	GOS	±5	-	50	-	600	0.30	
<b>VTA1216H-H-NC-00-0</b>	FR4	10.2x19.0	3.44	2.30x4.95 (dual cell)	1.2	16	Custom	±5	-	100	-	300	0.30	
<b>VTA1216H-L-NC-00-0</b>	FR4	17.8x19.0	3.44	2.30x4.95 (dual cell)	1.2	16	Custom	±5	-	100	-	300	0.30	
<b>VTA0832H-H-NC-00-0</b>	FR4	17.8x25.4	0.50	1.59x2.34 (dual cell)	0.8	32	Custom	±5	-	100	-	100	0.30	

Electrical characteristics at T<sub>Ambient</sub> = 25 °C

Figure 1

Side 1 Detail VTA2164H-D

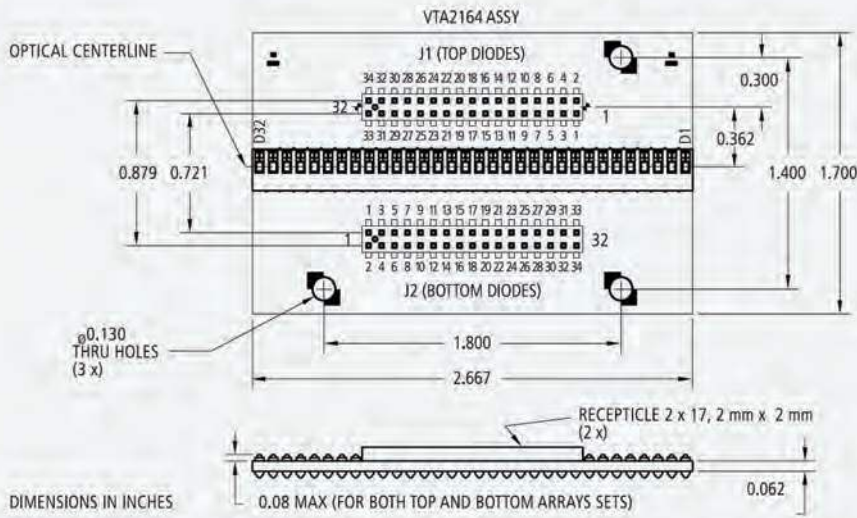

Figure 2

Side 2 Detail VTA2164H-D

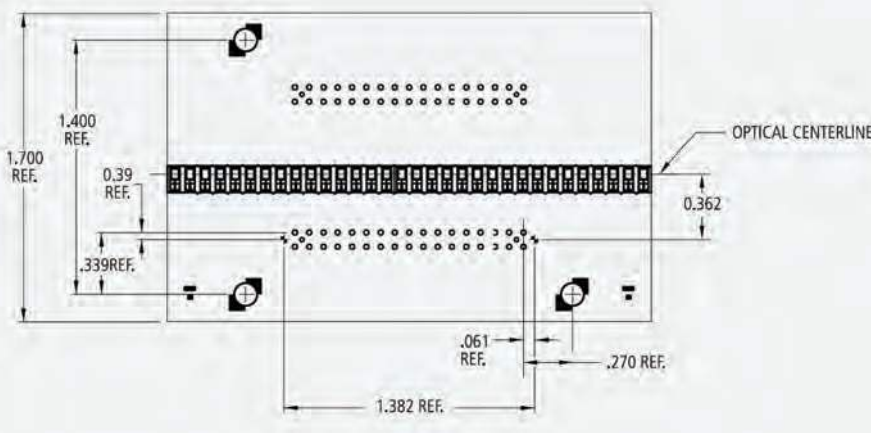
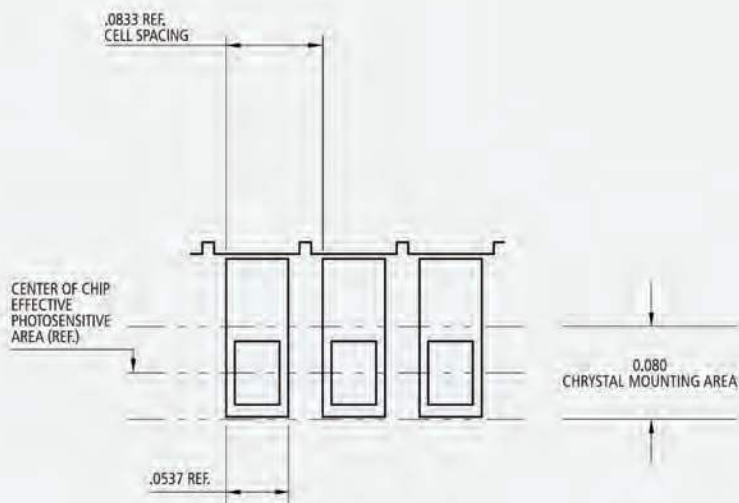

Figure 3

Chip Spacing Details, Side 1 (Typ.) VTA2164H-D

Photosensitive Area 0.0545" x 0.0385 (Typ.) or 0.0021 SQ. IN.



SILICON PHOTODIODE ARRAYS

Pin Out VTA2164H-D

Connector J1 (Top Diodes)		Connector J2 (Bottom Diodes)	
Pin	Connection	Pin	Connection
1	D1	1	D1
2	D2	2	D2
3	D3	3	D3
4	D4	4	D4
5	D5	5	D5
6	D6	6	D6
7	D7	7	D7
8	D8	8	D8
9	D9	9	D9
10	D10	10	D10
11	D11	11	D11
12	D12	12	D12
13	D13	13	D13
14	D14	14	D14
15	D15	15	D15
16	D16	16	D16
17	D17	17	D17
18	D18	18	D18
19	D19	19	D19
20	D20	20	D20
21	D21	21	D21
22	D22	22	D22
23	D23	23	D23
24	D24	24	D24
25	D25	25	D25
26	D26	26	D26
27	D27	27	D27
28	D28	28	D28
29	D29	29	D29
30	D30	30	D30
31	D31	31	D31
32	D32	32	D32
33	N/C	33	N/C
34	Common	34	Common

Figure 4

Pos. of Top Diodes Rel. to Bottom Diodes VTA2164H-D

(Optical Center Line to Optical Center Line)

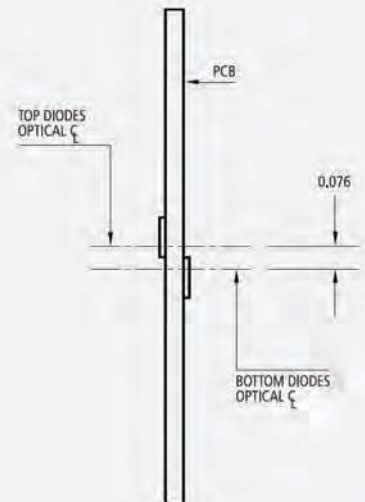

# Blue-Enhanced Silicon Photodiodes

## SILICON PN PHOTODIODES ■

Silicon Photodiodes – VTB Series  
Ultra High Dark Resistance

## Silicon Photodiodes – VTB Series – Ultra High Dark Resistance

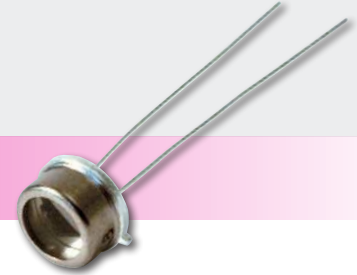

### Applications

- Ambient light sensing
- UV and blue light sensing
- Flame monitoring
- Light meters
- Photometry

### Features and Benefits

- UV to IR spectral range
- Integral IR rejection filters available
- Response @ 365 nm, 0.14A/W typical
- Response @ 220 nm, 0.06A/W typical with UV window
- 1 to 2 % linearity over 7 to 9 decades
- Very low dark current
- High shunt resistance
- RoHs compliant

### Product Description

This series of P on N silicon planar photodiodes have been designed for optimum response through the visible part of the spectrum. Units with UV transmitting windows also exhibit excellent response in the UV. "B" series units have a built-in infrared rejection filter for applications requiring a response approximating the human eye. Photodiodes made with the VTB process are primarily intended to be used in photovoltaic mode but may be used with a small reverse bias. All photodiodes in this series exhibit very high shunt resistance. This characteristic leads to very low offsets when used in high gain transimpedance op-amps circuits.

#### VTB1012



Small area planar silicon photodiode in flat window TO-46 package

#### VTB6061



Large area planar silicon photodiode in a flat window TO-8 package

#### VTB4051



Planar silicon photodiode mounted on a ceramic substrate and coated with a layer of clear epoxy

#### VTB8341



Planar silicon photodiode mounted on a ceramic substrate and coated with a layer of clear epoxy

Product Table

Silicon Photodiodes – VTB Series – Ultra High Dark Resistance

Symbol	Unit	Package	Active Area (mm <sup>2</sup> )	Short Circuit Current @ 100 fc, 2850 K		Typical Junction Capacitance @ VR = 0V (nF)	Typical Radiometric Sensitivity @ λ <sub>peak</sub> (A/W)	Spectral Range (nm)	Typical Peak Wavelength (nm)	Typical Noise	
				min I <sub>sc</sub> μA	max I <sub>d</sub> VR = 2V (nA)					Equivalent Power W/√Hz	
<b>VTB100AH</b>		Flat sidelooper	7.1	50	0.5 @VR = 10V	2	0.55	320-1100	925	9 X 10 <sup>-14</sup>	
<b>VTB1012H</b>		TO-46	1.6	8	0.1	0.31	0.5	320-1100	920	3 X 10 <sup>-14</sup>	
<b>VTB1012BH</b>		TO-46	1.6	0.8	0.1	0.31	0.29	330-720	580	5.3 X 10 <sup>-14</sup>	
<b>VTB1013H</b>		TO-46	1.6	8	0.02	0.31	0.5	320-1100	920	5.9 X 10 <sup>-15</sup>	
<b>VTB1013BH</b>		TO-46	1.6	0.8	0.02	0.31	0.29	330-720	580	1.1 X 10 <sup>-14</sup>	
<b>VTB1112H</b>		TO-46 lensed	1.6	30	0.1	0.31	0.5	320-1100	920	3 X 10 <sup>-14</sup>	
<b>VTB1112BH</b>		TO-46 lensed	1.6	3	0.1	0.31	0.29	330-720	580	5.3 X 10 <sup>-14</sup>	
<b>VTB1113H</b>		TO-46 lensed	1.6	30	0.02	0.31	0.5	320-1100	920	5.9 X 10 <sup>-15</sup>	
<b>VTB1113BH</b>		TO-46 lensed	1.6	3	0.02	0.31	0.29	330-720	580	1.1 X 10 <sup>-14</sup>	
<b>VTB4051H</b>		Ceramic	14.8	100	0.25	3	0.5	320-1100	920	2.1 X 10 <sup>-14</sup>	
<b>VTB5051H</b>		TO-5	14.8	85	0.25	3	0.5	320-1100	920	2.1 X 10 <sup>-14</sup>	
<b>VTB5051BH</b>		TO-5	14.8	8	0.25	3	0.29	330-720	580	3.7 X 10 <sup>-14</sup>	
<b>VTB5051JH</b>		TO-5 with 3 pins	14.8	85	0.25	3	0.5	320-1100	920	2.1 X 10 <sup>-14</sup>	
<b>VTB5051UVH</b>		TO-5	14.8	85	0.25	3	0.1 @ 365 nm	200-1100	920	2.1 X 10 <sup>-14</sup>	
<b>VTB5051UVJH</b>		TO-5 with 3 pins	14.8	85	0.25	3	0.1 @ 365 nm	200-1100	920	2.1 X 10 <sup>-14</sup>	
<b>VTB6061H</b>		TO-8	37.7	260	2	8	0.5	320-1100	920	5.7 X 10 <sup>-14</sup>	
<b>VTB6061BH</b>		TO-8	37.7	26	2	8	0.29	330-720	580	1 X 10 <sup>-13</sup>	
<b>VTB6061CIEH</b>		TO-8	37.7		2	8		460-675	555	1.3 X 10 <sup>-13</sup>	
<b>VTB6061JH</b>		TO-8 with 3 pins	37.7	260	2	8	0.5	320-1100	920	5.7 X 10 <sup>-14</sup>	
<b>VTB6061UVH</b>		TO-8	37.7	260	2	8	0.1 @ 365 nm	200-1100	920	5.7 X 10 <sup>-14</sup>	
<b>VTB6061UVJH</b>		TO-8 with 3 pins	37.7	260	2	8	0.1 @ 365 nm	200-1100	920	5.7 X 10 <sup>-14</sup>	

Figure 1

Package Drawing – VTB Series – Flat Sidelooper Package

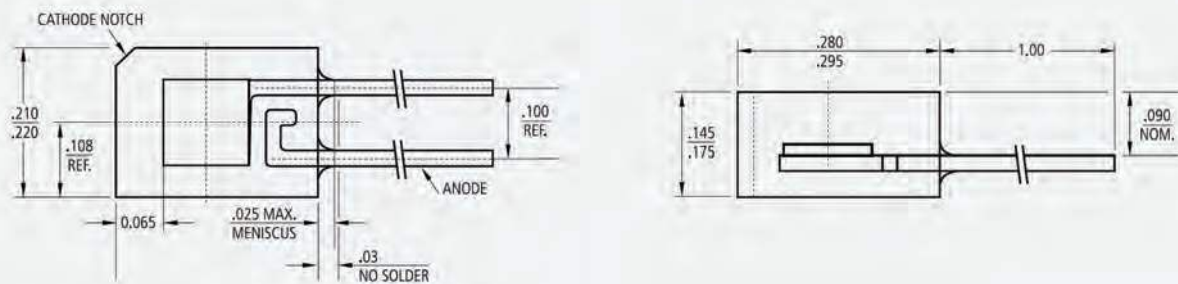

Figure 2

Package Drawing – VTB Series – TO-46 Package

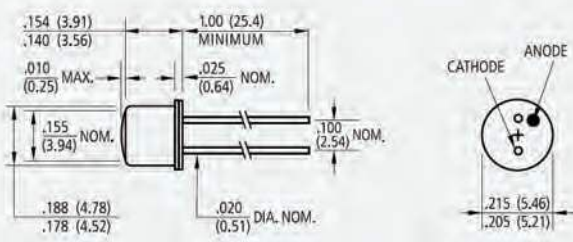

Figure 3

Package Drawing – VTB Series – TO-5 Package

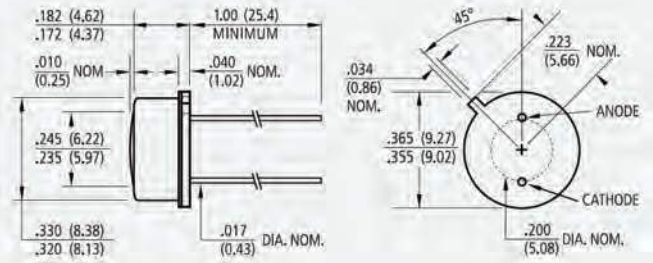

Figure 4

Package Drawing – VTB Series - TO-46 Lensed

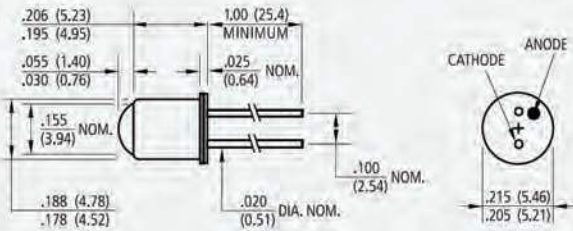

Figure 5

Package Drawing – VTB Series - Ceramic Package

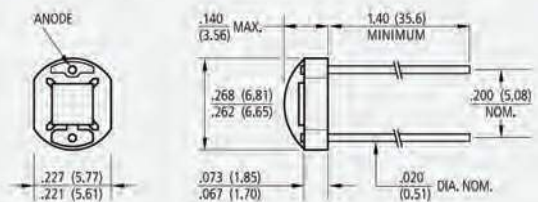

Figure 6

Package Drawing – VTB Series- 8mm Ceramic Package

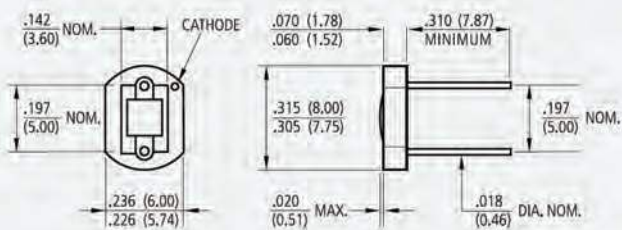
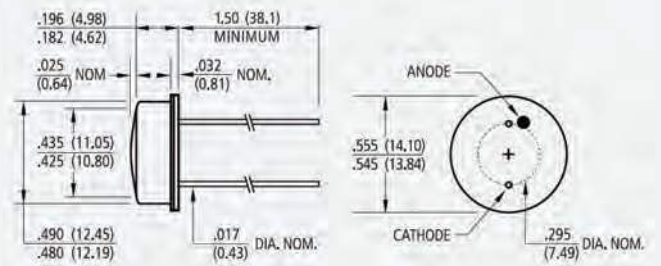

Figure 7

Package Drawing – VTB Series – TO-8 Package





Graph 1

Absolute Spectral Response

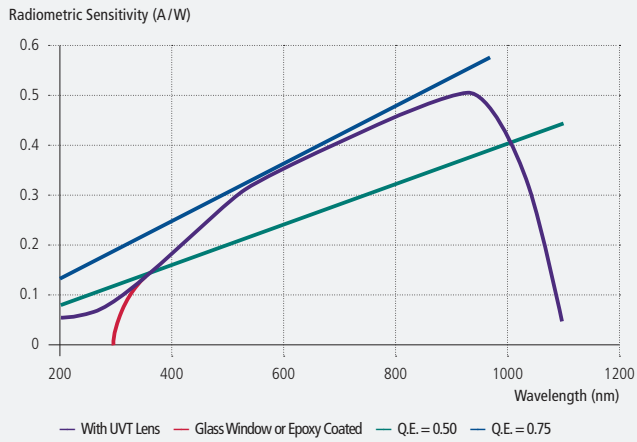

Graph 2

Absolute Spectral Response "B" Series (Filtered)

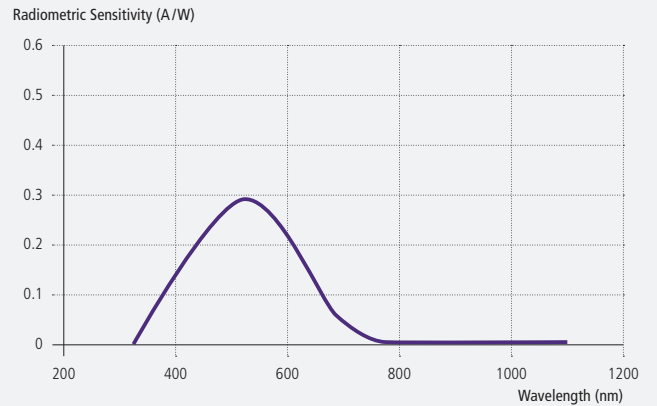

Graph 3

Rel. Current or Resistance vs. Temperature (Referred to 25°C)

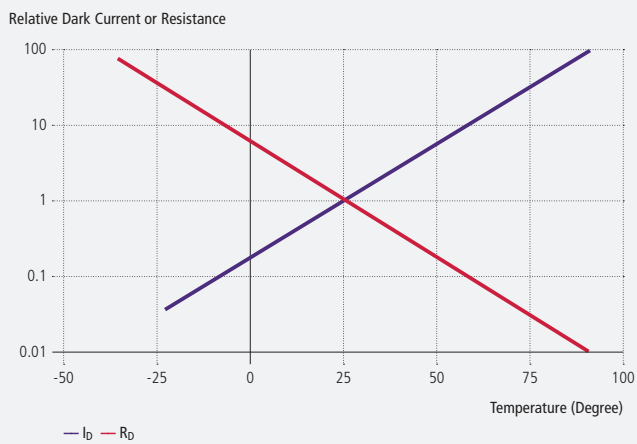

Graph 4

Relative Junction Capacitance vs. Voltage (Referred to Zero Bias)

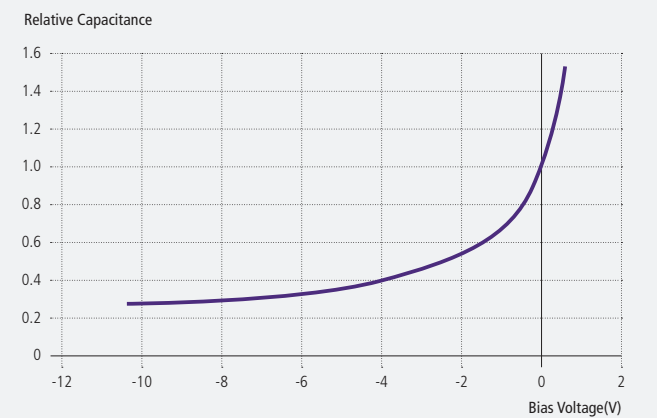

Graph 5

Relative Short Circuit Current vs. Illumination

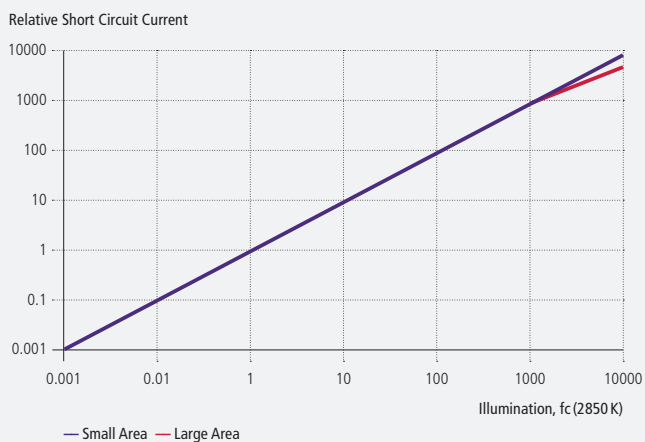

Graph 6

Rise/Fall Times – Non Standard

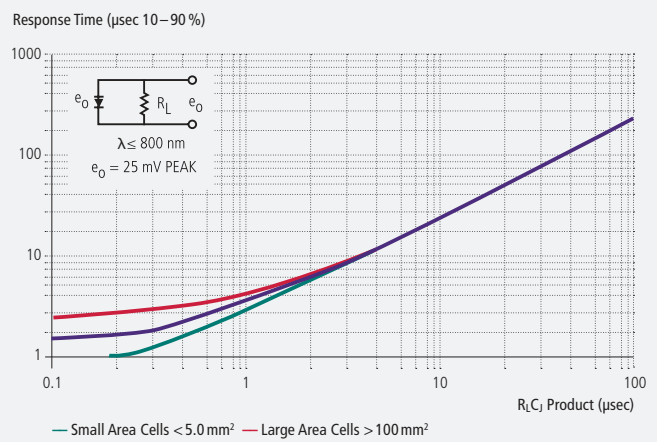

# Fast Response Silicon Photodiodes

SILICON PN PHOTODIODES ■

Silicon Photodiodes – VTP Series



## Silicon Photodiodes – VTP Series

### Applications

- Smoke detection
- Barcode scanning
- Light meters
- Pulse oximeters

### Features and Benefits

- Visible to IR spectral range
- Integral visible rejection filters available
- 1 to 2 % linearity over 7 to 9 decades
- Low dark currents
- High shunt resistance
- Low capacitance

### Product Description

Photodiodes in this series have been designed for low junction capacitance. The lower the capacitance, the faster the response of the photodiode when the RC time constant is your limiting factor. Also, speed can be further increased by reverse biasing the photodiodes. These devices have excellent response in the IR region and are well matched to IR LEDs (VTE series). Some photodiodes are available in packages which incorporate a visible rejection filter, effectively blocking light below 700 nm. Photodiodes made with the VTP process are suitable for operation under reverse bias conditions but may be used in the photovoltaic mode. Typical reverse breakdown voltages are around 140V. Low dark currents under reverse bias are also a feature of this series.

Product Table

### Silicon Photodiodes – VTP Series

Symbol	Package	Active Area mm <sup>2</sup>	Minimum Short Circuit	Maximum Dark	Junction Capacitance	Radiometric Sensitivity @ λ <sub>P</sub>	Spectral Range λ <sub>RANGE</sub> nm	Typical Peak Wavelength λ <sub>P</sub> nm	Typical Noise
			Current @ 100fc, 2850K	Current @ VR = 10V	max C <sub>J</sub>	typ S <sub>R</sub>			Equivalent Power
Unit			μA	(nA)	pF	A/W			W/√Hz
VTP1012H	TO-46	1.6	10	7 @V <sub>R</sub> = 50V	6 @V <sub>R</sub> = 15V	0.55	400-1150	925	8.7 X 10 <sup>-14</sup>
VTP1112H	TO-46 lensed	1.6	30	7 @V <sub>R</sub> = 50V	6 @V <sub>R</sub> = 15V	0.55	400-1150	925	8.7 X 10 <sup>-14</sup>
VTP1188SH	Lensed Ceramic	11	200 (Typical)	30 @V <sub>R</sub> = 10mV	300 @V <sub>R</sub> = 0V	0.55	400-1100	925	-
VTP1232H	T-1 3/4 lensed	2.326	100	25	300 @V <sub>R</sub> = 0V	0.60	400-1100	920	-
VTP1232FH	T-1 3/4 flat	2.326	21	25	100 @V <sub>R</sub> = 0V	0.60	400-1100	920	-
VTP1332H	T-1 3/4 lensed IRT	2.326	75	25	100 @V <sub>R</sub> = 0V	0.60	725-1100	920	-
VTP1332FH	T-1 3/4 flat IRT	2.326	17	25	100 @V <sub>R</sub> = 0V	0.60	725-1100	920	-
VTP3310LAH	T-1 Lensed	0.684	24	35 @V <sub>R</sub> = 50V	25 @V <sub>R</sub> = 3V	0.55	400-1150	925	1.9 X 10 <sup>-13</sup>
VTP3410LAH	T-1 lensed IRT	0.684	15	35 @V <sub>R</sub> = 50V	25 @V <sub>R</sub> = 3V	0.55	700-1150	925	1.9 X 10 <sup>-13</sup>
VTP3420LA	T-1 lensed IRT	1.64	34	35	150 @V <sub>R</sub> = 15V	0.55	700-1150	925	-

Electrical characteristics at T<sub>Ambient</sub> = 25 °C

Product Table

Silicon Photodiodes – VTP Series

Symbol	Unit	Package	Active Area mm <sup>2</sup>	Minimum Short Circuit	Maximum Dark	Junction Capacitance	Radiometric Sensitivity @ λ <sub>P</sub>	Spectral Range λ <sub>RANGE</sub> nm	Typical Peak Wavelength λ <sub>P</sub> nm	Typical Noise Equivalent Power Power W/√Hz
				Current @ 100fc, 2850K μA	Current @ VR = 10V (nA)	max C <sub>J</sub> pF	typ S <sub>R</sub> A/W			
VTP4085H		Ceramic	21	200 (Typical)	100 @V <sub>R</sub> = 0.1V	Typical 350 @V <sub>R</sub> = 0V	0.55	400-1100	925	-
VTP4085SH		Ceramic	21	200 (Typical)	50 @V <sub>R</sub> = 0.1V	Typical 350 @V <sub>R</sub> = 0V	0.55	400-1100	925	-
VTP5050H		TO-5	7.45	40	18 @V <sub>R</sub> = 50	24 @V <sub>R</sub> = 15V	0.55	400-1150	925	1.4 X 10 <sup>-13</sup>
VTP6060H		TO-8	20.6	120	35 @V <sub>R</sub> = 50V	60 @V <sub>R</sub> = 15V	0.55	400-1150	925	1.9 X 10 <sup>-13</sup>
VTP7110H		Lensed Sidelooker	0.684	6	35	25 @V <sub>R</sub> = 3V	0.55	400-1150	925	1.9 X 10 <sup>-13</sup>
VTP8350H		Ceramic	7.45	65	30	50 @V <sub>R</sub> = 3V	0.55	400-1150	925	1.8 X 10 <sup>-13</sup>
VTP8440H		8 mm ceramic	5.16	30	15 @V <sub>R</sub> = 50V	15 @V <sub>R</sub> = 15V	0.55	400-1150	925	1.3 X 10 <sup>-13</sup>
VTP8740STRH		SMT clear	5.269	75	20	50 @V <sub>R</sub> = 3V	0.6	400-1150	925	2.0 X 10 <sup>-13</sup>
VTP9812FH		T-1 3/4 flat	1.548	0.7	10	150 @V <sub>R</sub> = 10V	0.034	400-700	580	-

Electrical characteristics at T<sub>Ambient</sub> = 25 °C

Graph 1

Absolute Spectral Response\*

Radiometric Sensitivity, A/W

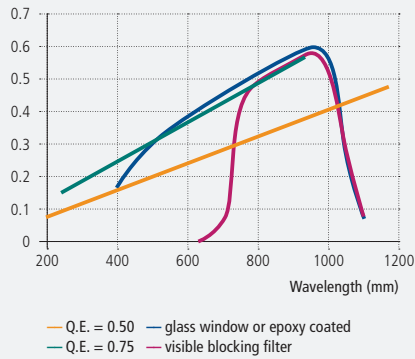

Graph 2

Rise/Fall Times – Non Saturated\*

Response Time (μsec 10–90%)

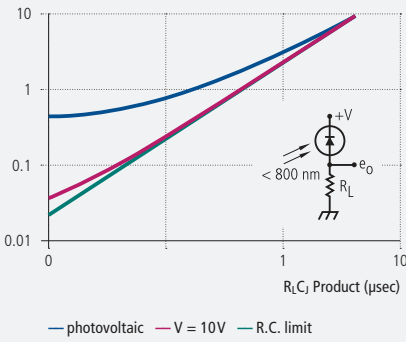

Graph 3

Relative Dark Current vs. Temperature\*

Relative Dark Current

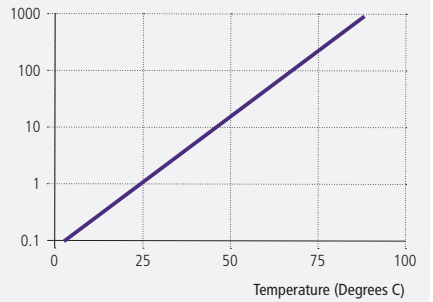

Graph 4

Rel. Junction Capacitance vs. Voltage\*

Relative Capacitance

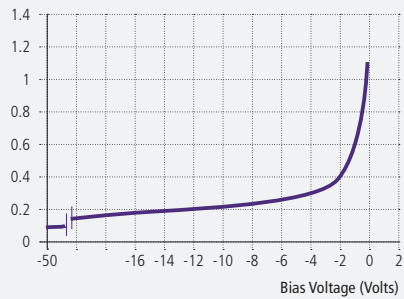

Graph 5

Temp. Coefficient of Light Current vs. Wavelength\*

Temperature Coefficient (%) / Degree (C)

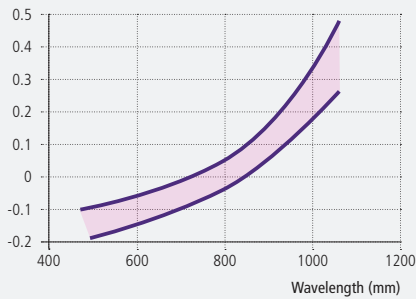

Graph 6

Rel. Short Circuit Current vs. Illumination\*

Relative Short Circuit Current

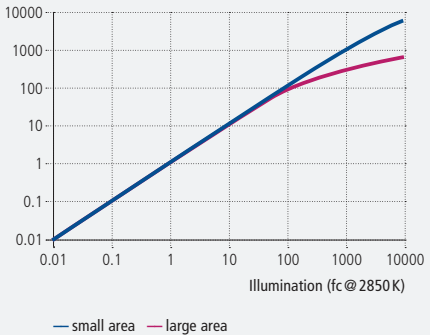

\* Typical characteristic curves @ 25 °C (unless otherwise noted)

# Industry Standard Silicon Photodiodes

SILICON PN PHOTODIODES ■

Silicon Photodiodes – VTD Series



## Silicon Photodiodes – VTD Series

### Applications

- Pulse oximetry
- Automotive

### Features and Benefits

- Alternate source for industry standard photodiodes
- Available in package with integrated IR filtering
- Large area PN available on ceramic package
- RoHs compliant

### Product Description

The VTD series are photodiodes which have been used in many applications as replacement for competitive devices.

Product Table

### Silicon Photodiodes – VTD Series

Symbol Unit	Industry Equivalent	Package	Active Area mm <sup>2</sup>	Short Circuit Current		Maximum Dark	Junction Capacitance	Radiometric Sensitivity @ $\lambda_p$	Spectral Range	Typical Peak Wavelength	Noise Equivalent Power
				min $I_{sc}$ $\mu A$	Current @ $V_R = 10V$ (nA)	typ $C_j$ pF	typ $S_R$ A/W	$\lambda_{RANGE}$ nm	$\lambda_p$ nm	typ NEP W/Hz	
VTD31AAH	CLD31AA	Ceramic	16.73	150 @ 5 mW/cm <sup>2</sup> , 2850K	50 @ $V_R = 15V$		Max 500 @ $V_R = 0V$	0.55	400-1150	860	
VTD205H	SFH205	TO-92	7.41	15 @ 0.5 mW/cm <sup>2</sup> , 940 nm	30		72 @ $V_R = 0V$	0.6	800-1100	925	-
VTD205KH	SFH205K	TO-92	7.41	50 @ 1000 Lux, 2850K	30		72 @ $V_R = 0V$	0.6	400-1100	925	-
VTD206H	SFH206	TO-92	7.41	15 @ 0.5 mW/cm <sup>2</sup> , 940 nm	30		72 @ $V_R = 0V$	0.6	750-1100	925	-
VTD206KH	SFH206K	TO-92	7.41	50 @ 1000 Lux, 2850K	30		72 @ $V_R = 0V$	0.6	400-1100	925	-

Figure 1

Ceramic package VTD31AAH

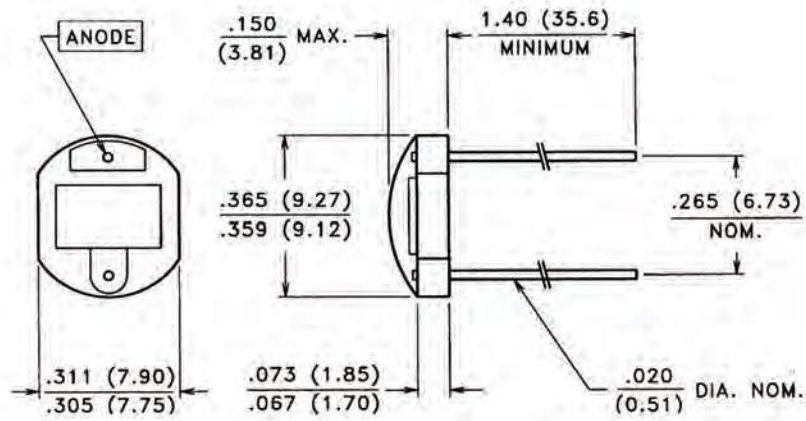
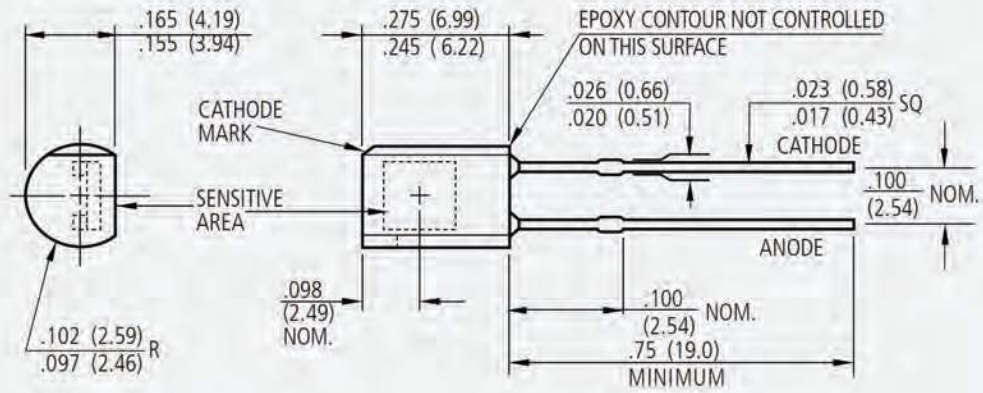

Figure 2

Package Drawing – VTD Series – TO-92 Package





# Infrared Emitting Diodes

INFRARED EMITTING DIODES ■

Infrared Emitting Diodes (IREDs) VTE

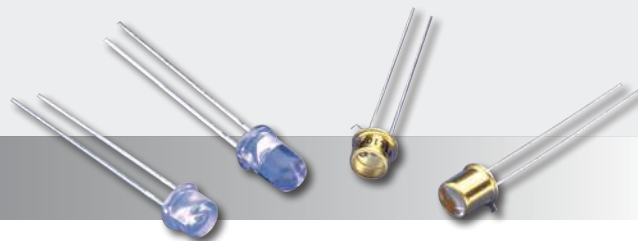

## Infrared Emitting Diodes (IREDs) – VTE

### Applications

- Smoke detection
- Consumer coin readers
- Lottery card readers
- Position sensors – joysticks
- Safety shields
- Encoders – measure speed and direction
- Printers – margin control
- Copiers – monitor paper position or paper stack height

### Features and Benefits

- End and side radiating configurations
- Selection of emission angle spread using molded lenses
- Narrow band of emitted wavelengths
- Minimal heat generation
- Low power consumption

### Product Description

IREDs are solid state light sources emitting in the near infrared part of the spectrum. The emission wavelength is closely matched to the response peak of silicon photodiodes and phototransistors. The product line provides a broad range of mounting lens and power output options. Both end and side radiating cases are available. Wide arrays of emission beam profiles are available. Devices may be operated in either CW or pulsed operating modes.

IREDs can be combined with Excelitas detectors or phototransistors in integrated assemblies for optoisolators, optical switches and retro sensors. Optical isolators are useful when electrical isolation is required, for example to transmit control logic signals to high power switching circuits (which can be noisy). In an optical switch, an object is detected when it passes between the IRED and detector/phototransistor, for example a coin counter. In a retro sensor, an object is detected when the IRED emitted beam is reflected onto the detector/photodetector. The retro sensor is used in applications where the object changes the reflectance, for example detecting the end of a ply wood sheet or other manufactured material.

Our core competencies include: LPE wafer growth; wafer processing of the grown GaAs wafers; assembly using either epoxy die attach; epoxy encapsulation of the IRED LEDs on lead frame; hermetically-sealed package.

Product Table

### Infrared Emitting Diodes (IREDs) – VTE

Part Number		Irradiance			Min. Radiant	Typical Total Peak	Forward Test Current	Max. Forward Voltage	Max Pulsed Forward		Half Power
Symbol		$E_e$ typ.	Distance	Diameter	Intensity	Power	Pulsed	Drop	Current	Wavelength	Beam Angle
Unit	Package	(mW/cm <sup>2</sup> )	(mm)	(mm)	(mW/sr)	(mW)	(mA)	(V)	(mA)	(nm)	
VTE1013H	TO-46	2.7	36	6.4	27	30	1000	2.5	3000	940	±35°
VTE1063H	TO-46	5	36	6.4	49	80	1000	3.5	3000	880	±35°
VTE1113H	TO-46	15	36	6.4	156	30	1000	2.5	3000	940	±10°
VTE1163H	TO-46	28	36	6.4	285	110	1000	3.5	3000	880	±10°
VTE1291-1H	T-1 3/4 lensed (5 mm)	3.3	36	6.4	32	20	100	2	2500	880	±12°
VTE1291-2H	T-1 3/4 lensed (5 mm)	6.5	36	6.4	65	25	100	2	2500	880	±12°
VTE1291W-1H	T-1 3/4 lensed (5 mm)	1.6	36	6.4	16	20	100	2	2500	880	±25°
VTE1291W-2H	T-1 3/4 lensed (5 mm)	3.3	36	6.4	32	25	100	2	2500	880	±25°
VTE3372LAH	T-1 lensed (3 mm)	2.6	10.16	2.1	2	3	20	1.8	2500	880	±10°
VTE3374LAH	T-1 lensed (3 mm)	5.2	10.16	2.1	4.1	5	20	1.8	2500	880	±10°
VTE3375LA	T-1 lensed (3 mm)	"2 (Min.)"	10.16	2.1	-	3	20	1.8	2500	880	±12.5°
VTE3322LAH	T-1 lensed (3 mm)	1.3	10.16	2.1	1	1.5	20	1.6	3000	940	±10°
VTE3324LAH	T-1 lensed (3 mm)	2.6	10.16	2.1	2	2.5	20	1.6	3000	940	±10°
CR10IRD	SMD	-	-	-	-	6.3	50	2.05	800	770	±90°

Graph 1

On Axis Rel. Irradiance T-1/Lateral Packages

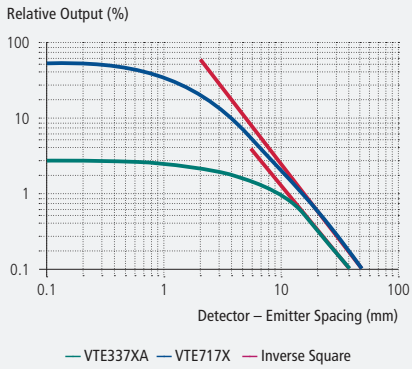

Graph 2

On Axis Relative Irradiance

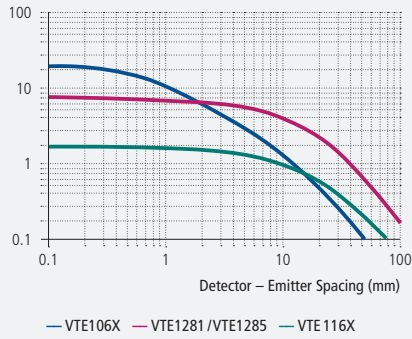

Graph 3

Angular Emission

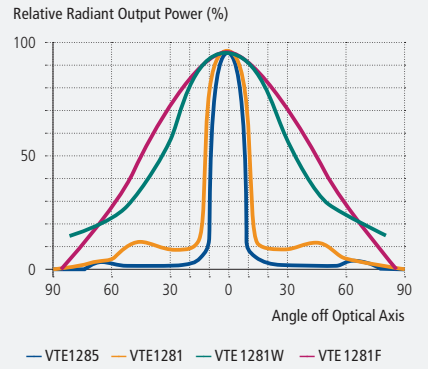
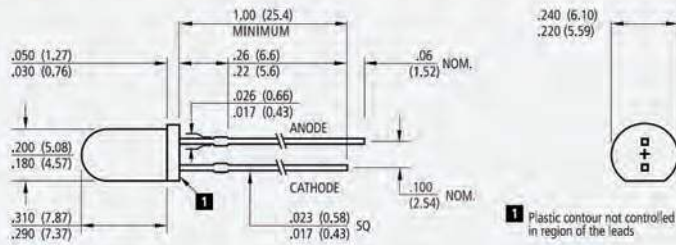

Figure 1

Housing / Package Drawing – VTE1291



VTE1291H



Narrow beam angle T-1¾ package

Figure 2

Housing / Package Drawing – VTE1113H

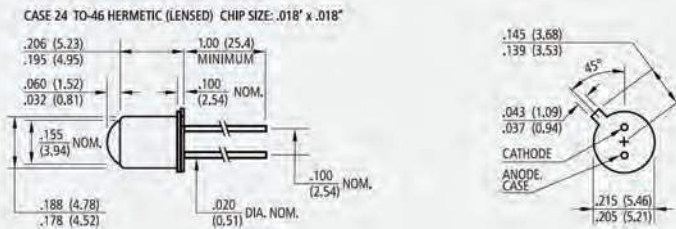

VTE1113H



TO-46 lensed cap

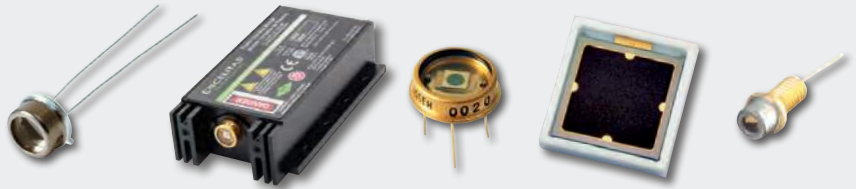

## Excelitas Technologies – Photon Detection Solutions

### Markets & Applications

#### *Life Sciences & Analytical*

- Luminescence and fluorescence for analytical and clinical diagnostics
- Photon counting
- Particle sizing
- PET, CT, MRI scanning

#### *Safety & Security*

- X-ray scanning of luggage, cargo & food
- LiDAR for autonomous vehicles and drones
- Smoke and particle detection
- Safety curtains

#### *High Volume Electronics*

- Laser range finding, industrial and consumer
- Vital signs monitoring for wearables
- Gesture recognition
- Light detection and measurement

### *Engage, Enable, Excel.*

Everything we do revolves around this important principle. We work from Engineer to Engineer to understand your needs and tailor our solutions to exceed these needs and enable you to excel in what you do best.

Excelitas offers a complete suite of solutions for your detection needs, from individual components to plug and play modules. Our products range from high volume C30737 series of avalanche photodiodes (APDs) for range finding, to our high performance C30902 series of reach through APDs, to our outstanding single photon counting module, to pulsed laser diodes, and everything in between.

With more than 50 years of market leading performance in silicon and InGaAs detection capabilities, Excelitas offers proven expertise in customizing to specific needs and help bring your next generation platforms to market. Whether you are working in the UV, visible or near IR, or even looking to detect X-ray or Gamma rays, we have the knowledge and solutions that will help get you to market faster. Excelitas offers one-stop shopping capabilities for both detectors and emitters for those looking to develop range finding or LiDAR-based systems, which helps to simplify the supply chain and provide economies of scale. We are fully vertically integrated giving us maximum flexibility in product design at competitive pricing. Contact us to find out more on how we can help you succeed.









## About Excelitas Technologies

Excelitas Technologies® Corp. is a leading industrial technology manufacturer focused on delivering innovative, market-driven photonic solutions to meet the illumination, optical, optronic, sensing, detection and imaging needs of our OEM and end-user customers. Serving a vast array of applications across biomedical, scientific, semiconductor, industrial manufacturing, safety, security, consumer products, defense and aerospace sectors, Excelitas stands committed to enabling our customers' success in their many various end-markets. Our team consists of more than 7,500 professionals working across North America, Europe and Asia, to serve customers worldwide.

[www.excelitas.com](http://www.excelitas.com)

**Excelitas Technologies**  
22001 Dumberry Road  
Vaudreuil-Dorion, Quebec  
Canada J7V 8P7  
Telephone: (+1) 450.424.3300  
Toll-free: (+1) 800.775.6786  
Fax: (+1) 450.424.3345

**Excelitas Technologies  
GmbH & Co. KG**  
Wenzel-Jaksch-Str. 31  
D-65199 Wiesbaden  
Germany  
Telephone: (+49) 611 492 430  
Fax: (+49) 611 492 165

**Excelitas Technologies**  
8 Tractor Road  
Singapore 627969  
Telephone: (+65) 6775 2022 Main number  
Telephone: (+65) 6770 4366 (Customer Service)  
Fax: (+65) 6778-1752

**EXCELITAS**  
TECHNOLOGIES®

---

For a complete listing of our global offices, visit [www.excelitas.com/ContactUs](http://www.excelitas.com/ContactUs)

© 2022 Excelitas Technologies Corp. All rights reserved. The Excelitas logo and design are registered trademarks of Excelitas Technologies Corp. All other trademarks not owned by Excelitas Technologies or its subsidiaries that are depicted herein are the property of their respective owners. Excelitas reserves the right to change this document at any time without notice and disclaims liability for editorial, pictorial or typographical errors.

D-PD\_CA-Photon Detection Catalog\_2022\_10 V-3.3